



Ihr Technologiepartner für die wirtschaftliche Zerspanung
BOHRUNGSBEARBEITUNG

RAGOTZKY+GÄTJE

Holtener Strasse 288, 24106 Kiel | mail@ragotzkygaetje.de | 0431-389080
ragotzkygaetje.de | shop.ragotzkygaetje.de | spannsysteme-shop.de

HANS TREIBER

Gutenbergstrasse 19, 24558 Henstedt-Ulzburg | 04193-77943
mail@hanstreiber.de | shop.hanstreiber.de | fraeser-shop.de



Werkzeug- und Prozesslösungen verbunden mit umfassenden Dienstleistungen

Wir verstehen uns als Technologiepartner, der Sie bei der Entwicklung von effizienten und ressourcenschonenden Fertigungsprozessen mit Standardwerkzeugen, individuellen Werkzeugkonzepten und der Optimierung von Werkzeugdetails unterstützt. Dabei erfüllen unsere Werkzeuge die Anforderungen an Prozesssicherheit, Präzision und einfaches Handling. Wie? Durch fortschrittliche Entwicklungs- und Konstruktionsmethoden sowie eine Produktion mit modernsten Fertigungsanlagen.

Sie benötigen nicht nur das optimale Werkzeug für Ihre Aufgabe, sondern suchen einen Partner, der die gesamte Planung und Betreuung Ihres Prozesses übernimmt? Auch in diesem Fall sind wir für Sie da. Wir betreuen Sie während aller Produktionsphasen und halten Ihre Fertigung auf Top-Niveau: hochproduktiv, wirtschaftlich und prozesssicher. Zudem bieten wir Ihnen vernetzte Komplettlösungen für alle Peripherieaufgaben rund um den eigentlichen Zerspanungsprozess.

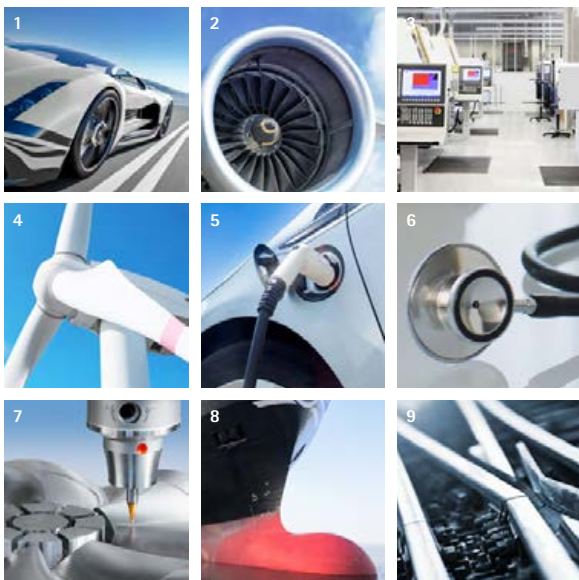

Branchen

- 1 Automotive
- 2 Luft- und Raumfahrt
- 3 Maschinenbau
- 4 Energieerzeugung
- 5 Elektromobilität
- 6 Medizintechnik
- 7 Werkzeug- und Formenbau
- 8 Schiffbau
- 9 Schienenverkehr



Über
5.000
Mitarbeiter weltweit

Nr. 1
Technologieführer
für die zerspanende
Bearbeitung
von kubischen
Bauteilen



Produktbereiche

- 1 Reiben und Feinbohren
- 2 Vollbohren, Aufbohren und Senken
- 3 Fräsen
- 4 Drehen
- 5 Aussteuern
- 6 Spannen
- 7 Einstellen, Messen und Ausgeben
- 8 Services



INHALT

01 Einführung

Kompetenz Bohrungsbearbeitung	6
Programmübersicht	8

02 Vollbohren

Produktübersicht, Baureihenübersicht, Auswahlhilfe, Bezeichnungsschlüssel	12
Vollbohren	
Vollbohren mit Vollhartmetall	29
Vollbohren mit Wechselkopfsystem	183
Vollbohren mit Wendeschneidplatten	239
Anbohren	245
Stufenbohren	257
Tiefbohren	267
Bohrreiben	289
Sonderlösungen	300

03 Reiben und Feinbohren

Produktübersicht	306
Feste Mehrschneidenreibahlen	311
Werkzeuge mit Führungsleisten	477
Lösungen für große Durchmesser	560
Sonderlösungen	572

04 Senken

Kegelsenker	585
-------------------	-----

05 Aufbohren und Drehen

Produktübersicht	596
Sonderlösungen	598
ModulBore	613
Kurzklemmhalter	643
Wendeschneidplatten	663

06 Technischer Anhang

Technischer Anhang	737
--------------------------	-----

KOMPETENZ BOHRUNGSBEARBEITUNG

Für jede Anwendung das optimale Werkzeug

Ausgehend vom Schwerpunkt der Fertigung von Sonderwerkzeugen für kundenspezifische Bearbeitungslösungen hat MAPAL ein umfangreiches Standardprogramm für die Bohrungsbearbeitung entwickelt.

Im Bereich des Bohrens mit Vollhartmetallwerkzeugen gehört MAPAL zu den größten Anbietern weltweit. Das Programm an Vollhartmetallbohrern umfasst Lösungen zur prozesssicheren und wirtschaftlichen Bearbeitung nahezu jedes Werkstoffes und wird komplettiert durch moderne Wechselkopfsysteme für höchste Wirtschaftlichkeit.

Für die Bohrungsfinebearbeitung stehen feste Mehrschneidenreibahlen ebenso im Portfolio wie Werkzeuge mit Führungsleisten, Einschneidenreibahlen, das EasyAdjust-System (EA-System) sowie präzisionsgeschliffene Wendschneidplatten und Lösungen für große Durchmesser bis 400 mm.

Werkzeuge mit Wendschneidplatten nehmen im Bereich des Aufbohrens eine führende Rolle ein. Besonders wirtschaftlich sind die positiven radialen Wendschneidplatten zum Aufbohren und Drehen. Für höchste Anforderungen beim Aufbohren stehen tangential Wendschneidplatten zur Verfügung.



Vollbohren



MAPAL bietet ein umfangreiches Standardprogramm an Bohrern aus Vollhartmetall für alle Bearbeitungsaufgaben. So umfasst das Portfolio neben zwei- und dreischneidigen Werkzeugen zum Vollbohren, auch Anbohrer, Stufenbohrer, Tiefbohrer sowie Bohrreibahlen zum Bohren und Reiben in einem Arbeitsgang. Darüber hinaus sind Vollbohrer mit Wechselkopfsystem und Wendschneidplatten verfügbar.

Egal für welchen Werkstoff, ob Gusswerkstoffe, Nichteisenmetalle, Stähle, moderne Leichtbauwerkstoffe oder schwer zu zerspanende Werkstoffe, MAPAL bietet den passenden Bohrer.

Reiben und Feinbohren



Reiben und Feinbohren sind die gebräuchlichsten Verfahren zum Feinbearbeiten von Bohrungen und überzeugen durch präziseste Ergebnisse. Je nach Komplexität der Bearbeitung und den Anforderungen an Präzision und Oberfläche bietet MAPAL die passende Lösung.

Feste Mehrschneidenreibahlen ermöglichen hohe Vorschubwerte und reduzieren die Bearbeitungszeit enorm. Das Portfolio umfasst Monoblockreibahlen aus Hartmetall, Cermet oder HSS sowie HPR-Wechselkopfreibahlen mit hochgenauer HFS-Trennstelle. Für die Bearbeitung großer Durchmesser bis 400 mm steht ein modulares HPR-Programm zur Verfügung.

Für höchste Präzision sorgen Werkzeuge mit Führungsleisten. Das Standardprogramm beinhaltet neben Einschneidenreibahlen unter anderem das EasyAdjust-System für das einfache Einstellen von Werkzeugen in kürzester Zeit sowie präzisionsgeschliffene Wendschneidplatten.

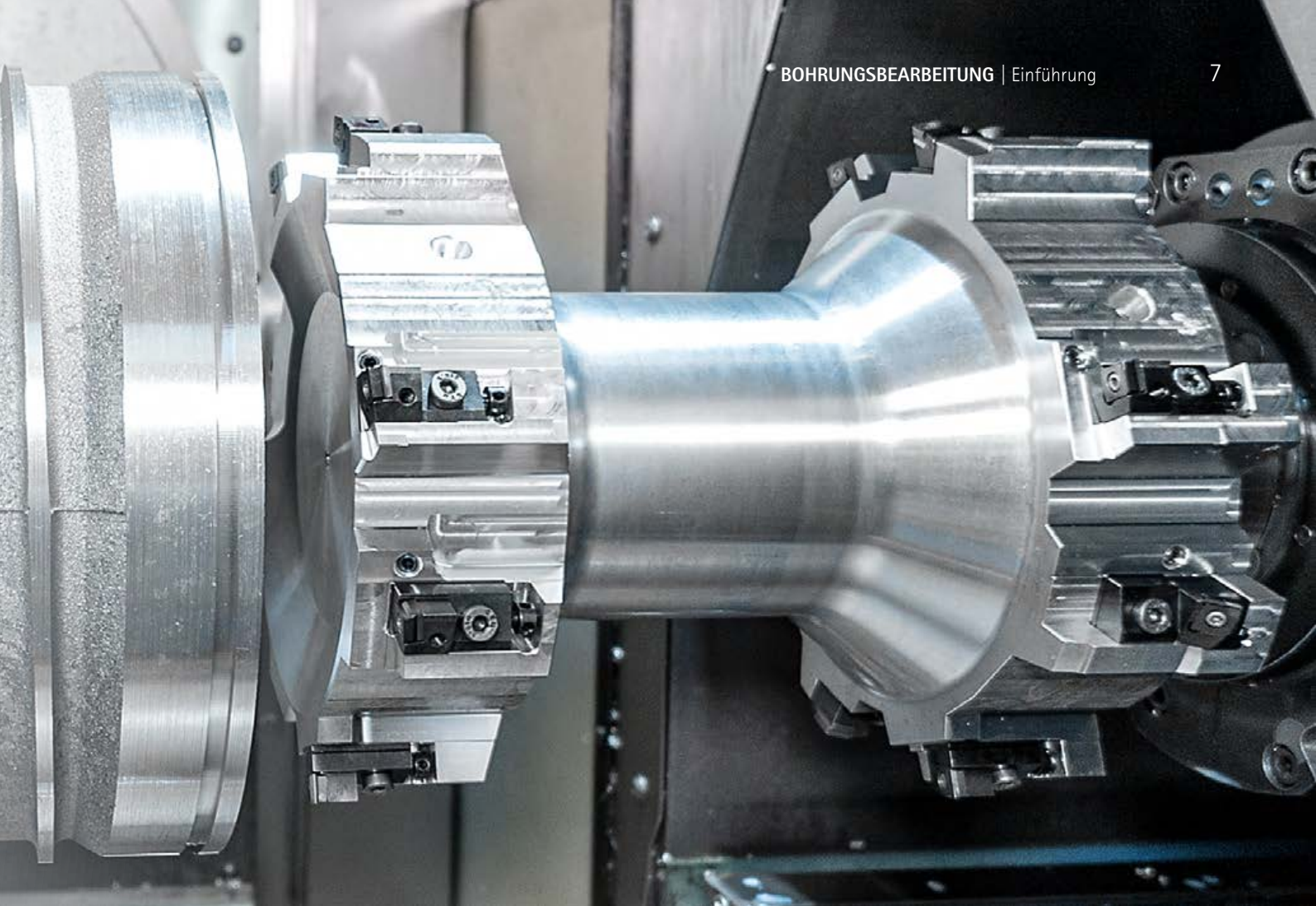

Senken



Mit extrem ungleich geteilten Kegelsenkern hat MAPAL einen neuen Standard im Bereich des Senkens begründet. Die Kegelsenker, die als HSS- und Vollhartmetallvariante zur Verfügung stehen, arbeiten mit deutlich reduzierten Axial- und Radialkräften im Vergleich zu herkömmlichen Kegelsenkern. Die daraus resultierenden Vorteile sind eine bessere Oberfläche, hohe Werkzeugstandzeiten und optimale Schrauben- und Nietlochverbindungen.

Aufbohren und Drehen



MAPAL bietet unterschiedliche Konzepte und Werkzeuglösungen zum Aufbohren und Drehen. Auf unterschiedliche Anforderungen hin optimiert, bieten sie Flexibilität, Wirtschaftlichkeit und Prozesssicherheit auch bei anspruchsvollen Bearbeitungen. Das Portfolio beinhaltet unter anderem Kurzklemmhalter, radiale und tangentiale Wendeschneidplatten, individuelle Lösungen mit PKD-Schneiden oder -Wendeschneidplatten und das ModulBore-Programm zum Aufbohren, das spezifisch auf die jeweiligen Kundenanforderungen angepasst wird.

PROGRAMMÜBERSICHT



1 | Vollbohren

- 1.1 Vollbohren mit Vollhartmetall (ab Seite 29)
- 1.2 Vollbohren mit Wechselkopfsystem (ab Seite 183)
 - Vollbohren mit Wendeschneidplatten (ab Seite 239)
- 1.3 Anbohren (ab Seite 245)
- 1.4 Stufenbohren (ab Seite 257)
- 1.5 Tiefbohren (ab Seite 267)
- 1.6 Bohrreiben (ab Seite 289)

2 | Reiben und Feinbohren

- 2.1 Hochleistungsreibahle | FXR (ab Seite 316)
- 2.2 Wechselkopfreibahle | HPR (ab Seite 368)
 - Bestückte Hochleistungsreibahlen | MOR/MRF (ab Seite 350)
- 2.3 Einschneidenreibahle (ab Seite 478)
- 2.4 EasyAdjust-System (ab Seite 514)
- 2.5 Lösungen für große Durchmesser (ab Seite 560)



3 | Senken

3.1 Kegelsenker (ab Seite 586)

4 | Aufbohren und Drehen

4.1 Sonderlösungen mit PKD (ab Seite 598)

4.2 Sonderlösungen mit Wendeschneidplatten (ab Seite 604)

4.3 ModulBore (ab Seite 613)

4.4 Kurzklemmhalter (ab Seite 643)

4.5 Wendeschneidplatten (ab Seite 663)

VOLLBOHREN

Optimale Bohrer für nahezu alle Anwendungen und Werkstoffe.





PRODUKTÜBERSICHT

Zum Vollbohren bietet MAPAL ein umfangreiches Standardprogramm für nahezu alle Bearbeitungsaufgaben bestehend aus Vollhartmetallbohrern sowie Wechselkopfbohrern. Das Programm umfasst Universalbohrer sowie Werkzeuge zur Bearbeitung von Guss, Nichteisenmetallen, Stählen, Leichtbau- oder schwer zu zerspanende Werkstoffe. Zudem sind Lösungen zur Hochgeschwindigkeits- und Hochvorschubbearbeitung mit drei Schneiden Teil des Angebots.

Für spezifische Kundenanforderungen bietet MAPAL speziell ausgelegte PKD-bestückte Bohrer. Auch die Vollhartmetall- und die Wechselkopfbohrer können individuell angepasst werden. Für alle Werkzeuge garantiert der weltweite Nachschleifservice in Originalqualität höchste Wirtschaftlichkeit.







Basic Line:
Universalwerkzeuge, breites Anwendungsgebiet, niedrige Anschaffungskosten







Performance Line:
Hochleistungswerkzeuge, breites Anwendungsgebiet, hohe Produktivität in der Serienfertigung



Expert Line:
Spezialistenwerkzeuge für ausgewählte Anwendungen, maximale Präzision und Produktivität

Vollbohrer			Anbohrer	
				
<p>Vollbohren mit Vollhartmetall</p> <p>Vollbohrer aus Vollhartmetall für nahezu alle Werkstoffe in drei unterschiedlichen Leistungsklassen.</p> <ul style="list-style-type: none"> - MEGA-Drill - Zweischneidige Vollbohrer mit abgestimmter Beschichtung und Geometrie auf den jeweiligen Werkstoff - Tritan-Drill - Dreischneidige Vollbohrer für höchsten Vorschub mit selbstzentrierender Querschneide für schwierige Bohrsituationen - ECU-Drill - Extrem wirtschaftliche Programmwahl mit sehr gutem Preis-Leistungs-Verhältnis <p>Ø-Bereich: 0,50 - 25,00 mm Bohrtiefe: 3xD 4xD 5xD 6xD 8xD 12xD</p> <p>P M K N C S H</p>	<p>Vollbohren mit Wechselkopfsystem</p> <p>Vollbohren mit minimiertem Hartmetalleinsatz bei höchster Stabilität u. Präzision.</p> <ul style="list-style-type: none"> - Schneidplattenbohrer QTD - Wirtschaftliches System mit austauschbaren Schneidplatten - Wechselkopfbohrer TTD - Zweischneidiger Wechselkopfbohrer mit fünf verschiedenen Bohrköpfen - Wechselkopfbohrer TTD-Tritan - Bis zu doppelter Vorschub gegenüber zweischneidigen Wechselkopfbohrern. Hohe Prozesssicherheit und Stabilität auch bei schwierigen Bohrsituationen <p>Ø-Bereich: 9,00 - 50,00 mm Bohrtiefe: 1xD 1,5xD 3xD 5xD</p> <p>P M K N C S H</p>	<p>Vollbohren mit Wendschneidplatten</p> <p>Vollbohren von Aluminium mit CVD-diamantbeschichteten Wendschneidplatten.</p> <ul style="list-style-type: none"> - Dreischneidige CVD-diamantbeschichtete Wendschneidplatten für höchste Produktivität und Wirtschaftlichkeit - Vollbohren von AISi1 bis AISi12 - Mit Innenkühlung, auch MMS möglich - Kundenspezifische Lösungen für: Ø 16 - 54,9 mm <p>Ø-Bereich: 16,00 - 54,90 mm Bohrtiefe: Bis 3xD</p> <p>N</p>	<p>Anbohren</p> <p>Herstellung von Zentrierbohrungen nach DIN.</p> <ul style="list-style-type: none"> - Tritan-Spot-Drill - Dreischneidiger Anbohrer für anspruchsvolle Anbohrsituationen, speziell abgestimmt auf dreischneidige Bohrer - ECU-Centre-Drill - Herstellung DIN-gerechte Zentrierbohrungen in rotations-symmetrischen Bauteilen - CPD-Spot-Drill - Zweischneidiger Zentrierbohrer mit CFS-Trennstelle <p>Ø-Bereich: 0,50 - 20,00 mm</p> <p>P M K S</p>	
Seite 29	Seite 183	Seite 239	Seite 245	



Stufenbohrer	Tiefbohrer	Bohrreibahle	Sonderlösungen
			
<p>Stufenbohren</p> <p>Herstellung von Kernlöchern und Anfasungen für metrische Gewinde.</p> <ul style="list-style-type: none"> - Tritan-Step-Drill – Dreischneidiger Stufenbohrer mit selbstzentrierender Querschnide für die Bearbeitung von Gewindekernlöchern ohne Pendelbewegung - MEGA-Step-Drill – Zweischneidiger Stufenbohrer für die Herstellung von Gewidekernlöchern <p>Ø-Bereich: 2,50 - 17,50 mm</p> <p>P M</p>	<p>Tiefbohren</p> <p>Prozesssichere und effiziente Herstellung tiefer Bohrungen bis 40xD.</p> <ul style="list-style-type: none"> - MEGA-Deep-Drill – Tiefbohrer mit Innenkühlung für die prozesssichere Bearbeitungen tiefer Bohrungen bis 40xD - MEGA-Pilot-Drill – Pilotbohrer speziell auf MEGA-Deep-Drill abgestimmt <p>Ø-Bereich: 1,00 - 16,00 mm</p> <p>Bohrtiefe: 12xD 20xD 25xD 30xD 40xD</p> <p>P M K N</p>	<p>Bohrreiben</p> <p>Bohren und Reiben in einem Arbeitsgang.</p> <p>Tritan-Drill-Reamer:</p> <ul style="list-style-type: none"> - Genaute Lösung zum Bohrreiben - Drei Schneiden und sechs Führungsfasen - Selbstzentrierende Querschnide für verbessertes Anbohrverhalten - Hohe Positionsgenauigkeit - Optimale Rundheit - Mit Innenkühlung - Toleranzausführungen ±0,003 mm und H7 <p>Ø-Bereich: 3,80 - 20,05 mm</p> <p>Bohrtiefe: 3xD 5xD</p> <p>P K N</p>	<p>Sonderlösungen</p> <ul style="list-style-type: none"> - Anwendungsspezifische Sonderlösungen im Bereich Vollhartmetall-Bohrer - Optimal auf die Bearbeitung ausgelegt PKD-bestückte Bohrer für die Bearbeitung von Aluminium und CFK - Portfolio reicht vom einfachen geraden genuteten PKD-bestückten Bohrer bis zu spiralisierten PKD-bestückten Stufenbohrern - Weltweit führendes Kompetenzzentrum für PKD-Werkzeuge in Pforzheim
<p>Seite 257</p>	<p>Seite 267</p>	<p>Seite 289</p>	<p>Seite 300</p>

BAUREIHENÜBERSICHT

Vollbohren mit Vollhartmetall

MEGA-BOHRER

Zweischneidige Vollbohrer mit abgestimmter Beschichtung und Geometrie auf den jeweiligen Werkstoff.



MEGA-Drill

- Auf jeden Werkstoff individuell abgestimmte Beschichtung und Geometrie
- Breites Anwendungsfeld
- Beinhaltet Tiefbohrer, Stufen- und Microbohrer für jeden Anwendungsfall

Produktklasse:

Perfor-
mance
LINE

Materialeigung:

P M K
N C S H

Bohrtiefe:

3xD 4xD
5xD 8xD 12xD

Ø-Bereich: 0,50 - 25,00 mm



MEGA-Speed-Drill

- Hochgeschwindigkeitsbohrer mit zwei Schneiden
- Feinstgeschliffenes Nutprofil für schnelle Spanabfuhr
- Drei Führungsfasen vermindern Reibung und Vibration

Produktklasse:

Expert
LINE

Materialeigung:

P M
K S

Bohrtiefe:

3xD 8xD
8xD 12xD

Ø-Bereich: 3,00 - 20,00 mm



MEGA-Quadro-Drill

- Vier Führungsfasen für maximale Bohrungsqualität, Koaxialität und Positionsgenauigkeit
- Optimale Rundheit und Durchmesser-toleranzen

Produktklasse:

Perfor-
mance
LINE

Materialeigung:

P
K

Bohrtiefe:

5xD
8xD 12xD

Ø-Bereich: 3,00 - 20,00 mm



MEGA-180°-Drill

- Vollbohren mit ebenem Bohrungsgrund
- Anbohren an geneigten Flächen bis 45°

Produktklasse:

Expert
LINE

Materialeigung:

P M
K N

Bohrtiefe:

3xD
5xD

Ø-Bereich: 3,00 - 20,00 mm



TRITAN-BOHRER

Dreischneidige Vollbohrer für höchsten Vorschub mit selbstzentrierender Querschneide für schwierige Bohrsituationen.



ECU-BOHRER

Extrem wirtschaftliche Programmauswahl mit sehr gutem Preis-Leistungs-Verhältnis.



Tritan-Drill

- Robuste Werkzeuge mit stabilen Schneidecken
- Keine Pendelbewegungen bei der Bearbeitung
- Optimale Spanabfuhr



Produktklasse:



Materialeigung:



Bohrtiefe:

3xD	8xD
8xD	12xD

Ø-Bereich: 4,00 - 20,00 mm

ECU-Drill

- Wirtschaftliche Programmauswahl
- Schneidstoff und Beschichtungen speziell auf Werkstoff abgestimmt



Produktklasse:



Materialeigung:



Bohrtiefe:

3xD	5xD
8xD	12xD

Ø-Bereich: 3,00 - 20,00 mm

AUSWAHL EINES BOHRERS

Schritt für Schritt zum richtigen Bohrer

Sie suchen zum Beispiel einen Vollbohrer für die Bearbeitung von gehärtetem Stahl?
Diese Auswahlhilfe führt Sie Schritt für Schritt zum richtigen Bohrer.

1	Anwendung	Wählen Sie Ihre Hauptanwendung.	➤	 Vollbohren	 Anbohren
2	Design	Wählen Sie Ihre bevorzugte Werkzeugausführung.	➤	 Monolithisch	 Trennstelle QTS
3	Produktklasse	Entscheiden Sie sich für eine Produktklasse.	➤	 Basic LINE Basic Line: Universalwerkzeuge, breites Anwendungsgebiet, niedrige Anschaffungskosten	
4	Materialeignung	Bestimmen Sie Ihren Werkstückstoff gemäß den MAPAL Zerspanungsgruppen (MZG). Die MZG finden Sie auf der Klappseite am Ende des Katalogs.	➤	 P Stahl	 M Rostfreier Stahl
5	Bauteilmerkmale	Prüfen Sie die Anforderungen, die durch die Bohreigenschaften an Ihr Werkzeug gestellt werden.	➤	 Hochvorschubbearbeitung	 Hochgeschwindigkeitsbearbeitung
			➤	 IT7 Erreichbare Bohrungstoleranz $\geq IT$	 H7 Vorzugsbaureihe in H7
6	Ausführung	Überprüfen Sie, ob die Geometriemerkmale Ihren Anforderungen entsprechen.	➤	Durchmesserbereich	Schneidenanzahl
7	Produkt	Wählen Sie Ihren Bohrer. Produkte der lagerhaltigen Vorzugsbaureihe sind kurzfristig lieferbar während Produkte mit konfigurierbaren Merkmalen innerhalb vorgegebener Grenzen frei konfiguriert werden können.	➤	 Lagerhaltige Vorzugsbaureihe	



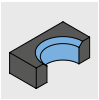

Stufenbohren

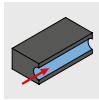

Tiefbohren

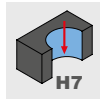

Bohrreiben



Trennstelle TTS



Trennstelle CFS



Mit Wende-schneidplatte



Performance Line:
Hochleistungswerkzeuge, breites Anwendungsgebiet, hohe Produktivität in der Serienfertigung



Expert Line:
Spezialistenwerkzeuge für ausgewählte Anwendungen, maximale Präzision und Produktivität



Gusseisen



Nichteisen-metalle und Kunststoffe

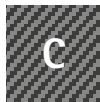

Verbundwerkstoffe



Super-legierungen und Titan



Gehärteter Stahl und Stahlguss

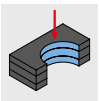

Paket-bohren

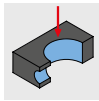

Quer-bohren

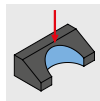

Schräger Bohrungs-eintritt

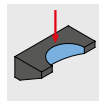

Schräger Bohrungs-austritt

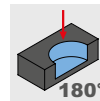

Ebener Bohrungs-grund



Toleranz Werkzeug-schleifdurchmesser



Maximale Bohrtiefe

Anzahl Führungsfasen



Kühlmittelzufuhr



Produkt mit konfigurierbaren Merkmalen

BOHRUNGSBEARBEITUNG | Vollbohren 19

Schritt 1: Anwendung Schritt 2: Design Schritt 3: Produktklasse Schritt 4: Materialeignung Schritt 5: Bauteilmerkmale Schritt 6: Ausführung

Ausführung				Produkt		
ø [mm]	z	η_{FF}^*		Produktname	Spezifikation	Seite
3 - 25	2	2	✓	MEGA-Drill-Steel-Plus	SCD600, 601	51
2,8 - 20	2	2	✓	MEGA-Drill-Inox	SCD120, 121	129
2,8 - 19,05	2	2	✓	MEGA-Drill-Alu	SCD131	151
2,8 - 16	2	2	✓	MEGA-Drill-Hardened	SCD140	82
0,5 - 12	2	2		MEGA-Drill-Composite-MD	SCD250	156
0,8 - 2,9	2	2	✓	MICRO-Drill-Steel	SCD371	79

6 → **7** → **82**

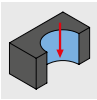









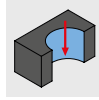









Vollbohren (1/2)

Design	Produkt-klasse	Materialeignung						Bohrungseigenschaft							Bohrtiefe						
		P	M	K	N	C	S	H	HFC	HSC	180°	Toleranz	3xD	4xD	5xD	6xD	8xD	12xD			
Performance LINE	Performance LINE	■	■	■	■	■	■	■			✓	✓			IT9	✓		✓		✓	
		■	■	■	■	■	■	■							IT9	✓		✓		✓	
		■	■	■	■	■	■	■							IT9	✓		✓		✓	✓
		■	■	■	■	■	■	■							IT9		✓				
		■	■	■	■	■	■	■							IT9			✓			
		■	■	■	■	■	■	■							IT9			✓		✓	✓
		■	■	■	■	■	■	■					✓		IT9			✓		✓	✓
Expert LINE	Expert LINE	■	■	■	■	■	■	■	✓		✓	✓	✓	✓	IT9			✓		✓	✓
		■	■	■	■	■	■	■	✓		✓	✓	✓	✓	IT9	✓		✓		✓	✓
		■	■	■	■	■	■	■		✓					IT9	✓		✓		✓	
		■	■	■	■	■	■	■		✓					IT9	✓		✓		✓	✓
		■	■	■	■	■	■	■		✓					IT9			✓		✓	✓
		■	■	■	■	■	■	■		✓					IT9			✓			
		■	■	■	■	■	■	■						✓	IT9	✓		✓			
		■	■	■	■	■	■	■						✓	IT9	✓		✓			
		■	■	■	■	■	■	■							IT9			✓			
Basic LINE	Basic LINE	■	■	■	■	■	■	■							IT9		✓		✓		
		■	■	■	■	■	■	■							IT9	✓		✓		✓	✓
		■	■	■	■	■	■	■							IT9			✓		✓	

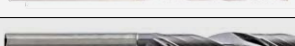
■ bestens geeignet

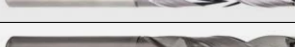
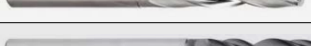
■ bedingt geeignet

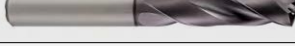
Schritt 1:
AnwendungSchritt 2:
DesignSchritt 3:
ProduktklasseSchritt 4:
MaterialeignungSchritt 5:
BauteilmerkmaleSchritt 6:
Ausführung

	Ausführung				Produkt			
	ø [mm]	z	n _{FF} *		Produktname	Spezifikation		Seite
	3 - 25	2	2	✓	MEGA-Drill-Steel-Plus	SCD600, 601		51
	2 - 20	2	2	✓	MEGA-Drill-Inox	SCD120, 121		129
	2,8 - 20	2	2	✓	MEGA-Drill-Alu	SCD131		151
	2,55 - 20	2	2		MEGA-Drill-Hardened	SCD140		82
	0,5 - 12	2	2		MEGA-Drill-Composite-MD	SCD250		156
	0,8 - 2,99	2	2	✓	MICRO-Drill-Steel	SCD371		79
	3 - 20	2	4	✓	MEGA-Quadro-Drill-Plus	SCD610, 611		70
	4 - 20	3	3	✓	Tritan-Drill-Uni-Plus	SCD631		30
	4 - 20	3	3	✓	Tritan-Drill-Steel	SCD661		85
	3 - 20	2	3	✓	MEGA-Speed-Drill-Uni	SCD221		36
	3 - 20	2	3	✓	MEGA-Speed-Drill-Steel	SCD621		95
	3 - 20	2	3	✓	MEGA-Speed-Drill-Inox	SCD411		142
	3 - 20	2	3	✓	MEGA-Speed-Drill-Iron	SCD421		150
	3 - 20	2	4	✓	MEGA-180°-Drill	SCD231		105
	3 - 20	2	4	✓	MEGA-180°-Drill-Alu	SCD241		160
	3 - 12	2	2		MEGA-Drill-Composite-UDX	SCD270, 271		158
	3 - 20	2	2	✓	ECU-Drill-Uni	SCD350, 351		42
	3 - 20	2	2	✓	ECU-Drill-Steel	SCD360, 361		111
	4,8 - 11,6	2	4	✓	ECU-G-Drill	SCD211		164



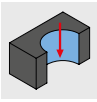





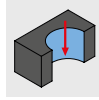





* n_{FF} = Anzahl der Führungsfasen

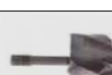

Vollbohren (2/2)

Design	Pro- dukt- klasse	Materialeignung						Bohrungseigenschaft							Bohrtiefe					
		P	M	K	N	C	S	H	HFC	HSC	180°	Toleranz	1xD	1,5xD	3xD	5xD	8xD	12xD		
	Performance LINE	■		■									IT9	✓		✓	✓	✓	✓	
		■		■									IT9	✓		✓	✓	✓	✓	
		■	■	■	■		■						IT9	✓		✓	✓	✓	✓	
					■								IT9	✓		✓	✓	✓	✓	
						■							IT9	✓		✓	✓	✓	✓	
	Expert LINE	■		■					✓		✓	✓	✓	✓		✓	✓	✓		
	Performance LINE	■		■						✓	✓		IT10		✓	✓	✓	✓	✓	
		■		■									IT10		✓	✓	✓	✓	✓	
		■		■									IT10		✓	✓	✓	✓	✓	
		■	■	■	■		■						IT10		✓	✓	✓	✓	✓	
					■								IT10		✓	✓	✓	✓	✓	
						■							IT10		✓	✓	✓	✓	✓	
	Performance LINE				■								IT9	✓	✓	✓				

Schritt 1:
AnwendungSchritt 2:
DesignSchritt 3:
ProduktklasseSchritt 4:
MaterialeignungSchritt 5:
BauteilmerkmaleSchritt 6:
Ausführung

	Ausführung				Produkt			
	ø [mm]	z	η _{FF} *		Produktname	Spezifikation		Seite
	12 - 45	2	4	✓	Wechselbohrkopf TTD Uni-Plus	01P-Uni-Plus		206
	12 - 45	2	3	✓	Wechselbohrkopf TTD Steel	04-Steel		207
	12 - 45	2	3	✓	Wechselbohrkopf TTD Inox	02-Inox		209
	12 - 45	2	4	✓	Wechselbohrkopf TTD Iron	05-Iron		211
	12 - 45	2	4	✓	Wechselbohrkopf TTD Alu	03-Alu		212
	12 - 32,49	3	3	✓	Wechselbohrkopf TTD-Tritan Uni	01-Uni		230
	9 - 50	2	2	✓	Schneidplatte QTD Steel	01-Steel		186
	14 - 32	2	2	✓	Schneidplatte QTD Steel-Pyramid	05-Pyramid		188
	10 - 33	2	2	✓	Schneidplatte QTD Uni, Form EK	10-Uni		190
	9 - 50	2	2	✓	Schneidplatte QTD Inox	02-Inox		191
	9 - 50	2	2	✓	Schneidplatte QTD Iron	04-Iron		193
	9 - 50	2	2	✓	Schneidplatte QTD Alu	03-Alu		194
	16 - 54,9	1	4	✓	Wendeschneidplatte WOGT	WOGT-X40		241

* η_{FF} = Anzahl der Führungsfasen

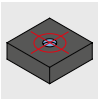

Anbohren

Design	Produkt-klasse	Materialeignung						Bohrungseigenschaft							Bohrtiefe					
		P	M	K	N	C	S	H	HFC	HSC	180°	Toleranz	1xD	1,5xD	3xD	5xD	8xD	12xD		
	Expert LINE	■	■	■	■	■	■	■												
	Basic LINE	■	■	■	■	■	■	■												
	Basic LINE	■	■	■	■	■	■	■												

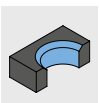

Stufenbohren

Design	Produkt-klasse	Materialeignung						Bohrungseigenschaft							Bohrtiefe						
		P	M	K	N	C	S	H	HFC	HSC	180°	Toleranz	1xD	1,5xD	3xD	5xD	8xD	12xD			
	Expert LINE	■	■	■	■	■	■	■	✓											IT9	
	Performance LINE	■	■	■	■	■	■	■													IT9

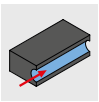

Tiefbohren

Design	Produkt-klasse	Materialeignung						Bohrungseigenschaft							Bohrtiefe							
		P	M	K	N	C	S	H	HFC	HSC	180°	Toleranz	15xD	20xD	25xD	30xD	40xD					
	Performance LINE	■	■	■	■	■	■	■														
		■	■	■	■	■	■	■														IT9
		■	■	■	■	■	■	■														IT9

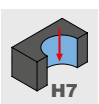

Bohrreiben

Design	Produkt-klasse	Materialeignung						Bohrungseigenschaft							Bohrtiefe							
		P	M	K	N	C	S	H	HFC	HSC	180°	Toleranz	1xD	1,5xD	3xD	5xD	8xD	12xD				
	Expert LINE	■	■	■	■	■	■	■														IT7

■ bestens geeignet

▣ bedingt geeignet

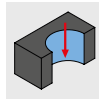
Schritt 1:
AnwendungSchritt 2:
DesignSchritt 3:
ProduktklasseSchritt 4:
MaterialeignungSchritt 5:
BauteilmerkmaleSchritt 6:
Ausführung

Ausführung				Produkt			
ø [mm]	z	η _{FF} *		Produktname	Spezifikation		Seite
4 - 20	3	0		Tritan-Spot-Drill-Steel	SCD670		246
0,5 - 2,5	2	2		ECU-Centre-Drill	SCD450		248
8 - 20	2	0		CPD-Spot-Drill	CPD100		249

Ausführung				Produkt			
ø [mm]	z	η _{FF} *		Produktname	Spezifikation		Seite
3,98 - 17,50	3	3	✓	Tritan-Step-Drill-Steel	SCD561		258
2,5 - 14	2	2	✓	MEGA-Step-Drill-Steel-Plus	SCD590, 591		259

Ausführung				Produkt			
ø [mm]	z	η _{FF} *		Produktname	Spezifikation		Seite
1 - 3	2	2	✓	MEGA-Pilot-Drill	SCD581		268
1 - 16	2	4	✓	MEGA-Deep-Drill	SCD171		269
3 - 12	2	4	✓	MEGA-Deep-Drill-Alu	SCD181		278

Ausführung				Produkt			
ø [mm]	z	η _{FF} *		Produktname	Spezifikation		Seite
3,80 - 20,05	3		✓	Tritan-Drill-Reamer	SDR301		292

* η_{FF} = Anzahl der Führungsfasen

Bezeichnungsschlüssel

Vollhartmetallbohrer

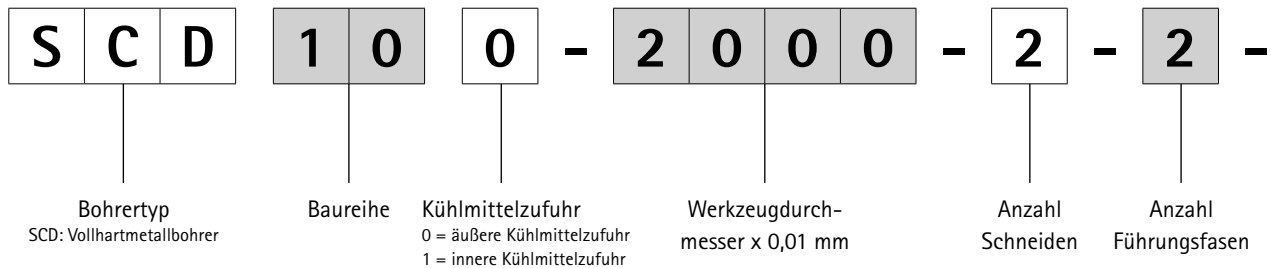

Bohrreibahle

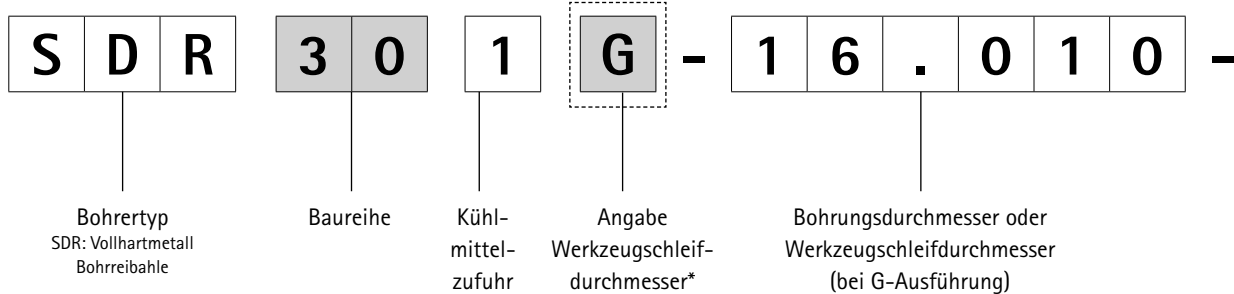

Wechselsystem QTD und TTD

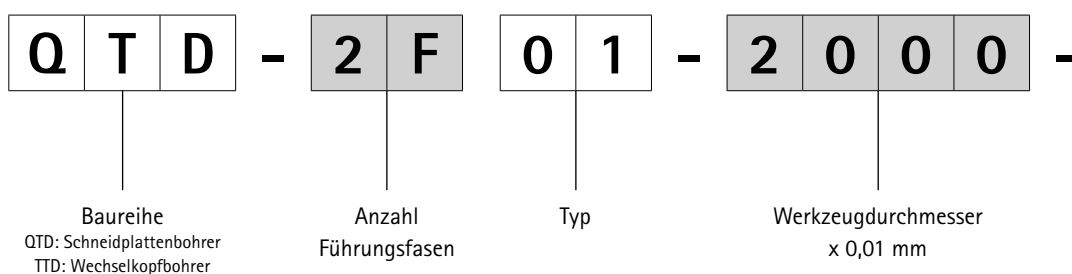

* Stelle wird nur bei G-Ausführung belegt

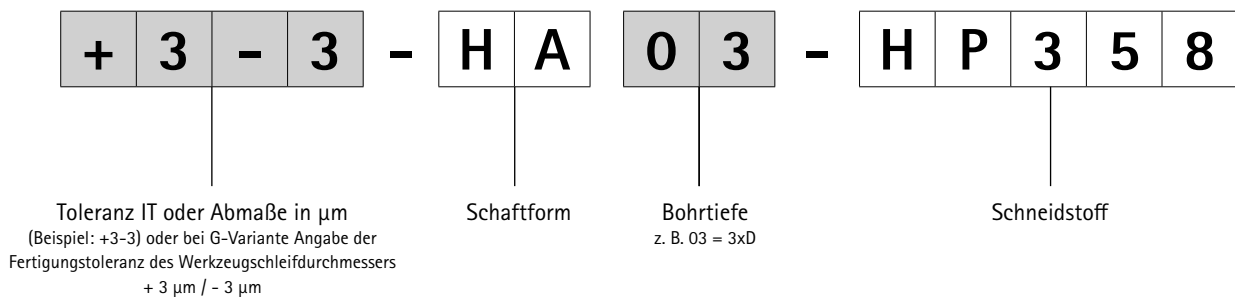
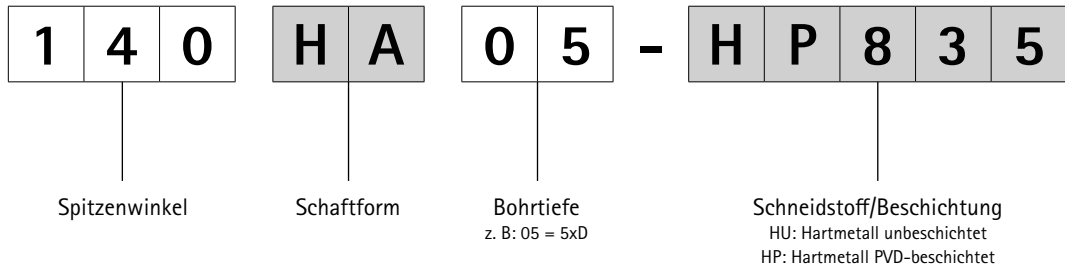

Bezeichnungsschlüssel

Wechselsystem TTD-Tritan

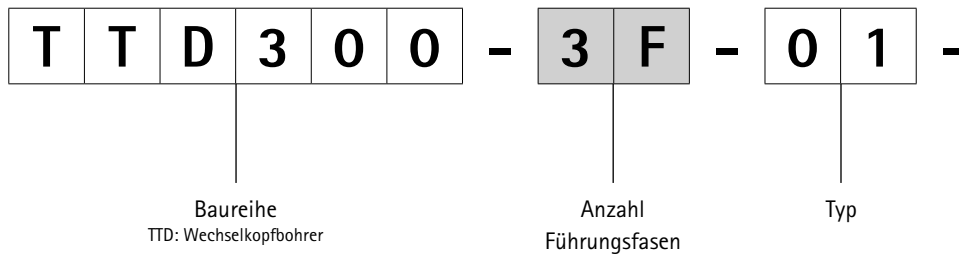

Halterprogramm TTS für TTD-Tritan

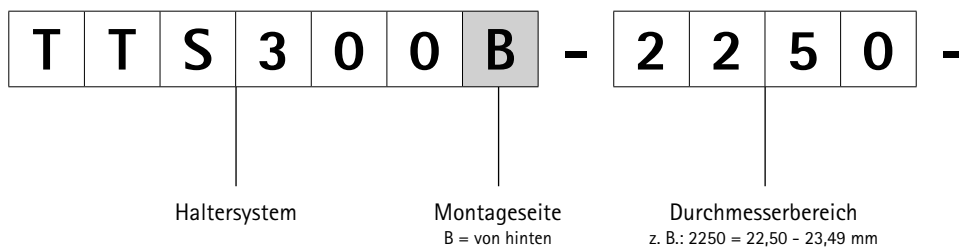

Halterprogramm QTS für QTD

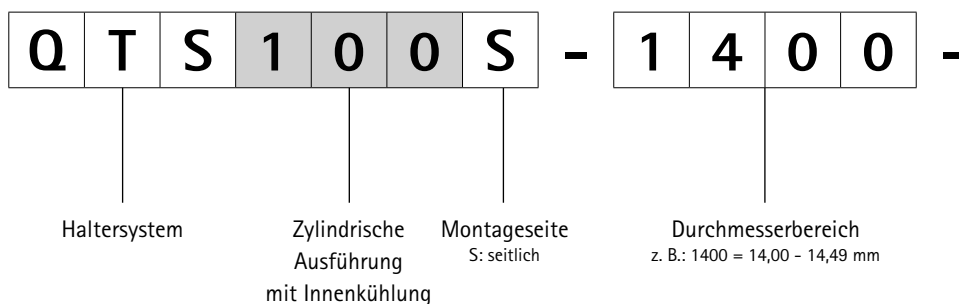

Halterprogramm TTS für TTD

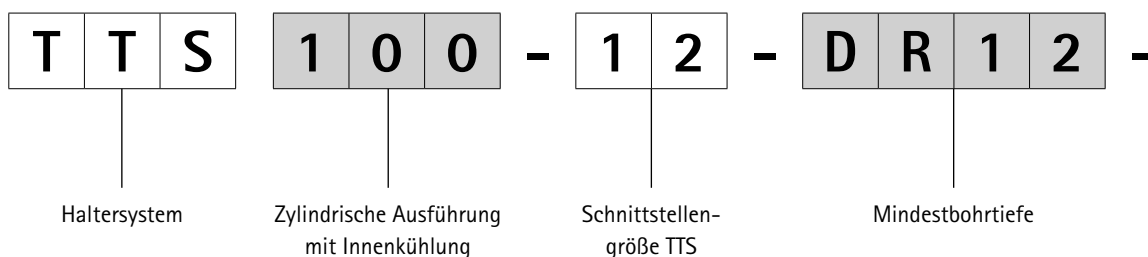

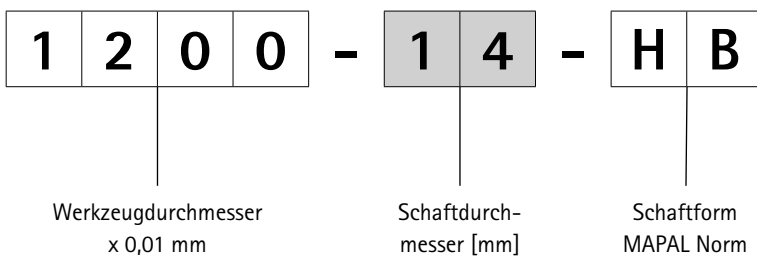
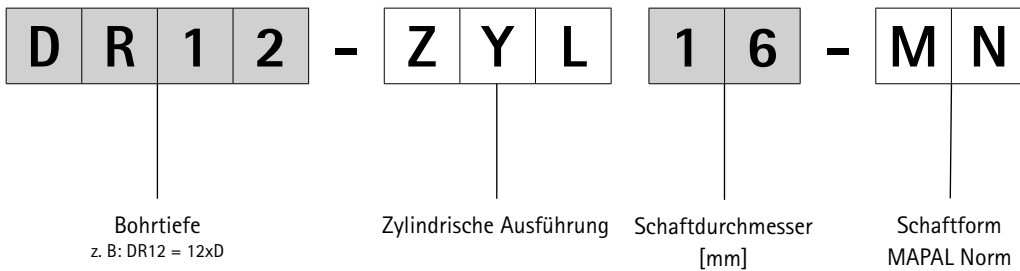
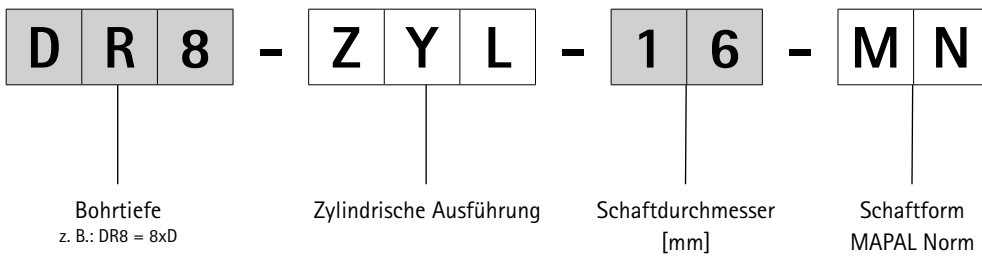
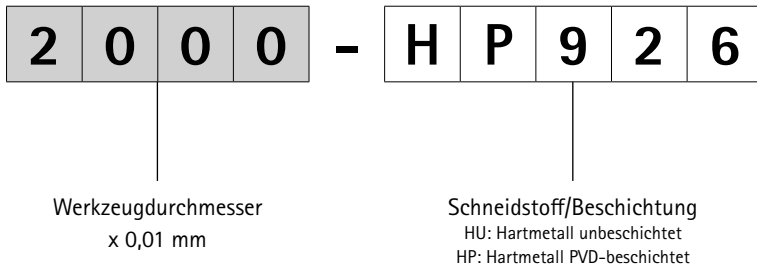



VOLLBOHREN MIT VOLLHARTMETALL

Universeller Einsatz

Tritan-Drill-Uni-Plus	30
MEGA-Speed-Drill-Uni	36
ECU-Drill-Uni	42

Stahl und gehärteter Stahl

MEGA-Drill-Steel-Plus	51
MEGA-Quadro-Drill-Plus	70
MICRO-Drill-Steel	79
MEGA-Drill-Hardened	82
Tritan-Drill-Steel	85
MEGA-Speed-Drill-Steel	95
MEGA-180°-Drill	105
ECU-Drill-Steel	111

Inox und Gusseisen

MEGA-Drill-Inox	129
MEGA-Speed-Drill-Inox	142
MEGA-Speed-Drill-Iron	150

Aluminium und Verbundwerkstoffe

MEGA-Drill-Alu	151
MEGA-Drill-Composite-MD	156
MEGA-Drill-Composite-UDX	158
MEGA-180°-Drill-Alu	160
ECU-G-Drill	164

Technischer Anhang

Schnittwertempfehlung	166
-----------------------------	-----



Tritan-Drill-Uni-Plus

Vollhartmetall-Spiralbohrer

SCD631 (5xD), innere Kühlmittelzufuhr, Nachfolgeprodukt des Tritan-Drill-Uni (SCD44)

Ausführung:

Bohrerdurchmesser: 4,00 – 20,00 mm
 Bohrungstoleranz: IT 9 (erreichbar)
 Schneidstoff: HP358
 Schneidanzahl: 3
 Anzahl Führungsfasen: 3
 Spitzenwinkel: 140°
 Spiralwinkel: 30°

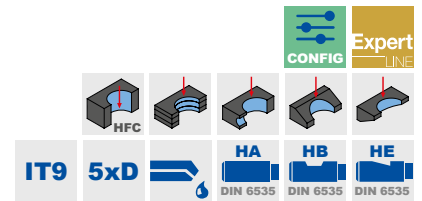
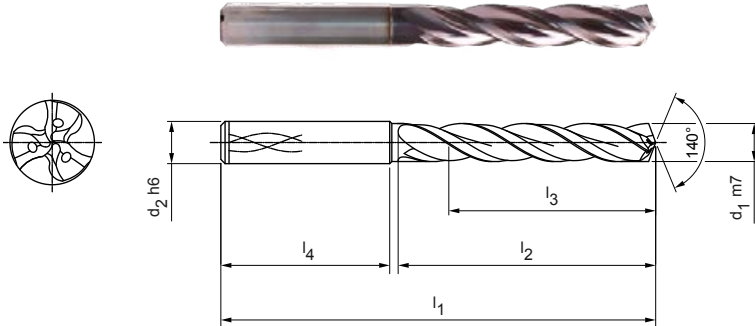

Lagerhaltige Vorzugsbaureihe in Schaftform HA

Baumaße						Schaftform HA	
d ₁ m7	d ₂ h6	l ₁	l ₂	l ₃	l ₄	Spezifikation	Bestell-Nr.
4,00	6	74	36	29	36	SCD631-0400-3-3-140HA05-HP358	31037282
4,10	6	74	36	29	36	SCD631-0410-3-3-140HA05-HP358	31037283
4,20	6	74	36	29	36	SCD631-0420-3-3-140HA05-HP358	31037284
4,30	6	74	36	29	36	SCD631-0430-3-3-140HA05-HP358	31037285
4,50	6	74	36	29	36	SCD631-0450-3-3-140HA05-HP358	31037287
4,80	6	82	44	35	36	SCD631-0480-3-3-140HA05-HP358	31037290
5,00	6	82	44	35	36	SCD631-0500-3-3-140HA05-HP358	31037292
5,10	6	82	44	35	36	SCD631-0510-3-3-140HA05-HP358	31037293
5,20	6	82	44	35	36	SCD631-0520-3-3-140HA05-HP358	31037294
5,30	6	82	44	35	36	SCD631-0530-3-3-140HA05-HP358	31037295
5,50	6	82	44	35	36	SCD631-0550-3-3-140HA05-HP358	31037297
5,55	6	82	44	35	36	SCD631-0555-3-3-140HA05-HP358	31307521
5,60	6	82	44	35	36	SCD631-0560-3-3-140HA05-HP358	31037298
5,70	6	82	44	35	36	SCD631-0570-3-3-140HA05-HP358	31037299
5,80	6	82	44	35	36	SCD631-0580-3-3-140HA05-HP358	31037300
5,90	6	82	44	35	36	SCD631-0590-3-3-140HA05-HP358	31037301
6,00	6	82	44	35	36	SCD631-0600-3-3-140HA05-HP358	31037302
6,10	8	91	53	43	36	SCD631-0610-3-3-140HA05-HP358	31037303
6,20	8	91	53	43	36	SCD631-0620-3-3-140HA05-HP358	31037304
6,30	8	91	53	43	36	SCD631-0630-3-3-140HA05-HP358	31037305
6,40	8	91	53	43	36	SCD631-0640-3-3-140HA05-HP358	31037306
6,50	8	91	53	43	36	SCD631-0650-3-3-140HA05-HP358	31037307
6,70	8	91	53	43	36	SCD631-0670-3-3-140HA05-HP358	31037309
6,80	8	91	53	43	36	SCD631-0680-3-3-140HA05-HP358	31037310
6,90	8	91	53	43	36	SCD631-0690-3-3-140HA05-HP358	31037311
7,00	8	91	53	43	36	SCD631-0700-3-3-140HA05-HP358	31037312
7,40	8	91	53	43	36	SCD631-0740-3-3-140HA05-HP358	31037316
7,50	8	91	53	43	36	SCD631-0750-3-3-140HA05-HP358	31037317
7,70	8	91	53	43	36	SCD631-0770-3-3-140HA05-HP358	31037319
7,80	8	91	53	43	36	SCD631-0780-3-3-140HA05-HP358	31037320
7,90	8	91	53	43	36	SCD631-0790-3-3-140HA05-HP358	31037321
8,00	8	91	53	43	36	SCD631-0800-3-3-140HA05-HP358	31037322
8,10	10	103	61	49	40	SCD631-0810-3-3-140HA05-HP358	31037323
8,50	10	103	61	49	40	SCD631-0850-3-3-140HA05-HP358	31037327
8,60	10	103	61	49	40	SCD631-0860-3-3-140HA05-HP358	31037328

Tritan-Drill-Uni-Plus | Vollhartmetall-Spiralbohrer SCD631 (5xD), innere Kühlmittelzufuhr

Baumaße						Schaftform HA	
d ₁ m7	d ₂ h6	l ₁	l ₂	l ₃	l ₄	Spezifikation	Bestell-Nr.
8,80	10	103	61	49	40	SCD631-0880-3-3-140HA05-HP358	31037330
9,00	10	103	61	49	40	SCD631-0900-3-3-140HA05-HP358	31037332
9,30	10	103	61	49	40	SCD631-0930-3-3-140HA05-HP358	31037335
9,50	10	103	61	49	40	SCD631-0950-3-3-140HA05-HP358	31037337
9,80	10	103	61	49	40	SCD631-0980-3-3-140HA05-HP358	31037340
9,90	10	103	61	49	40	SCD631-0990-3-3-140HA05-HP358	31037341
10,00	10	103	61	49	40	SCD631-1000-3-3-140HA05-HP358	31037342
10,20	12	118	71	56	45	SCD631-1020-3-3-140HA05-HP358	31037344
10,50	12	118	71	56	45	SCD631-1050-3-3-140HA05-HP358	31037347
11,00	12	118	71	56	45	SCD631-1100-3-3-140HA05-HP358	31037352
11,20	12	118	71	56	45	SCD631-1120-3-3-140HA05-HP358	31037354
11,50	12	118	71	56	45	SCD631-1150-3-3-140HA05-HP358	31037357
11,70	12	118	71	56	45	SCD631-1170-3-3-140HA05-HP358	31037359
11,80	12	118	71	56	45	SCD631-1180-3-3-140HA05-HP358	31037360
12,00	12	118	71	56	45	SCD631-1200-3-3-140HA05-HP358	31037362
12,50	14	124	77	60	45	SCD631-1250-3-3-140HA05-HP358	31037364
13,00	14	124	77	60	45	SCD631-1300-3-3-140HA05-HP358	31037366
13,50	14	124	77	60	45	SCD631-1350-3-3-140HA05-HP358	31037368
13,80	14	124	77	60	45	SCD631-1380-3-3-140HA05-HP358	31037369
14,00	14	124	77	60	45	SCD631-1400-3-3-140HA05-HP358	31037370
14,50	16	133	83	63	48	SCD631-1450-3-3-140HA05-HP358	31037372
14,80	16	133	83	63	48	SCD631-1480-3-3-140HA05-HP358	31037373
15,00	16	133	83	63	48	SCD631-1500-3-3-140HA05-HP358	31037374
15,50	16	133	83	63	48	SCD631-1550-3-3-140HA05-HP358	31037376
16,00	16	133	83	63	48	SCD631-1600-3-3-140HA05-HP358	31037378
17,00	18	143	93	71	48	SCD631-1700-3-3-140HA05-HP358	31037382
17,50	18	143	93	71	48	SCD631-1750-3-3-140HA05-HP358	31037384
18,00	18	143	93	71	48	SCD631-1800-3-3-140HA05-HP358	31037386
18,50	20	153	101	77	50	SCD631-1850-3-3-140HA05-HP358	31037388
19,80	20	153	101	77	50	SCD631-1980-3-3-140HA05-HP358	31037393
20,00	20	153	101	77	50	SCD631-2000-3-3-140HA05-HP358	31037394

Konfigurierbare Merkmale



Durchmesser:
Durchmesser in Abstufungen
von 0,01 mm frei wählbar



Schaftform:
Schaftform: HB | HE

Spezifikation:

SCD631-[Durchmesser]-3-3-140[Schaftform]05-HP358

Abmessungen konfigurierbare Baureihe

d ₁ min.	d ₁ max.	d ₂ h6	l ₁	l ₂	l ₃	l ₄
4,00	4,70	6	74	36	29	36
4,71	6,00	6	82	44	35	36
6,01	8,00	8	91	53	43	36
8,01	10,00	10	103	61	49	40
10,01	12,00	12	118	71	56	45
12,01	14,00	14	124	77	60	45
14,01	16,00	16	133	83	63	48
16,01	18,00	18	143	93	71	48
18,01	20,00	20	153	101	77	50

Beispiel:

SCD631-0431-3-3-140HE05-HP358

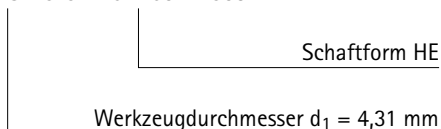

Maßangaben in mm.

Schnittwertempfehlung siehe Kapitelende.

Sonderausführungen und andere Beschichtungen auf Anfrage.

Tritan-Drill-Uni-Plus

Vollhartmetall-Spiralbohrer

SCD631 (8xD), innere Kühlmittelzufuhr, Nachfolgeprodukt des Tritan-Drill-Uni (SCD44)

Ausführung:

Bohrerdurchmesser: 4,00 – 20,00 mm
 Bohrungstoleranz: IT 9 (erreichbar)
 Schneidstoff: HP358
 Schneidanzahl: 3
 Anzahl Führungsfasen: 3
 Spitzenwinkel: 135°
 Spiralwinkel: 30°

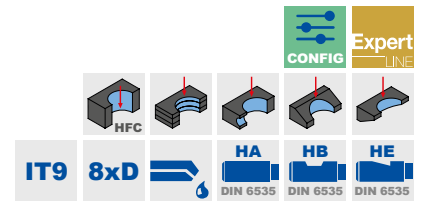
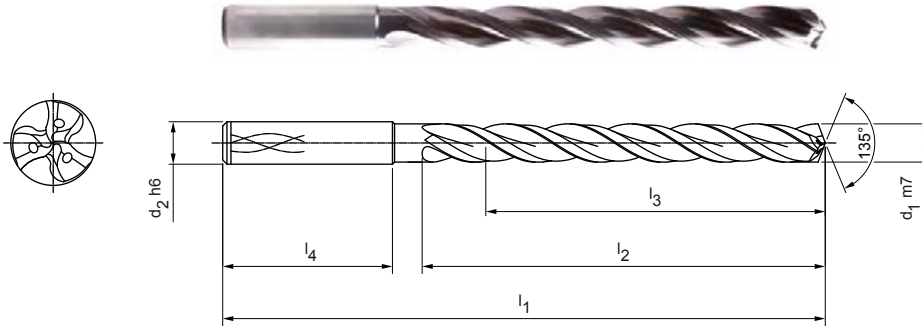

Lagerhaltige Vorzugsbaureihe in Schaftform HA

Baumaße						Schaftform HA	
d ₁ m7	d ₂ h6	l ₁	l ₂	l ₃	l ₄	Spezifikation	Bestell-Nr.
4,00	6	81	43	36	36	SCD631-0400-3-3-135HA08-HP358	31037395
4,10	6	81	43	36	36	SCD631-0410-3-3-135HA08-HP358	31037396
4,30	6	81	43	36	36	SCD631-0430-3-3-135HA08-HP358	31037398
4,50	6	81	43	36	36	SCD631-0450-3-3-135HA08-HP358	31037400
4,60	6	81	43	36	36	SCD631-0460-3-3-135HA08-HP358	31037401
4,70	6	81	43	36	36	SCD631-0470-3-3-135HA08-HP358	31037402
4,90	6	95	57	48	36	SCD631-0490-3-3-135HA08-HP358	31037404
5,00	6	95	57	48	36	SCD631-0500-3-3-135HA08-HP358	31037405
5,03	6	95	57	48	36	SCD631-0503-3-3-135HA08-HP358	31266415
5,10	6	95	57	48	36	SCD631-0510-3-3-135HA08-HP358	31037406
5,20	6	95	57	48	36	SCD631-0520-3-3-135HA08-HP358	31037407
5,50	6	95	57	48	36	SCD631-0550-3-3-135HA08-HP358	31037410
5,60	6	95	57	48	36	SCD631-0560-3-3-135HA08-HP358	31037411
5,80	6	95	57	48	36	SCD631-0580-3-3-135HA08-HP358	31037413
6,00	6	95	57	48	36	SCD631-0600-3-3-135HA08-HP358	31037415
6,10	8	114	76	64	36	SCD631-0610-3-3-135HA08-HP358	31037416
6,50	8	114	76	64	36	SCD631-0650-3-3-135HA08-HP358	31037420
6,80	8	114	76	64	36	SCD631-0680-3-3-135HA08-HP358	31037423
6,90	8	114	76	64	36	SCD631-0690-3-3-135HA08-HP358	31037424
7,00	8	114	76	64	36	SCD631-0700-3-3-135HA08-HP358	31037425
7,10	8	114	76	64	36	SCD631-0710-3-3-135HA08-HP358	31037426
7,50	8	114	76	64	36	SCD631-0750-3-3-135HA08-HP358	31037430
7,80	8	114	76	64	36	SCD631-0780-3-3-135HA08-HP358	31037433
7,90	8	114	76	64	36	SCD631-0790-3-3-135HA08-HP358	31037434
8,00	8	114	76	64	36	SCD631-0800-3-3-135HA08-HP358	31037435
8,50	10	142	95	80	40	SCD631-0850-3-3-135HA08-HP358	31037440
8,80	10	142	95	80	40	SCD631-0880-3-3-135HA08-HP358	31037443
9,00	10	142	95	80	40	SCD631-0900-3-3-135HA08-HP358	31037445
9,10	10	142	95	80	40	SCD631-0910-3-3-135HA08-HP358	31037446
9,40	10	142	95	80	40	SCD631-0940-3-3-135HA08-HP358	31037449
9,50	10	142	95	80	40	SCD631-0950-3-3-135HA08-HP358	31037450
9,80	10	142	95	80	40	SCD631-0980-3-3-135HA08-HP358	31037453
10,00	10	142	95	80	40	SCD631-1000-3-3-135HA08-HP358	31037455
11,00	12	162	114	96	45	SCD631-1100-3-3-135HA08-HP358	31037465
11,80	12	162	114	96	45	SCD631-1180-3-3-135HA08-HP358	31037473

Tritan-Drill-Uni-Plus | Vollhartmetall-Spiralbohrer SCD631 (8xD), innere Kühlmittelzufuhr

Baumaße						Schaftform HA	
d ₁ m7	d ₂ h6	l ₁	l ₂	l ₃	l ₄	Spezifikation	Bestell-Nr.
12,00	12	162	114	96	45	SCD631-1200-3-3-135HA08-HP358	31037475
12,50	14	178	133	112	45	SCD631-1250-3-3-135HA08-HP358	31037477
13,00	14	178	133	112	45	SCD631-1300-3-3-135HA08-HP358	31037479
13,50	14	178	133	112	45	SCD631-1350-3-3-135HA08-HP358	31037481
14,00	14	178	133	112	45	SCD631-1400-3-3-135HA08-HP358	31037483
15,00	16	203	152	128	48	SCD631-1500-3-3-135HA08-HP358	31037487
16,00	16	203	152	128	48	SCD631-1600-3-3-135HA08-HP358	31037491
17,00	18	222	171	144	48	SCD631-1700-3-3-135HA08-HP358	31037495

Konfigurierbare Merkmale

**Durchmesser:**

Durchmesser in Abstufungen
von 0,01 mm frei wählbar

**Schaftform:**

Schaftform: HB | HE

Spezifikation:

SCD631-[Durchmesser]-3-3-140[Schaftform]08-HP358

Abmessungen konfigurierbare Baureihe

d ₁ min.	d ₁ max.	d ₂ h6	l ₁	l ₂	l ₃	l ₄
4,00	4,70	6	81	43	36	36
4,71	6,00	6	95	57	48	36
6,01	8,00	8	114	76	64	36
8,01	10,00	10	142	95	80	40
10,01	12,00	12	162	114	96	45
12,01	14,00	14	178	133	112	45
14,01	16,00	16	203	152	128	48
16,01	18,00	18	222	171	144	48
18,01	20,00	20	243	190	160	50

Beispiel:

SCD631-0431-3-3-140HE08-HP358

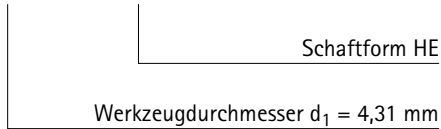

Maßangaben in mm.

Schnittwertempfehlung siehe Kapitelende.

Sonderausführungen und andere Beschichtungen auf Anfrage.

Tritan-Drill-Uni-Plus

Vollhartmetall-Spiralbohrer

SCD631 (12xD), innere Kühlmittelzufuhr, Nachfolgeprodukt des Tritan-Drill-Uni (SCD44)

Ausführung:

Bohrerdurchmesser: 4,00 – 20,00 mm
 Bohrungstoleranz: IT 9 (erreichbar)
 Schneidstoff: HP358
 Schneidanzahl: 3
 Anzahl Führungsfasen: 3
 Spitzenwinkel: 135°
 Spiralwinkel: 30°

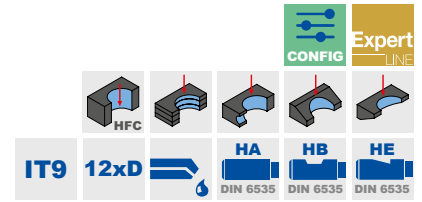
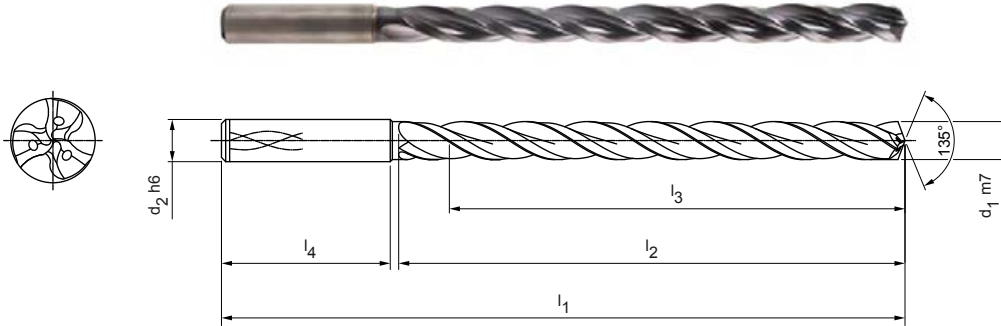

Lagerhaltige Vorzugsbaureihe in Schaftform HA

Baumaße						Schaftform HA	
d ₁ m7	d ₂ h6	l ₁	l ₂	l ₃	l ₄	Spezifikation	Bestell-Nr.
4,00	6	102	64	58	36	SCD631-0400-3-3-135HA12-HP358	31035357
4,10	6	102	64	58	36	SCD631-0410-3-3-135HA12-HP358	31035358
4,20	6	102	64	58	36	SCD631-0420-3-3-135HA12-HP358	31035359
4,30	6	102	64	58	36	SCD631-0430-3-3-135HA12-HP358	31035360
4,50	6	102	64	58	36	SCD631-0450-3-3-135HA12-HP358	31035362
4,60	6	102	64	58	36	SCD631-0460-3-3-135HA12-HP358	31035363
4,70	6	102	64	58	36	SCD631-0470-3-3-135HA12-HP358	31035364
4,80	6	116	78	70	36	SCD631-0480-3-3-135HA12-HP358	31035365
5,00	6	116	78	70	36	SCD631-0500-3-3-135HA12-HP358	31035367
5,10	6	116	78	70	36	SCD631-0510-3-3-135HA12-HP358	31035368
5,20	6	116	78	70	36	SCD631-0520-3-3-135HA12-HP358	31035369
5,40	6	116	78	70	36	SCD631-0540-3-3-135HA12-HP358	31035371
5,50	6	116	78	70	36	SCD631-0550-3-3-135HA12-HP358	31035372
5,80	6	116	78	70	36	SCD631-0580-3-3-135HA12-HP358	31035375
6,00	6	116	78	70	36	SCD631-0600-3-3-135HA12-HP358	31035377
6,10	8	146	108	94	36	SCD631-0610-3-3-135HA12-HP358	31035378
6,20	8	146	108	94	36	SCD631-0620-3-3-135HA12-HP358	31035379
6,50	8	146	108	94	36	SCD631-0650-3-3-135HA12-HP358	31035382
6,60	8	146	108	94	36	SCD631-0660-3-3-135HA12-HP358	31035383
6,80	8	146	108	94	36	SCD631-0680-3-3-135HA12-HP358	31035385
7,00	8	146	108	94	36	SCD631-0700-3-3-135HA12-HP358	31035387
7,50	8	146	108	94	36	SCD631-0750-3-3-135HA12-HP358	31035392
7,80	8	146	108	94	36	SCD631-0780-3-3-135HA12-HP358	31035395
8,00	8	146	108	94	36	SCD631-0800-3-3-135HA12-HP358	31035397
8,50	10	162	120	110	40	SCD631-0850-3-3-135HA12-HP358	31035402
9,00	10	162	120	110	40	SCD631-0900-3-3-135HA12-HP358	31035407
9,50	10	162	120	110	40	SCD631-0950-3-3-135HA12-HP358	31035412
9,80	10	162	120	110	40	SCD631-0980-3-3-135HA12-HP358	31035415
9,90	10	162	120	110	40	SCD631-0990-3-3-135HA12-HP358	31035416
10,00	10	162	120	110	40	SCD631-1000-3-3-135HA12-HP358	31035417
10,20	12	204	156	142	45	SCD631-1020-3-3-135HA12-HP358	31035419
10,50	12	204	156	142	45	SCD631-1050-3-3-135HA12-HP358	31035422
11,00	12	204	156	142	45	SCD631-1100-3-3-135HA12-HP358	31035427
11,30	12	204	156	142	45	SCD631-1130-3-3-135HA12-HP358	31035430
11,80	12	204	156	142	45	SCD631-1180-3-3-135HA12-HP358	31035435

Tritan-Drill-Uni-Plus | Vollhartmetall-Spiralbohrer SCD631 (12xD), innere Kühlmittelzufuhr

Baumaße						Schaftform HA	
d ₁ m7	d ₂ h6	l ₁	l ₂	l ₃	l ₄	Spezifikation	Bestell-Nr.
12,00	12	204	156	142	45	SCD631-1200-3-3-135HA12-HP358	31035437
12,50	14	230	182	166	45	SCD631-1250-3-3-135HA12-HP358	31035439
13,00	14	230	182	166	45	SCD631-1300-3-3-135HA12-HP358	31035441
13,50	14	230	182	166	45	SCD631-1350-3-3-135HA12-HP358	31035443
13,80	14	230	182	166	45	SCD631-1380-3-3-135HA12-HP358	31035444
14,00	14	230	182	166	45	SCD631-1400-3-3-135HA12-HP358	31035445
15,00	16	260	208	192	48	SCD631-1500-3-3-135HA12-HP358	31035449
15,80	16	260	208	192	48	SCD631-1580-3-3-135HA12-HP358	31035452
16,00	16	260	208	192	48	SCD631-1600-3-3-135HA12-HP358	31035453

Konfigurierbare Merkmale

Durchmesser:
Durchmesser in Abstufungen von 0,01 mm frei wählbar

Schaftform:
Schaftform: HB | HE

Spezifikation:
SCD631-[Durchmesser]-3-3-140[Schaftform]12-HP358

Abmessungen konfigurierbare Baureihe

d ₁ min.	d ₁ max.	d ₂ h6	l ₁	l ₂	l ₃	l ₄
4,00	4,70	6	102	64	58	36
4,71	6,00	6	116	78	70	36
6,01	8,00	8	146	108	94	36
8,01	10,00	10	162	120	110	40
10,01	12,00	12	204	156	142	45
12,01	14,00	14	230	182	166	45
14,01	16,00	16	260	208	192	48
16,01	18,00	18	285	234	216	48
18,01	20,00	20	310	258	240	50

Beispiel:
SCD631-0431-3-3-140HE12-HP358

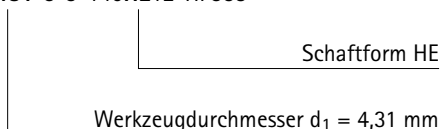

Maßangaben in mm.
Schnittwertempfehlung siehe Kapitelende.
Sonderausführungen und andere Beschichtungen auf Anfrage.

MEGA-Speed-Drill-Uni

Vollhartmetall-Spiralbohrer
SCD221 (3xD), innere Kühlmittelzufuhr

Ausführung:
Bohrerdurchmesser: 3,00 – 20,00 mm
Bohrungstoleranz: ≥ IT 9
Schneidstoff: HP374
Schneidenanzahl: 2
Anzahl Führungsfasen: 3
Spitzenwinkel: 135°
Spiralwinkel: 30°

Anwendung:
Für Hochgeschwindigkeitsbearbeitung.

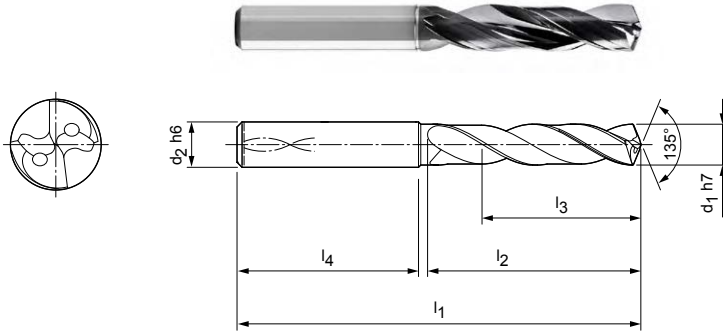

Lagerhaltige Vorzugsbaureihe in Schaftform HA

Baumaße						Schaftform HA	
d ₁ h7	d ₂ h6	l ₁	l ₂	l ₃	l ₄	Spezifikation	Bestell-Nr.
3,00	6	62	20	14	36	SCD221-0300-2-3-135HA03-HP374	30404127
3,10	6	62	20	14	36	SCD221-0310-2-3-135HA03-HP374	30404128
3,20	6	62	20	14	36	SCD221-0320-2-3-135HA03-HP374	30404129
3,30	6	62	20	14	36	SCD221-0330-2-3-135HA03-HP374	30404130
3,40	6	62	20	14	36	SCD221-0340-2-3-135HA03-HP374	30404131
3,50	6	62	20	14	36	SCD221-0350-2-3-135HA03-HP374	30404132
3,70	6	62	20	14	36	SCD221-0370-2-3-135HA03-HP374	30404134
4,00	6	66	24	17	36	SCD221-0400-2-3-135HA03-HP374	30404137
4,20	6	66	24	17	36	SCD221-0420-2-3-135HA03-HP374	30404139
4,30	6	66	24	17	36	SCD221-0430-2-3-135HA03-HP374	30404140
4,50	6	66	24	17	36	SCD221-0450-2-3-135HA03-HP374	30404142
5,00	6	66	28	20	36	SCD221-0500-2-3-135HA03-HP374	30404148
5,10	6	66	28	20	36	SCD221-0510-2-3-135HA03-HP374	30404149
5,20	6	66	28	20	36	SCD221-0520-2-3-135HA03-HP374	30404150
5,50	6	66	28	20	36	SCD221-0550-2-3-135HA03-HP374	30404153
5,55	6	66	28	20	36	SCD221-0555-2-3-135HA03-HP374	30404154
5,60	6	66	28	20	36	SCD221-0560-2-3-135HA03-HP374	30404155
5,80	6	66	28	20	36	SCD221-0580-2-3-135HA03-HP374	30404157
6,00	6	66	28	20	36	SCD221-0600-2-3-135HA03-HP374	30404159
6,30	8	79	34	24	36	SCD221-0630-2-3-135HA03-HP374	30404162
6,50	8	79	34	24	36	SCD221-0650-2-3-135HA03-HP374	30404164
6,80	8	79	34	24	36	SCD221-0680-2-3-135HA03-HP374	30404167
6,90	8	79	34	24	36	SCD221-0690-2-3-135HA03-HP374	30404168
7,00	8	79	34	24	36	SCD221-0700-2-3-135HA03-HP374	30404169
7,40	8	79	41	29	36	SCD221-0740-2-3-135HA03-HP374	30404173
7,50	8	79	41	29	36	SCD221-0750-2-3-135HA03-HP374	30404175
7,80	8	79	41	29	36	SCD221-0780-2-3-135HA03-HP374	30404178
8,00	8	79	41	29	36	SCD221-0800-2-3-135HA03-HP374	30404180
8,50	10	89	47	35	40	SCD221-0850-2-3-135HA03-HP374	30404185
8,60	10	89	47	35	40	SCD221-0860-2-3-135HA03-HP374	30404186
8,80	10	89	47	35	40	SCD221-0880-2-3-135HA03-HP374	30404188
9,00	10	89	47	35	40	SCD221-0900-2-3-135HA03-HP374	30404190
9,50	10	89	47	35	40	SCD221-0950-2-3-135HA03-HP374	30404195
9,80	10	89	47	35	40	SCD221-0980-2-3-135HA03-HP374	30404198
9,90	10	89	47	35	40	SCD221-0990-2-3-135HA03-HP374	30404199

MEGA-Speed-Drill-Uni | Vollhartmetall-Spiralbohrer SCD221 (3xD), innere Kühlmittelzufuhr

Baumaße						Schaftform HA	
d ₁ h7	d ₂ h6	l ₁	l ₂	l ₃	l ₄	Spezifikation	Bestell-Nr.
10,00	10	89	47	35	40	SCD221-1000-2-3-135HA03-HP374	30404200
10,20	12	102	55	40	45	SCD221-1020-2-3-135HA03-HP374	30404202
10,30	12	102	55	40	45	SCD221-1030-2-3-135HA03-HP374	30404203
10,50	12	102	55	40	45	SCD221-1050-2-3-135HA03-HP374	30404205
10,60	12	102	55	40	45	SCD221-1060-2-3-135HA03-HP374	30404206
11,00	12	102	55	40	45	SCD221-1100-2-3-135HA03-HP374	30404210
11,50	12	102	55	40	45	SCD221-1150-2-3-135HA03-HP374	30404215
11,60	12	102	55	40	45	SCD221-1160-2-3-135HA03-HP374	30404216
11,80	12	102	55	40	45	SCD221-1180-2-3-135HA03-HP374	30404219
12,00	12	102	55	40	45	SCD221-1200-2-3-135HA03-HP374	30404221
12,50	14	107	60	43	45	SCD221-1250-2-3-135HA03-HP374	30404222
13,00	14	107	60	43	45	SCD221-1300-2-3-135HA03-HP374	30404224
13,50	14	107	60	43	45	SCD221-1350-2-3-135HA03-HP374	30404225
14,00	14	107	60	43	45	SCD221-1400-2-3-135HA03-HP374	30404227
14,50	16	115	65	45	48	SCD221-1450-2-3-135HA03-HP374	30404228
15,00	16	115	65	45	48	SCD221-1500-2-3-135HA03-HP374	30404230
16,00	16	115	65	45	48	SCD221-1600-2-3-135HA03-HP374	30404233
17,00	18	123	73	51	48	SCD221-1700-2-3-135HA03-HP374	30404236
17,50	18	123	73	51	48	SCD221-1750-2-3-135HA03-HP374	30404237
17,80	18	123	73	51	48	SCD221-1780-2-3-135HA03-HP374	30404238
18,00	18	123	73	51	48	SCD221-1800-2-3-135HA03-HP374	30404239
18,50	20	131	79	55	50	SCD221-1850-2-3-135HA03-HP374	30404240
19,50	20	131	79	55	50	SCD221-1950-2-3-135HA03-HP374	30404243
20,00	20	131	79	55	50	SCD221-2000-2-3-135HA03-HP374	30404245

Konfigurierbare Merkmale



Durchmesser:
Durchmesser in Abstufungen
von 0,01 mm frei wählbar



Schaftform:
Schaftform: HB | HE

Spezifikation:

SCD221-[Durchmesser]-3-3-140[Schaftform]03-HP358

Abmessungen konfigurierbare Baureihe

d ₁ min.	d ₁ max.	d ₂ h6	l ₁	l ₂	l ₃	l ₄
3,00	3,70	6	62	20	14	36
3,71	4,70	6	66	24	17	36
4,71	6,00	6	66	28	20	36
6,01	8,00	8	79	34	24	36
8,01	10,00	10	89	47	35	40
10,01	12,00	12	102	55	40	45
12,01	14,00	14	107	60	43	45
14,01	16,00	16	115	65	45	48
16,01	18,00	18	123	73	51	48
18,01	20,00	20	131	79	55	50

Beispiel:

SCD221-0431-3-3-140HE03-HP358

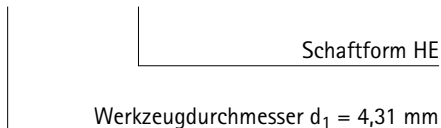

Maßangaben in mm.

Schnittwertempfehlung siehe Kapitelende.

Sonderausführungen und andere Beschichtungen auf Anfrage.

MEGA-Speed-Drill-Uni

Vollhartmetall-Spiralbohrer
SCD221 (5xD), innere Kühlmittelzufuhr

Ausführung:
Bohrerdurchmesser: 3,00 – 20,00 mm
Bohrungstoleranz: ≥ IT 9
Schneidstoff: HP374
Schneidenanzahl: 2
Anzahl Führungsfasen: 3
Spitzenwinkel: 135°
Spiralwinkel: 30°

Anwendung:
Für Hochgeschwindigkeitsbearbeitung.

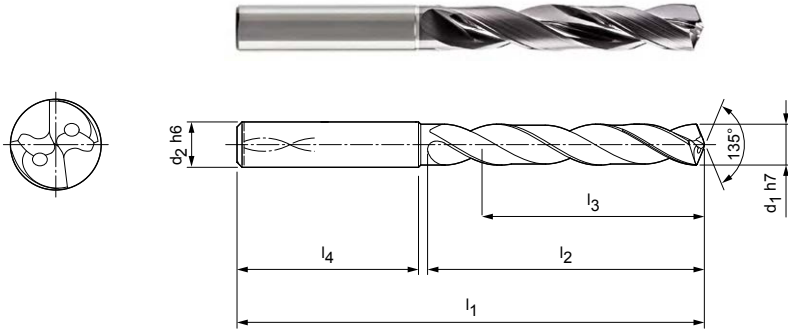

Lagerhaltige Vorzugsbaureihe in Schaftform HA

Baumaße						Schaftform HA	
d ₁ h7	d ₂ h6	l ₁	l ₂	l ₃	l ₄	Spezifikation	Bestell-Nr.
3,00	6	66	28	23	36	SCD221-0300-2-3-135HA05-HP374	30392925
3,10	6	66	28	23	36	SCD221-0310-2-3-135HA05-HP374	30392926
3,20	6	66	28	23	36	SCD221-0320-2-3-135HA05-HP374	30392927
3,30	6	66	28	23	36	SCD221-0330-2-3-135HA05-HP374	30392928
3,40	6	66	28	23	36	SCD221-0340-2-3-135HA05-HP374	30392929
3,50	6	66	28	23	36	SCD221-0350-2-3-135HA05-HP374	30392930
3,70	6	66	28	23	36	SCD221-0370-2-3-135HA05-HP374	30392932
4,00	6	74	36	29	36	SCD221-0400-2-3-135HA05-HP374	30392935
4,20	6	74	36	29	36	SCD221-0420-2-3-135HA05-HP374	30392937
4,30	6	74	36	29	36	SCD221-0430-2-3-135HA05-HP374	30392938
4,50	6	74	36	29	36	SCD221-0450-2-3-135HA05-HP374	30392940
5,00	6	82	44	35	36	SCD221-0500-2-3-135HA05-HP374	30392946
5,10	6	82	44	35	36	SCD221-0510-2-3-135HA05-HP374	30392947
5,20	6	82	44	35	36	SCD221-0520-2-3-135HA05-HP374	30392948
5,50	6	82	44	35	36	SCD221-0550-2-3-135HA05-HP374	30392951
5,60	6	82	44	35	36	SCD221-0560-2-3-135HA05-HP374	30392953
5,80	6	82	44	35	36	SCD221-0580-2-3-135HA05-HP374	30392955
6,00	6	82	44	35	36	SCD221-0600-2-3-135HA05-HP374	30392957
6,50	8	91	53	43	36	SCD221-0650-2-3-135HA05-HP374	30392962
6,60	8	91	53	43	36	SCD221-0660-2-3-135HA05-HP374	30392963
6,80	8	91	53	43	36	SCD221-0680-2-3-135HA05-HP374	30392965
6,90	8	91	53	43	36	SCD221-0690-2-3-135HA05-HP374	30392966
7,00	8	91	53	43	36	SCD221-0700-2-3-135HA05-HP374	30392967
7,40	8	91	53	43	36	SCD221-0740-2-3-135HA05-HP374	30392971
7,50	8	91	53	43	36	SCD221-0750-2-3-135HA05-HP374	30392972
7,80	8	91	53	43	36	SCD221-0780-2-3-135HA05-HP374	30392975
8,00	8	91	53	43	36	SCD221-0800-2-3-135HA05-HP374	30392977
8,50	10	103	61	49	40	SCD221-0850-2-3-135HA05-HP374	30392982
8,60	10	103	61	49	40	SCD221-0860-2-3-135HA05-HP374	30392983
8,80	10	103	61	49	40	SCD221-0880-2-3-135HA05-HP374	30392985
9,00	10	103	61	49	40	SCD221-0900-2-3-135HA05-HP374	30392987
9,50	10	103	61	49	40	SCD221-0950-2-3-135HA05-HP374	30392992
9,70	10	103	61	49	40	SCD221-0970-2-3-135HA05-HP374	30392994
9,80	10	103	61	49	40	SCD221-0980-2-3-135HA05-HP374	30392995
10,00	10	103	61	49	40	SCD221-1000-2-3-135HA05-HP374	30392997

MEGA-Speed-Drill-Uni | Vollhartmetall-Spiralbohrer SCD221 (5xD), innere Kühlmittelzufuhr

Baumaße						Schaftform HA	
d ₁ h7	d ₂ h6	l ₁	l ₂	l ₃	l ₄	Spezifikation	Bestell-Nr.
10,20	12	118	71	56	45	SCD221-1020-2-3-135HA05-HP374	30392999
10,30	12	118	71	56	45	SCD221-1030-2-3-135HA05-HP374	30393000
10,50	12	118	71	56	45	SCD221-1050-2-3-135HA05-HP374	30393002
11,00	12	118	71	56	45	SCD221-1100-2-3-135HA05-HP374	30393007
11,50	12	118	71	56	45	SCD221-1150-2-3-135HA05-HP374	30393012
11,80	12	118	71	56	45	SCD221-1180-2-3-135HA05-HP374	30393015
12,00	12	118	71	56	45	SCD221-1200-2-3-135HA05-HP374	30393017
12,50	14	124	77	60	45	SCD221-1250-2-3-135HA05-HP374	30393018
13,00	14	124	77	60	45	SCD221-1300-2-3-135HA05-HP374	30393020
13,50	14	124	77	60	45	SCD221-1350-2-3-135HA05-HP374	30393021
13,80	14	124	77	60	45	SCD221-1380-2-3-135HA05-HP374	30393022
14,00	14	124	77	60	45	SCD221-1400-2-3-135HA05-HP374	30393023
14,50	16	133	83	63	48	SCD221-1450-2-3-135HA05-HP374	30393024
15,00	16	133	83	63	48	SCD221-1500-2-3-135HA05-HP374	30393026
15,50	16	133	83	63	48	SCD221-1550-2-3-135HA05-HP374	30393027
15,80	16	133	83	63	48	SCD221-1580-2-3-135HA05-HP374	30393028
16,00	16	133	83	63	48	SCD221-1600-2-3-135HA05-HP374	30393029
16,80	18	143	93	71	48	SCD221-1680-2-3-135HA05-HP374	30393031
17,00	18	143	93	71	48	SCD221-1700-2-3-135HA05-HP374	30393032
17,50	18	143	93	71	48	SCD221-1750-2-3-135HA05-HP374	30393033
17,80	18	143	93	71	48	SCD221-1780-2-3-135HA05-HP374	30393034
18,00	18	143	93	71	48	SCD221-1800-2-3-135HA05-HP374	30393035
18,50	20	153	101	77	50	SCD221-1850-2-3-135HA05-HP374	30393036
18,80	20	153	101	77	50	SCD221-1880-2-3-135HA05-HP374	30393037
19,00	20	153	101	77	50	SCD221-1900-2-3-135HA05-HP374	30393038
20,00	20	153	101	77	50	SCD221-2000-2-3-135HA05-HP374	30393041

Konfigurierbare Merkmale



Durchmesser:
Durchmesser in Abstufungen
von 0,01 mm frei wählbar



Schaftform:
Schaftform: HB | HE

Spezifikation:

SCD221-[Durchmesser]-3-3-140[Schaftform]05-HP358

Abmessungen konfigurierbare Baureihe

d ₁ min.	d ₁ max.	d ₂ h6	l ₁	l ₂	l ₃	l ₄
3,00	3,70	6	66	28	23	36
3,71	4,70	6	74		29	36
4,71	6,00	6	82	44	35	36
6,01	8,00	8	91	53	43	36
8,01	10,00	10	103	61	49	40
10,01	12,00	12	118	71	56	45
12,01	14,00	14	124	77	60	45
14,01	16,00	16	133	83	63	48
16,01	18,00	18	143	93	71	48
18,01	20,00	20	153	101	77	50

Beispiel:

SCD221-0431-3-3-140HE05-HP374

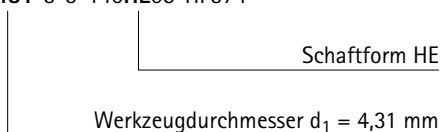

Maßangaben in mm.

Schnittwertempfehlung siehe Kapitelende.

Sonderausführungen und andere Beschichtungen auf Anfrage.

MEGA-Speed-Drill-Uni

Vollhartmetall-Spiralbohrer
SCD221 (8xD), innere Kühlmittelzufuhr

Ausführung:

Bohrerdurchmesser: 3,00 – 20,00 mm
Bohrungstoleranz: \geq IT 9
Schneidstoff: HP374
Schneidenanzahl: 2
Anzahl Führungsfasen: 3
Spitzenwinkel: 135°
Spiralwinkel: 30°

Anwendung:

Für Hochgeschwindigkeitsbearbeitung.

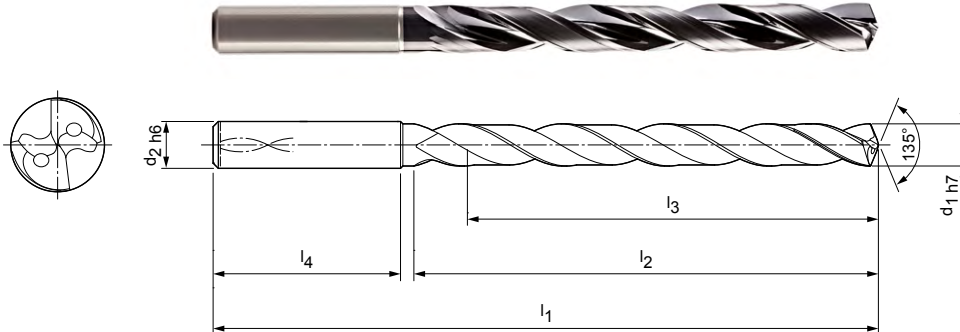

Lagerhaltige Vorzugsbaureihe in Schaftform HA

Baumaße						Schaftform HA	
d ₁ h7	d ₂ h6	l ₁	l ₂	l ₃	l ₄	Spezifikation	Bestell-Nr.
3,00	6	72	34	29	36	SCD221-0300-2-3-135HA08-HP374	30404000
3,20	6	72	34	29	36	SCD221-0320-2-3-135HA08-HP374	30404002
3,30	6	72	34	29	36	SCD221-0330-2-3-135HA08-HP374	30404003
3,40	6	72	34	29	36	SCD221-0340-2-3-135HA08-HP374	30404004
3,50	6	72	34	29	36	SCD221-0350-2-3-135HA08-HP374	30404005
3,70	6	72	34	29	36	SCD221-0370-2-3-135HA08-HP374	30404007
4,00	6	81	43	36	36	SCD221-0400-2-3-135HA08-HP374	30404010
4,10	6	81	43	36	36	SCD221-0410-2-3-135HA08-HP374	30404011
4,20	6	81	43	36	36	SCD221-0420-2-3-135HA08-HP374	30404012
4,30	6	81	43	36	36	SCD221-0430-2-3-135HA08-HP374	30404013
4,50	6	81	43	36	36	SCD221-0450-2-3-135HA08-HP374	30404015
4,80	6	95	57	48	36	SCD221-0480-2-3-135HA08-HP374	30404019
5,00	6	95	57	48	36	SCD221-0500-2-3-135HA08-HP374	30404021
5,10	6	95	57	48	36	SCD221-0510-2-3-135HA08-HP374	30404022
5,20	6	95	57	48	36	SCD221-0520-2-3-135HA08-HP374	30404023
5,40	6	95	57	48	36	SCD221-0540-2-3-135HA08-HP374	30404025
5,50	6	95	57	48	36	SCD221-0550-2-3-135HA08-HP374	30404026
5,80	6	95	57	48	36	SCD221-0580-2-3-135HA08-HP374	30404030
6,00	6	95	57	48	36	SCD221-0600-2-3-135HA08-HP374	30404032
6,10	8	114	76	64	36	SCD221-0610-2-3-135HA08-HP374	30404033
6,40	8	114	76	64	36	SCD221-0640-2-3-135HA08-HP374	30404036
6,50	8	114	76	64	36	SCD221-0650-2-3-135HA08-HP374	30404037
6,80	8	114	76	64	36	SCD221-0680-2-3-135HA08-HP374	30404040
7,00	8	114	76	64	36	SCD221-0700-2-3-135HA08-HP374	30404043
7,50	8	114	76	64	36	SCD221-0750-2-3-135HA08-HP374	30404048
7,80	8	114	76	64	36	SCD221-0780-2-3-135HA08-HP374	30404051
8,00	8	114	76	64	36	SCD221-0800-2-3-135HA08-HP374	30404053
8,50	10	142	95	80	40	SCD221-0850-2-3-135HA08-HP374	30404058
9,00	10	142	95	80	40	SCD221-0900-2-3-135HA08-HP374	30404063
9,30	10	142	95	80	40	SCD221-0930-2-3-135HA08-HP374	30404066
9,50	10	142	95	80	40	SCD221-0950-2-3-135HA08-HP374	30404068
9,60	10	142	95	80	40	SCD221-0960-2-3-135HA08-HP374	30404069
9,80	10	142	95	80	40	SCD221-0980-2-3-135HA08-HP374	30404071
10,00	10	142	95	80	40	SCD221-1000-2-3-135HA08-HP374	30404073
10,20	12	162	114	96	45	SCD221-1020-2-3-135HA08-HP374	30404075

MEGA-Speed-Drill-Uni | Vollhartmetall-Spiralbohrer SCD221 (8xD), innere Kühlmittelzufuhr

Baumaße						Schaftform HA	
d ₁ h7	d ₂ h6	l ₁	l ₂	l ₃	l ₄	Spezifikation	Bestell-Nr.
10,50	12	162	114	96	45	SCD221-1050-2-3-135HA08-HP374	30404078
11,00	12	162	114	96	45	SCD221-1100-2-3-135HA08-HP374	30404083
11,40	12	162	114	96	45	SCD221-1140-2-3-135HA08-HP374	30404088
11,80	12	162	114	96	45	SCD221-1180-2-3-135HA08-HP374	30404092
12,00	12	162	114	96	45	SCD221-1200-2-3-135HA08-HP374	30404094
12,50	14	178	133	112	45	SCD221-1250-2-3-135HA08-HP374	30404095
13,00	14	178	133	112	45	SCD221-1300-2-3-135HA08-HP374	30404097
13,50	14	178	133	112	45	SCD221-1350-2-3-135HA08-HP374	30404098
14,00	14	178	133	112	45	SCD221-1400-2-3-135HA08-HP374	30404100
15,00	16	203	152	128	48	SCD221-1500-2-3-135HA08-HP374	30404103
16,00	16	203	152	128	48	SCD221-1600-2-3-135HA08-HP374	30404106
17,50	18	222	171	144	48	SCD221-1750-2-3-135HA08-HP374	30404110

Konfigurierbare Merkmale



Durchmesser:
Durchmesser in Abstufungen
von 0,01 mm frei wählbar



Schaftform:
Schaftform: HB | HE

Spezifikation:

SCD221-[Durchmesser]-3-3-140[Schaftform]08-HP374

Abmessungen konfigurierbare Baureihe

d ₁ min.	d ₁ max.	d ₂ h6	l ₁	l ₂	l ₃	l ₄
3,00	3,70	6	72	34	29	36
3,71	4,70	6	81	43	36	36
4,80	6,00	6	95	57	48	36
6,01	8,00	8	114	76	64	36
8,01	10,00	10	142	95	80	40
10,01	12,00	12	162	114	96	45
12,01	14,00	14	178	133	112	45
14,01	16,00	16	203	152	128	48
16,01	18,00	18	222	171	144	48
18,01	20,00	20	243	190	160	50

Beispiel:

SCD221-0431-3-3-140HE08-HP374

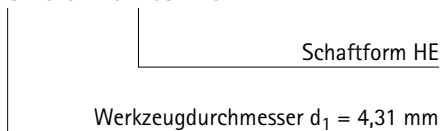

Maßangaben in mm.

Schnittwertempfehlung siehe Kapitelende.

Sonderausführungen und andere Beschichtungen auf Anfrage.

ECU-Drill-Uni

Vollhartmetall-Spiralbohrer
SCD351 (4xD), innere Kühlmittelzufuhr

Ausführung:
Bohrerdurchmesser: 3,00 - 20,00 mm
Bohrungstoleranz: ≥ IT 9
Schneidstoff: HP765
Schneidenanzahl: 2
Spitzenwinkel: 140°
Spiralwinkel: 30°

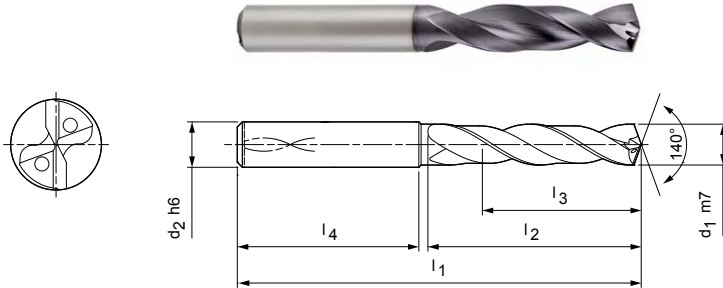

Lagerhaltige Vorzugsbaureihe in Schaftform HA

Baumaße						Schaftform HA	
d ₁ m7	d ₂ h6	l ₁	l ₂	l ₃	l ₄	Spezifikation	Bestell-Nr.
3,00	6	62	22	16	36	SCD351-0300-2-2-140HA04-HP765	30421828
3,10	6	62	22	16	36	SCD351-0310-2-2-140HA04-HP765	30421829
3,20	6	62	22	16	36	SCD351-0320-2-2-140HA04-HP765	30421830
3,30	6	62	22	16	36	SCD351-0330-2-2-140HA04-HP765	30421831
3,40	6	62	22	16	36	SCD351-0340-2-2-140HA04-HP765	30421832
3,50	6	62	22	16	36	SCD351-0350-2-2-140HA04-HP765	30421833
3,60	6	62	22	16	36	SCD351-0360-2-2-140HA04-HP765	30421834
3,70*	6	62	22	16	36	SCD351-0370-2-2-140HA04-HP765	30421835
3,80	6	66	26	22	36	SCD351-0380-2-2-140HA04-HP765	30421836
3,90	6	66	26	22	36	SCD351-0390-2-2-140HA04-HP765	30421837
4,00	6	66	26	22	36	SCD351-0400-2-2-140HA04-HP765	30421838
4,10	6	66	26	22	36	SCD351-0410-2-2-140HA04-HP765	30421839
4,20	6	66	26	22	36	SCD351-0420-2-2-140HA04-HP765	30421840
4,30	6	66	26	22	36	SCD351-0430-2-2-140HA04-HP765	30421842
4,40	6	66	26	22	36	SCD351-0440-2-2-140HA04-HP765	30421843
4,50	6	66	26	22	36	SCD351-0450-2-2-140HA04-HP765	30421844
4,60	6	66	26	22	36	SCD351-0460-2-2-140HA04-HP765	30421845
4,65*	6	66	26	22	36	SCD351-0465-2-2-140HA04-HP765	30421846
4,70	6	66	26	22	36	SCD351-0470-2-2-140HA04-HP765	30421847
4,80	6	66	30	24	36	SCD351-0480-2-2-140HA04-HP765	30421848
4,90	6	66	30	24	36	SCD351-0490-2-2-140HA04-HP765	30421849
5,00	6	66	30	24	36	SCD351-0500-2-2-140HA04-HP765	30421850
5,10	6	66	30	24	36	SCD351-0510-2-2-140HA04-HP765	30421851
5,20	6	66	30	24	36	SCD351-0520-2-2-140HA04-HP765	30421852
5,30	6	66	30	24	36	SCD351-0530-2-2-140HA04-HP765	30421853
5,40	6	66	30	24	36	SCD351-0540-2-2-140HA04-HP765	30421854
5,50	6	66	30	24	36	SCD351-0550-2-2-140HA04-HP765	30421855
5,55*	6	66	30	24	36	SCD351-0555-2-2-140HA04-HP765	30421856
5,60	6	66	30	24	36	SCD351-0560-2-2-140HA04-HP765	30421857
5,70	6	66	30	24	36	SCD351-0570-2-2-140HA04-HP765	30421858
5,80	6	66	30	24	36	SCD351-0580-2-2-140HA04-HP765	30421859
5,90	6	66	30	24	36	SCD351-0590-2-2-140HA04-HP765	30421860
6,00	6	66	30	24	36	SCD351-0600-2-2-140HA04-HP765	30421861
6,10	8	79	38	30	36	SCD351-0610-2-2-140HA04-HP765	30421862

ECU-Drill-Uni | Vollhartmetall-Spiralbohrer SCD351 (4xD), innere Kühlmittelzufuhr

Baumaße						Schaftform HA	
d ₁ m7	d ₂ h6	l ₁	l ₂	l ₃	l ₄	Spezifikation	Bestell-Nr.
6,20	8	79	38	30	36	SCD351-0620-2-2-140HA04-HP765	30421863
6,30	8	79	38	30	36	SCD351-0630-2-2-140HA04-HP765	30421864
6,40	8	79	38	30	36	SCD351-0640-2-2-140HA04-HP765	30421865
6,50	8	79	38	30	36	SCD351-0650-2-2-140HA04-HP765	30421866
6,60	8	79	38	30	36	SCD351-0660-2-2-140HA04-HP765	30421867
6,70	8	79	38	30	36	SCD351-0670-2-2-140HA04-HP765	30421868
6,80	8	79	38	30	36	SCD351-0680-2-2-140HA04-HP765	30421869
6,90	8	79	38	30	36	SCD351-0690-2-2-140HA04-HP765	30421870
7,00	8	79	38	30	36	SCD351-0700-2-2-140HA04-HP765	30421871
7,10	8	79	42	34	36	SCD351-0710-2-2-140HA04-HP765	30421872
7,20	8	79	42	34	36	SCD351-0720-2-2-140HA04-HP765	30421873
7,30	8	79	42	34	36	SCD351-0730-2-2-140HA04-HP765	30421874
7,40	8	79	42	34	36	SCD351-0740-2-2-140HA04-HP765	30421875
7,45*	8	79	42	34	36	SCD351-0745-2-2-140HA04-HP765	30569196
7,50	8	79	42	34	36	SCD351-0750-2-2-140HA04-HP765	30421876
7,60	8	79	42	34	36	SCD351-0760-2-2-140HA04-HP765	30421878
7,70	8	79	42	34	36	SCD351-0770-2-2-140HA04-HP765	30421879
7,80	8	79	42	34	36	SCD351-0780-2-2-140HA04-HP765	30421880
7,90	8	79	42	34	36	SCD351-0790-2-2-140HA04-HP765	30421881
8,00	8	79	42	34	36	SCD351-0800-2-2-140HA04-HP765	30421882
8,10	10	89	49	38	40	SCD351-0810-2-2-140HA04-HP765	30421883
8,20	10	89	49	38	40	SCD351-0820-2-2-140HA04-HP765	30421884
8,30	10	89	49	38	40	SCD351-0830-2-2-140HA04-HP765	30421885
8,40	10	89	49	38	40	SCD351-0840-2-2-140HA04-HP765	30421886
8,50	10	89	49	38	40	SCD351-0850-2-2-140HA04-HP765	30421887
8,60	10	89	49	38	40	SCD351-0860-2-2-140HA04-HP765	30421888
8,70	10	89	49	38	40	SCD351-0870-2-2-140HA04-HP765	30421889
8,80	10	89	49	38	40	SCD351-0880-2-2-140HA04-HP765	30421890
8,90	10	89	49	38	40	SCD351-0890-2-2-140HA04-HP765	30421891
9,00	10	89	49	38	40	SCD351-0900-2-2-140HA04-HP765	30421892
9,10	10	89	49	38	40	SCD351-0910-2-2-140HA04-HP765	30421893
9,20	10	89	49	38	40	SCD351-0920-2-2-140HA04-HP765	30421894
9,30*	10	89	49	40	40	SCD351-0930-2-2-140HA04-HP765	30421896
9,40	10	89	49	40	40	SCD351-0940-2-2-140HA04-HP765	30421897
9,50	10	89	49	40	40	SCD351-0950-2-2-140HA04-HP765	30421898
9,60	10	89	49	40	40	SCD351-0960-2-2-140HA04-HP765	30421899
9,70	10	89	49	40	40	SCD351-0970-2-2-140HA04-HP765	30421900
9,80	10	89	49	40	40	SCD351-0980-2-2-140HA04-HP765	30421901
9,90	10	89	49	40	40	SCD351-0990-2-2-140HA04-HP765	30421902
10,00	10	89	49	40	40	SCD351-1000-2-2-140HA04-HP765	30421903
10,10	12	102	56	45	45	SCD351-1010-2-2-140HA04-HP765	30421904
10,20	12	102	56	45	45	SCD351-1020-2-2-140HA04-HP765	30421905
10,30	12	102	56	45	45	SCD351-1030-2-2-140HA04-HP765	30421906
10,40	12	102	56	45	45	SCD351-1040-2-2-140HA04-HP765	30421907
10,50	12	102	56	45	45	SCD351-1050-2-2-140HA04-HP765	30421908
10,60	12	102	56	45	45	SCD351-1060-2-2-140HA04-HP765	30421909
10,70	12	102	56	45	45	SCD351-1070-2-2-140HA04-HP765	30421910
10,80	12	102	56	45	45	SCD351-1080-2-2-140HA04-HP765	30421911
10,90	12	102	56	45	45	SCD351-1090-2-2-140HA04-HP765	30421912
11,00	12	102	56	45	45	SCD351-1100-2-2-140HA04-HP765	30421913
11,10	12	102	56	45	45	SCD351-1110-2-2-140HA04-HP765	30421914
11,20*	12	102	56	45	45	SCD351-1120-2-2-140HA04-HP765	30421915
11,50	12	102	56	45	45	SCD351-1150-2-2-140HA04-HP765	30421918
11,70	12	102	56	45	45	SCD351-1170-2-2-140HA04-HP765	30421920
11,80	12	102	56	45	45	SCD351-1180-2-2-140HA04-HP765	30421921

Fortsetzung auf nächster Seite.

ECU-Drill-Uni | Vollhartmetall-Spiralbohrer SCD351 (4xD), innere Kühlmittelzufuhr

Baumaße						Schaftform HA	
d ₁ m7	d ₂ h6	l ₁	l ₂	l ₃	l ₄	Spezifikation	Bestell-Nr.
11,90	12	102	56	45	45	SCD351-1190-2-2-140HA04-HP765	30421922
12,00	12	102	56	45	45	SCD351-1200-2-2-140HA04-HP765	30421923
12,20	14	107	61	50	45	SCD351-1220-2-2-140HA04-HP765	30421924
12,50	14	107	61	50	45	SCD351-1250-2-2-140HA04-HP765	30421925
12,70	14	107	61	50	45	SCD351-1270-2-2-140HA04-HP765	30421926
12,80	14	107	61	50	45	SCD351-1280-2-2-140HA04-HP765	30421927
13,00	14	107	61	50	45	SCD351-1300-2-2-140HA04-HP765	30421928
13,50	14	107	61	50	45	SCD351-1350-2-2-140HA04-HP765	30421929
13,80	14	107	61	50	45	SCD351-1380-2-2-140HA04-HP765	30421931
14,00	14	107	61	50	45	SCD351-1400-2-2-140HA04-HP765	30421932
14,20	16	115	65	51	48	SCD351-1420-2-2-140HA04-HP765	30421934
14,50	16	115	65	51	48	SCD351-1450-2-2-140HA04-HP765	30421935
14,80	16	115	65	51	48	SCD351-1480-2-2-140HA04-HP765	30421936
15,00	16	115	65	51	48	SCD351-1500-2-2-140HA04-HP765	30421937
15,10	16	115	65	51	48	SCD351-1510-2-2-140HA04-HP765	30421938
15,20	16	115	65	51	48	SCD351-1520-2-2-140HA04-HP765	30421939
15,50	16	115	65	51	48	SCD351-1550-2-2-140HA04-HP765	30421941
15,70	16	115	65	51	48	SCD351-1570-2-2-140HA04-HP765	30421942
15,80	16	115	65	51	48	SCD351-1580-2-2-140HA04-HP765	30421943
16,00	16	115	65	51	48	SCD351-1600-2-2-140HA04-HP765	30421944
16,50	18	123	73	53	48	SCD351-1650-2-2-140HA04-HP765	30421946
16,80	18	123	73	53	48	SCD351-1680-2-2-140HA04-HP765	30569199
17,00	18	123	73	53	48	SCD351-1700-2-2-140HA04-HP765	30421947
17,30	18	123	73	53	48	SCD351-1730-2-2-140HA04-HP765	30421949
17,50	18	123	73	53	48	SCD351-1750-2-2-140HA04-HP765	30421950
17,70	18	123	73	53	48	SCD351-1770-2-2-140HA04-HP765	30421951
18,00	18	123	73	53	48	SCD351-1800-2-2-140HA04-HP765	30421952
18,50	20	131	79	55	50	SCD351-1850-2-2-140HA04-HP765	30421953
19,00	20	131	79	55	50	SCD351-1900-2-2-140HA04-HP765	30421954
19,50	20	131	79	55	50	SCD351-1950-2-2-140HA04-HP765	30421956
20,00	20	131	79	55	50	SCD351-2000-2-2-140HA04-HP765	30421957

Konfigurierbare Merkmale



Schaftform:
Schaftform: HB | HE

**Spezifikation:**

SCD351-0430-3-3-140[Schaftform]04-HP765

Beispiel:

SCD351-0430-3-3-140HE04-HP765

Schaftform HE

Maßangaben in mm.

* Speziell zur Vorfertigung der Kernlöcher für Gewindeformer geeignet.

Schnittwertempfehlung siehe Kapitelende.

Sonderausführungen und andere Beschichtungen auf Anfrage.

ECU-Drill-Uni

Vollhartmetall-Spiralbohrer
SCD350 (4xD), äußere Kühlmittelzufuhr

Ausführung:

Bohrerdurchmesser: 3,00 - 20,00 mm
Bohrungstoleranz: \geq IT 9
Schneidstoff: HP765
Schneidenanzahl: 2
Spitzenwinkel: 140°
Spiralwinkel: 30°

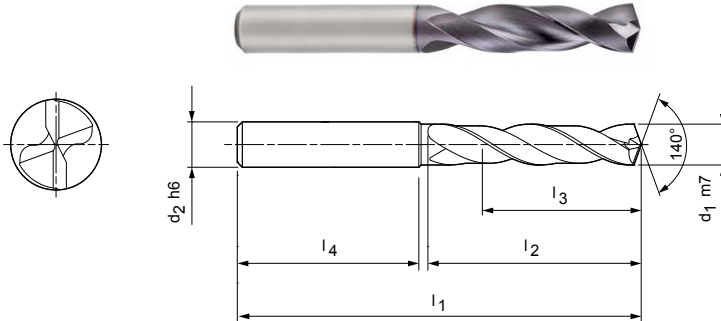

Lagerhaltige Vorzugsbaureihe in Schaftform HA

Baumaße						Schaftform HA	
d ₁ m7	d ₂ h6	l ₁	l ₂	l ₃	l ₄	Spezifikation	Bestell-Nr.
3,00	6	62	22	16	36	SCD350-0300-2-2-140HA04-HP765	30421694
3,10	6	62	22	16	36	SCD350-0310-2-2-140HA04-HP765	30421696
3,20	6	62	22	16	36	SCD350-0320-2-2-140HA04-HP765	30421697
3,30	6	62	22	16	36	SCD350-0330-2-2-140HA04-HP765	30421698
3,40	6	62	22	16	36	SCD350-0340-2-2-140HA04-HP765	30421699
3,50	6	62	22	16	36	SCD350-0350-2-2-140HA04-HP765	30421700
3,60	6	62	22	16	36	SCD350-0360-2-2-140HA04-HP765	30421701
3,70*	6	62	22	16	36	SCD350-0370-2-2-140HA04-HP765	30421703
3,80	6	66	26	22	36	SCD350-0380-2-2-140HA04-HP765	30421704
3,90	6	66	26	22	36	SCD350-0390-2-2-140HA04-HP765	30421705
4,00	6	66	26	22	36	SCD350-0400-2-2-140HA04-HP765	30421706
4,10	6	66	26	22	36	SCD350-0410-2-2-140HA04-HP765	30421707
4,20	6	66	26	22	36	SCD350-0420-2-2-140HA04-HP765	30421708
4,30	6	66	26	22	36	SCD350-0430-2-2-140HA04-HP765	30421709
4,40	6	66	26	22	36	SCD350-0440-2-2-140HA04-HP765	30421710
4,50	6	66	26	22	36	SCD350-0450-2-2-140HA04-HP765	30421711
4,60	6	66	26	22	36	SCD350-0460-2-2-140HA04-HP765	30421712
4,65*	6	66	26	22	36	SCD350-0465-2-2-140HA04-HP765	30421713
4,70	6	66	26	22	36	SCD350-0470-2-2-140HA04-HP765	30421714
4,80	6	66	30	24	36	SCD350-0480-2-2-140HA04-HP765	30421715
4,90	6	66	30	24	36	SCD350-0490-2-2-140HA04-HP765	30421716
5,00	6	66	30	24	36	SCD350-0500-2-2-140HA04-HP765	30421717
5,10	6	66	30	24	36	SCD350-0510-2-2-140HA04-HP765	30421718
5,20	6	66	30	24	36	SCD350-0520-2-2-140HA04-HP765	30421719
5,30	6	66	30	24	36	SCD350-0530-2-2-140HA04-HP765	30421720
5,40	6	66	30	24	36	SCD350-0540-2-2-140HA04-HP765	30421721
5,50	6	66	30	24	36	SCD350-0550-2-2-140HA04-HP765	30421722
5,55*	6	66	30	24	36	SCD350-0555-2-2-140HA04-HP765	30421723
5,60	6	66	30	24	36	SCD350-0560-2-2-140HA04-HP765	30421725
5,70	6	66	30	24	36	SCD350-0570-2-2-140HA04-HP765	30421726
5,80	6	66	30	24	36	SCD350-0580-2-2-140HA04-HP765	30421727
5,90	6	66	30	24	36	SCD350-0590-2-2-140HA04-HP765	30421728
6,00	6	66	30	24	36	SCD350-0600-2-2-140HA04-HP765	30421731
6,10	8	79	38	30	36	SCD350-0610-2-2-140HA04-HP765	30421732

Fortsetzung auf nächster Seite.

ECU-Drill-Uni | Vollhartmetall-Spiralbohrer SCD350 (4xD), äußere Kühlmittelzufuhr

Baumaße						Schaftform HA	
d ₁ m7	d ₂ h6	l ₁	l ₂	l ₃	l ₄	Spezifikation	Bestell-Nr.
6,20	8	79	38	30	36	SCD350-0620-2-2-140HA04-HP765	30421733
6,30	8	79	38	30	36	SCD350-0630-2-2-140HA04-HP765	30421734
6,40	8	79	38	30	36	SCD350-0640-2-2-140HA04-HP765	30421735
6,50	8	79	38	30	36	SCD350-0650-2-2-140HA04-HP765	30421736
6,60	8	79	38	30	36	SCD350-0660-2-2-140HA04-HP765	30421737
6,70	8	79	38	30	36	SCD350-0670-2-2-140HA04-HP765	30421738
6,80	8	79	38	30	36	SCD350-0680-2-2-140HA04-HP765	30421739
6,90	8	79	38	30	36	SCD350-0690-2-2-140HA04-HP765	30421740
7,00	8	79	38	30	36	SCD350-0700-2-2-140HA04-HP765	30421741
7,10	8	79	42	34	36	SCD350-0710-2-2-140HA04-HP765	30421742
7,20	8	79	42	34	36	SCD350-0720-2-2-140HA04-HP765	30421743
7,30	8	79	42	34	36	SCD350-0730-2-2-140HA04-HP765	30421744
7,40	8	79	42	34	36	SCD350-0740-2-2-140HA04-HP765	30421745
7,50	8	79	42	34	36	SCD350-0750-2-2-140HA04-HP765	30421746
7,60	8	79	42	34	36	SCD350-0760-2-2-140HA04-HP765	30421748
7,70	8	79	42	34	36	SCD350-0770-2-2-140HA04-HP765	30421749
7,80	8	79	42	34	36	SCD350-0780-2-2-140HA04-HP765	30421750
7,90	8	79	42	34	36	SCD350-0790-2-2-140HA04-HP765	30421751
8,00	8	79	42	34	36	SCD350-0800-2-2-140HA04-HP765	30421752
8,10	10	89	49	38	40	SCD350-0810-2-2-140HA04-HP765	30421753
8,20	10	89	49	38	40	SCD350-0820-2-2-140HA04-HP765	30421754
8,30	10	89	49	38	40	SCD350-0830-2-2-140HA04-HP765	30421755
8,40	10	89	49	38	40	SCD350-0840-2-2-140HA04-HP765	30421756
8,50	10	89	49	38	40	SCD350-0850-2-2-140HA04-HP765	30421757
8,60	10	89	49	38	40	SCD350-0860-2-2-140HA04-HP765	30421758
8,70	10	89	49	38	40	SCD350-0870-2-2-140HA04-HP765	30421759
8,80	10	89	49	38	40	SCD350-0880-2-2-140HA04-HP765	30421760
8,90	10	89	49	38	40	SCD350-0890-2-2-140HA04-HP765	30421761
9,00	10	89	49	38	40	SCD350-0900-2-2-140HA04-HP765	30421762
9,10	10	89	49	38	40	SCD350-0910-2-2-140HA04-HP765	30421763
9,20	10	89	49	38	40	SCD350-0920-2-2-140HA04-HP765	30421764
9,30*	10	89	49	40	40	SCD350-0930-2-2-140HA04-HP765	30421766
9,40	10	89	49	40	40	SCD350-0940-2-2-140HA04-HP765	30421767
9,50	10	89	49	40	40	SCD350-0950-2-2-140HA04-HP765	30421768
9,60	10	89	49	40	40	SCD350-0960-2-2-140HA04-HP765	30421769
9,70	10	89	49	40	40	SCD350-0970-2-2-140HA04-HP765	30421770
9,80	10	89	49	40	40	SCD350-0980-2-2-140HA04-HP765	30421771
9,90	10	89	49	40	40	SCD350-0990-2-2-140HA04-HP765	30421772
10,00	10	89	49	40	40	SCD350-1000-2-2-140HA04-HP765	30421773
10,10	12	102	56	45	45	SCD350-1010-2-2-140HA04-HP765	30421774
10,20	12	102	56	45	45	SCD350-1020-2-2-140HA04-HP765	30421775
10,30	12	102	56	45	45	SCD350-1030-2-2-140HA04-HP765	30421776
10,40	12	102	56	45	45	SCD350-1040-2-2-140HA04-HP765	30421777
10,50	12	102	56	45	45	SCD350-1050-2-2-140HA04-HP765	30421778
10,60	12	102	56	45	45	SCD350-1060-2-2-140HA04-HP765	30421779
10,80	12	102	56	45	45	SCD350-1080-2-2-140HA04-HP765	30421781
10,90	12	102	56	45	45	SCD350-1090-2-2-140HA04-HP765	30421782
11,00	12	102	56	45	45	SCD350-1100-2-2-140HA04-HP765	30421783
11,10	12	102	56	45	45	SCD350-1110-2-2-140HA04-HP765	30421784
11,20*	12	102	56	45	45	SCD350-1120-2-2-140HA04-HP765	30421785
11,30	12	102	56	45	45	SCD350-1130-2-2-140HA04-HP765	30421786
11,40	12	102	56	45	45	SCD350-1140-2-2-140HA04-HP765	30421787
11,50	12	102	56	45	45	SCD350-1150-2-2-140HA04-HP765	30421788
11,60	12	102	56	45	45	SCD350-1160-2-2-140HA04-HP765	30421789
11,70	12	102	56	45	45	SCD350-1170-2-2-140HA04-HP765	30421790

ECU-Drill-Uni | Vollhartmetall-Spiralbohrer SCD350 (4xD), äußere Kühlmittelzufuhr

Baumaße						Schaftform HA	
d ₁ m7	d ₂ h6	l ₁	l ₂	l ₃	l ₄	Spezifikation	Bestell-Nr.
11,80	12	102	56	45	45	SCD350-1180-2-2-140HA04-HP765	30421791
12,00	12	102	56	45	45	SCD350-1200-2-2-140HA04-HP765	30421793
12,20	14	107	61	50	45	SCD350-1220-2-2-140HA04-HP765	30421794
12,50	14	107	61	50	45	SCD350-1250-2-2-140HA04-HP765	30421795
12,80	14	107	61	50	45	SCD350-1280-2-2-140HA04-HP765	30421798
13,00	14	107	61	50	45	SCD350-1300-2-2-140HA04-HP765	30421799
13,50	14	107	61	50	45	SCD350-1350-2-2-140HA04-HP765	30421800
13,80	14	107	61	50	45	SCD350-1380-2-2-140HA04-HP765	30421802
14,00	14	107	61	50	45	SCD350-1400-2-2-140HA04-HP765	30421803
14,20	16	115	65	51	48	SCD350-1420-2-2-140HA04-HP765	30421804
14,50	16	115	65	51	48	SCD350-1450-2-2-140HA04-HP765	30421805
14,80	16	115	65	51	48	SCD350-1480-2-2-140HA04-HP765	30421807
15,00	16	115	65	51	48	SCD350-1500-2-2-140HA04-HP765	30421808
15,10	16	115	65	51	48	SCD350-1510-2-2-140HA04-HP765	30421809
15,20	16	115	65	51	48	SCD350-1520-2-2-140HA04-HP765	30421810
15,50	16	115	65	51	48	SCD350-1550-2-2-140HA04-HP765	30421811
15,70	16	115	65	51	48	SCD350-1570-2-2-140HA04-HP765	30421813
15,80	16	115	65	51	48	SCD350-1580-2-2-140HA04-HP765	30421814
16,00	16	115	65	51	48	SCD350-1600-2-2-140HA04-HP765	30421815
16,50	18	123	73	53	48	SCD350-1650-2-2-140HA04-HP765	30421817
17,00	18	123	73	53	48	SCD350-1700-2-2-140HA04-HP765	30421818
17,50	18	123	73	53	48	SCD350-1750-2-2-140HA04-HP765	30421820
17,70	18	123	73	53	48	SCD350-1770-2-2-140HA04-HP765	30421821
18,00	18	123	73	53	48	SCD350-1800-2-2-140HA04-HP765	30421822
18,50	20	131	79	55	50	SCD350-1850-2-2-140HA04-HP765	30421823
19,00	20	131	79	55	50	SCD350-1900-2-2-140HA04-HP765	30421824
19,50	20	131	79	55	50	SCD350-1950-2-2-140HA04-HP765	30421826
20,00	20	131	79	55	50	SCD350-2000-2-2-140HA04-HP765	30421827

Konfigurierbare Merkmale



Schaftform:
Schaftform: HB | HE

**Spezifikation:**

SCD350-0430-3-3-140[**Schaftform**]04-HP765

Beispiel:
SCD350-0430-3-3-140HE04-HP765

Schaftform HE

Maßangaben in mm.

* Speziell zur Vorfertigung der Kernlöcher für Gewindeformer geeignet.

Schnittwertempfehlung siehe Kapitelende.

Sonderausführungen und andere Beschichtungen auf Anfrage.

ECU-Drill-Uni

Vollhartmetall-Spiralbohrer
SCD351 (6xD), innere Kühlmittelzufuhr

Ausführung:

Bohrerdurchmesser: 3,00 - 20,00 mm
Bohrungstoleranz: \geq IT 9
Schneidstoff: HP765
Schneidenanzahl: 2
Spitzenwinkel: 140°
Spiralwinkel: 30°

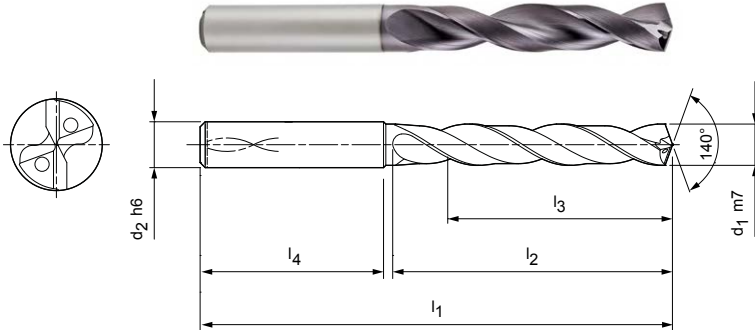

Lagerhaltige Vorzugsbaureihe in Schaftform HA

Baumaße						Schaftform HA	
d ₁ m7	d ₂ h6	l ₁	l ₂	l ₃	l ₄	Spezifikation	Bestell-Nr.
3,00	6	66	28	23	36	SCD351-0300-2-2-140HA06-HP765	30421958
3,10	6	66	28	23	36	SCD351-0310-2-2-140HA06-HP765	30421959
3,20	6	66	28	23	36	SCD351-0320-2-2-140HA06-HP765	30421960
3,30	6	66	28	23	36	SCD351-0330-2-2-140HA06-HP765	30421961
3,40	6	66	28	23	36	SCD351-0340-2-2-140HA06-HP765	30421962
3,50	6	66	28	23	36	SCD351-0350-2-2-140HA06-HP765	30421963
3,60	6	66	28	23	36	SCD351-0360-2-2-140HA06-HP765	30421964
3,70*	6	66	28	23	36	SCD351-0370-2-2-140HA06-HP765	30421965
3,80	6	74	36	29	36	SCD351-0380-2-2-140HA06-HP765	30421966
3,90	6	74	36	29	36	SCD351-0390-2-2-140HA06-HP765	30421967
4,00	6	74	36	29	36	SCD351-0400-2-2-140HA06-HP765	30421968
4,10	6	74	36	29	36	SCD351-0410-2-2-140HA06-HP765	30421969
4,20	6	74	36	29	36	SCD351-0420-2-2-140HA06-HP765	30421970
4,30	6	74	36	29	36	SCD351-0430-2-2-140HA06-HP765	30421971
4,40	6	74	36	29	36	SCD351-0440-2-2-140HA06-HP765	30421972
4,50	6	74	36	29	36	SCD351-0450-2-2-140HA06-HP765	30421973
4,60	6	74	36	29	36	SCD351-0460-2-2-140HA06-HP765	30421974
4,65*	6	74	36	29	36	SCD351-0465-2-2-140HA06-HP765	30421975
4,70	6	74	36	29	36	SCD351-0470-2-2-140HA06-HP765	30421976
4,80	6	82	44	35	36	SCD351-0480-2-2-140HA06-HP765	30421977
4,90	6	82	44	35	36	SCD351-0490-2-2-140HA06-HP765	30421978
5,00	6	82	44	35	36	SCD351-0500-2-2-140HA06-HP765	30421979
5,10	6	82	44	35	36	SCD351-0510-2-2-140HA06-HP765	30421980
5,20	6	82	44	35	36	SCD351-0520-2-2-140HA06-HP765	30421981
5,30	6	82	44	35	36	SCD351-0530-2-2-140HA06-HP765	30421982
5,40	6	82	44	35	36	SCD351-0540-2-2-140HA06-HP765	30421983
5,50	6	82	44	35	36	SCD351-0550-2-2-140HA06-HP765	30421984
5,55*	6	82	44	35	36	SCD351-0555-2-2-140HA06-HP765	30421985
5,60	6	82	44	35	36	SCD351-0560-2-2-140HA06-HP765	30421987
5,70	6	82	44	35	36	SCD351-0570-2-2-140HA06-HP765	30421988
5,80	6	82	44	35	36	SCD351-0580-2-2-140HA06-HP765	30421989
5,90	6	82	44	35	36	SCD351-0590-2-2-140HA06-HP765	30421990
6,00	6	82	44	35	36	SCD351-0600-2-2-140HA06-HP765	30421991
6,10	8	91	53	43	36	SCD351-0610-2-2-140HA06-HP765	30421992
6,20	8	91	53	43	36	SCD351-0620-2-2-140HA06-HP765	30421993

ECU-Drill-Uni | Vollhartmetall-Spiralbohrer SCD351 (6xD), innere Kühlmittelzufuhr

Baumaße						Schaftform HA	
d ₁ m7	d ₂ h6	l ₁	l ₂	l ₃	l ₄	Spezifikation	Bestell-Nr.
6,30	8	91	53	43	36	SCD351-0630-2-2-140HA06-HP765	30421994
6,40	8	91	53	43	36	SCD351-0640-2-2-140HA06-HP765	30421995
6,50	8	91	53	43	36	SCD351-0650-2-2-140HA06-HP765	30421996
6,60	8	91	53	43	36	SCD351-0660-2-2-140HA06-HP765	30421997
6,70	8	91	53	43	36	SCD351-0670-2-2-140HA06-HP765	30421998
6,80	8	91	53	43	36	SCD351-0680-2-2-140HA06-HP765	30421999
6,90	8	91	53	43	36	SCD351-0690-2-2-140HA06-HP765	30422000
7,00	8	91	53	43	36	SCD351-0700-2-2-140HA06-HP765	30422001
7,10	8	91	53	43	36	SCD351-0710-2-2-140HA06-HP765	30422002
7,20	8	91	53	43	36	SCD351-0720-2-2-140HA06-HP765	30422003
7,30	8	91	53	43	36	SCD351-0730-2-2-140HA06-HP765	30422004
7,40	8	91	53	43	36	SCD351-0740-2-2-140HA06-HP765	30422005
7,45*	8	91	53	43	36	SCD351-0745-2-2-140HA06-HP765	30569230
7,50	8	91	53	43	36	SCD351-0750-2-2-140HA06-HP765	30422006
7,60	8	91	53	43	36	SCD351-0760-2-2-140HA06-HP765	30422008
7,70	8	91	53	43	36	SCD351-0770-2-2-140HA06-HP765	30422009
7,80	8	91	53	43	36	SCD351-0780-2-2-140HA06-HP765	30422010
7,90	8	91	53	43	36	SCD351-0790-2-2-140HA06-HP765	30422011
8,00	8	91	53	43	36	SCD351-0800-2-2-140HA06-HP765	30422012
8,10	10	103	61	49	40	SCD351-0810-2-2-140HA06-HP765	30422013
8,20	10	103	61	49	40	SCD351-0820-2-2-140HA06-HP765	30422014
8,30	10	103	61	49	40	SCD351-0830-2-2-140HA06-HP765	30422015
8,40	10	103	61	49	40	SCD351-0840-2-2-140HA06-HP765	30422016
8,50	10	103	61	49	40	SCD351-0850-2-2-140HA06-HP765	30422017
8,60	10	103	61	49	40	SCD351-0860-2-2-140HA06-HP765	30422018
8,70	10	103	61	49	40	SCD351-0870-2-2-140HA06-HP765	30422019
8,80	10	103	61	49	40	SCD351-0880-2-2-140HA06-HP765	30422020
8,90	10	103	61	49	40	SCD351-0890-2-2-140HA06-HP765	30422021
9,00	10	103	61	49	40	SCD351-0900-2-2-140HA06-HP765	30422022
9,10	10	103	61	49	40	SCD351-0910-2-2-140HA06-HP765	30422023
9,20	10	103	61	49	40	SCD351-0920-2-2-140HA06-HP765	30422024
9,30*	10	103	61	49	40	SCD351-0930-2-2-140HA06-HP765	30422026
9,40	10	103	61	49	40	SCD351-0940-2-2-140HA06-HP765	30422027
9,50	10	103	61	49	40	SCD351-0950-2-2-140HA06-HP765	30422028
9,60	10	103	61	49	40	SCD351-0960-2-2-140HA06-HP765	30422029
9,70	10	103	61	49	40	SCD351-0970-2-2-140HA06-HP765	30422030
9,80	10	103	61	49	40	SCD351-0980-2-2-140HA06-HP765	30422031
9,90	10	103	61	49	40	SCD351-0990-2-2-140HA06-HP765	30422032
10,00	10	103	61	49	40	SCD351-1000-2-2-140HA06-HP765	30422033
10,10	12	118	71	56	45	SCD351-1010-2-2-140HA06-HP765	30422034
10,20	12	118	71	56	45	SCD351-1020-2-2-140HA06-HP765	30422035
10,30	12	118	71	56	45	SCD351-1030-2-2-140HA06-HP765	30422036
10,40	12	118	71	56	45	SCD351-1040-2-2-140HA06-HP765	30422037
10,50	12	118	71	56	45	SCD351-1050-2-2-140HA06-HP765	30422038
10,60	12	118	71	56	45	SCD351-1060-2-2-140HA06-HP765	30422039
10,70	12	118	71	56	45	SCD351-1070-2-2-140HA06-HP765	30422040
10,80	12	118	71	56	45	SCD351-1080-2-2-140HA06-HP765	30422041
10,90	12	118	71	56	45	SCD351-1090-2-2-140HA06-HP765	30422042
11,00	12	118	71	56	45	SCD351-1100-2-2-140HA06-HP765	30422043
11,10	12	118	71	56	45	SCD351-1110-2-2-140HA06-HP765	30422044
11,20*	12	118	71	56	45	SCD351-1120-2-2-140HA06-HP765	30422045
11,30	12	118	71	56	45	SCD351-1130-2-2-140HA06-HP765	30422046
11,50	12	118	71	56	45	SCD351-1150-2-2-140HA06-HP765	30422048
11,60	12	118	71	56	45	SCD351-1160-2-2-140HA06-HP765	30422049
11,80	12	118	71	56	45	SCD351-1180-2-2-140HA06-HP765	30422051
11,90	12	118	71	56	45	SCD351-1190-2-2-140HA06-HP765	30422052
12,00	12	118	71	56	45	SCD351-1200-2-2-140HA06-HP765	30422053

Fortsetzung auf nächster Seite.

ECU-Drill-Uni | Vollhartmetall-Spiralbohrer SCD351 (6xD), innere Kühlmittelzufuhr

Baumaße						Schaftform HA	
d ₁ m7	d ₂ h6	l ₁	l ₂	l ₃	l ₄	Spezifikation	Bestell-Nr.
12,20	14	124	77	60	45	SCD351-1220-2-2-140HA06-HP765	30422054
12,50	14	124	77	60	45	SCD351-1250-2-2-140HA06-HP765	30422055
12,70	14	124	77	60	45	SCD351-1270-2-2-140HA06-HP765	30422056
12,80	14	124	77	60	45	SCD351-1280-2-2-140HA06-HP765	30422057
13,00	14	124	77	60	45	SCD351-1300-2-2-140HA06-HP765	30422058
13,50	14	124	77	60	45	SCD351-1350-2-2-140HA06-HP765	30422059
13,70	14	124	77	60	45	SCD351-1370-2-2-140HA06-HP765	30422060
13,80	14	124	77	60	45	SCD351-1380-2-2-140HA06-HP765	30422061
14,00	14	124	77	60	45	SCD351-1400-2-2-140HA06-HP765	30422062
14,20	16	133	83	63	48	SCD351-1420-2-2-140HA06-HP765	30422063
14,50	16	133	83	63	48	SCD351-1450-2-2-140HA06-HP765	30422064
14,80	16	133	83	63	48	SCD351-1480-2-2-140HA06-HP765	30422066
15,00	16	133	83	63	48	SCD351-1500-2-2-140HA06-HP765	30422067
15,50	16	133	83	63	48	SCD351-1550-2-2-140HA06-HP765	30422069
15,70	16	133	83	63	48	SCD351-1570-2-2-140HA06-HP765	30422070
15,80	16	133	83	63	48	SCD351-1580-2-2-140HA06-HP765	30422071
16,00	16	133	83	63	48	SCD351-1600-2-2-140HA06-HP765	30422072
16,50	18	143	93	71	48	SCD351-1650-2-2-140HA06-HP765	30422073
17,00	18	143	93	71	48	SCD351-1700-2-2-140HA06-HP765	30422074
17,50	18	143	93	71	48	SCD351-1750-2-2-140HA06-HP765	30422075
18,00	18	143	93	71	48	SCD351-1800-2-2-140HA06-HP765	30422076
18,50	20	153	101	77	50	SCD351-1850-2-2-140HA06-HP765	30422077
19,00	20	153	101	77	50	SCD351-1900-2-2-140HA06-HP765	30422078
19,50	20	153	101	77	50	SCD351-1950-2-2-140HA06-HP765	30422079
20,00	20	153	101	77	50	SCD351-2000-2-2-140HA06-HP765	30422080

Konfigurierbare Merkmale



Schaftform:
Schaftform: HB | HE

**Spezifikation:**

SCD351-0430-3-3-140[**Schaftform**]06-HP765

Beispiel:

SCD351-0430-3-3-140HE06-HP765

Schaftform HE

Maßangaben in mm.

* Speziell zur Vorfertigung der Kernlöcher für Gewindeformer geeignet.

Schnittwertempfehlung siehe Kapitelende.

Sonderausführungen und andere Beschichtungen auf Anfrage.

MEGA-Drill-Steel-Plus

Vollhartmetall-Spiralbohrer

SCD600 (3xD), äußere Kühlmittelzufuhr, Nachfolgeprodukt des MEGA-Drill-Steel (SCD10)

Ausführung:

Bohrerdurchmesser:	3,00 – 25,00 mm
Bohrungstoleranz:	≥ IT 9
Schneidstoff:	HP358
Schneidenanzahl:	2
Anzahl Führungsfasen:	2
Spitzenwinkel:	140°
Spiralwinkel:	30°

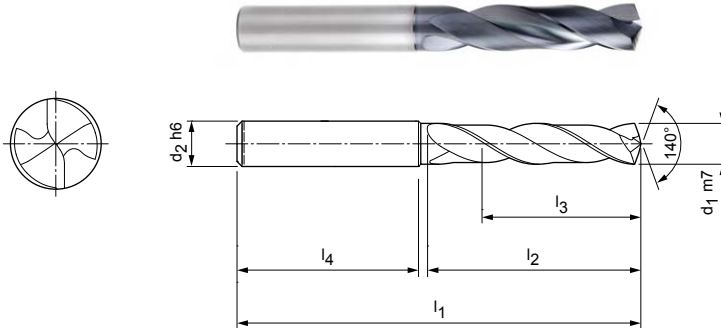

Lagerhaltige Vorzugsbaureihe in Schaftform HA

Baumaße						Schaftform HA	
d ₁ m7	d ₂ h6	l ₁	l ₂	l ₃	l ₄	Spezifikation	Bestell-Nr.
3,00	6	62	20	14	36	SCD600-0300-2-2-140HA03-HP358	30801131
3,10	6	62	20	14	36	SCD600-0310-2-2-140HA03-HP358	30801132
3,15	6	62	20	14	36	SCD600-0315-2-2-140HA03-HP358	30801133
3,20	6	62	20	14	36	SCD600-0320-2-2-140HA03-HP358	30801134
3,25	6	62	20	14	36	SCD600-0325-2-2-140HA03-HP358	30801136
3,30	6	62	20	14	36	SCD600-0330-2-2-140HA03-HP358	30801137
3,40	6	62	20	14	36	SCD600-0340-2-2-140HA03-HP358	30801138
3,50	6	62	20	14	36	SCD600-0350-2-2-140HA03-HP358	30801139
3,60	6	62	20	14	36	SCD600-0360-2-2-140HA03-HP358	30801140
3,70*	6	62	20	14	36	SCD600-0370-2-2-140HA03-HP358	30801141
3,80	6	66	24	17	36	SCD600-0380-2-2-140HA03-HP358	30801142
3,85	6	66	24	17	36	SCD600-0385-2-2-140HA03-HP358	30801143
3,90	6	66	24	17	36	SCD600-0390-2-2-140HA03-HP358	30801144
4,00	6	66	24	17	36	SCD600-0400-2-2-140HA03-HP358	30801145
4,10	6	66	24	17	36	SCD600-0410-2-2-140HA03-HP358	30801146
4,20	6	66	24	17	36	SCD600-0420-2-2-140HA03-HP358	30801147
4,25	6	66	24	17	36	SCD600-0425-2-2-140HA03-HP358	30801148
4,30	6	66	24	17	36	SCD600-0430-2-2-140HA03-HP358	30801149
4,35	6	66	24	17	36	SCD600-0435-2-2-140HA03-HP358	30801150
4,40	6	66	24	17	36	SCD600-0440-2-2-140HA03-HP358	30801151
4,45	6	66	24	17	36	SCD600-0445-2-2-140HA03-HP358	30801152
4,50	6	66	24	17	36	SCD600-0450-2-2-140HA03-HP358	30801153
4,60	6	66	24	17	36	SCD600-0460-2-2-140HA03-HP358	30801154
4,65*	6	66	24	17	36	SCD600-0465-2-2-140HA03-HP358	30801155
4,70	6	66	24	17	36	SCD600-0470-2-2-140HA03-HP358	30801156
4,80	6	66	28	20	36	SCD600-0480-2-2-140HA03-HP358	30801157
4,90	6	66	28	20	36	SCD600-0490-2-2-140HA03-HP358	30801158
4,95	6	66	28	20	36	SCD600-0495-2-2-140HA03-HP358	30801159
5,00	6	66	28	20	36	SCD600-0500-2-2-140HA03-HP358	30801160
5,05	6	66	28	20	36	SCD600-0505-2-2-140HA03-HP358	30801161
5,10	6	66	28	20	36	SCD600-0510-2-2-140HA03-HP358	30801162
5,20	6	66	28	20	36	SCD600-0520-2-2-140HA03-HP358	30801163
5,30	6	66	28	20	36	SCD600-0530-2-2-140HA03-HP358	30801164
5,40	6	66	28	20	36	SCD600-0540-2-2-140HA03-HP358	30801165
5,50	6	66	28	20	36	SCD600-0550-2-2-140HA03-HP358	30801166

Fortsetzung auf nächster Seite.

MEGA-Drill-Steel-Plus | Vollhartmetall-Spiralbohrer SCD600 (3xD), äußere Kühlmittelzufuhr

Baumaße						Schaftform HA	
d ₁ m7	d ₂ h6	l ₁	l ₂	l ₃	l ₄	Spezifikation	Bestell-Nr.
5,55*	6	66	28	20	36	SCD600-0555-2-2-140HA03-HP358	30801167
5,60	6	66	28	20	36	SCD600-0560-2-2-140HA03-HP358	30801168
5,70	6	66	28	20	36	SCD600-0570-2-2-140HA03-HP358	30801169
5,75	6	66	28	20	36	SCD600-0575-2-2-140HA03-HP358	30801170
5,80	6	66	28	20	36	SCD600-0580-2-2-140HA03-HP358	30801171
5,90	6	66	28	20	36	SCD600-0590-2-2-140HA03-HP358	30801172
5,95	6	66	28	20	36	SCD600-0595-2-2-140HA03-HP358	30801173
6,00	6	66	28	20	36	SCD600-0600-2-2-140HA03-HP358	30801174
6,10	8	79	34	24	36	SCD600-0610-2-2-140HA03-HP358	30801175
6,20	8	79	34	24	36	SCD600-0620-2-2-140HA03-HP358	30801176
6,30	8	79	34	24	36	SCD600-0630-2-2-140HA03-HP358	30801177
6,40	8	79	34	24	36	SCD600-0640-2-2-140HA03-HP358	30801178
6,50	8	79	34	24	36	SCD600-0650-2-2-140HA03-HP358	30801179
6,60	8	79	34	24	36	SCD600-0660-2-2-140HA03-HP358	30801180
6,70	8	79	34	24	36	SCD600-0670-2-2-140HA03-HP358	30801181
6,80	8	79	34	24	36	SCD600-0680-2-2-140HA03-HP358	30801182
6,90	8	79	34	24	36	SCD600-0690-2-2-140HA03-HP358	30801183
7,00	8	79	34	24	36	SCD600-0700-2-2-140HA03-HP358	30801184
7,10	8	79	41	29	36	SCD600-0710-2-2-140HA03-HP358	30801185
7,20	8	79	41	29	36	SCD600-0720-2-2-140HA03-HP358	30801186
7,30	8	79	41	29	36	SCD600-0730-2-2-140HA03-HP358	30801187
7,40	8	79	41	29	36	SCD600-0740-2-2-140HA03-HP358	30801188
7,45*	8	79	41	29	36	SCD600-0745-2-2-140HA03-HP358	30801189
7,50	8	79	41	29	36	SCD600-0750-2-2-140HA03-HP358	30801190
7,60	8	79	41	29	36	SCD600-0760-2-2-140HA03-HP358	30801191
7,70	8	79	41	29	36	SCD600-0770-2-2-140HA03-HP358	30801192
7,80	8	79	41	29	36	SCD600-0780-2-2-140HA03-HP358	30801193
7,90	8	79	41	29	36	SCD600-0790-2-2-140HA03-HP358	30801194
8,00	8	79	41	29	36	SCD600-0800-2-2-140HA03-HP358	30801195
8,10	10	89	47	35	40	SCD600-0810-2-2-140HA03-HP358	30801196
8,20	10	89	47	35	40	SCD600-0820-2-2-140HA03-HP358	30801197
9,10	10	89	47	35	40	SCD600-0910-2-2-140HA03-HP358	30801206
9,20	10	89	47	35	40	SCD600-0920-2-2-140HA03-HP358	30801207
9,30*	10	89	47	35	40	SCD600-0930-2-2-140HA03-HP358	30801208
9,35	10	89	47	35	40	SCD600-0935-2-2-140HA03-HP358	30801209
9,50	10	89	47	35	40	SCD600-0950-2-2-140HA03-HP358	30801212
9,60	10	89	47	35	40	SCD600-0960-2-2-140HA03-HP358	30801213
9,70	10	89	47	35	40	SCD600-0970-2-2-140HA03-HP358	30801214
9,80	10	89	47	35	40	SCD600-0980-2-2-140HA03-HP358	30801215
9,90	10	89	47	35	40	SCD600-0990-2-2-140HA03-HP358	30801216
10,00	10	89	47	35	40	SCD600-1000-2-2-140HA03-HP358	30801217
10,10	12	102	55	40	45	SCD600-1010-2-2-140HA03-HP358	30801218
10,20	12	102	55	40	45	SCD600-1020-2-2-140HA03-HP358	30801219
10,30	12	102	55	40	45	SCD600-1030-2-2-140HA03-HP358	30801220
10,40	12	102	55	40	45	SCD600-1040-2-2-140HA03-HP358	30801221
10,50	12	102	55	40	45	SCD600-1050-2-2-140HA03-HP358	30801222
10,55	12	102	55	40	45	SCD600-1055-2-2-140HA03-HP358	30801223
10,60	12	102	55	40	45	SCD600-1060-2-2-140HA03-HP358	30801224
10,70	12	102	55	40	45	SCD600-1070-2-2-140HA03-HP358	30801225
10,80	12	102	55	40	45	SCD600-1080-2-2-140HA03-HP358	30801227
10,90	12	102	55	40	45	SCD600-1090-2-2-140HA03-HP358	30801228
11,00	12	102	55	40	45	SCD600-1100-2-2-140HA03-HP358	30801229
11,10	12	102	55	40	45	SCD600-1110-2-2-140HA03-HP358	30801230
11,20*	12	102	55	40	45	SCD600-1120-2-2-140HA03-HP358	30801231
11,25	12	102	55	40	45	SCD600-1125-2-2-140HA03-HP358	30801232
11,30	12	102	55	40	45	SCD600-1130-2-2-140HA03-HP358	30801233
11,35	12	102	55	40	45	SCD600-1135-2-2-140HA03-HP358	30801234

MEGA-Drill-Steel-Plus | Vollhartmetall-Spiralbohrer SCD600 (3xD), äußere Kühlmittelzufuhr

Baumaße						Schaftform HA	
d ₁ m7	d ₂ h6	l ₁	l ₂	l ₃	l ₄	Spezifikation	Bestell-Nr.
11,40	12	102	55	40	45	SCD600-1140-2-2-140HA03-HP358	30801235
11,50	12	102	55	40	45	SCD600-1150-2-2-140HA03-HP358	30801237
11,60	12	102	55	40	45	SCD600-1160-2-2-140HA03-HP358	30801238
11,70	12	102	55	40	45	SCD600-1170-2-2-140HA03-HP358	30801239
11,80	12	102	55	40	45	SCD600-1180-2-2-140HA03-HP358	30801240
11,90	12	102	55	40	45	SCD600-1190-2-2-140HA03-HP358	30801241
12,00	12	102	55	40	45	SCD600-1200-2-2-140HA03-HP358	30801242
12,15	14	107	60	43	45	SCD600-1215-2-2-140HA03-HP358	30801243
12,25	14	107	60	43	45	SCD600-1225-2-2-140HA03-HP358	30801244
12,50	14	107	60	43	45	SCD600-1250-2-2-140HA03-HP358	30801245
12,55	14	107	60	43	45	SCD600-1255-2-2-140HA03-HP358	30801246
12,70	14	107	60	43	45	SCD600-1270-2-2-140HA03-HP358	30801247
12,80	14	107	60	43	45	SCD600-1280-2-2-140HA03-HP358	30801248
13,00	14	107	60	43	45	SCD600-1300-2-2-140HA03-HP358	30801250
13,10	14	107	60	43	45	SCD600-1310-2-2-140HA03-HP358	30801251
13,30	14	107	60	43	45	SCD600-1330-2-2-140HA03-HP358	30801252
13,35	14	107	60	43	45	SCD600-1335-2-2-140HA03-HP358	30801253
13,50	14	107	60	43	45	SCD600-1350-2-2-140HA03-HP358	30801254
13,70	14	107	60	43	45	SCD600-1370-2-2-140HA03-HP358	30801255
13,80	14	107	60	43	45	SCD600-1380-2-2-140HA03-HP358	30801256
14,00	14	107	60	43	45	SCD600-1400-2-2-140HA03-HP358	30801257
14,20	16	115	65	45	48	SCD600-1420-2-2-140HA03-HP358	30801258
14,50	16	115	65	45	48	SCD600-1450-2-2-140HA03-HP358	30801259
14,80	16	115	65	45	48	SCD600-1480-2-2-140HA03-HP358	30801260
15,00	16	115	65	45	48	SCD600-1500-2-2-140HA03-HP358	30801261
15,10	16	115	65	45	48	SCD600-1510-2-2-140HA03-HP358	30801262
15,25	16	115	65	45	48	SCD600-1525-2-2-140HA03-HP358	30801263
15,30	16	115	65	45	48	SCD600-1530-2-2-140HA03-HP358	30801264
15,35	16	115	65	45	48	SCD600-1535-2-2-140HA03-HP358	30801265
15,50	16	115	65	45	48	SCD600-1550-2-2-140HA03-HP358	30801266
15,60	16	115	65	45	48	SCD600-1560-2-2-140HA03-HP358	30801267
15,80	16	115	65	45	48	SCD600-1580-2-2-140HA03-HP358	30801268
16,00	16	115	65	45	48	SCD600-1600-2-2-140HA03-HP358	30801269
16,05	18	123	73	51	48	SCD600-1605-2-2-140HA03-HP358	30801270
16,50	18	123	73	51	48	SCD600-1650-2-2-140HA03-HP358	30801271
16,80	18	123	73	51	48	SCD600-1680-2-2-140HA03-HP358	30801272
17,00	18	123	73	51	48	SCD600-1700-2-2-140HA03-HP358	30801274
17,50	18	123	73	51	48	SCD600-1750-2-2-140HA03-HP358	30801275
17,80	18	123	73	51	48	SCD600-1780-2-2-140HA03-HP358	30801277
18,00	18	123	73	51	48	SCD600-1800-2-2-140HA03-HP358	30801278
18,50	20	131	79	55	50	SCD600-1850-2-2-140HA03-HP358	30801279
19,00	20	131	79	55	50	SCD600-1900-2-2-140HA03-HP358	30801282
19,35	20	131	79	55	50	SCD600-1935-2-2-140HA03-HP358	30801283
19,60	20	131	79	55	50	SCD600-1960-2-2-140HA03-HP358	30801285
19,80	20	131	79	55	50	SCD600-1980-2-2-140HA03-HP358	30801286
20,00	20	131	79	55	50	SCD600-2000-2-2-140HA03-HP358	30801287

Fortsetzung auf nächster Seite.

MEGA-Drill-Steel-Plus | Vollhartmetall-Spiralbohrer SCD600 (3xD), äußere Kühlmittelzufuhr

Konfigurierbare Merkmale



Durchmesser:
Durchmesser in Abstufungen
von 0,01 mm frei wählbar



Schaftform:
Schaftform: HB | HE

Spezifikation:

SCD600-[Durchmesser]-3-3-140[Schaftform]03-HP358

Beispiel:

SCD600-0431-3-3-140HE03-HP358

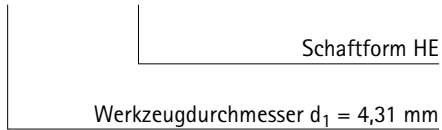

Abmessungen konfigurierbare Baureihe

d ₁ min.	d ₁ max.	d ₂ h6	l ₁	l ₂	l ₃	l ₄
3,00	3,70	6	62	20	14	36
3,71	4,70	6	66	24	17	36
4,71	6,00	6	66	28	20	36
6,01	7,00	8	79	34	24	36
7,01	8,00	8	79	41	29	36
8,01	10,00	10	89	47	35	40
10,01	12,00	12	102	55	40	45
12,01	14,00	14	107	60	43	45
14,01	16,00	16	115	65	45	48
16,01	18,00	18	123	73	51	48
18,01	20,00	20	131	79	55	50

Maßangaben in mm.

* Speziell zur Vorfertigung der Kernlöcher für Gewindeformer geeignet.

Schnittwertempfehlung siehe Kapitelende.

Sonderausführungen und andere Beschichtungen auf Anfrage.

MEGA-Drill-Steel-Plus

Vollhartmetall-Spiralbohrer

SCD601 (3xD), innere Kühlmittelzufuhr, Nachfolgeprodukt des MEGA-Drill-Steel (SCD10)

Ausführung:

Bohrerdurchmesser: 3,00 – 25,00 mm
 Bohrungstoleranz: ≥ IT 9
 Schneidstoff: HP358
 Schneidanzahl: 2
 Anzahl Führungsfasen: 2
 Spitzenwinkel: 140°
 Spiralwinkel: 30°

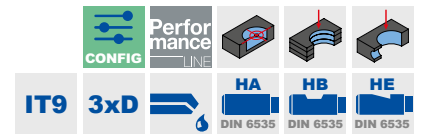
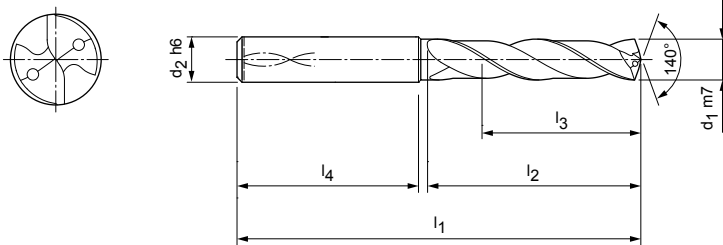

Lagerhaltige Vorzugsbaureihe in Schaftform HA

Baumaße						Schaftform HA	
d ₁ m7	d ₂ h6	l ₁	l ₂	l ₃	l ₄	Spezifikation	Bestell-Nr.
3,00	6	62	20	14	36	SCD601-0300-2-2-140HA03-HP358	30802107
3,10	6	62	20	14	36	SCD601-0310-2-2-140HA03-HP358	30802108
3,15	6	62	20	14	36	SCD601-0315-2-2-140HA03-HP358	30802109
3,20	6	62	20	14	36	SCD601-0320-2-2-140HA03-HP358	30802110
3,22	6	62	20	14	36	SCD601-0322-2-2-140HA03-HP358	30802111
3,25	6	62	20	14	36	SCD601-0325-2-2-140HA03-HP358	30802112
3,30	6	62	20	14	36	SCD601-0330-2-2-140HA03-HP358	30802113
3,40	6	62	20	14	36	SCD601-0340-2-2-140HA03-HP358	30802115
3,50	6	62	20	14	36	SCD601-0350-2-2-140HA03-HP358	30802116
3,60	6	62	20	14	36	SCD601-0360-2-2-140HA03-HP358	30802117
3,70*	6	62	20	14	36	SCD601-0370-2-2-140HA03-HP358	30802118
3,80	6	66	24	17	36	SCD601-0380-2-2-140HA03-HP358	30802119
3,85	6	66	24	17	36	SCD601-0385-2-2-140HA03-HP358	30802120
3,90	6	66	24	17	36	SCD601-0390-2-2-140HA03-HP358	30802121
4,00	6	66	24	17	36	SCD601-0400-2-2-140HA03-HP358	30802122
4,10	6	66	24	17	36	SCD601-0410-2-2-140HA03-HP358	30802123
4,20	6	66	24	17	36	SCD601-0420-2-2-140HA03-HP358	30802124
4,25	6	66	24	17	36	SCD601-0425-2-2-140HA03-HP358	30802125
4,30	6	66	24	17	36	SCD601-0430-2-2-140HA03-HP358	30802126
4,40	6	66	24	17	36	SCD601-0440-2-2-140HA03-HP358	30802129
4,50	6	66	24	17	36	SCD601-0450-2-2-140HA03-HP358	30802131
4,60	6	66	24	17	36	SCD601-0460-2-2-140HA03-HP358	30802132
4,65*	6	66	24	17	36	SCD601-0465-2-2-140HA03-HP358	30802133
4,70	6	66	24	17	36	SCD601-0470-2-2-140HA03-HP358	30802134
4,80	6	66	28	20	36	SCD601-0480-2-2-140HA03-HP358	30802135
4,90	6	66	28	20	36	SCD601-0490-2-2-140HA03-HP358	30802136
4,95	6	66	28	20	36	SCD601-0495-2-2-140HA03-HP358	30802137
5,00	6	66	28	20	36	SCD601-0500-2-2-140HA03-HP358	30802138
5,05	6	66	28	20	36	SCD601-0505-2-2-140HA03-HP358	30802139
5,10	6	66	28	20	36	SCD601-0510-2-2-140HA03-HP358	30802140
5,20	6	66	28	20	36	SCD601-0520-2-2-140HA03-HP358	30802141
5,30	6	66	28	20	36	SCD601-0530-2-2-140HA03-HP358	30802142
5,40	6	66	28	20	36	SCD601-0540-2-2-140HA03-HP358	30802143
5,50	6	66	28	20	36	SCD601-0550-2-2-140HA03-HP358	30802144
5,55*	6	66	28	20	36	SCD601-0555-2-2-140HA03-HP358	30802145

Fortsetzung auf nächster Seite.

MEGA-Drill-Steel-Plus | Vollhartmetall-Spiralbohrer SCD601 (3xD), innere Kühlmittelzufuhr

Baumaße						Schaftform HA	
d ₁ m7	d ₂ h6	l ₁	l ₂	l ₃	l ₄	Spezifikation	Bestell-Nr.
5,60	6	66	28	20	36	SCD601-0560-2-2-140HA03-HP358	30802146
5,70	6	66	28	20	36	SCD601-0570-2-2-140HA03-HP358	30802147
5,75	6	66	28	20	36	SCD601-0575-2-2-140HA03-HP358	30802148
5,80	6	66	28	20	36	SCD601-0580-2-2-140HA03-HP358	30802149
5,90	6	66	28	20	36	SCD601-0590-2-2-140HA03-HP358	30802150
5,95	6	66	28	20	36	SCD601-0595-2-2-140HA03-HP358	30802151
6,00	6	66	28	20	36	SCD601-0600-2-2-140HA03-HP358	30802152
6,10	8	79	34	24	36	SCD601-0610-2-2-140HA03-HP358	30802153
6,20	8	79	34	24	36	SCD601-0620-2-2-140HA03-HP358	30802154
6,30	8	79	34	24	36	SCD601-0630-2-2-140HA03-HP358	30802155
6,40	8	79	34	24	36	SCD601-0640-2-2-140HA03-HP358	30802156
6,50	8	79	34	24	36	SCD601-0650-2-2-140HA03-HP358	30802157
6,60	8	79	34	24	36	SCD601-0660-2-2-140HA03-HP358	30802158
6,70	8	79	34	24	36	SCD601-0670-2-2-140HA03-HP358	30802159
6,80	8	79	34	24	36	SCD601-0680-2-2-140HA03-HP358	30802160
6,90	8	79	34	24	36	SCD601-0690-2-2-140HA03-HP358	30802161
7,00	8	79	34	24	36	SCD601-0700-2-2-140HA03-HP358	30802162
7,10	8	79	41	29	36	SCD601-0710-2-2-140HA03-HP358	30802163
7,20	8	79	41	29	36	SCD601-0720-2-2-140HA03-HP358	30802164
7,30	8	79	41	29	36	SCD601-0730-2-2-140HA03-HP358	30802165
7,40	8	79	41	29	36	SCD601-0740-2-2-140HA03-HP358	30802166
7,45*	8	79	41	29	36	SCD601-0745-2-2-140HA03-HP358	30802167
7,50	8	79	41	29	36	SCD601-0750-2-2-140HA03-HP358	30802168
7,60	8	79	41	29	36	SCD601-0760-2-2-140HA03-HP358	30802169
7,70	8	79	41	29	36	SCD601-0770-2-2-140HA03-HP358	30802170
7,80	8	79	41	29	36	SCD601-0780-2-2-140HA03-HP358	30802171
7,90	8	79	41	29	36	SCD601-0790-2-2-140HA03-HP358	30802172
8,00	8	79	41	29	36	SCD601-0800-2-2-140HA03-HP358	30802173
8,10	10	89	47	35	40	SCD601-0810-2-2-140HA03-HP358	30802174
8,20	10	89	47	35	40	SCD601-0820-2-2-140HA03-HP358	30802175
8,30	10	89	47	35	40	SCD601-0830-2-2-140HA03-HP358	30802176
8,40	10	89	47	35	40	SCD601-0840-2-2-140HA03-HP358	30802177
8,50	10	89	47	35	40	SCD601-0850-2-2-140HA03-HP358	30802178
8,60	10	89	47	35	40	SCD601-0860-2-2-140HA03-HP358	30802179
8,70	10	89	47	35	40	SCD601-0870-2-2-140HA03-HP358	30802180
8,80	10	89	47	35	40	SCD601-0880-2-2-140HA03-HP358	30802181
8,90	10	89	47	35	40	SCD601-0890-2-2-140HA03-HP358	30802182
9,00	10	89	47	35	40	SCD601-0900-2-2-140HA03-HP358	30802183
9,10	10	89	47	35	40	SCD601-0910-2-2-140HA03-HP358	30802184
9,20	10	89	47	35	40	SCD601-0920-2-2-140HA03-HP358	30802185
9,30*	10	89	47	35	40	SCD601-0930-2-2-140HA03-HP358	30802186
9,35	10	89	47	35	40	SCD601-0935-2-2-140HA03-HP358	30802187
9,40	10	89	47	35	40	SCD601-0940-2-2-140HA03-HP358	30802188
9,50	10	89	47	35	40	SCD601-0950-2-2-140HA03-HP358	30802190
9,60	10	89	47	35	40	SCD601-0960-2-2-140HA03-HP358	30802191
9,70	10	89	47	35	40	SCD601-0970-2-2-140HA03-HP358	30802192
9,80	10	89	47	35	40	SCD601-0980-2-2-140HA03-HP358	30802193
9,90	10	89	47	35	40	SCD601-0990-2-2-140HA03-HP358	30802194
10,00	10	89	47	35	40	SCD601-1000-2-2-140HA03-HP358	30802195
10,10	12	102	55	40	45	SCD601-1010-2-2-140HA03-HP358	30802196
10,20	12	102	55	40	45	SCD601-1020-2-2-140HA03-HP358	30802197
10,30	12	102	55	40	45	SCD601-1030-2-2-140HA03-HP358	30802198
10,40	12	102	55	40	45	SCD601-1040-2-2-140HA03-HP358	30802199
10,50	12	102	55	40	45	SCD601-1050-2-2-140HA03-HP358	30802200
10,55	12	102	55	40	45	SCD601-1055-2-2-140HA03-HP358	30802201
10,60	12	102	55	40	45	SCD601-1060-2-2-140HA03-HP358	30802202
10,70	12	102	55	40	45	SCD601-1070-2-2-140HA03-HP358	30802203

MEGA-Drill-Steel-Plus | Vollhartmetall-Spiralbohrer SCD601 (3xD), innere Kühlmittelzufuhr

Baumaße						Schaftform HA	
d ₁ m7	d ₂ h6	l ₁	l ₂	l ₃	l ₄	Spezifikation	Bestell-Nr.
10,75	12	102	55	40	45	SCD601-1075-2-2-140HA03-HP358	30802204
10,80	12	102	55	40	45	SCD601-1080-2-2-140HA03-HP358	30802205
10,90	12	102	55	40	45	SCD601-1090-2-2-140HA03-HP358	30802206
11,00	12	102	55	40	45	SCD601-1100-2-2-140HA03-HP358	30802207
11,10	12	102	55	40	45	SCD601-1110-2-2-140HA03-HP358	30802208
11,20*	12	102	55	40	45	SCD601-1120-2-2-140HA03-HP358	30802209
11,25	12	102	55	40	45	SCD601-1125-2-2-140HA03-HP358	30802210
11,30	12	102	55	40	45	SCD601-1130-2-2-140HA03-HP358	30802211
11,45	12	102	55	40	45	SCD601-1145-2-2-140HA03-HP358	30802214
11,50	12	102	55	40	45	SCD601-1150-2-2-140HA03-HP358	30802215
11,60	12	102	55	40	45	SCD601-1160-2-2-140HA03-HP358	30802216
11,70	12	102	55	40	45	SCD601-1170-2-2-140HA03-HP358	30802217
11,80	12	102	55	40	45	SCD601-1180-2-2-140HA03-HP358	30802218
11,90	12	102	55	40	45	SCD601-1190-2-2-140HA03-HP358	30802219
12,00	12	102	55	40	45	SCD601-1200-2-2-140HA03-HP358	30802220
12,15	14	107	60	43	45	SCD601-1215-2-2-140HA03-HP358	30802221
12,20	14	107	60	43	45	SCD601-1220-2-2-140HA03-HP358	31307544
12,25	14	107	60	43	45	SCD601-1225-2-2-140HA03-HP358	30802222
12,50	14	107	60	43	45	SCD601-1250-2-2-140HA03-HP358	30802223
12,55	14	107	60	43	45	SCD601-1255-2-2-140HA03-HP358	30802224
12,70	14	107	60	43	45	SCD601-1270-2-2-140HA03-HP358	30802225
12,80	14	107	60	43	45	SCD601-1280-2-2-140HA03-HP358	30802226
12,90	14	107	60	43	45	SCD601-1290-2-2-140HA03-HP358	30802227
13,00	14	107	60	43	45	SCD601-1300-2-2-140HA03-HP358	30802228
13,10	14	107	60	43	45	SCD601-1310-2-2-140HA03-HP358	30802229
13,30	14	107	60	43	45	SCD601-1330-2-2-140HA03-HP358	30802230
13,35	14	107	60	43	45	SCD601-1335-2-2-140HA03-HP358	30802231
13,50	14	107	60	43	45	SCD601-1350-2-2-140HA03-HP358	30802232
13,70	14	107	60	43	45	SCD601-1370-2-2-140HA03-HP358	30802233
13,80	14	107	60	43	45	SCD601-1380-2-2-140HA03-HP358	30802234
14,00	14	107	60	43	45	SCD601-1400-2-2-140HA03-HP358	30802235
14,20	16	115	65	45	48	SCD601-1420-2-2-140HA03-HP358	30802236
14,50	16	115	65	45	48	SCD601-1450-2-2-140HA03-HP358	30802237
14,80	16	115	65	45	48	SCD601-1480-2-2-140HA03-HP358	30802238
15,00	16	115	65	45	48	SCD601-1500-2-2-140HA03-HP358	30802239
15,10	16	115	65	45	48	SCD601-1510-2-2-140HA03-HP358	30802240
15,25	16	115	65	45	48	SCD601-1525-2-2-140HA03-HP358	30802241
15,30	16	115	65	45	48	SCD601-1530-2-2-140HA03-HP358	30802242
15,35	16	115	65	45	48	SCD601-1535-2-2-140HA03-HP358	30802243
15,50	16	115	65	45	48	SCD601-1550-2-2-140HA03-HP358	30802244
15,60	16	115	65	45	48	SCD601-1560-2-2-140HA03-HP358	30802245
15,80	16	115	65	45	48	SCD601-1580-2-2-140HA03-HP358	30802246
16,00	16	115	65	45	48	SCD601-1600-2-2-140HA03-HP358	30802247
16,05	18	123	73	51	48	SCD601-1605-2-2-140HA03-HP358	30802248
16,50	18	123	73	51	48	SCD601-1650-2-2-140HA03-HP358	30802249
16,60	18	123	73	51	48	SCD601-1660-2-2-140HA03-HP358	31307545
16,90	18	123	73	51	48	SCD601-1690-2-2-140HA03-HP358	30802251
17,00	18	123	73	51	48	SCD601-1700-2-2-140HA03-HP358	30802252
17,50	18	123	73	51	48	SCD601-1750-2-2-140HA03-HP358	30802253
17,60	18	123	73	51	48	SCD601-1760-2-2-140HA03-HP358	30802254
17,80	18	123	73	51	48	SCD601-1780-2-2-140HA03-HP358	30802255
18,00	18	123	73	51	48	SCD601-1800-2-2-140HA03-HP358	30802256
18,50	20	131	79	55	50	SCD601-1850-2-2-140HA03-HP358	30802257
18,90	20	131	79	55	50	SCD601-1890-2-2-140HA03-HP358	30802259
19,00	20	131	79	55	50	SCD601-1900-2-2-140HA03-HP358	30802260
19,35	20	131	79	55	50	SCD601-1935-2-2-140HA03-HP358	30802261
19,50	20	131	79	55	50	SCD601-1950-2-2-140HA03-HP358	30802262

Fortsetzung auf nächster Seite.

MEGA-Drill-Steel-Plus | Vollhartmetall-Spiralbohrer SCD601 (3xD), innere Kühlmittelzufuhr

Baumaße						Schaftform HA	
d ₁ m7	d ₂ h6	l ₁	l ₂	l ₃	l ₄	Spezifikation	Bestell-Nr.
19,80	20	131	79	55	50	SCD601-1980-2-2-140HA03-HP358	30802264
20,00	20	131	79	55	50	SCD601-2000-2-2-140HA03-HP358	30802265
21,00	25	151	93	66	56	SCD601-2100-2-2-140HA03-HP358	30802267
21,50	25	151	93	66	56	SCD601-2150-2-2-140HA03-HP358	30802268
22,00	25	151	93	66	56	SCD601-2200-2-2-140HA03-HP358	30802269
23,50	25	151	93	66	56	SCD601-2350-2-2-140HA03-HP358	30802272

Konfigurierbare Merkmale



Durchmesser:
Durchmesser in Abstufungen
von 0,01 mm frei wählbar



Schaftform:
Schaftform: HB | HE

Spezifikation:

SCD601-[Durchmesser]-3-3-140[Schaftform]03-HP358

Beispiel:

SCD601-0431-3-3-140HE03-HP358

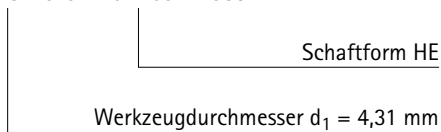

Abmessungen konfigurierbare Baureihe

d ₁ min.	d ₁ max.	d ₂ h6	l ₁	l ₂	l ₃	l ₄
3,00	3,70	6	62	20	14	36
3,71	4,70	6	66	24	17	36
4,71	6,00	6	66	28	20	36
6,01	7,00	8	79	34	24	36
7,01	8,00	8	79	41	29	36
8,01	10,00	10	89	47	35	40
10,01	12,00	12	102	55	40	45
12,01	14,00	14	107	60	43	45
14,01	16,00	16	115	65	45	48
16,01	18,00	18	123	73	51	48
18,01	20,00	20	131	79	55	50
20,01	25,00	25	151	93	66	56

Maßangaben in mm.

* Speziell zur Vorfertigung der Kernlöcher für Gewindeformer geeignet.

Schnittwertempfehlung siehe Kapitelende.

Sonderausführungen und andere Beschichtungen auf Anfrage.

MEGA-Drill-Steel-Plus

Vollhartmetall-Spiralbohrer

SCD600 (5xD), äußere Kühlmittelzufuhr, Nachfolgeprodukt des MEGA-Drill-Steel (SCD10)

Ausführung:

Bohrerdurchmesser:	3,00 – 20,00 mm
Bohrungstoleranz:	≥ IT 9
Schneidstoff:	HP358
Schneidenanzahl:	2
Anzahl Führungsfasen:	2
Spitzenwinkel:	140°
Spiralwinkel:	30°

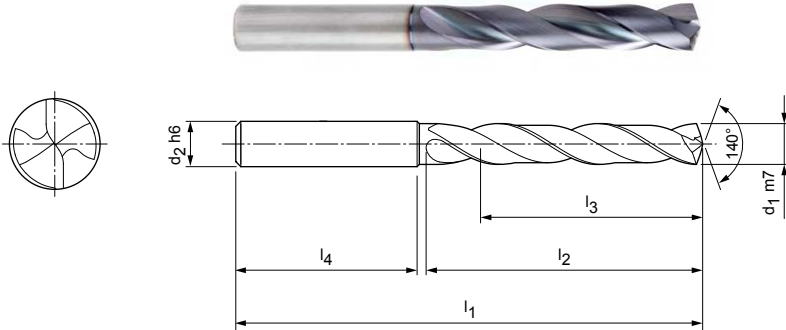

Lagerhaltige Vorzugsbaureihe in Schaftform HA

Baumaße						Schaftform HA	
d ₁ m7	d ₂ h6	l ₁	l ₂	l ₃	l ₄	Spezifikation	Bestell-Nr.
3,00	6	66	28	23	36	SCD600-0300-2-2-140HA05-HP358	30801634
3,10	6	66	28	23	36	SCD600-0310-2-2-140HA05-HP358	30801635
3,15	6	66	28	23	36	SCD600-0315-2-2-140HA05-HP358	30801636
3,20	6	66	28	23	36	SCD600-0320-2-2-140HA05-HP358	30801637
3,25	6	66	28	23	36	SCD600-0325-2-2-140HA05-HP358	30801639
3,30	6	66	28	23	36	SCD600-0330-2-2-140HA05-HP358	30801640
3,40	6	66	28	23	36	SCD600-0340-2-2-140HA05-HP358	30801641
3,50	6	66	28	23	36	SCD600-0350-2-2-140HA05-HP358	30801642
3,60	6	66	28	23	36	SCD600-0360-2-2-140HA05-HP358	30801643
3,70	6	66	28	23	36	SCD600-0370-2-2-140HA05-HP358	30801644
3,80	6	74	36	29	36	SCD600-0380-2-2-140HA05-HP358	30801645
3,90	6	74	36	29	36	SCD600-0390-2-2-140HA05-HP358	30801647
4,00	6	74	36	29	36	SCD600-0400-2-2-140HA05-HP358	30801648
4,10	6	74	36	29	36	SCD600-0410-2-2-140HA05-HP358	30801649
4,20	6	74	36	29	36	SCD600-0420-2-2-140HA05-HP358	30801650
4,25	6	74	36	29	36	SCD600-0425-2-2-140HA05-HP358	30801651
4,30	6	74	36	29	36	SCD600-0430-2-2-140HA05-HP358	30801652
4,35	6	74	36	29	36	SCD600-0435-2-2-140HA05-HP358	30801653
4,40	6	74	36	29	36	SCD600-0440-2-2-140HA05-HP358	30801654
4,50	6	74	36	29	36	SCD600-0450-2-2-140HA05-HP358	30801656
4,60	6	74	36	29	36	SCD600-0460-2-2-140HA05-HP358	30801657
4,65	6	74	36	29	36	SCD600-0465-2-2-140HA05-HP358	30801658
4,70	6	74	36	29	36	SCD600-0470-2-2-140HA05-HP358	30801659
4,80	6	82	44	35	36	SCD600-0480-2-2-140HA05-HP358	30801660
4,90	6	82	44	35	36	SCD600-0490-2-2-140HA05-HP358	30801662
4,95	6	82	44	35	36	SCD600-0495-2-2-140HA05-HP358	30801663
5,00	6	82	44	35	36	SCD600-0500-2-2-140HA05-HP358	30801664
5,05	6	82	44	35	36	SCD600-0505-2-2-140HA05-HP358	30801665
5,10	6	82	44	35	36	SCD600-0510-2-2-140HA05-HP358	30801666
5,20	6	82	44	35	36	SCD600-0520-2-2-140HA05-HP358	30801667
5,30	6	82	44	35	36	SCD600-0530-2-2-140HA05-HP358	30801668
5,40	6	82	44	35	36	SCD600-0540-2-2-140HA05-HP358	30801669
5,50	6	82	44	35	36	SCD600-0550-2-2-140HA05-HP358	30801670
5,55	6	82	44	35	36	SCD600-0555-2-2-140HA05-HP358	30801671
5,60	6	82	44	35	36	SCD600-0560-2-2-140HA05-HP358	30801672

Fortsetzung auf nächster Seite.

MEGA-Drill-Steel-Plus | Vollhartmetall-Spiralbohrer SCD600 (5xD), äußere Kühlmittelzufuhr

Baumaße						Schaftform HA	
d ₁ m7	d ₂ h6	l ₁	l ₂	l ₃	l ₄	Spezifikation	Bestell-Nr.
5,70	6	82	44	35	36	SCD600-0570-2-2-140HA05-HP358	30801673
5,75	6	82	44	35	36	SCD600-0575-2-2-140HA05-HP358	30801674
5,80	6	82	44	35	36	SCD600-0580-2-2-140HA05-HP358	30801675
5,90	6	82	44	35	36	SCD600-0590-2-2-140HA05-HP358	30801676
5,95	6	82	44	35	36	SCD600-0595-2-2-140HA05-HP358	30801677
6,00	6	82	44	35	36	SCD600-0600-2-2-140HA05-HP358	30801678
6,10	8	91	53	43	36	SCD600-0610-2-2-140HA05-HP358	30801679
6,20	8	91	53	43	36	SCD600-0620-2-2-140HA05-HP358	30801680
6,30	8	91	53	43	36	SCD600-0630-2-2-140HA05-HP358	30801681
6,40	8	91	53	43	36	SCD600-0640-2-2-140HA05-HP358	30801682
6,50	8	91	53	43	36	SCD600-0650-2-2-140HA05-HP358	30801683
6,60	8	91	53	43	36	SCD600-0660-2-2-140HA05-HP358	30801684
6,70	8	91	53	43	36	SCD600-0670-2-2-140HA05-HP358	30801685
6,80	8	91	53	43	36	SCD600-0680-2-2-140HA05-HP358	30801686
6,90	8	91	53	43	36	SCD600-0690-2-2-140HA05-HP358	30801687
7,00	8	91	53	43	36	SCD600-0700-2-2-140HA05-HP358	30801688
7,10	8	91	53	43	36	SCD600-0710-2-2-140HA05-HP358	30801689
7,20	8	91	53	43	36	SCD600-0720-2-2-140HA05-HP358	30801690
7,30	8	91	53	43	36	SCD600-0730-2-2-140HA05-HP358	30801691
7,40	8	91	53	43	36	SCD600-0740-2-2-140HA05-HP358	30801692
7,45	8	91	53	43	36	SCD600-0745-2-2-140HA05-HP358	30801693
7,50	8	91	53	43	36	SCD600-0750-2-2-140HA05-HP358	30801694
7,60	8	91	53	43	36	SCD600-0760-2-2-140HA05-HP358	30801695
7,80	8	91	53	43	36	SCD600-0780-2-2-140HA05-HP358	30801697
7,90	8	91	53	43	36	SCD600-0790-2-2-140HA05-HP358	30801698
8,00	8	91	53	43	36	SCD600-0800-2-2-140HA05-HP358	30801699
8,10	10	103	61	49	40	SCD600-0810-2-2-140HA05-HP358	30801700
8,20	10	103	61	49	40	SCD600-0820-2-2-140HA05-HP358	30801701
8,30	10	103	61	49	40	SCD600-0830-2-2-140HA05-HP358	30801702
8,40	10	103	61	49	40	SCD600-0840-2-2-140HA05-HP358	30801703
8,50	10	103	61	49	40	SCD600-0850-2-2-140HA05-HP358	30801704
8,60	10	103	61	49	40	SCD600-0860-2-2-140HA05-HP358	30801705
8,70	10	103	61	49	40	SCD600-0870-2-2-140HA05-HP358	30801706
8,80	10	103	61	49	40	SCD600-0880-2-2-140HA05-HP358	30801707
8,90	10	103	61	49	40	SCD600-0890-2-2-140HA05-HP358	30801708
9,00	10	103	61	49	40	SCD600-0900-2-2-140HA05-HP358	30801709
9,10	10	103	61	49	40	SCD600-0910-2-2-140HA05-HP358	30801710
9,20	10	103	61	49	40	SCD600-0920-2-2-140HA05-HP358	30801711
9,30	10	103	61	49	40	SCD600-0930-2-2-140HA05-HP358	30801712
9,50	10	103	61	49	40	SCD600-0950-2-2-140HA05-HP358	30801716
9,60	10	103	61	49	40	SCD600-0960-2-2-140HA05-HP358	30801717
9,70	10	103	61	49	40	SCD600-0970-2-2-140HA05-HP358	30801718
9,80	10	103	61	49	40	SCD600-0980-2-2-140HA05-HP358	30801719
9,90	10	103	61	49	40	SCD600-0990-2-2-140HA05-HP358	30801720
10,00	10	103	61	49	40	SCD600-1000-2-2-140HA05-HP358	30801721
10,10	12	118	71	56	45	SCD600-1010-2-2-140HA05-HP358	30801722
10,20	12	118	71	56	45	SCD600-1020-2-2-140HA05-HP358	30801723
10,30	12	118	71	56	45	SCD600-1030-2-2-140HA05-HP358	30801724
10,40	12	118	71	56	45	SCD600-1040-2-2-140HA05-HP358	30801725
10,50	12	118	71	56	45	SCD600-1050-2-2-140HA05-HP358	30801726
10,70	12	118	71	56	45	SCD600-1070-2-2-140HA05-HP358	30801729
10,75	12	118	71	56	45	SCD600-1075-2-2-140HA05-HP358	30801731
10,80	12	118	71	56	45	SCD600-1080-2-2-140HA05-HP358	30801732
11,00	12	118	71	56	45	SCD600-1100-2-2-140HA05-HP358	30801734
11,20	12	118	71	56	45	SCD600-1120-2-2-140HA05-HP358	30801736
11,25	12	118	71	56	45	SCD600-1125-2-2-140HA05-HP358	30801737
11,30	12	118	71	56	45	SCD600-1130-2-2-140HA05-HP358	30801738

MEGA-Drill-Steel-Plus | Vollhartmetall-Spiralbohrer SCD600 (5xD), äußere Kühlmittelzufuhr

Baumaße						Schaftform HA	
d ₁ m7	d ₂ h6	l ₁	l ₂	l ₃	l ₄	Spezifikation	Bestell-Nr.
11,35	12	118	71	56	45	SCD600-1135-2-2-140HA05-HP358	30801739
11,50	12	118	71	56	45	SCD600-1150-2-2-140HA05-HP358	30801742
11,80	12	118	71	56	45	SCD600-1180-2-2-140HA05-HP358	30801745
11,90	12	118	71	56	45	SCD600-1190-2-2-140HA05-HP358	30801746
12,00	12	118	71	56	45	SCD600-1200-2-2-140HA05-HP358	30801747
12,15	14	124	77	60	45	SCD600-1215-2-2-140HA05-HP358	30801748
12,25	14	124	77	60	45	SCD600-1225-2-2-140HA05-HP358	30801749
12,50	14	124	77	60	45	SCD600-1250-2-2-140HA05-HP358	30801750
12,70	14	124	77	60	45	SCD600-1270-2-2-140HA05-HP358	30801752
12,80	14	124	77	60	45	SCD600-1280-2-2-140HA05-HP358	30801753
12,90	14	124	77	60	45	SCD600-1290-2-2-140HA05-HP358	30801754
13,00	14	124	77	60	45	SCD600-1300-2-2-140HA05-HP358	30801755
13,10	14	124	77	60	45	SCD600-1310-2-2-140HA05-HP358	30801756
13,30	14	124	77	60	45	SCD600-1330-2-2-140HA05-HP358	30801757
13,35	14	124	77	60	45	SCD600-1335-2-2-140HA05-HP358	30801758
13,50	14	124	77	60	45	SCD600-1350-2-2-140HA05-HP358	30801759
13,80	14	124	77	60	45	SCD600-1380-2-2-140HA05-HP358	30801761
14,00	14	124	77	60	45	SCD600-1400-2-2-140HA05-HP358	30801762
14,20	16	133	83	63	48	SCD600-1420-2-2-140HA05-HP358	30801763
14,50	16	133	83	63	48	SCD600-1450-2-2-140HA05-HP358	30801764
14,80	16	133	83	63	48	SCD600-1480-2-2-140HA05-HP358	30801765
15,00	16	133	83	63	48	SCD600-1500-2-2-140HA05-HP358	30801766
15,10	16	133	83	63	48	SCD600-1510-2-2-140HA05-HP358	30801767
15,25	16	133	83	63	48	SCD600-1525-2-2-140HA05-HP358	30801768
15,30	16	133	83	63	48	SCD600-1530-2-2-140HA05-HP358	30801769
15,50	16	133	83	63	48	SCD600-1550-2-2-140HA05-HP358	30801771
15,80	16	133	83	63	48	SCD600-1580-2-2-140HA05-HP358	30801773
16,00	16	133	83	63	48	SCD600-1600-2-2-140HA05-HP358	30801774
16,50	18	143	93	71	48	SCD600-1650-2-2-140HA05-HP358	30801776
16,80	18	143	93	71	48	SCD600-1680-2-2-140HA05-HP358	30801777
17,00	18	143	93	71	48	SCD600-1700-2-2-140HA05-HP358	30801779
17,50	18	143	93	71	48	SCD600-1750-2-2-140HA05-HP358	30801780
17,60	18	143	93	71	48	SCD600-1760-2-2-140HA05-HP358	30801781
18,00	18	143	93	71	48	SCD600-1800-2-2-140HA05-HP358	30801783
18,50	20	153	101	77	50	SCD600-1850-2-2-140HA05-HP358	30801784
18,80	20	153	101	77	50	SCD600-1880-2-2-140HA05-HP358	30801785
18,90	20	153	101	77	50	SCD600-1890-2-2-140HA05-HP358	30801786
19,00	20	153	101	77	50	SCD600-1900-2-2-140HA05-HP358	30801787
19,50	20	153	101	77	50	SCD600-1950-2-2-140HA05-HP358	30801789
19,80	20	153	101	77	50	SCD600-1980-2-2-140HA05-HP358	30801791
20,00	20	153	101	77	50	SCD600-2000-2-2-140HA05-HP358	30801792

Fortsetzung auf nächster Seite.

MEGA-Drill-Steel-Plus | Vollhartmetall-Spiralbohrer SCD600 (5xD), äußere Kühlmittelzufuhr

Konfigurierbare Merkmale



Durchmesser:
Durchmesser in Abstufungen
von 0,01 mm frei wählbar



Schaftform:
Schaftform: HB | HE

Spezifikation:

SCD600-[Durchmesser]-3-3-140[Schaftform]05-HP358

Abmessungen konfigurierbare Baureihe

d ₁ min.	d ₁ max.	d ₂ h6	l ₁	l ₂	l ₃	l ₄
3,00	3,70	6	66	28	23	36
3,71	4,70	6	74	36	29	36
4,71	6,00	6	82	44	35	36
6,01	8,00	8	91	53	43	36
8,01	10,00	10	103	61	49	40
10,01	12,00	12	118	71	56	45
12,01	14,00	14	124	77	60	45
14,01	16,00	16	133	83	63	48
16,01	18,00	18	143	93	71	48
18,01	20,00	20	153	101	77	50

Beispiel:

SCD600-0431-3-3-140HE05-HP358

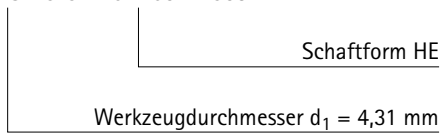

MEGA-Drill-Steel-Plus

Vollhartmetall-Spiralbohrer

SCD601 (5xD), innere Kühlmittelzufuhr, Nachfolgeprodukt des MEGA-Drill-Steel (SCD10)

Ausführung:

Bohrerdurchmesser: 3,00 – 25,00 mm
 Bohrungstoleranz: ≥ IT 9
 Schneidstoff: HP358
 Schneidanzahl: 2
 Anzahl Führungsfasen: 2
 Spitzenwinkel: 140°
 Spiralwinkel: 30°

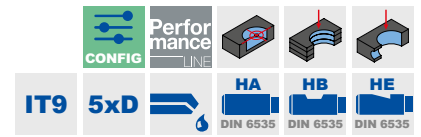
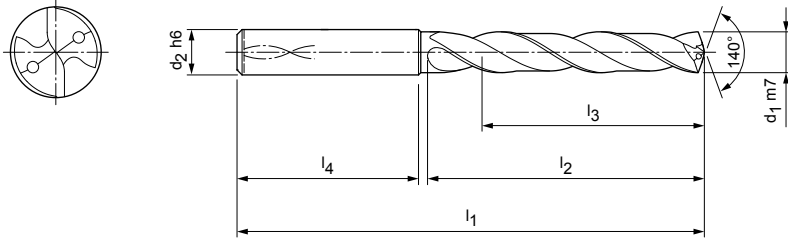

Lagerhaltige Vorzugsbaureihe in Schaftform HA

Baumaße						Schaftform HA	
d ₁ m7	d ₂ h6	l ₁	l ₂	l ₃	l ₄	Spezifikation	Bestell-Nr.
3,00	6	66	28	23	36	SCD601-0300-2-2-140HA05-HP358	30802611
3,10	6	66	28	23	36	SCD601-0310-2-2-140HA05-HP358	30802612
3,15	6	66	28	23	36	SCD601-0315-2-2-140HA05-HP358	30802613
3,20	6	66	28	23	36	SCD601-0320-2-2-140HA05-HP358	30802614
3,25	6	66	28	23	36	SCD601-0325-2-2-140HA05-HP358	30802616
3,30	6	66	28	23	36	SCD601-0330-2-2-140HA05-HP358	30802617
3,40	6	66	28	23	36	SCD601-0340-2-2-140HA05-HP358	30802618
3,50	6	66	28	23	36	SCD601-0350-2-2-140HA05-HP358	30802619
3,60	6	66	28	23	36	SCD601-0360-2-2-140HA05-HP358	30802620
3,65	6	66	28	23	36	SCD601-0365-2-2-140HA05-HP358	31307546
3,70*	6	66	28	23	36	SCD601-0370-2-2-140HA05-HP358	30802621
3,80	6	74	36	29	36	SCD601-0380-2-2-140HA05-HP358	30802622
3,85	6	74	36	29	36	SCD601-0385-2-2-140HA05-HP358	30802623
3,90	6	74	36	29	36	SCD601-0390-2-2-140HA05-HP358	30802624
4,00	6	74	36	29	36	SCD601-0400-2-2-140HA05-HP358	30802625
4,10	6	74	36	29	36	SCD601-0410-2-2-140HA05-HP358	30802626
4,20	6	74	36	29	36	SCD601-0420-2-2-140HA05-HP3583	30802627
4,25	6	74	36	29	36	SCD601-0425-2-2-140HA05-HP358	30802628
4,30	6	74	36	29	36	SCD601-0430-2-2-140HA05-HP358	30802629
4,35	6	74	36	29	36	SCD601-0435-2-2-140HA05-HP358	30802630
4,40	6	74	36	29	36	SCD601-0440-2-2-140HA05-HP358	30802631
4,45	6	74	36	29	36	SCD601-0445-2-2-140HA05-HP358	30802632
4,50	6	74	36	29	36	SCD601-0450-2-2-140HA05-HP358	30802633
4,60	6	74	36	29	36	SCD601-0460-2-2-140HA05-HP358	30802634
4,65*	6	74	36	29	36	SCD601-0465-2-2-140HA05-HP358	30802635
4,70	6	74	36	29	36	SCD601-0470-2-2-140HA05-HP358	30802636
4,80	6	82	44	35	36	SCD601-0480-2-2-140HA05-HP358	30802637
4,90	6	82	44	35	36	SCD601-0490-2-2-140HA05-HP358	30802638
4,95	6	82	44	35	36	SCD601-0495-2-2-140HA05-HP358	30802639
5,00	6	82	44	35	36	SCD601-0500-2-2-140HA05-HP358	30802640
5,05	6	82	44	35	36	SCD601-0505-2-2-140HA05-HP358	30802641
5,10	6	82	44	35	36	SCD601-0510-2-2-140HA05-HP358	30802642
5,20	6	82	44	35	36	SCD601-0520-2-2-140HA05-HP358	30802643
5,30	6	82	44	35	36	SCD601-0530-2-2-140HA05-HP358	30802644
5,40	6	82	44	35	36	SCD601-0540-2-2-140HA05-HP358	30802645

MEGA-Drill-Steel-Plus | Vollhartmetall-Spiralbohrer SCD601 (5xD), innere Kühlmittelzufuhr

Baumaße						Schaftform HA	
d ₁ m7	d ₂ h6	l ₁	l ₂	l ₃	l ₄	Spezifikation	Bestell-Nr.
5,50	6	82	44	35	36	SCD601-0550-2-2-140HA05-HP358	30802646
5,55*	6	82	44	35	36	SCD601-0555-2-2-140HA05-HP358	30802647
5,60	6	82	44	35	36	SCD601-0560-2-2-140HA05-HP358	30802648
5,70	6	82	44	35	36	SCD601-0570-2-2-140HA05-HP358	30802649
5,75	6	82	44	35	36	SCD601-0575-2-2-140HA05-HP358	30802650
5,80	6	82	44	35	36	SCD601-0580-2-2-140HA05-HP358	30802651
5,90	6	82	44	35	36	SCD601-0590-2-2-140HA05-HP358	30802652
5,95	6	82	44	35	36	SCD601-0595-2-2-140HA05-HP358	30802653
6,00	6	82	44	35	36	SCD601-0600-2-2-140HA05-HP358	30802654
6,10	8	91	53	43	36	SCD601-0610-2-2-140HA05-HP358	30802655
6,20	8	91	53	43	36	SCD601-0620-2-2-140HA05-HP358	30802656
6,30	8	91	53	43	36	SCD601-0630-2-2-140HA05-HP358	30802657
6,40	8	91	53	43	36	SCD601-0640-2-2-140HA05-HP358	30802658
6,50	8	91	53	43	36	SCD601-0650-2-2-140HA05-HP358	30802659
6,60	8	91	53	43	36	SCD601-0660-2-2-140HA05-HP358	30802660
6,70	8	91	53	43	36	SCD601-0670-2-2-140HA05-HP358	30802661
6,80	8	91	53	43	36	SCD601-0680-2-2-140HA05-HP358	30802662
6,90	8	91	53	43	36	SCD601-0690-2-2-140HA05-HP358	30802663
7,00	8	91	53	43	36	SCD601-0700-2-2-140HA05-HP358	30802664
7,10	8	91	53	43	36	SCD601-0710-2-2-140HA05-HP358	30802665
7,20	8	91	53	43	36	SCD601-0720-2-2-140HA05-HP358	30802666
7,30	8	91	53	43	36	SCD601-0730-2-2-140HA05-HP358	30802667
7,40	8	91	53	43	36	SCD601-0740-2-2-140HA05-HP358	30802668
7,45*	8	91	53	43	36	SCD601-0745-2-2-140HA05-HP358	30802669
7,50	8	91	53	43	36	SCD601-0750-2-2-140HA05-HP358	30802670
7,60	8	91	53	43	36	SCD601-0760-2-2-140HA05-HP358	30802671
7,70	8	91	53	43	36	SCD601-0770-2-2-140HA05-HP358	30802672
7,80	8	91	53	43	36	SCD601-0780-2-2-140HA05-HP358	30802673
7,90	8	91	53	43	36	SCD601-0790-2-2-140HA05-HP358	30802674
8,00	8	91	53	43	36	SCD601-0800-2-2-140HA05-HP358	30802675
8,10	10	103	61	49	40	SCD601-0810-2-2-140HA05-HP358	30802676
8,20	10	103	61	49	40	SCD601-0820-2-2-140HA05-HP358	30802677
8,30	10	103	61	49	40	SCD601-0830-2-2-140HA05-HP358	30802678
8,40	10	103	61	49	40	SCD601-0840-2-2-140HA05-HP358	30802679
8,50	10	103	61	49	40	SCD601-0850-2-2-140HA05-HP358	30802680
8,60	10	103	61	49	40	SCD601-0860-2-2-140HA05-HP358	30802681
8,70	10	103	61	49	40	SCD601-0870-2-2-140HA05-HP358	30802682
8,80	10	103	61	49	40	SCD601-0880-2-2-140HA05-HP358	30802683
8,90	10	103	61	49	40	SCD601-0890-2-2-140HA05-HP358	30802684
9,00	10	103	61	49	40	SCD601-0900-2-2-140HA05-HP358	30802685
9,10	10	103	61	49	40	SCD601-0910-2-2-140HA05-HP358	30802686
9,20	10	103	61	49	40	SCD601-0920-2-2-140HA05-HP358	30802687
9,30*	10	103	61	49	40	SCD601-0930-2-2-140HA05-HP358	30802688
9,35	10	103	61	49	40	SCD601-0935-2-2-140HA05-HP358	30802689
9,40	10	103	61	49	40	SCD601-0940-2-2-140HA05-HP358	30802690
9,45	10	103	61	49	40	SCD601-0945-2-2-140HA05-HP358	30802691
9,50	10	103	61	49	40	SCD601-0950-2-2-140HA05-HP358	30802692
9,60	10	103	61	49	40	SCD601-0960-2-2-140HA05-HP358	30802693
9,70	10	103	61	49	40	SCD601-0970-2-2-140HA05-HP358	30802694
9,80	10	103	61	49	40	SCD601-0980-2-2-140HA05-HP358	30802695
9,90	10	103	61	49	40	SCD601-0990-2-2-140HA05-HP358	30802696
10,00	10	103	61	49	40	SCD601-1000-2-2-140HA05-HP358	30802697
10,10	12	118	71	56	45	SCD601-1010-2-2-140HA05-HP358	30802698
10,20	12	118	71	56	45	SCD601-1020-2-2-140HA05-HP358	30802699
10,30	12	118	71	56	45	SCD601-1030-2-2-140HA05-HP358	30802700
10,40	12	118	71	56	45	SCD601-1040-2-2-140HA05-HP358	30802701
10,50	12	118	71	56	45	SCD601-1050-2-2-140HA05-HP358	30802702

MEGA-Drill-Steel-Plus | Vollhartmetall-Spiralbohrer SCD601 (5xD), innere Kühlmittelzufuhr

Baumaße						Schaftform HA	
d ₁ m7	d ₂ h6	l ₁	l ₂	l ₃	l ₄	Spezifikation	Bestell-Nr.
10,55	12	118	71	56	45	SCD601-1055-2-2-140HA05-HP358	30802703
10,60	12	118	71	56	45	SCD601-1060-2-2-140HA05-HP358	30802704
10,70	12	118	71	56	45	SCD601-1070-2-2-140HA05-HP358	30802705
10,80	12	118	71	56	45	SCD601-1080-2-2-140HA05-HP358	30802707
10,90	12	118	71	56	45	SCD601-1090-2-2-140HA05-HP358	30802708
11,00	12	118	71	56	45	SCD601-1100-2-2-140HA05-HP358	30802709
11,10	12	118	71	56	45	SCD601-1110-2-2-140HA05-HP358	30802710
11,20*	12	118	71	56	45	SCD601-1120-2-2-140HA05-HP358	30802711
11,25	12	118	71	56	45	SCD601-1125-2-2-140HA05-HP358	30802712
11,30	12	118	71	56	45	SCD601-1130-2-2-140HA05-HP358	30802713
11,40	12	118	71	56	45	SCD601-1140-2-2-140HA05-HP358	30802715
11,50	12	118	71	56	45	SCD601-1150-2-2-140HA05-HP358	30802717
11,60	12	118	71	56	45	SCD601-1160-2-2-140HA05-HP358	30802718
11,70	12	118	71	56	45	SCD601-1170-2-2-140HA05-HP358	30802719
11,80	12	118	71	56	45	SCD601-1180-2-2-140HA05-HP358	30802720
11,90	12	118	71	56	45	SCD601-1190-2-2-140HA05-HP358	30802721
12,00	12	118	71	56	45	SCD601-1200-2-2-140HA05-HP358	30802722
12,15	14	124	77	60	45	SCD601-1215-2-2-140HA05-HP358	30802723
12,25	14	124	77	60	45	SCD601-1225-2-2-140HA05-HP358	30802724
12,30	14	124	77	60	45	SCD601-1230-2-2-140HA05-HP358	31201193
12,50	14	124	77	60	45	SCD601-1250-2-2-140HA05-HP358	30802725
12,55	14	124	77	60	45	SCD601-1255-2-2-140HA05-HP358	30802726
12,70	14	124	77	60	45	SCD601-1270-2-2-140HA05-HP358	30802727
12,80	14	124	77	60	45	SCD601-1280-2-2-140HA05-HP358	30802728
12,90	14	124	77	60	45	SCD601-1290-2-2-140HA05-HP358	30802729
13,00	14	124	77	60	45	SCD601-1300-2-2-140HA05-HP358	30802730
13,10	14	124	77	60	45	SCD601-1310-2-2-140HA05-HP358	30802731
13,30	14	124	77	60	45	SCD601-1330-2-2-140HA05-HP358	30802732
13,35	14	124	77	60	45	SCD601-1335-2-2-140HA05-HP358	30802733
13,50	14	124	77	60	45	SCD601-1350-2-2-140HA05-HP358	30802734
13,70	14	124	77	60	45	SCD601-1370-2-2-140HA05-HP358	30802735
13,80	14	124	77	60	45	SCD601-1380-2-2-140HA05-HP358	30802736
14,00	14	124	77	60	45	SCD601-1400-2-2-140HA05-HP358	30802737
14,20	16	133	83	63	48	SCD601-1420-2-2-140HA05-HP358	30802738
14,50	16	133	83	63	48	SCD601-1450-2-2-140HA05-HP358	30802739
14,80	16	133	83	63	48	SCD601-1480-2-2-140HA05-HP358	30802740
15,00	16	133	83	63	48	SCD601-1500-2-2-140HA05-HP358	30802741
15,10	16	133	83	63	48	SCD601-1510-2-2-140HA05-HP358	30802742
15,25	16	133	83	63	48	SCD601-1525-2-2-140HA05-HP358	30802743
15,30	16	133	83	63	48	SCD601-1530-2-2-140HA05-HP358	30802744
15,35	16	133	83	63	48	SCD601-1535-2-2-140HA05-HP358	30802745
15,50	16	133	83	63	48	SCD601-1550-2-2-140HA05-HP358	30802746
15,60	16	133	83	63	48	SCD601-1560-2-2-140HA05-HP358	30802747
15,80	16	133	83	63	48	SCD601-1580-2-2-140HA05-HP358	30802748
16,00	16	133	83	63	48	SCD601-1600-2-2-140HA05-HP358	30802749
16,05	18	143	93	71	48	SCD601-1605-2-2-140HA05-HP358	30802750
16,50	18	143	93	71	48	SCD601-1650-2-2-140HA05-HP358	30802751
16,80	18	143	93	71	48	SCD601-1680-2-2-140HA05-HP358	30802752
16,90	18	143	93	71	48	SCD601-1690-2-2-140HA05-HP358	30802753
17,00	18	143	93	71	48	SCD601-1700-2-2-140HA05-HP358	30802754

Fortsetzung auf nächster Seite.

MEGA-Drill-Steel-Plus | Vollhartmetall-Spiralbohrer SCD601 (5xD), innere Kühlmittelzufuhr

Konfigurierbare Merkmale



Durchmesser:
Durchmesser in Abstufungen
von 0,01 mm frei wählbar



Schaftform:
Schaftform: HB | HE

Spezifikation:

SCD601-[Durchmesser]-3-3-140[Schaftform]05-HP358

Beispiel:

SCD601-0431-3-3-140HE05-HP358

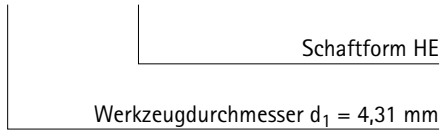

Abmessungen konfigurierbare Baureihe

d ₁ min.	d ₁ max.	d ₂ h6	l ₁	l ₂	l ₃	l ₄
3,00	3,70	6	66	28	23	36
3,71	4,70	6	74	36	29	36
4,71	6,00	6	82	44	35	36
6,01	8,00	8	91	53	43	36
8,01	10,00	10	103	61	49	40
10,01	12,00	12	118	71	56	45
12,01	14,00	14	124	77	60	45
14,01	16,00	16	133	83	63	48
16,01	18,00	18	143	93	71	48
18,01	20,00	20	153	101	77	50
20,01	22,00	25	200	135	110	56
22,01	25,00	25	200	140	120	56

Maßangaben in mm.

* Speziell zur Vorfertigung der Kernlöcher für Gewindeformer geeignet.

Schnittwertempfehlung siehe Kapitelende.

Sonderausführungen und andere Beschichtungen auf Anfrage.

MEGA-Drill-Steel-Plus

Vollhartmetall-Spiralbohrer

SCD601 (8xD), innere Kühlmittelzufuhr, Nachfolgeprodukt des MEGA-Drill-Steel (SCD10)

Ausführung:

Bohrerdurchmesser: 3,00 – 20,00 mm
 Bohrungstoleranz: ≥ IT 9
 Schneidstoff: HP358
 Schneidanzahl: 2
 Anzahl Führungsfasen: 2
 Spitzenwinkel: 135°
 Spiralwinkel: 30°

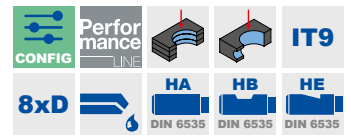
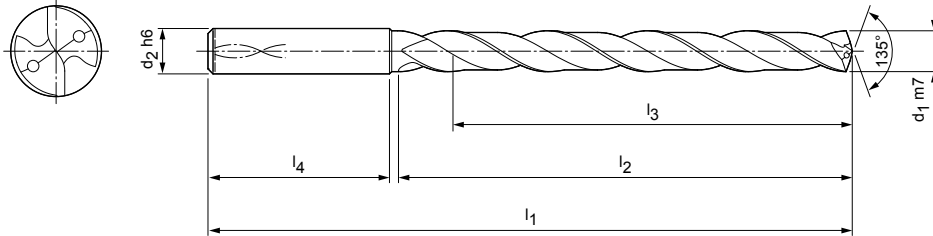

Lagerhaltige Vorzugsbaureihe in Schaftform HA

Baumaße						Schaftform HA	
d ₁ m7	d ₂ h6	l ₁	l ₂	l ₃	l ₄	Spezifikation	Bestell-Nr.
3,00	6	72	34	29	36	SCD601-0300-2-2-140HA08-HP358	30803112
3,10	6	72	34	29	36	SCD601-0310-2-2-140HA08-HP358	30803113
3,20	6	72	34	29	36	SCD601-0320-2-2-140HA08-HP358	30803114
3,30	6	72	34	29	36	SCD601-0330-2-2-140HA08-HP358	30803115
3,40	6	72	34	29	36	SCD601-0340-2-2-140HA08-HP358	30803116
3,50	6	72	34	29	36	SCD601-0350-2-2-140HA08-HP358	30803117
3,60	6	72	34	29	36	SCD601-0360-2-2-140HA08-HP358	30803118
3,70	6	72	34	29	36	SCD601-0370-2-2-140HA08-HP358	30803119
3,80	6	81	43	36	36	SCD601-0380-2-2-140HA08-HP358	30803120
3,90	6	81	43	36	36	SCD601-0390-2-2-140HA08-HP358	30803121
4,00	6	81	43	36	36	SCD601-0400-2-2-140HA08-HP358	30803122
4,10	6	81	43	36	36	SCD601-0410-2-2-140HA08-HP358	30803123
4,20	6	81	43	36	36	SCD601-0420-2-2-140HA08-HP358	30803124
4,30	6	81	43	36	36	SCD601-0430-2-2-140HA08-HP358	30803125
4,40	6	81	43	36	36	SCD601-0440-2-2-140HA08-HP358	30803126
4,50	6	81	43	36	36	SCD601-0450-2-2-140HA08-HP358	30803127
4,60	6	81	43	36	36	SCD601-0460-2-2-140HA08-HP358	30803128
4,70	6	81	43	36	36	SCD601-0470-2-2-140HA08-HP358	30803129
4,80	6	95	57	48	36	SCD601-0480-2-2-140HA08-HP358	30803130
4,90	6	95	57	48	36	SCD601-0490-2-2-140HA08-HP358	30803131
5,00	6	95	57	48	36	SCD601-0500-2-2-140HA08-HP358	30803132
5,10	6	95	57	48	36	SCD601-0510-2-2-140HA08-HP358	30803133
5,20	6	95	57	48	36	SCD601-0520-2-2-140HA08-HP358	30803134
5,30	6	95	57	48	36	SCD601-0530-2-2-140HA08-HP358	30803135
5,40	6	95	57	48	36	SCD601-0540-2-2-140HA08-HP358	30803136
5,50	6	95	57	48	36	SCD601-0550-2-2-140HA08-HP358	30803137
5,60	6	95	57	48	36	SCD601-0560-2-2-140HA08-HP358	30803138
5,70	6	95	57	48	36	SCD601-0570-2-2-140HA08-HP358	30803139
5,80	6	95	57	48	36	SCD601-0580-2-2-140HA08-HP358	30803140
5,90	6	95	57	48	36	SCD601-0590-2-2-140HA08-HP358	30803141
6,00	6	95	57	48	36	SCD601-0600-2-2-140HA08-HP358	30803142
6,10	8	114	76	64	36	SCD601-0610-2-2-140HA08-HP358	30803143
6,20	8	114	76	64	36	SCD601-0620-2-2-140HA08-HP358	30803144
6,30	8	114	76	64	36	SCD601-0630-2-2-140HA08-HP358	30803145
6,40	8	114	76	64	36	SCD601-0640-2-2-140HA08-HP358	30803146

MEGA-Drill-Steel-Plus | Vollhartmetall-Spiralbohrer SCD601 (8xD), innere Kühlmittelzufuhr

Baumaße						Schaftform HA	
d ₁ m7	d ₂ h6	l ₁	l ₂	l ₃	l ₄	Spezifikation	Bestell-Nr.
6,50	8	114	76	64	36	SCD601-0650-2-2-140HA08-HP358	30803147
6,60	8	114	76	64	36	SCD601-0660-2-2-140HA08-HP358	30803148
6,70	8	114	76	64	36	SCD601-0670-2-2-140HA08-HP358	30803149
6,80	8	114	76	64	36	SCD601-0680-2-2-140HA08-HP358	30803150
6,90	8	114	76	64	36	SCD601-0690-2-2-140HA08-HP358	30803151
7,00	8	114	76	64	36	SCD601-0700-2-2-140HA08-HP358	30803152
7,10	8	114	76	64	36	SCD601-0710-2-2-140HA08-HP358	30803153
7,20	8	114	76	64	36	SCD601-0720-2-2-140HA08-HP358	30803154
7,30	8	114	76	64	36	SCD601-0730-2-2-140HA08-HP358	30803155
7,40	8	114	76	64	36	SCD601-0740-2-2-140HA08-HP358	30803156
7,50	8	114	76	64	36	SCD601-0750-2-2-140HA08-HP358	30803157
7,60	8	114	76	64	36	SCD601-0760-2-2-140HA08-HP358	30803158
7,70	8	114	76	64	36	SCD601-0770-2-2-140HA08-HP358	30803159
7,80	8	114	76	64	36	SCD601-0780-2-2-140HA08-HP358	30803160
7,90	8	114	76	64	36	SCD601-0790-2-2-140HA08-HP358	30803161
8,00	8	114	76	64	36	SCD601-0800-2-2-140HA08-HP358	30803162
8,10	10	142	95	80	40	SCD601-0810-2-2-140HA08-HP358	30803163
8,20	10	142	95	80	40	SCD601-0820-2-2-140HA08-HP358	30803164
8,40	10	142	95	80	40	SCD601-0840-2-2-140HA08-HP358	30803166
8,50	10	142	95	80	40	SCD601-0850-2-2-140HA08-HP358	30803167
8,60	10	142	95	80	40	SCD601-0860-2-2-140HA08-HP358	30803168
8,70	10	142	95	80	40	SCD601-0870-2-2-140HA08-HP358	30803169
8,80	10	142	95	80	40	SCD601-0880-2-2-140HA08-HP358	30803170
8,90	10	142	95	80	40	SCD601-0890-2-2-140HA08-HP358	30803171
9,00	10	142	95	80	40	SCD601-0900-2-2-140HA08-HP358	30803172
9,10	10	142	95	80	40	SCD601-0910-2-2-140HA08-HP358	30803173
9,20	10	142	95	80	40	SCD601-0920-2-2-140HA08-HP358	30803174
9,30	10	142	95	80	40	SCD601-0930-2-2-140HA08-HP358	30803175
9,40	10	142	95	80	40	SCD601-0940-2-2-140HA08-HP358	30803176
9,50	10	142	95	80	40	SCD601-0950-2-2-140HA08-HP358	30803177
9,60	10	142	95	80	40	SCD601-0960-2-2-140HA08-HP358	30803178
9,80	10	142	95	80	40	SCD601-0980-2-2-140HA08-HP358	30803180
9,90	10	142	95	80	40	SCD601-0990-2-2-140HA08-HP358	30803181
10,00	10	142	95	80	40	SCD601-1000-2-2-140HA08-HP358	30803182
10,10	12	162	114	96	45	SCD601-1010-2-2-140HA08-HP358	30803183
10,20	12	162	114	96	45	SCD601-1020-2-2-140HA08-HP358	30803184
10,30	12	162	114	95	45	SCD601-1030-2-2-140HA08-HP358	30803185
10,40	12	162	114	96	45	SCD601-1040-2-2-140HA08-HP358	30803186
10,50	12	162	114	96	45	SCD601-1050-2-2-140HA08-HP358	30803187
10,70	12	162	114	96	45	SCD601-1070-2-2-140HA08-HP358	30803189
10,80	12	162	114	96	45	SCD601-1080-2-2-140HA08-HP358	30803190
11,00	12	162	114	96	45	SCD601-1100-2-2-140HA08-HP358	30803192
11,10	12	162	114	96	45	SCD601-1110-2-2-140HA08-HP358	30803193
11,20	12	162	114	96	45	SCD601-1120-2-2-140HA08-HP358	30803194
11,30	12	162	114	96	45	SCD601-1130-2-2-140HA08-HP358	30803195
11,40	12	162	114	96	45	SCD601-1140-2-2-140HA08-HP358	30803196
11,50	12	162	114	96	45	SCD601-1150-2-2-140HA08-HP358	30803197
11,80	12	162	114	96	45	SCD601-1180-2-2-140HA08-HP358	30803200
12,00	12	162	114	96	45	SCD601-1200-2-2-140HA08-HP358	30803202
12,50	14	178	133	112	45	SCD601-1250-2-2-140HA08-HP358	30803203
12,80	14	178	133	112	45	SCD601-1280-2-2-140HA08-HP358	30803204
13,00	14	178	133	112	45	SCD601-1300-2-2-140HA08-HP358	30803205
13,50	14	178	133	112	45	SCD601-1350-2-2-140HA08-HP358	30803206
13,80	14	178	133	112	45	SCD601-1380-2-2-140HA08-HP358	30803207
14,00	14	178	133	112	45	SCD601-1400-2-2-140HA08-HP358	30803208
14,50	16	203	152	128	48	SCD601-1450-2-2-140HA08-HP358	30803209
14,80	16	203	152	128	48	SCD601-1480-2-2-140HA08-HP358	30803210

MEGA-Drill-Steel-Plus | Vollhartmetall-Spiralbohrer SCD601 (8xD), innere Kühlmittelzufuhr

Baumaße						Schaftform HA	
d ₁ m7	d ₂ h6	l ₁	l ₂	l ₃	l ₄	Spezifikation	Bestell-Nr.
15,00	16	203	152	128	48	SCD601-1500-2-2-140HA08-HP358	30803211
15,50	16	203	152	128	48	SCD601-1550-2-2-140HA08-HP358	30803212
15,80	16	203	152	128	48	SCD601-1580-2-2-140HA08-HP358	30803213
16,00	16	203	152	128	48	SCD601-1600-2-2-140HA08-HP358	30803214
17,00	18	222	171	144	48	SCD601-1700-2-2-140HA08-HP358	30803217
17,50	18	222	171	144	48	SCD601-1750-2-2-140HA08-HP358	30803218
17,80	18	222	171	144	48	SCD601-1780-2-2-140HA08-HP358	30803219
18,00	18	222	171	144	48	SCD601-1800-2-2-140HA08-HP358	30803220
18,50	20	243	190	160	50	SCD601-1850-2-2-140HA08-HP358	30803221
18,80	20	243	190	160	50	SCD601-1880-2-2-140HA08-HP358	30803222
19,50	20	243	190	160	50	SCD601-1950-2-2-140HA08-HP358	30803224
19,80	20	243	190	160	50	SCD601-1980-2-2-140HA08-HP358	30803225
20,00	20	243	190	160	50	SCD601-2000-2-2-140HA08-HP358	30803226

Konfigurierbare Merkmale



Durchmesser:
Durchmesser in Abstufungen
von 0,01 mm frei wählbar



Schaftform:
Schaftform: HB | HE

Spezifikation:

SCD601-[Durchmesser]-3-3-140[Schaftform]08-HP358

Abmessungen konfigurierbare Baureihe

d ₁ min.	d ₁ max.	d ₂ h6	l ₁	l ₂	l ₃	l ₄
3,00	3,70	6	72	34	29	36
3,71	4,70	6	81	43	36	36
4,71	6,00	6	95	57	48	36
6,01	8,00	8	114	76	64	36
8,01	10,00	10	142	95	80	40
10,01	12,00	12	162	114	96	45
12,01	14,00	14	178	133	112	45
14,01	16,00	16	203	152	128	48
16,01	18,00	18	222	171	144	48
18,01	20,00	20	243	190	160	50

Beispiel:

SCD601-0431-3-3-140HE08-HP358

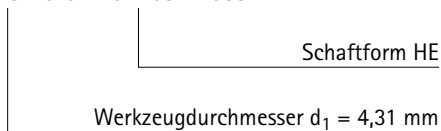

Maßangaben in mm.

Schnittwertempfehlung siehe Kapitelende.

Sonderausführungen und andere Beschichtungen auf Anfrage.

MEGA-Quadro-Drill-Plus

Vollhartmetall-Spiralbohrer

SCD610 (5xD), äußere Kühlmittelzufuhr, Nachfolgeprodukt des MEGA-Quadro-Drill (SCD16)

Ausführung:

Bohrerdurchmesser:	3,00 – 20,00 mm
Bohrungstoleranz:	≥ IT 8
Schneidstoff:	HP358
Schneidenanzahl:	2
Anzahl Führungsfasen:	4
Spitzenwinkel:	140°
Spiralwinkel:	30°

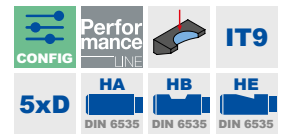
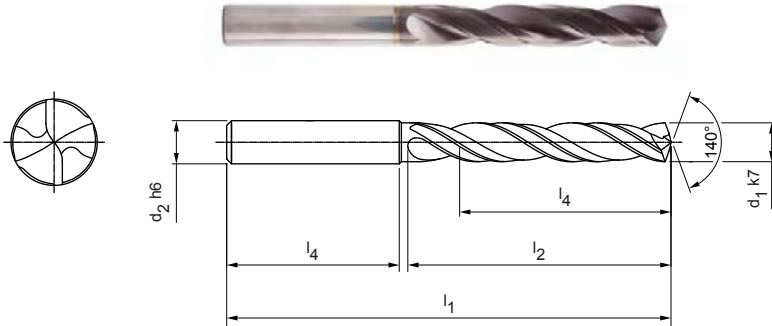

Lagerhaltige Vorzugsbaureihe in Schaftform HA

Baumaße						Schaftform HA	
d ₁ k7	d ₂ h6	l ₁	l ₂	l ₃	l ₄	Spezifikation	Bestell-Nr.
3,00	6	66	28	23	36	SCD610-0300-2-4-140HA05-HP358	31052631
3,10	6	66	28	23	36	SCD610-0310-2-4-140HA05-HP358	31052632
3,20	6	66	28	23	36	SCD610-0320-2-4-140HA05-HP358	31052633
3,30	6	66	28	23	36	SCD610-0330-2-4-140HA05-HP358	31052634
3,40	6	66	28	23	36	SCD610-0340-2-4-140HA05-HP358	31052635
3,50	6	66	28	23	36	SCD610-0350-2-4-140HA05-HP358	31052636
3,70	6	66	28	23	36	SCD610-0370-2-4-140HA05-HP358	31052638
4,00	6	74	36	29	36	SCD610-0400-2-4-140HA05-HP358	31052641
4,20	6	74	36	29	36	SCD610-0420-2-4-140HA05-HP358	31052643
4,30	6	74	36	29	36	SCD610-0430-2-4-140HA05-HP358	31052644
4,50	6	74	36	29	36	SCD610-0450-2-4-140HA05-HP358	31052646
4,80	6	82	44	35	36	SCD610-0480-2-4-140HA05-HP358	31052649
5,00	6	82	44	35	36	SCD610-0500-2-4-140HA05-HP358	31052651
5,10	6	82	44	35	36	SCD610-0510-2-4-140HA05-HP358	31052652
5,20	6	82	44	35	36	SCD610-0520-2-4-140HA05-HP358	31052653
5,50	6	82	44	35	36	SCD610-0550-2-4-140HA05-HP358	31052656
5,60	6	82	44	35	36	SCD610-0560-2-4-140HA05-HP358	31052657
5,80	6	82	44	35	36	SCD610-0580-2-4-140HA05-HP358	31052659
6,00	6	82	44	35	36	SCD610-0600-2-4-140HA05-HP358	31052661
6,40	8	91	53	43	36	SCD610-0640-2-4-140HA05-HP358	31052665
6,50	8	91	53	43	36	SCD610-0650-2-4-140HA05-HP358	31052666
6,80	8	91	53	43	36	SCD610-0680-2-4-140HA05-HP358	31052669
6,90	8	91	53	43	36	SCD610-0690-2-4-140HA05-HP358	31052670
7,00	8	91	53	43	36	SCD610-0700-2-4-140HA05-HP358	31052671
7,40	8	91	53	43	36	SCD610-0740-2-4-140HA05-HP358	31052675
7,50	8	91	53	43	36	SCD610-0750-2-4-140HA05-HP358	31052676
7,80	8	91	53	43	36	SCD610-0780-2-4-140HA05-HP358	31052679
8,00	8	91	53	43	36	SCD610-0800-2-4-140HA05-HP358	31052681
8,50	10	103	61	49	40	SCD610-0850-2-4-140HA05-HP358	31052686
8,60	10	103	61	49	40	SCD610-0860-2-4-140HA05-HP358	31052687
8,80	10	103	61	49	40	SCD610-0880-2-4-140HA05-HP358	31052689
9,00	10	103	61	49	40	SCD610-0900-2-4-140HA05-HP358	31052691
9,50	10	103	61	49	40	SCD610-0950-2-4-140HA05-HP358	31052696
9,80	10	103	61	49	40	SCD610-0980-2-4-140HA05-HP358	31052699
10,00	10	103	61	49	40	SCD610-1000-2-4-140HA05-HP358	31052701

MEGA-Quadro-Drill-Plus | Vollhartmetall-Spiralbohrer SCD610 (5xD), äußere Kühlmittelzufuhr

Baumaße						Schaftform HA	
d ₁ k7	d ₂ h6	l ₁	l ₂	l ₃	l ₄	Spezifikation	Bestell-Nr.
10,20	12	118	71	56	45	SCD610-1020-2-4-140HA05-HP358	31052703
10,30	12	118	71	56	45	SCD610-1030-2-4-140HA05-HP358	31052704
10,50	12	118	71	56	45	SCD610-1050-2-4-140HA05-HP358	31052706
10,90	12	118	71	56	45	SCD610-1090-2-4-140HA05-HP358	31052710
11,00	12	118	71	56	45	SCD610-1100-2-4-140HA05-HP358	31052711
11,50	12	118	71	56	45	SCD610-1150-2-4-140HA05-HP358	31052716
11,80	12	118	71	56	45	SCD610-1180-2-4-140HA05-HP358	31052719
12,00	12	118	71	56	45	SCD610-1200-2-4-140HA05-HP358	31052721
12,50	14	124	77	60	45	SCD610-1250-2-4-140HA05-HP358	31052722
13,00	14	124	77	60	45	SCD610-1300-2-4-140HA05-HP358	31052724
13,50	14	124	77	60	45	SCD610-1350-2-4-140HA05-HP358	31052725
14,00	14	124	77	60	45	SCD610-1400-2-4-140HA05-HP358	31052727
14,50	16	133	83	63	48	SCD610-1450-2-4-140HA05-HP358	31052728
15,00	16	133	83	63	48	SCD610-1500-2-4-140HA05-HP358	31052730
16,00	16	133	83	63	48	SCD610-1600-2-4-140HA05-HP358	31052733
17,00	18	143	93	71	48	SCD610-1700-2-4-140HA05-HP358	31052736
17,50	18	143	93	71	48	SCD610-1750-2-4-140HA05-HP358	31052737
18,00	18	143	93	71	48	SCD610-1800-2-4-140HA05-HP358	31052739
18,50	20	153	101	77	50	SCD610-1850-2-4-140HA05-HP358	31052740
20,00	20	153	101	77	50	SCD610-2000-2-4-140HA05-HP358	31052745

Konfigurierbare Merkmale



Durchmesser:
Durchmesser in Abstufungen
von 0,01 mm frei wählbar



Schaftform:
Schaftform: HB | HE

Spezifikation:

SCD610-[Durchmesser]-3-3-140[Schaftform]05-HP358

Abmessungen konfigurierbare Baureihe

d ₁ min.	d ₁ max.	d ₂ h6	l ₁	l ₂	l ₃	l ₄
3,00	3,70	6	66	28	23	36
3,71	4,70	6	74	36	29	36
4,71	6,00	6	82	44	35	36
6,01	8,00	8	91	53	43	36
8,01	10,00	10	103	61	49	40
10,01	12,00	12	118	71	56	45
12,01	14,00	14	124	77	60	45
14,01	16,00	16	133	83	63	48
16,01	18,00	18	143	93	71	48
18,01	20,00	20	153	101	77	50

Beispiel:

SCD610-0431-3-3-140HE05-HP358

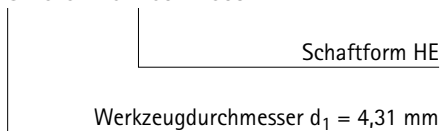

Dimensions in mm.

For cutting data recommendations, see end of chapter.

Special designs and other coatings available upon request.

MEGA-Quadro-Drill-Plus

Vollhartmetall-Spiralbohrer

SCD611 (5xD), innere Kühlmittelzufuhr, Nachfolgeprodukt des MEGA-Quadro-Drill (SCD16)

Ausführung:

- Bohrerdurchmesser: 3,00 – 20,00 mm
- Bohrungstoleranz: ≥ IT 8
- Schneidstoff: HP358
- Schneidenanzahl: 2
- Anzahl Führungsfasen: 4
- Spitzenwinkel: 140°
- Spiralwinkel: 30°

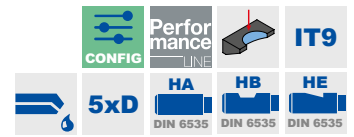
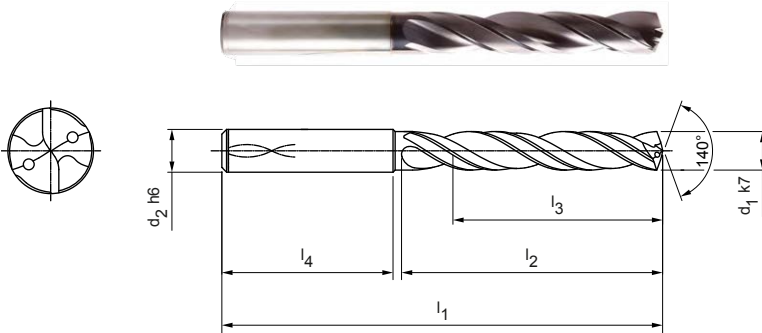

Lagerhaltige Vorzugsbaureihe in Schaftform HA

Baumaße						Schaftform HA	
d ₁ k7	d ₂ h6	l ₁	l ₂	l ₃	l ₄	Spezifikation	Bestell-Nr.
3,00	6	66	28	23	36	SCD611-0300-2-4-140HA05-HP358	31052795
3,10	6	66	28	23	36	SCD611-0310-2-4-140HA05-HP358	31052796
3,20	6	66	28	23	36	SCD611-0320-2-4-140HA05-HP358	31052797
3,30	6	66	28	23	36	SCD611-0330-2-4-140HA05-HP358	31052798
3,40	6	66	28	23	36	SCD611-0340-2-4-140HA05-HP358	31052799
3,50	6	66	28	23	36	SCD611-0350-2-4-140HA05-HP358	31052800
3,70	6	66	28	23	36	SCD611-0370-2-4-140HA05-HP358	31052802
3,80	6	74	36	29	36	SCD611-0380-2-4-140HA05-HP358	31052803
3,90	6	74	36	29	36	SCD611-0390-2-4-140HA05-HP358	31052804
4,00	6	74	36	29	36	SCD611-0400-2-4-140HA05-HP358	31052805
4,20	6	74	36	29	36	SCD611-0420-2-4-140HA05-HP358	31052807
4,30	6	74	36	29	36	SCD611-0430-2-4-140HA05-HP358	31052808
4,50	6	74	36	29	36	SCD611-0450-2-4-140HA05-HP358	31052810
4,80	6	82	44	35	36	SCD611-0480-2-4-140HA05-HP358	31052813
5,00	6	82	44	35	36	SCD611-0500-2-4-140HA05-HP358	31052815
5,10	6	82	44	35	36	SCD611-0510-2-4-140HA05-HP358	31052816
5,20	6	82	44	35	36	SCD611-0520-2-4-140HA05-HP358	31052817
5,30	6	82	44	35	36	SCD611-0530-2-4-140HA05-HP358	31052818
5,50	6	82	44	35	36	SCD611-0550-2-4-140HA05-HP358	31052820
5,60	6	82	44	35	36	SCD611-0560-2-4-140HA05-HP358	31052821
5,80	6	82	44	35	36	SCD611-0580-2-4-140HA05-HP358	31052823
5,90	6	82	44	35	36	SCD611-0590-2-4-140HA05-HP358	31052824
6,00	6	82	44	35	36	SCD611-0600-2-4-140HA05-HP358	31052825
6,40	8	91	53	43	36	SCD611-0640-2-4-140HA05-HP358	31052829
6,50	8	91	53	43	36	SCD611-0650-2-4-140HA05-HP358	31052830
6,60	8	91	53	43	36	SCD611-0660-2-4-140HA05-HP358	31052831
6,70	8	91	53	43	36	SCD611-0670-2-4-140HA05-HP358	31052832
6,80	8	91	53	43	36	SCD611-0680-2-4-140HA05-HP358	31052833
6,90	8	91	53	43	36	SCD611-0690-2-4-140HA05-HP358	31052834
7,00	8	91	53	43	36	SCD611-0700-2-4-140HA05-HP358	31052835
7,20	8	91	53	43	36	SCD611-0720-2-4-140HA05-HP358	31052837
7,40	8	91	53	43	36	SCD611-0740-2-4-140HA05-HP358	31052839
7,50	8	91	53	43	36	SCD611-0750-2-4-140HA05-HP358	31052840
7,80	8	91	53	43	36	SCD611-0780-2-4-140HA05-HP358	31052843
7,90	8	91	53	43	36	SCD611-0790-2-4-140HA05-HP358	31052844

MEGA-Quadro-Drill-Plus | Vollhartmetall-Spiralbohrer SCD611 (5xD), innere Kühlmittelzufuhr

Baumaße						Schaftform HA	
d ₁ k7	d ₂ h6	l ₁	l ₂	l ₃	l ₄	Spezifikation	Bestell-Nr.
8,00	8	91	53	43	36	SCD611-0800-2-4-140HA05-HP358	31052845
8,10	10	103	61	49	40	SCD611-0810-2-4-140HA05-HP358	31052846
8,30	10	103	61	49	40	SCD611-0830-2-4-140HA05-HP358	31052848
8,40	10	103	61	49	40	SCD611-0840-2-4-140HA05-HP358	31052849
8,50	10	103	61	49	40	SCD611-0850-2-4-140HA05-HP358	31052850
8,60	10	103	61	49	40	SCD611-0860-2-4-140HA05-HP358	31052851
8,80	10	103	61	49	40	SCD611-0880-2-4-140HA05-HP358	31052853
9,00	10	103	61	49	40	SCD611-0900-2-4-140HA05-HP358	31052855
9,20	10	103	61	49	40	SCD611-0920-2-4-140HA05-HP358	31052857
9,30	10	103	61	49	40	SCD611-0930-2-4-140HA05-HP358	31052858
9,50	10	103	61	49	40	SCD611-0950-2-4-140HA05-HP358	31052860
9,80	10	103	61	49	40	SCD611-0980-2-4-140HA05-HP358	31052863
9,90	10	103	61	49	40	SCD611-0990-2-4-140HA05-HP358	31052864
10,00	10	103	61	49	40	SCD611-1000-2-4-140HA05-HP358	31052865
10,20	12	118	71	56	45	SCD611-1020-2-4-140HA05-HP358	31052867
10,30	12	118	71	56	45	SCD611-1030-2-4-140HA05-HP358	31052868
10,40	12	118	71	56	45	SCD611-1040-2-4-140HA05-HP358	31052869
10,50	12	118	71	56	45	SCD611-1050-2-4-140HA05-HP358	31052870
10,90	12	118	71	56	45	SCD611-1090-2-4-140HA05-HP358	31052874
11,00	12	118	71	56	45	SCD611-1100-2-4-140HA05-HP358	31052875
11,50	12	118	71	56	45	SCD611-1150-2-4-140HA05-HP358	31052880
11,70	12	118	71	56	45	SCD611-1170-2-4-140HA05-HP358	31052882
11,80	12	118	71	56	45	SCD611-1180-2-4-140HA05-HP358	31052883

Konfigurierbare Merkmale



Durchmesser:
Durchmesser in Abstufungen
von 0,01 mm frei wählbar



Schaftform:
Schaftform: HB | HE

Spezifikation:

SCD611-[Durchmesser]-3-3-140[Schaftform]05-HP358

Abmessungen konfigurierbare Baureihe

d ₁ min.	d ₁ max.	d ₂ h6	l ₁	l ₂	l ₃	l ₄
3,00	3,70	6	66	28	23	36
3,71	4,70	6	74	36	29	36
4,71	6,00	6	82	44	35	36
6,01	8,00	8	91	53	43	36
8,01	10,00	10	103	61	49	40
10,01	12,00	12	118	71	56	45
12,01	14,00	14	124	77	60	45
14,01	16,00	16	133	83	63	48
16,01	18,00	18	143	93	71	48
18,01	20,00	20	153	101	77	50

Beispiel:

SCD611-0431-3-3-140HE05-HP358

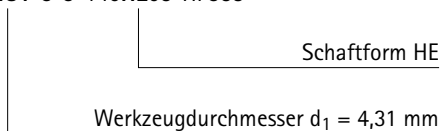

Maßangaben in mm.

Schnittwertempfehlung siehe Kapitelende.

Sonderausführungen und andere Beschichtungen auf Anfrage.

MEGA-Quadro-Drill-Plus

Vollhartmetall-Spiralbohrer

SCD611 (8xD), innere Kühlmittelzufuhr, Nachfolgeprodukt des MEGA-Quadro-Drill (SCD16)

Ausführung:

- Bohrerdurchmesser: 3,00 – 20,00 mm
- Bohrungstoleranz: \geq IT 8
- Schneidstoff: HP358
- Schneidenanzahl: 2
- Anzahl Führungsfasen: 4
- Spitzenwinkel: 140°
- Spiralwinkel: 30°

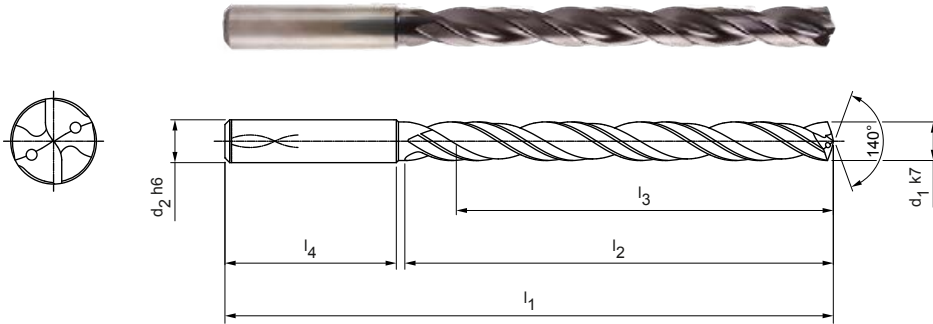

Lagerhaltige Vorzugsbaureihe in Schaftform HA

Baumaße						Schaftform HA	
d ₁ k7	d ₂ h6	l ₁	l ₂	l ₃	l ₄	Spezifikation	Bestell-Nr.
3,00	6	72	34	29	36	SCD611-0300-2-4-140HA08-HP358	31052910
3,10	6	72	34	29	36	SCD611-0310-2-4-140HA08-HP358	31052911
3,20	6	72	34	29	36	SCD611-0320-2-4-140HA08-HP358	31052912
3,30	6	72	34	29	36	SCD611-0330-2-4-140HA08-HP358	31052913
3,40	6	72	34	29	36	SCD611-0340-2-4-140HA08-HP358	31052914
3,50	6	72	34	29	36	SCD611-0350-2-4-140HA08-HP358	31052915
3,60	6	72	34	29	36	SCD611-0360-2-4-140HA08-HP358	31052916
3,70	6	72	34	29	36	SCD611-0370-2-4-140HA08-HP358	31052917
3,80	6	81	43	36	36	SCD611-0380-2-4-140HA08-HP358	31052918
3,90	6	81	43	36	36	SCD611-0390-2-4-140HA08-HP358	31052919
4,00	6	81	43	36	36	SCD611-0400-2-4-140HA08-HP358	31052920
4,10	6	81	43	36	36	SCD611-0410-2-4-140HA08-HP358	31052921
4,20	6	81	43	36	36	SCD611-0420-2-4-140HA08-HP358	31052922
4,30	6	81	43	36	36	SCD611-0430-2-4-140HA08-HP358	31052923
4,40	6	81	43	36	36	SCD611-0440-2-4-140HA08-HP358	31052924
4,50	6	81	43	36	36	SCD611-0450-2-4-140HA08-HP358	31052925
4,60	6	81	43	36	36	SCD611-0460-2-4-140HA08-HP358	31052926
4,80	6	95	57	48	36	SCD611-0480-2-4-140HA08-HP358	31052928
4,90	6	95	57	48	36	SCD611-0490-2-4-140HA08-HP358	31052929
5,00	6	95	57	48	36	SCD611-0500-2-4-140HA08-HP358	31052930
5,10	6	95	57	48	36	SCD611-0510-2-4-140HA08-HP358	31052931
5,20	6	95	57	48	36	SCD611-0520-2-4-140HA08-HP358	31052932
5,40	6	95	57	48	36	SCD611-0540-2-4-140HA08-HP358	31052934
5,50	6	95	57	48	36	SCD611-0550-2-4-140HA08-HP358	31052935
5,60	6	95	57	48	36	SCD611-0560-2-4-140HA08-HP358	31052936
5,70	6	95	57	48	36	SCD611-0570-2-4-140HA08-HP358	31052937
5,80	6	95	57	48	36	SCD611-0580-2-4-140HA08-HP358	31052938
6,00	6	95	57	48	36	SCD611-0600-2-4-140HA08-HP358	31052940
6,10	8	114	76	64	36	SCD611-0610-2-4-140HA08-HP358	31052941
6,20	8	114	76	64	36	SCD611-0620-2-4-140HA08-HP358	31052942
6,50	8	114	76	64	36	SCD611-0650-2-4-140HA08-HP358	31052945
6,60	8	114	76	64	36	SCD611-0660-2-4-140HA08-HP358	31052946
6,80	8	114	76	64	36	SCD611-0680-2-4-140HA08-HP358	31052948
6,90	8	114	76	64	36	SCD611-0690-2-4-140HA08-HP358	31052949
7,00	8	114	76	64	36	SCD611-0700-2-4-140HA08-HP358	31052950

MEGA-Quadro-Drill-Plus | Vollhartmetall-Spiralbohrer SCD611 (8xD), innere Kühlmittelzufuhr

Baumaße						Schaftform HA	
d ₁ k7	d ₂ h6	l ₁	l ₂	l ₃	l ₄	Spezifikation	Bestell-Nr.
7,20	8	114	76	64	36	SCD611-0720-2-4-140HA08-HP358	31052952
7,40	8	114	76	64	36	SCD611-0740-2-4-140HA08-HP358	31052954
7,50	8	114	76	64	36	SCD611-0750-2-4-140HA08-HP358	31052955
7,60	8	114	76	64	36	SCD611-0760-2-4-140HA08-HP358	31052956
7,80	8	114	76	64	36	SCD611-0780-2-4-140HA08-HP358	31052958
8,00	8	114	76	64	36	SCD611-0800-2-4-140HA08-HP358	31052960
8,20	10	142	95	80	40	SCD611-0820-2-4-140HA08-HP358	31052962
8,50	10	142	95	80	40	SCD611-0850-2-4-140HA08-HP358	31052965
8,60	10	142	95	80	40	SCD611-0860-2-4-140HA08-HP358	31052966
8,70	10	142	95	80	40	SCD611-0870-2-4-140HA08-HP358	31052967
8,90	10	142	95	80	40	SCD611-0890-2-4-140HA08-HP358	31052969
9,00	10	142	95	80	40	SCD611-0900-2-4-140HA08-HP358	31052970
9,50	10	142	95	80	40	SCD611-0950-2-4-140HA08-HP358	31052975
9,60	10	142	95	80	40	SCD611-0960-2-4-140HA08-HP358	31052976
9,70	10	142	95	80	40	SCD611-0970-2-4-140HA08-HP358	31052977
9,80	10	142	95	80	40	SCD611-0980-2-4-140HA08-HP358	31052978
9,90	10	142	95	80	40	SCD611-0990-2-4-140HA08-HP358	31052979
10,00	10	142	95	80	40	SCD611-1000-2-4-140HA08-HP358	31052980
10,10	12	162	114	96	45	SCD611-1010-2-4-140HA08-HP358	31052981
10,20	12	162	114	96	45	SCD611-1020-2-4-140HA08-HP358	31052982
10,50	12	162	114	96	45	SCD611-1050-2-4-140HA08-HP358	31052985
10,60	12	162	114	96	45	SCD611-1060-2-4-140HA08-HP358	31052986
10,70	12	162	114	96	45	SCD611-1070-2-4-140HA08-HP358	31052987
11,00	12	162	114	96	45	SCD611-1100-2-4-140HA08-HP358	31052990
11,30	12	162	114	96	45	SCD611-1130-2-4-140HA08-HP358	31052993
11,70	12	162	114	96	45	SCD611-1170-2-4-140HA08-HP358	31052997
11,80	12	162	114	96	45	SCD611-1180-2-4-140HA08-HP358	31052998
12,00	12	162	114	96	45	SCD611-1200-2-4-140HA08-HP358	31053000
12,50	14	178	133	112	45	SCD611-1250-2-4-140HA08-HP358	31053001
12,80	14	178	133	112	45	SCD611-1280-2-4-140HA08-HP358	31053002
13,00	14	178	133	112	45	SCD611-1300-2-4-140HA08-HP358	31053003
13,50	14	178	133	112	45	SCD611-1350-2-4-140HA08-HP358	31053004
14,00	14	178	133	112	45	SCD611-1400-2-4-140HA08-HP358	31053006
15,00	16	203	152	128	48	SCD611-1500-2-4-140HA08-HP358	31053009
15,80	16	203	152	128	48	SCD611-1580-2-4-140HA08-HP358	31053011
16,00	16	203	152	128	48	SCD611-1600-2-4-140HA08-HP358	31053012
16,50	18	222	171	144	48	SCD611-1650-2-4-140HA08-HP358	31053013
20,00	20	243	190	160	50	SCD611-2000-2-4-140HA08-HP358	31053024

Konfigurierbare Merkmale



Durchmesser:
Durchmesser in Abstufungen
von 0,01 mm frei wählbar



Schaftform:
Schaftform: HB | HE

Spezifikation:

SCD611-[Durchmesser]-3-3-140[Schaftform]08-HP358

Abmessungen konfigurierbare Baureihe

d ₁ min.	d ₁ max.	d ₂ h6	l ₁	l ₂	l ₃	l ₄
3,00	3,70	6	72	34	29	36
3,71	4,70	6	81	43	36	36
4,71	6,00	6	95	57	48	36
6,01	8,00	8	114	76	64	36
8,01	10,00	10	142	95	80	40
10,01	12,00	12	162	114	96	45
12,01	14,00	14	178	133	112	45
14,01	16,00	16	203	152	128	48
16,01	18,00	18	222	171	144	48
18,01	20,00	20	243	190	160	50

Beispiel:

SCD611-0431-2-4-140HE08-HP358

Schaftform HE

Werkzeughdurchmesser d₁ = 4,31 mm

Maßangaben in mm.

Schnittwertempfehlung siehe Kapitelende.

Sonderausführungen und andere Beschichtungen auf Anfrage.

MEGA-Quadro-Drill-Plus

Vollhartmetall-Spiralbohrer

SCD611 (12xD), innere Kühlmittelzufuhr, Nachfolgeprodukt des MEGA-Quadro-Drill (SCD16)

Ausführung:

- Bohrerdurchmesser: 3,00 – 20,00 mm
- Bohrungstoleranz: ≥ IT 8
- Schneidstoff: HP358
- Schneidenanzahl: 2
- Anzahl Führungsfasen: 4
- Spitzenwinkel: 140°
- Spiralwinkel: 30°

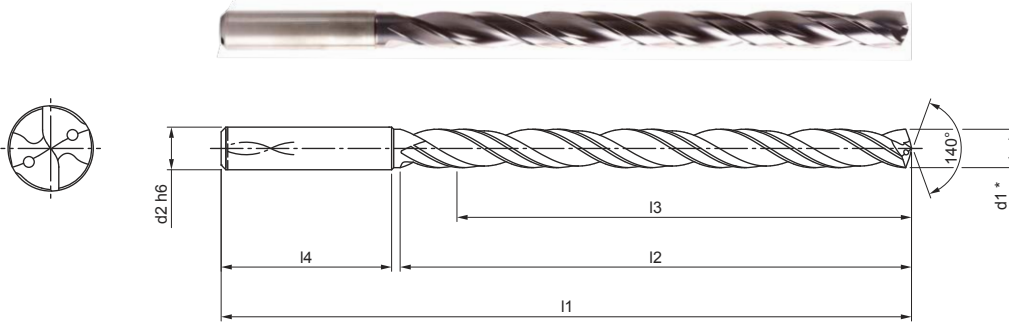

Lagerhaltige Vorzugsbaureihe in Schaftform HA

Baumaße						Schaftform HA	
d ₁ k7	d ₂ h6	l ₁	l ₂	l ₃	l ₄	Spezifikation	Bestell-Nr.
3,00	6	92	54	48	36	SCD611-0300-2-4-140HA12-HP358	31053025
3,10	6	92	54	48	36	SCD611-0310-2-4-140HA12-HP358	31053026
3,20	6	92	54	48	36	SCD611-0320-2-4-140HA12-HP358	31053027
3,30	6	92	54	48	36	SCD611-0330-2-4-140HA12-HP358	31053028
3,40	6	92	54	48	36	SCD611-0340-2-4-140HA12-HP358	31053029
3,50	6	92	54	48	36	SCD611-0350-2-4-140HA12-HP358	31053030
3,60	6	92	54	48	36	SCD611-0360-2-4-140HA12-HP358	31053031
3,70	6	92	54	48	36	SCD611-0370-2-4-140HA12-HP358	31053032
3,80	6	102	64	58	36	SCD611-0380-2-4-140HA12-HP358	31053033
3,90	6	102	64	58	36	SCD611-0390-2-4-140HA12-HP358	31053034
4,00	6	102	64	58	36	SCD611-0400-2-4-140HA12-HP358	31053035
4,05	6	102	64	58	36	SCD611-0405-2-4-140HA12-HP358	31300718
4,10	6	102	64	58	36	SCD611-0410-2-4-140HA12-HP358	31053036
4,20	6	102	64	58	36	SCD611-0420-2-4-140HA12-HP358	31053037
4,30	6	102	64	58	36	SCD611-0430-2-4-140HA12-HP358	31053038
4,40	6	102	64	58	36	SCD611-0440-2-4-140HA12-HP358	31053039
4,50	6	102	64	58	36	SCD611-0450-2-4-140HA12-HP358	31053040
4,60	6	102	64	58	36	SCD611-0460-2-4-140HA12-HP358	31053041
4,65	6	116	78	58	36	SCD611-0465-2-4-140HA12-HP358	31179333
4,70	6	102	64	58	36	SCD611-0470-2-4-140HA12-HP358	31053042
4,80	6	116	78	70	36	SCD611-0480-2-4-140HA12-HP358	31053043
5,00	6	116	78	70	36	SCD611-0500-2-4-140HA12-HP358	31053045
5,05	6	116	78	70	36	SCD611-0505-2-4-140HA12-HP358	31245107
5,10	6	116	78	70	36	SCD611-0510-2-4-140HA12-HP358	31053046
5,20	6	116	78	70	36	SCD611-0520-2-4-140HA12-HP358	31053047
5,40	6	116	78	70	36	SCD611-0540-2-4-140HA12-HP358	31053049
5,50	6	116	78	70	36	SCD611-0550-2-4-140HA12-HP358	31053050
5,60	6	116	78	70	36	SCD611-0560-2-4-140HA12-HP358	31053051
5,70	6	116	78	70	36	SCD611-0570-2-4-140HA12-HP358	31053052
5,80	6	116	78	70	36	SCD611-0580-2-4-140HA12-HP358	31053053
6,00	6	116	78	70	36	SCD611-0600-2-4-140HA12-HP358	31053055
6,10	8	146	108	94	36	SCD611-0610-2-4-140HA12-HP358	31053056
6,40	8	146	108	94	36	SCD611-0640-2-4-140HA12-HP358	31053059
6,50	8	146	108	94	36	SCD611-0650-2-4-140HA12-HP358	31053060
6,80	8	146	108	94	36	SCD611-0680-2-4-140HA12-HP358	31053063

MEGA-Quadro-Drill-Plus | Vollhartmetall-Spiralbohrer SCD611 (12xD), innere Kühlmittelzufuhr

Baumaße						Schaftform HA	
d ₁ k7	d ₂ h6	l ₁	l ₂	l ₃	l ₄	Spezifikation	Bestell-Nr.
6,90	8	146	108	94	36	SCD611-0690-2-4-140HA12-HP358	31053064
7,00	8	146	108	94	36	SCD611-0700-2-4-140HA12-HP358	31053065
7,10	8	146	108	94	36	SCD611-0710-2-4-140HA12-HP358	31053066
7,50	8	146	108	94	36	SCD611-0750-2-4-140HA12-HP358	31053070
7,60	8	146	108	94	36	SCD611-0760-2-4-140HA12-HP358	31053071
7,70	8	146	108	94	36	SCD611-0770-2-4-140HA12-HP358	31053072
7,80	8	146	108	94	36	SCD611-0780-2-4-140HA12-HP358	31053073
7,90	8	146	108	94	36	SCD611-0790-2-4-140HA12-HP358	31053074
8,00	8	146	108	94	36	SCD611-0800-2-4-140HA12-HP358	31053075
8,20	10	162	120	110	40	SCD611-0820-2-4-140HA12-HP358	31053077
8,30	10	162	120	110	40	SCD611-0830-2-4-140HA12-HP358	31053078
8,40	10	162	120	110	40	SCD611-0840-2-4-140HA12-HP358	31053079
8,50	10	162	120	110	40	SCD611-0850-2-4-140HA12-HP358	31053080
8,60	10	162	120	110	40	SCD611-0860-2-4-140HA12-HP358	31053081
8,70	10	162	120	110	40	SCD611-0870-2-4-140HA12-HP358	31053082
9,00	10	162	120	110	40	SCD611-0900-2-4-140HA12-HP358	31053085
9,50	10	162	120	110	40	SCD611-0950-2-4-140HA12-HP358	31053090
9,60	10	162	120	110	40	SCD611-0960-2-4-140HA12-HP358	31053091
9,80	10	162	120	110	40	SCD611-0980-2-4-140HA12-HP358	31053093
9,90	10	162	120	110	40	SCD611-0990-2-4-140HA12-HP358	31053094
10,00	10	162	120	110	40	SCD611-1000-2-4-140HA12-HP358	31053095
10,20	12	204	156	142	45	SCD611-1020-2-4-140HA12-HP358	31053097
10,50	12	204	156	142	45	SCD611-1050-2-4-140HA12-HP358	31053100
10,60	12	204	156	142	45	SCD611-1060-2-4-140HA12-HP358	31053101
11,00	12	204	156	142	45	SCD611-1100-2-4-140HA12-HP358	31053105
11,20	12	204	156	142	45	SCD611-1120-2-4-140HA12-HP358	31053107
11,70	12	204	156	142	45	SCD611-1170-2-4-140HA12-HP358	31053112
11,80	12	204	156	142	45	SCD611-1180-2-4-140HA12-HP358	31053113
12,00	12	204	156	142	45	SCD611-1200-2-4-140HA12-HP358	31053115
12,50	14	230	182	166	45	SCD611-1250-2-4-140HA12-HP358	31053116
13,00	14	230	182	166	45	SCD611-1300-2-4-140HA12-HP358	31053118
13,50	14	230	182	166	45	SCD611-1350-2-4-140HA12-HP358	31053119
14,00	14	230	182	166	45	SCD611-1400-2-4-140HA12-HP358	31053121
14,50	16	260	208	192	48	SCD611-1450-2-4-140HA12-HP358	31053122
15,00	16	260	208	192	48	SCD611-1500-2-4-140HA12-HP358	31053124
16,00	16	260	208	192	48	SCD611-1600-2-4-140HA12-HP358	31053127
16,50	18	285	234	216	48	SCD611-1650-2-4-140HA12-HP358	31053128
17,50	18	285	234	216	48	SCD611-1750-2-4-140HA12-HP358	31053131
19,50	20	310	258	240	50	SCD611-1950-2-4-140HA12-HP358	31053137

Fortsetzung auf nächster Seite.

MEGA-Quadro-Drill-Plus | Vollhartmetall-Spiralbohrer SCD611 (12xD), innere Kühlmittelzufuhr

Konfigurierbare Merkmale



Durchmesser:
Durchmesser in Abstufungen
von 0,01 mm frei wählbar



Schaftform:
Schaftform: HB | HE

Spezifikation:

SCD611-[Durchmesser]-2-4-140[Schaftform]12-HP358

Abmessungen konfigurierbare Baureihe

d ₁ min.	d ₁ max.	d ₂ h6	l ₁	l ₂	l ₃	l ₄
3,00	3,70	6	92	54	48	36
3,71	4,70	6	102	64	58	36
4,71	6,00	6	116	78	70	36
6,01	8,00	8	146	108	94	36
8,01	10,00	10	162	120	110	40
10,01	12,00	12	204	156	142	45
12,01	14,00	14	230	182	166	45
14,01	16,00	16	260	208	192	48
16,01	18,00	18	285	234	216	48
18,01	20,00	20	310	258	240	50

Beispiel:

SCD611-0431-2-4-140HE12-HP358

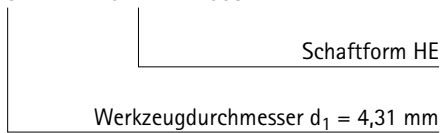

MICRO-Drill-Steel

Vollhartmetall-Spiralbohrer
SCD371 (5xD), innere Kühlmittelzufuhr

Ausführung:
Bohrerdurchmesser: 0,80 – 2,99 mm
Bohrungstoleranz: IT9 (erreichbar)
Schneidstoff: HP246
Schneidenanzahl: 2
Anzahl Führungsfasen: 4
Spitzenwinkel: 142°
Spiralwinkel: 30°

Anwendung:
Speziell auf MEGA-Deep-Drill abgestimmter Pilotbohrer.
Maximal einsetzbar bis < Durchmesser 3,00 mm.

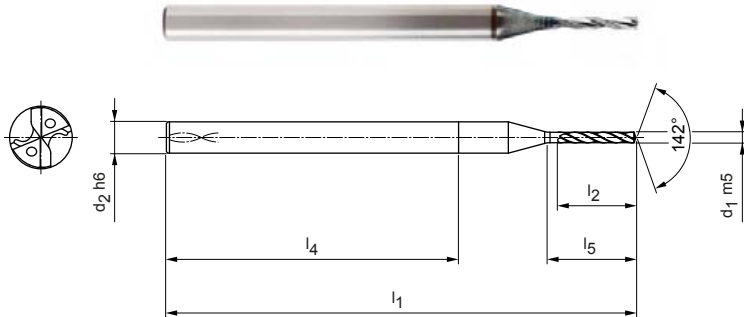

Lagerhaltige Vorzugsbaureihe in Schaftform HA

Baumaße						Schaftform HA	
d ₁ m5	d ₂ h6	l ₁	l ₂	l ₃	l ₄	Spezifikation	Bestell-Nr.
0,80	3	45	6	4	28	SCD371-0080-2-4-142HA05-HP246	31238823
1,00	3	45	7,5	5	28	SCD371-0100-2-4-142HA05-HP246	31238825
1,20	3	45	9	6	28	SCD371-0120-2-4-142HA05-HP246	31238827
1,50	3	45	11,3	7,5	28	SCD371-0150-2-4-142HA05-HP246	31238890
1,60	3	50	12	8	28	SCD371-0160-2-4-142HA05-HP246	31238891
2,00	3	50	15	10	28	SCD371-0200-2-4-142HA05-HP246	31238895
2,40	3	52	18	12	28	SCD371-0240-2-4-142HA05-HP246	31238899
2,50	3	52	18,8	12,5	28	SCD371-0250-2-4-142HA05-HP246	31238900
2,60	3	55	19,5	13	28	SCD371-0260-2-4-142HA05-HP246	31238901
2,80	3	55	21	14	28	SCD371-0280-2-4-142HA05-HP246	31238903

Konfigurierbare Merkmale



Durchmesser:
Durchmesser in Abstufungen
von 0,01 mm frei wählbar



Spezifikation:

SCD371-[Durchmesser]-2-4-142HA05-HP246

Beispiel:
SCD371-0221-2-4-142HA05-HP246

Werkzeugdurchmesser d₁ = 2,21 mm

Abmessungen konfigurierbare Baureihe

d ₁ min.	d ₁ max.	d ₂ h6	l ₁	l ₂	l ₃	l ₄
0,80	0,99	3	45	6,0	4,0	28
1,00	1,29	3	45	7,5	5,0	28
1,30	1,59	3	45	9,8	6,5	28
1,60	1,89	3	50	12,0	8,0	28
1,90	2,19	3	50	14,3	9,5	28
2,20	2,59	3	52	16,5	11,0	28
2,60	2,99	3	55	19,5	13,0	28

Maßangaben in mm.

Schnittwertempfehlung siehe Kapitelende.

Sonderausführungen und andere Beschichtungen auf Anfrage.

MICRO-Drill-Steel

Vollhartmetall-Spiralbohrer
SCD371 (8xD), innere Kühlmittelzufuhr

Ausführung:
Bohrerdurchmesser: 1,00 – 2,99 mm
Bohrungstoleranz: IT9 (erreichbar)
Schneidstoff: HP246
Schneidenanzahl: 2
Anzahl Führungsfasen: 4
Spitzenwinkel: 142°
Spiralwinkel: 30°

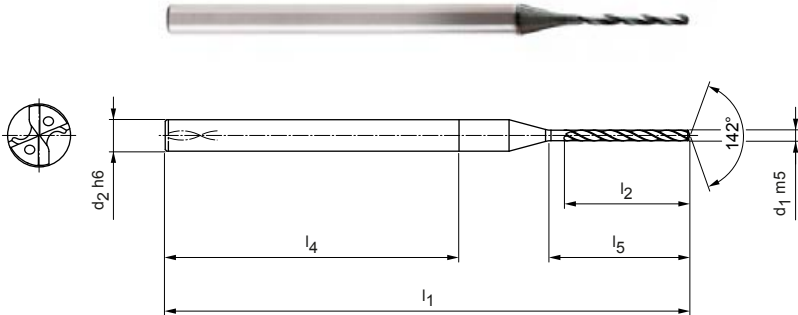

Lagerhaltige Vorzugsbaureihe in Schaftform HA

Baumaße						Schaftform HA	
d ₁ m5	d ₂ h6	l ₁	l ₂	l ₃	l ₄	Spezifikation	Bestell-Nr.
1,00	3	50	12	8	28	SCD371-0100-2-4-142HA08-HP246	31238905
1,20	3	50	14,4	9,6	28	SCD371-0120-2-4-142HA08-HP246	31238907
1,50	3	52	18	12	28	SCD371-0150-2-4-142HA08-HP246	31238910
1,60	3	55	19,2	12,8	28	SCD371-0160-2-4-142HA08-HP246	31238911
2,00	3	60	24	16	28	SCD371-0200-2-4-142HA08-HP246	31238915
2,50	3	62	30	20	28	SCD371-0250-2-4-142HA08-HP246	31238920

Konfigurierbare Merkmale



Durchmesser:
Durchmesser in Abstufungen von 0,01 mm frei wählbar

Spezifikation:
SCD371-[Durchmesser]-2-4-142HA08-HP246

Abmessungen konfigurierbare Baureihe

d ₁ min.	d ₁ max.	d ₂ h6	l ₁	l ₂	l ₃	l ₄
1,00	1,29	3	50	12,0	8,0	28
1,30	1,59	3	52	15,6	10,4	28
1,60	1,89	3	55	19,2	12,8	28
1,90	2,19	3	60	22,8	15,2	28
2,20	2,59	3	62	26,4	17,6	28
2,60	2,99	3	66	31,2	20,8	28

Beispiel:

SCD371-0221-2-4-142HA08-HP246

Werkzeugdurchmesser d₁ = 2,21 mm

Maßangaben in mm.

Schnittwertempfehlung siehe Kapitelende.

Sonderausführungen und andere Beschichtungen auf Anfrage.

MICRO-Drill-Steel

Vollhartmetall-Spiralbohrer
SCD371 (12xD), innere Kühlmittelzufuhr

Ausführung:

Bohrerdurchmesser: 1,00 – 2,99 mm
Bohrungstoleranz: IT9 (erreichbar)
Schneidstoff: HP246
Schneidenanzahl: 2
Anzahl Führungsfasen: 4
Spitzenwinkel: 142°
Spiralwinkel: 30°

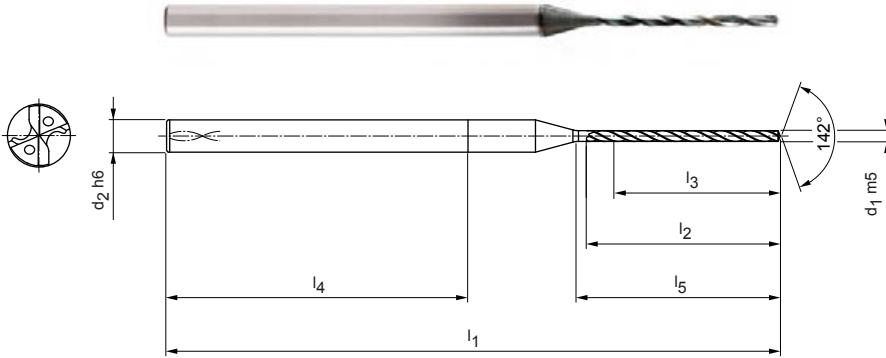

Lagerhaltige Vorzugsbaureihe in Schaftform HA

Baumaße						Schaftform HA	
d ₁ m5	d ₂ h6	l ₁	l ₂	l ₃	l ₄	Spezifikation	Bestell-Nr.
1,00	3	57	18	12	28	SCD371-0100-2-4-142HA12-HP246	31238925
1,20	3	57	21,6	14,4	28	SCD371-0120-2-4-142HA12-HP246	31238927
1,30	3	62	23,4	15,6	28	SCD371-0130-2-4-142HA12-HP246	31238928
1,50	3	62	27	18	28	SCD371-0150-2-4-142HA12-HP246	31238930
2,00	3	72	36	24	28	SCD371-0200-2-4-142HA12-HP246	31238935
2,50	3	79	45	30	28	SCD371-0250-2-4-142HA12-HP246	31238940

Konfigurierbare Merkmale



Durchmesser:
Durchmesser in Abstufungen
von 0,01 mm frei wählbar



Spezifikation:

SCD371-[Durchmesser]-2-4-142HA12-HP246

Beispiel:

SCD371-0221-2-4-142HA12-HP246

Werkzeugdurchmesser d₁ = 2,21 mm

Abmessungen konfigurierbare Baureihe

d ₁ min.	d ₁ max.	d ₂ h6	l ₁	l ₂	l ₃	l ₄
1,00	1,29	3	57	18,0	12,0	28
1,30	1,59	3	62	23,4	15,6	28
1,60	1,89	3	66	28,8	19,2	28
1,90	2,19	3	72	34,2	22,8	28
2,20	2,59	3	79	39,6	26,4	28
2,60	2,99	3	85	46,8	31,2	28

Maßangaben in mm.

Schnittwertempfehlung siehe Kapitelende.

Sonderausführungen und andere Beschichtungen auf Anfrage.

MEGA-Drill-Hardened

Vollhartmetall-Spiralbohrer
SCD140 (3xD)

Ausführung:

Bohrerdurchmesser: 2,55 – 20,00 mm
 Bohrungstoleranz: IT 9 (erreichbar)
 Schneidstoff: HP809
 Schneidanzahl: 2
 Anzahl Führungsfasen: 2
 Spitzenwinkel: 140°
 Spiralwinkel: 15°

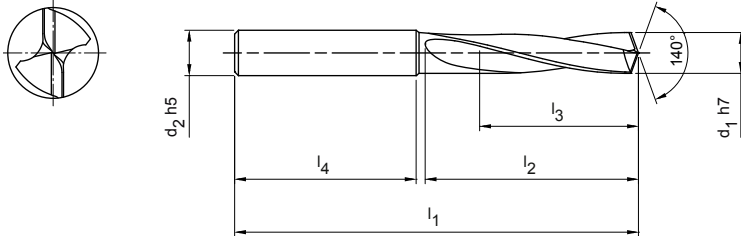

Lagerhaltige Vorzugsbaureihe in Schaftform HA

Baumaße						Schaftform HA	
d ₁ h7	d ₂ h5	l ₁	l ₂	l ₃	l ₄	Spezifikation	Bestell-Nr.
2,55	6	62	20	14	36	SCD140-0255-2-2-140HA03-HP809	31198190
2,60	6	62	20	14	36	SCD140-0260-2-2-140HA03-HP809	31198191
2,70	6	62	20	14	36	SCD140-0270-2-2-140HA03-HP809	31198192
2,80	6	62	20	14	36	SCD140-0280-2-2-140HA03-HP809	31198194
2,90	6	62	20	14	36	SCD140-0290-2-2-140HA03-HP809	31198196
3,00	6	62	20	14	36	SCD140-0300-2-2-140HA03-HP809	31151191
3,10	6	62	20	14	36	SCD140-0310-2-2-140HA03-HP809	31151192
3,20	6	62	20	14	36	SCD140-0320-2-2-140HA03-HP809	31151193
3,30	6	62	20	14	36	SCD140-0330-2-2-140HA03-HP809	31151194
3,40	6	62	20	14	36	SCD140-0340-2-2-140HA03-HP809	31151195
3,50	6	62	20	14	36	SCD140-0350-2-2-140HA03-HP809	31151196
3,60	6	62	20	14	36	SCD140-0360-2-2-140HA03-HP809	31151197
3,70	6	62	20	14	36	SCD140-0370-2-2-140HA03-HP809	31151198
3,80	6	66	24	17	36	SCD140-0380-2-2-140HA03-HP809	31151199
3,90	6	66	24	17	36	SCD140-0390-2-2-140HA03-HP809	31151330
4,00	6	66	24	17	36	SCD140-0400-2-2-140HA03-HP809	31151331
4,10	6	66	24	17	36	SCD140-0410-2-2-140HA03-HP809	31151332
4,20	6	66	24	17	36	SCD140-0420-2-2-140HA03-HP809	31151333
4,30	6	66	24	17	36	SCD140-0430-2-2-140HA03-HP809	31151334
4,40	6	66	24	17	36	SCD140-0440-2-2-140HA03-HP809	31151335
4,50	6	66	24	17	36	SCD140-0450-2-2-140HA03-HP809	31151336
4,60	6	66	24	17	36	SCD140-0460-2-2-140HA03-HP809	31151337
4,70	6	66	24	17	36	SCD140-0470-2-2-140HA03-HP809	31151339
4,80	6	66	28	20	36	SCD140-0480-2-2-140HA03-HP809	31151340
4,90	6	66	28	20	36	SCD140-0490-2-2-140HA03-HP809	31151341
5,00	6	66	28	20	36	SCD140-0500-2-2-140HA03-HP809	31151342
5,10	6	66	28	20	36	SCD140-0510-2-2-140HA03-HP809	31151343
5,20	6	66	28	20	36	SCD140-0520-2-2-140HA03-HP809	31151344
5,30	6	66	28	20	36	SCD140-0530-2-2-140HA03-HP809	31151345
5,40	6	66	28	20	36	SCD140-0540-2-2-140HA03-HP809	31151346
5,50	6	66	28	20	36	SCD140-0550-2-2-140HA03-HP809	31151347
5,55	6	66	28	20	36	SCD140-0555-2-2-140HA03-HP809	31151348
5,60	6	66	28	20	36	SCD140-0560-2-2-140HA03-HP809	31151349
5,70	6	66	28	20	36	SCD140-0570-2-2-140HA03-HP809	31151350
5,80	6	66	28	20	36	SCD140-0580-2-2-140HA03-HP809	31151351

MEGA-Drill-Hardened | Vollhartmetall-Spiralbohrer SCD140 (3xD)

Baumaße						Schaftform HA	
d ₁ h7	d ₂ h6	l ₁	l ₂	l ₃	l ₄	Spezifikation	Bestell-Nr.
5,90	6	66	28	20	36	SCD140-0590-2-2-140HA03-HP809	31151352
6,00	6	66	28	20	36	SCD140-0600-2-2-140HA03-HP809	31151353
6,10	8	79	34	24	36	SCD140-0610-2-2-140HA03-HP809	31151354
6,20	8	79	34	24	36	SCD140-0620-2-2-140HA03-HP809	31151355
6,30	8	79	34	24	36	SCD140-0630-2-2-140HA03-HP809	31151356
6,40	8	79	34	24	36	SCD140-0640-2-2-140HA03-HP809	31151357
6,50	8	79	34	24	36	SCD140-0650-2-2-140HA03-HP809	31151358
6,60	8	79	34	24	36	SCD140-0660-2-2-140HA03-HP809	31151359
6,70	8	79	34	24	36	SCD140-0670-2-2-140HA03-HP809	31151360
6,80	8	79	34	24	36	SCD140-0680-2-2-140HA03-HP809	31151361
6,90	8	79	34	24	36	SCD140-0690-2-2-140HA03-HP809	31151362
7,00	8	79	34	24	36	SCD140-0700-2-2-140HA03-HP809	31151363
7,10	8	79	41	29	36	SCD140-0710-2-2-140HA03-HP809	31151364
7,30	8	79	41	29	36	SCD140-0730-2-2-140HA03-HP809	31151366
7,40	8	79	41	29	36	SCD140-0740-2-2-140HA03-HP809	31151367
7,50	8	79	41	29	36	SCD140-0750-2-2-140HA03-HP809	31151368
7,80	8	79	41	29	36	SCD140-0780-2-2-140HA03-HP809	31151371
7,90	8	79	41	29	36	SCD140-0790-2-2-140HA03-HP809	31151372
8,00	8	79	41	29	36	SCD140-0800-2-2-140HA03-HP809	31151373
8,10	10	89	47	35	40	SCD140-0810-2-2-140HA03-HP809	31151374
8,20	10	89	47	35	40	SCD140-0820-2-2-140HA03-HP809	31151375
8,50	10	89	47	35	40	SCD140-0850-2-2-140HA03-HP809	31151378
8,60	10	89	47	35	40	SCD140-0860-2-2-140HA03-HP809	31151379
8,80	10	89	47	35	40	SCD140-0880-2-2-140HA03-HP809	31151381
9,00	10	89	47	35	40	SCD140-0900-2-2-140HA03-HP809	31151383
9,30	10	89	47	35	40	SCD140-0930-2-2-140HA03-HP809	31151386
9,50	10	89	47	35	40	SCD140-0950-2-2-140HA03-HP809	31151388
9,60	10	89	47	35	40	SCD140-0960-2-2-140HA03-HP809	31151389
9,70	10	89	47	35	40	SCD140-0970-2-2-140HA03-HP809	31151390
9,80	10	89	47	35	40	SCD140-0980-2-2-140HA03-HP809	31151391
10,00	10	89	47	35	40	SCD140-1000-2-2-140HA03-HP809	31151393
10,10	12	102	55	40	45	SCD140-1010-2-2-140HA03-HP809	31151394
10,20	12	102	55	40	45	SCD140-1020-2-2-140HA03-HP809	31151395
10,30	12	102	55	40	45	SCD140-1030-2-2-140HA03-HP809	31151396
10,40	12	102	55	40	45	SCD140-1040-2-2-140HA03-HP809	31151397
10,50	12	102	55	40	45	SCD140-1050-2-2-140HA03-HP809	31151398
11,00	12	102	55	40	45	SCD140-1100-2-2-140HA03-HP809	31151403
11,50	12	102	55	40	45	SCD140-1150-2-2-140HA03-HP809	31151408
11,80	12	102	55	40	45	SCD140-1180-2-2-140HA03-HP809	31151411
11,90	12	102	55	40	45	SCD140-1190-2-2-140HA03-HP809	31151412
12,00	12	102	55	40	45	SCD140-1200-2-2-140HA03-HP809	31151413
12,50	14	107	60	43	45	SCD140-1250-2-2-140HA03-HP809	31151415
12,80	14	107	60	43	45	SCD140-1280-2-2-140HA03-HP809	31151416
13,00	14	107	60	43	45	SCD140-1300-2-2-140HA03-HP809	31151417
13,50	14	107	60	43	45	SCD140-1350-2-2-140HA03-HP809	31151418
14,00	14	107	60	43	45	SCD140-1400-2-2-140HA03-HP809	31151420
14,20	16	115	65	45	48	SCD140-1420-2-2-140HA03-HP809	31151421
14,50	16	115	65	45	48	SCD140-1450-2-2-140HA03-HP809	31151422
14,80	16	115	65	45	48	SCD140-1480-2-2-140HA03-HP809	31151423
15,00	16	115	65	45	48	SCD140-1500-2-2-140HA03-HP809	31151424
15,50	16	115	65	45	48	SCD140-1550-2-2-140HA03-HP809	31151426
16,00	16	115	65	45	48	SCD140-1600-2-2-140HA03-HP809	31151428
17,50	18	123	73	51	48	SCD140-1750-2-2-140HA03-HP809	31151432

Fortsetzung auf nächster Seite.

MEGA-Drill-Hardened | Vollhartmetall-Spiralbohrer SCD140 (3xD)

Konfigurierbare Merkmale



Durchmesser:
Durchmesser in Abstufungen
von 0,01 mm frei wählbar



Schaftform:
Schaftform: HB | HE

Spezifikation:

SCD140-[Durchmesser]-2-2-140[Schaftform]03-HP809

Beispiel:

SCD140-0431-2-2-140HE03-HP809

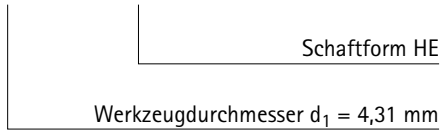

Abmessungen konfigurierbare Baureihe

d ₁ min.	d ₁ max.	d ₂ h6	l ₁	l ₂	l ₃	l ₄
2,55	3,79	6	62	20	14	36
3,80	4,79	6	66	24	17	36
4,80	6,00	6	66	28	20	36
6,01	7,00	8	79	34	24	36
7,01	8,00	8	79	41	29	36
8,01	10,00	10	89	47	35	40
10,01	12,00	12	102	55	40	45
12,01	14,00	14	107	60	43	45
14,01	16,00	16	115	65	45	48
16,01	18,00	18	123	73	51	48
18,01	20,00	20	131	79	55	50

Tritan-Drill-Steel

Vollhartmetall-Spiralbohrer
SCD661 (3xD), innere Kühlmittelzufuhr

Ausführung:
Bohrerdurchmesser: 4,00 – 20,00 mm
Bohrungstoleranz: ≥ IT 9
Schneidstoff: HP358
Schneidenanzahl: 3
Anzahl Führungsfasen: 3
Spitzenwinkel: 145°
Spiralwinkel: 30°

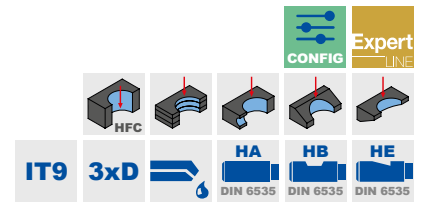
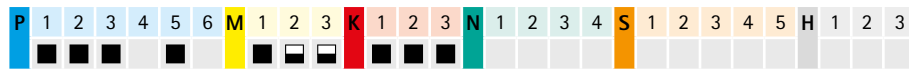
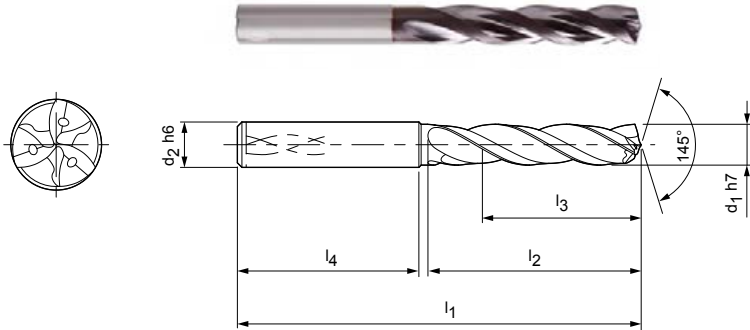

Lagerhaltige Vorzugsbaureihe in Schaftform HA

Baumaße						Schaftform HA	
d ₁ h7	d ₂ h6	l ₁	l ₂	l ₃	l ₄	Spezifikation	Bestell-Nr.
4,00	6	66	24	17	36	SCD661-0400-3-3-145HA03-HP358	30902036
4,10	6	66	24	17	36	SCD661-0410-3-3-145HA03-HP358	30902037
4,20	6	66	24	17	36	SCD661-0420-3-3-145HA03-HP358	30902038
4,30	6	66	24	17	36	SCD661-0430-3-3-145HA03-HP358	30902039
4,40	6	66	24	17	36	SCD661-0440-3-3-145HA03-HP358	30902040
4,50	6	66	24	17	36	SCD661-0450-3-3-145HA03-HP358	30902041
4,60	6	66	24	17	36	SCD661-0460-3-3-145HA03-HP358	30902042
4,65	6	66	24	17	36	SCD661-0465-3-3-145HA03-HP358	30902043
4,70	6	66	24	17	36	SCD661-0470-3-3-145HA03-HP358	30902044
4,80	6	66	28	20	36	SCD661-0480-3-3-145HA03-HP358	30902045
4,90	6	66	28	20	36	SCD661-0490-3-3-145HA03-HP358	30902046
5,00	6	66	28	20	36	SCD661-0500-3-3-145HA03-HP358	30902047
5,10	6	66	28	20	36	SCD661-0510-3-3-145HA03-HP358	30902048
5,20	6	66	28	20	36	SCD661-0520-3-3-145HA03-HP358	30902049
5,30	6	66	28	20	36	SCD661-0530-3-3-145HA03-HP358	30902050
5,40	6	66	28	20	36	SCD661-0540-3-3-145HA03-HP358	30902051
5,50	6	66	28	20	36	SCD661-0550-3-3-145HA03-HP358	30902052
5,55	6	66	28	20	36	SCD661-0555-3-3-145HA03-HP358	30902053
5,60	6	66	28	20	36	SCD661-0560-3-3-145HA03-HP358	30902054
5,70	6	66	28	20	36	SCD661-0570-3-3-145HA03-HP358	30902055
5,80	6	66	28	20	36	SCD661-0580-3-3-145HA03-HP358	30902056
5,90	6	66	28	20	36	SCD661-0590-3-3-145HA03-HP358	30902057
6,00	6	66	28	20	36	SCD661-0600-3-3-145HA03-HP358	30902058
6,10	8	79	34	24	36	SCD661-0610-3-3-145HA03-HP358	30902059
6,20	8	79	34	24	36	SCD661-0620-3-3-145HA03-HP358	30902060
6,30	8	79	34	24	36	SCD661-0630-3-3-145HA03-HP358	30902061
6,35	8	79	34	24	36	SCD661-0635-3-3-145HA03-HP358	31307522
6,40	8	79	34	24	36	SCD661-0640-3-3-145HA03-HP358	30902062
6,50	8	79	34	24	36	SCD661-0650-3-3-145HA03-HP358	30902063
6,60	8	79	34	24	36	SCD661-0660-3-3-145HA03-HP358	30902064
6,70	8	79	34	24	36	SCD661-0670-3-3-145HA03-HP358	30902065
6,80	8	79	34	24	36	SCD661-0680-3-3-145HA03-HP358	30902066
6,90	8	79	34	24	36	SCD661-0690-3-3-145HA03-HP358	30902067
7,00	8	79	34	24	36	SCD661-0700-3-3-145HA03-HP358	30902068
7,10	8	79	41	29	36	SCD661-0710-3-3-145HA03-HP358	30902069

Tritan-Drill-Steel | Vollhartmetall-Spiralbohrer SCD661 (3xD), innere Kühlmittelzufuhr

Baumaße						Schaftform HA	
d ₁ h7	d ₂ h6	l ₁	l ₂	l ₃	l ₄	Spezifikation	Bestell-Nr.
7,20	8	79	41	29	36	SCD661-0720-3-3-145HA03-HP358	30902070
7,30	8	79	41	29	36	SCD661-0730-3-3-145HA03-HP358	30902071
7,40	8	79	41	29	36	SCD661-0740-3-3-145HA03-HP358	30902072
7,45	8	79	41	29	36	SCD661-0745-3-3-145HA03-HP358	30902073
7,50	8	79	41	29	36	SCD661-0750-3-3-145HA03-HP358	30902074
7,60	8	79	41	29	36	SCD661-0760-3-3-145HA03-HP358	30902075
7,70	8	79	41	29	36	SCD661-0770-3-3-145HA03-HP358	30902076
7,80	8	79	41	29	36	SCD661-0780-3-3-145HA03-HP358	30902077
7,90	8	79	41	29	36	SCD661-0790-3-3-145HA03-HP358	30902078
8,00	8	79	41	29	36	SCD661-0800-3-3-145HA03-HP358	30902079
8,10	10	89	47	35	40	SCD661-0810-3-3-145HA03-HP358	30902080
8,20	10	89	47	35	40	SCD661-0820-3-3-145HA03-HP358	30902081
8,30	10	89	47	35	40	SCD661-0830-3-3-145HA03-HP358	30902082
8,40	10	89	47	35	40	SCD661-0840-3-3-145HA03-HP358	30902083
8,50	10	89	47	35	40	SCD661-0850-3-3-145HA03-HP358	30902084
8,60	10	89	47	35	40	SCD661-0860-3-3-145HA03-HP358	30902085
8,70	10	89	47	35	40	SCD661-0870-3-3-145HA03-HP358	30902086
8,80	10	89	47	35	40	SCD661-0880-3-3-145HA03-HP358	30902087
9,00	10	89	47	35	40	SCD661-0900-3-3-145HA03-HP358	30902089
9,10	10	89	47	35	40	SCD661-0910-3-3-145HA03-HP358	30902090
9,20	10	89	47	35	40	SCD661-0920-3-3-145HA03-HP358	30902091
9,30	10	89	47	35	40	SCD661-0930-3-3-145HA03-HP358	30902092
9,35	10	89	47	35	40	SCD661-0935-3-3-145HA03-HP358	31307523
9,40	10	89	47	35	40	SCD661-0940-3-3-145HA03-HP358	30902093
9,50	10	89	47	35	40	SCD661-0950-3-3-145HA03-HP358	30902094
9,60	10	89	47	35	40	SCD661-0960-3-3-145HA03-HP358	30902095
9,70	10	89	47	35	40	SCD661-0970-3-3-145HA03-HP358	30902096
9,80	10	89	47	35	40	SCD661-0980-3-3-145HA03-HP358	30902097
9,90	10	89	47	35	40	SCD661-0990-3-3-145HA03-HP358	30902098
10,00	10	89	47	35	40	SCD661-1000-3-3-145HA03-HP358	30902099
10,10	12	102	55	40	45	SCD661-1010-3-3-145HA03-HP358	30902100
10,20	12	102	55	40	45	SCD661-1020-3-3-145HA03-HP358	30902101
10,30	12	102	55	40	45	SCD661-1030-3-3-145HA03-HP358	30902102
10,40	12	102	55	40	45	SCD661-1040-3-3-145HA03-HP358	30902103
10,50	12	102	55	40	45	SCD661-1050-3-3-145HA03-HP358	30902104
10,80	12	102	55	40	45	SCD661-1080-3-3-145HA03-HP358	30902107
10,90	12	102	55	40	45	SCD661-1090-3-3-145HA03-HP358	30902108
11,00	12	102	55	40	45	SCD661-1100-3-3-145HA03-HP358	30902109
11,10	12	102	55	40	45	SCD661-1110-3-3-145HA03-HP358	30902110
11,20	12	102	55	40	45	SCD661-1120-3-3-145HA03-HP358	30902111
11,30	12	102	55	40	45	SCD661-1130-3-3-145HA03-HP358	30902112
11,40	12	102	55	40	45	SCD661-1140-3-3-145HA03-HP358	30902113
11,50	12	102	55	40	45	SCD661-1150-3-3-145HA03-HP358	30902114
11,60	12	102	55	40	45	SCD661-1160-3-3-145HA03-HP358	30902115
11,70	12	102	55	40	45	SCD661-1170-3-3-145HA03-HP358	30902116
11,80	12	102	55	40	45	SCD661-1180-3-3-145HA03-HP358	30902117
11,90	12	102	55	40	45	SCD661-1190-3-3-145HA03-HP358	30902118
12,00	12	102	55	40	45	SCD661-1200-3-3-145HA03-HP358	30902119
12,20	14	107	60	43	45	SCD661-1220-3-3-145HA03-HP358	30902120
12,23	14	107	60	43	45	SCD661-1223-3-3-145HA03-HP358	31271441
12,50	14	107	60	43	45	SCD661-1250-3-3-145HA03-HP358	30902121
12,70	14	107	60	43	45	SCD661-1270-3-3-145HA03-HP358	31307524
13,00	14	107	60	43	45	SCD661-1300-3-3-145HA03-HP358	30902123
13,50	14	107	60	43	45	SCD661-1350-3-3-145HA03-HP358	30902125
13,80	14	107	60	43	45	SCD661-1380-3-3-145HA03-HP358	30902126
14,00	14	107	60	43	45	SCD661-1400-3-3-145HA03-HP358	30902127
14,20	16	115	65	45	48	SCD661-1420-3-3-145HA03-HP358	30902128

Tritan-Drill-Steel | Vollhartmetall-Spiralbohrer SCD661 (3xD), innere Kühlmittelzufuhr

Baumaße						Schaftform HA	
d ₁ h7	d ₂ h6	l ₁	l ₂	l ₃	l ₄	Spezifikation	Bestell-Nr.
14,50	16	115	65	45	48	SCD661-1450-3-3-145HA03-HP358	30902129
14,80	16	115	65	45	48	SCD661-1480-3-3-145HA03-HP358	30902130
15,00	16	115	65	45	48	SCD661-1500-3-3-145HA03-HP358	30902131
15,20	16	115	65	45	48	SCD661-1520-3-3-145HA03-HP358	30902132
15,50	16	115	65	45	48	SCD661-1550-3-3-145HA03-HP358	30902133
15,80	16	115	65	45	48	SCD661-1580-3-3-145HA03-HP358	30902134
16,00	16	115	65	45	48	SCD661-1600-3-3-145HA03-HP358	30902135
16,20	18	123	73	51	48	SCD661-1620-3-3-145HA03-HP358	30902136
16,50	18	123	73	51	48	SCD661-1650-3-3-145HA03-HP358	30902137
17,00	18	123	73	51	48	SCD661-1700-3-3-145HA03-HP358	30902139
17,35	18	123	73	51	48	SCD661-1735-3-3-145HA03-HP358	31307525
17,50	18	123	73	51	48	SCD661-1750-3-3-145HA03-HP358	30902141
17,80	18	123	73	51	48	SCD661-1780-3-3-145HA03-HP358	30902142
18,00	18	123	73	51	48	SCD661-1800-3-3-145HA03-HP358	30902143
18,50	20	131	79	55	50	SCD661-1850-3-3-145HA03-HP358	30902145
18,80	20	131	79	55	50	SCD661-1880-3-3-145HA03-HP358	30902146
19,00	20	131	79	55	50	SCD661-1900-3-3-145HA03-HP358	30902147
19,50	20	131	79	55	50	SCD661-1950-3-3-145HA03-HP358	30902149
20,00	20	131	79	55	50	SCD661-2000-3-3-145HA03-HP358	30902151

Konfigurierbare Merkmale



Durchmesser:
Durchmesser in Abstufungen
von 0,01 mm frei wählbar



Schaftform:
Schaftform: HB | HE

Spezifikation:

SCD661-[Durchmesser]-3-3-140[Schaftform]03-HP358

Abmessungen konfigurierbare Baureihe

d ₁ min.	d ₁ max.	d ₂ h6	l ₁	l ₂	l ₃	l ₄
4,00	4,70	6	66	24	17	36
4,71	6,00	6	66	28	20	36
6,01	7,00	8	79	34	24	36
7,01	8,00	8	79	41	29	36
8,01	10,00	10	89	47	35	40
10,01	12,00	12	102	55	40	45
12,01	14,00	14	107	60	43	45
14,01	16,00	16	115	65	45	48
16,01	18,00	18	123	73	51	48
18,01	20,00	20	131	79	55	50

Beispiel:

SCD661-0431-3-3-140HE03-HP358

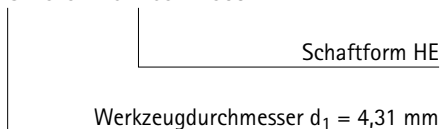

Maßangaben in mm.

Schnittwertempfehlung siehe Kapitelende.

Sonderausführungen und andere Beschichtungen auf Anfrage.

Tritan-Drill-Steel

Vollhartmetall-Spiralbohrer
SCD661 (5xD), innere Kühlmittelzufuhr

Ausführung:

Bohrerdurchmesser: 4,00 – 20,00 mm
Bohrungstoleranz: \geq IT 9
Schneidstoff: HP358
Schneidenanzahl: 3
Anzahl Führungsfasen: 3
Spitzenwinkel: 145°
Spiralwinkel: 30°

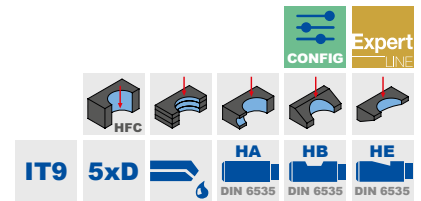
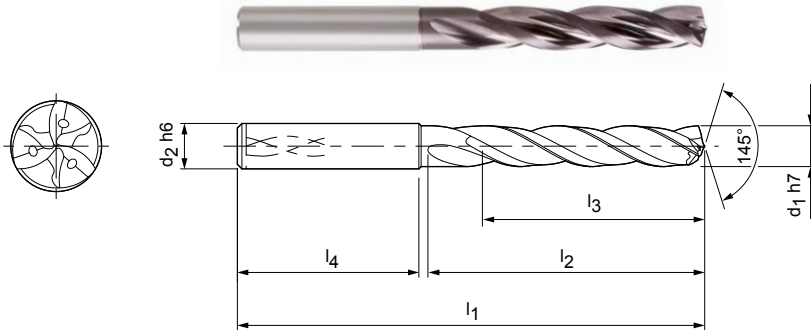

Lagerhaltige Vorzugsbaureihe in Schaftform HA

Baumaße						Schaftform HA	
d ₁ h7	d ₂ h6	l ₁	l ₂	l ₃	l ₄	Spezifikation	Bestell-Nr.
4,00	6	74	36	29	36	SCD661-0400-3-3-145HA05-HP358	30902152
4,10	6	74	36	29	36	SCD661-0410-3-3-145HA05-HP358	30902153
4,20	6	74	36	29	36	SCD661-0420-3-3-145HA05-HP358	30902154
4,30	6	74	36	29	36	SCD661-0430-3-3-145HA05-HP358	30902155
4,40	6	74	36	29	36	SCD661-0440-3-3-145HA05-HP358	30902156
4,50	6	74	36	29	36	SCD661-0450-3-3-145HA05-HP358	30902157
4,60	6	74	36	29	36	SCD661-0460-3-3-145HA05-HP358	30902158
4,65	6	74	36	29	36	SCD661-0465-3-3-145HA05-HP358	30902159
4,70	6	74	36	29	36	SCD661-0470-3-3-145HA05-HP358	30902160
4,80	6	82	44	35	36	SCD661-0480-3-3-145HA05-HP358	30902161
4,90	6	82	44	35	36	SCD661-0490-3-3-145HA05-HP358	30902162
5,00	6	82	44	35	36	SCD661-0500-3-3-145HA05-HP358	30902163
5,10	6	82	44	35	36	SCD661-0510-3-3-145HA05-HP358	30902164
5,20	6	82	44	35	36	SCD661-0520-3-3-145HA05-HP358	30902165
5,30	6	82	44	35	36	SCD661-0530-3-3-145HA05-HP358	30902166
5,40	6	82	44	35	36	SCD661-0540-3-3-145HA05-HP358	30902167
5,50	6	82	44	35	36	SCD661-0550-3-3-145HA05-HP358	30902168
5,55	6	82	44	35	36	SCD661-0555-3-3-145HA05-HP358	30902169
5,60	6	82	44	35	36	SCD661-0560-3-3-145HA05-HP358	30902170
5,70	6	82	44	35	36	SCD661-0570-3-3-145HA05-HP358	30902171
5,80	6	82	44	35	36	SCD661-0580-3-3-145HA05-HP358	30902172
5,90	6	82	44	35	36	SCD661-0590-3-3-145HA05-HP358	30902173
6,00	6	82	44	35	36	SCD661-0600-3-3-145HA05-HP358	30902174
6,05	8	91	53	43	36	SCD661-0605-3-3-145HA05-HP358	31307526
6,10	8	91	53	43	36	SCD661-0610-3-3-145HA05-HP358	30902175
6,20	8	91	53	43	36	SCD661-0620-3-3-145HA05-HP358	30902176
6,30	8	91	53	43	36	SCD661-0630-3-3-145HA05-HP358	30902177
6,40	8	91	53	43	36	SCD661-0640-3-3-145HA05-HP358	30902178
6,50	8	91	53	43	36	SCD661-0650-3-3-145HA05-HP358	30902179
6,60	8	91	53	43	36	SCD661-0660-3-3-145HA05-HP358	30902180
6,80	8	91	53	43	36	SCD661-0680-3-3-145HA05-HP358	30902182
6,90	8	91	53	43	36	SCD661-0690-3-3-145HA05-HP358	30902183
7,00	8	91	53	43	36	SCD661-0700-3-3-145HA05-HP358	30902184
7,10	8	91	53	43	36	SCD661-0710-3-3-145HA05-HP358	30902185
7,20	8	91	53	43	36	SCD661-0720-3-3-145HA05-HP358	30902186

Tritan-Drill-Steel | Vollhartmetall-Spiralbohrer SCD661 (5xD), innere Kühlmittelzufuhr

Baumaße						Schaftform HA	
d ₁ h7	d ₂ h6	l ₁	l ₂	l ₃	l ₄	Spezifikation	Bestell-Nr.
7,30	8	91	53	43	36	SCD661-0730-3-3-145HA05-HP358	30902187
7,40	8	91	53	43	36	SCD661-0740-3-3-145HA05-HP358	30902188
7,45	8	91	53	43	36	SCD661-0745-3-3-145HA05-HP358	30902189
7,50	8	91	53	43	36	SCD661-0750-3-3-145HA05-HP358	30902190
7,60	8	91	53	43	36	SCD661-0760-3-3-145HA05-HP358	30902191
7,70	8	91	53	43	36	SCD661-0770-3-3-145HA05-HP358	30902192
7,80	8	91	53	43	36	SCD661-0780-3-3-145HA05-HP358	30902193
7,90	8	91	53	43	36	SCD661-0790-3-3-145HA05-HP358	30902194
8,00	8	91	53	43	36	SCD661-0800-3-3-145HA05-HP358	30902195
8,10	10	103	61	49	40	SCD661-0810-3-3-145HA05-HP358	30902196
8,20	10	103	61	49	40	SCD661-0820-3-3-145HA05-HP358	30902197
8,30	10	103	61	49	40	SCD661-0830-3-3-145HA05-HP358	30902198
8,40	10	103	61	49	40	SCD661-0840-3-3-145HA05-HP358	30902199
8,50	10	103	61	49	40	SCD661-0850-3-3-145HA05-HP358	30902200
8,60	10	103	61	49	40	SCD661-0860-3-3-145HA05-HP358	30902201
8,70	10	103	61	49	40	SCD661-0870-3-3-145HA05-HP358	30902202
8,80	10	103	61	49	40	SCD661-0880-3-3-145HA05-HP358	30902203
8,90	10	103	61	49	40	SCD661-0890-3-3-145HA05-HP358	30902204
9,00	10	103	61	49	40	SCD661-0900-3-3-145HA05-HP358	30902205
9,10	10	103	61	49	40	SCD661-0910-3-3-145HA05-HP358	30902206
9,20	10	103	61	49	40	SCD661-0920-3-3-145HA05-HP358	30902207
9,30	10	103	61	49	40	SCD661-0930-3-3-145HA05-HP358	30902208
9,35	10	103	61	49	40	SCD661-0935-3-3-145HA05-HP358	30902209
9,40	10	103	61	49	40	SCD661-0940-3-3-145HA05-HP358	30902210
9,50	10	103	61	49	40	SCD661-0950-3-3-145HA05-HP358	30902211
9,70	10	103	61	49	40	SCD661-0970-3-3-145HA05-HP358	30902214
9,80	10	103	61	49	40	SCD661-0980-3-3-145HA05-HP358	30902215
9,90	10	103	61	49	40	SCD661-0990-3-3-145HA05-HP358	30902216
10,00	10	103	61	49	40	SCD661-1000-3-3-145HA05-HP358	30902217
10,10	12	118	71	56	45	SCD661-1010-3-3-145HA05-HP358	30902218
10,20	12	118	71	56	45	SCD661-1020-3-3-145HA05-HP358	30902219
10,30	12	118	71	56	45	SCD661-1030-3-3-145HA05-HP358	30902220
10,40	12	118	71	56	45	SCD661-1040-3-3-145HA05-HP358	30902221
10,50	12	118	71	56	45	SCD661-1050-3-3-145HA05-HP358	30902222
10,80	12	118	71	56	45	SCD661-1080-3-3-145HA05-HP358	30902225
11,00	12	118	71	56	45	SCD661-1100-3-3-145HA05-HP358	30902227
11,10	12	118	71	56	45	SCD661-1110-3-3-145HA05-HP358	30902228
11,20	12	118	71	56	45	SCD661-1120-3-3-145HA05-HP358	30902229
11,30	12	118	71	56	45	SCD661-1130-3-3-145HA05-HP358	30902230
11,40	12	118	71	56	45	SCD661-1140-3-3-145HA05-HP358	30902231
11,50	12	118	71	56	45	SCD661-1150-3-3-145HA05-HP358	30902232
11,80	12	118	71	56	45	SCD661-1180-3-3-145HA05-HP358	30902235
11,90	12	118	71	56	45	SCD661-1190-3-3-145HA05-HP358	30902236
12,00	12	118	71	56	45	SCD661-1200-3-3-145HA05-HP358	30902237
12,20	14	124	77	60	45	SCD661-1220-3-3-145HA05-HP358	30902238
12,50	14	124	77	60	45	SCD661-1250-3-3-145HA05-HP358	30902239
12,80	14	124	77	60	45	SCD661-1280-3-3-145HA05-HP358	30902240
13,00	14	124	77	60	45	SCD661-1300-3-3-145HA05-HP358	30902241
13,50	14	124	77	60	45	SCD661-1350-3-3-145HA05-HP358	30902243
13,80	14	124	77	60	45	SCD661-1380-3-3-145HA05-HP358	30902244
14,00	14	124	77	60	45	SCD661-1400-3-3-145HA05-HP358	30902245
14,20	16	133	83	63	48	SCD661-1420-3-3-145HA05-HP358	30902246
14,50	16	133	83	63	48	SCD661-1450-3-3-145HA05-HP358	30902247
14,80	16	133	83	63	48	SCD661-1480-3-3-145HA05-HP358	30902248
15,00	16	133	83	63	48	SCD661-1500-3-3-145HA05-HP358	30902249
15,10	16	133	83	63	48	SCD661-1510-3-3-145HA05-HP358	30902250
15,20	16	133	83	63	48	SCD661-1520-3-3-145HA05-HP358	30902251

Fortsetzung auf nächster Seite.

Tritan-Drill-Steel | Vollhartmetall-Spiralbohrer SCD661 (5xD), innere Kühlmittelzufuhr

Baumaße						Schaftform HA	
d ₁ h7	d ₂ h6	l ₁	l ₂	l ₃	l ₄	Spezifikation	Bestell-Nr.
15,25	16	133	83	63	48	SCD661-1525-3-3-145HA05-HP358	30902252
15,50	16	133	83	63	48	SCD661-1550-3-3-145HA05-HP358	30902253
15,80	16	133	83	63	48	SCD661-1580-3-3-145HA05-HP358	30902254
16,00	16	133	83	63	48	SCD661-1600-3-3-145HA05-HP358	30902255
16,20	18	143	93	71	48	SCD661-1620-3-3-145HA05-HP358	30902256
16,50	18	143	93	71	48	SCD661-1650-3-3-145HA05-HP358	30902257
16,80	18	143	93	71	48	SCD661-1680-3-3-145HA05-HP358	30902258
17,00	18	143	93	71	48	SCD661-1700-3-3-145HA05-HP358	30902259
17,50	18	143	93	71	48	SCD661-1750-3-3-145HA05-HP358	30902261
18,00	18	143	93	71	48	SCD661-1800-3-3-145HA05-HP358	30902263
18,50	20	153	101	77	50	SCD661-1850-3-3-145HA05-HP358	30902265
18,80	20	153	101	77	50	SCD661-1880-3-3-145HA05-HP358	30902266
19,00	20	153	101	77	50	SCD661-1900-3-3-145HA05-HP358	30902267
19,50	20	153	101	77	50	SCD661-1950-3-3-145HA05-HP358	30902269
19,80	20	153	101	77	50	SCD661-1980-3-3-145HA05-HP358	30902270
20,00	20	153	101	77	50	SCD661-2000-3-3-145HA05-HP358	30902271

Konfigurierbare Merkmale



Durchmesser:
Durchmesser in Abstufungen
von 0,01 mm frei wählbar



Schaftform:
Schaftform: HB | HE

Spezifikation:

SCD661-[Durchmesser]-3-3-145[Schaftform]05-HP358

Abmessungen konfigurierbare Baureihe

d ₁ min.	d ₁ max.	d ₂ h6	l ₁	l ₂	l ₃	l ₄
4,00	4,70	6	74	36	29	36
4,71	6,00	6	82	44	35	36
6,01	8,00	8	91	53	43	36
8,01	10,00	10	103	61	49	40
10,01	12,00	12	118	71	56	45
12,01	14,00	14	124	77	60	45
14,01	16,00	16	133	83	63	48
16,01	18,00	18	143	93	71	48
18,01	20,00	20	153	101	77	50

Beispiel:

SCD661-0431-3-3-145HE05-HP358

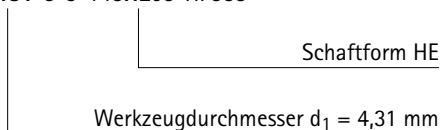

Maßangaben in mm.

Schnittwertempfehlung siehe Kapitelende.

Sonderausführungen und andere Beschichtungen auf Anfrage.

Tritan-Drill-Steel

Vollhartmetall-Spiralbohrer
SCD661 (8xD), innere Kühlmittelzufuhr

Ausführung:

Bohrerdurchmesser: 4,00 – 20,00 mm
Bohrungstoleranz: \geq IT 9
Schneidstoff: HP358
Schneidenanzahl: 3
Anzahl Führungsfasen: 3
Spitzenwinkel: 140°
Spiralwinkel: 30°

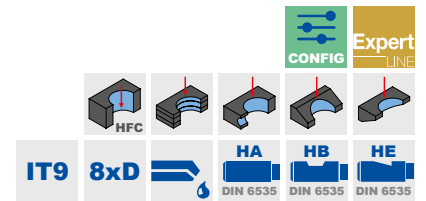
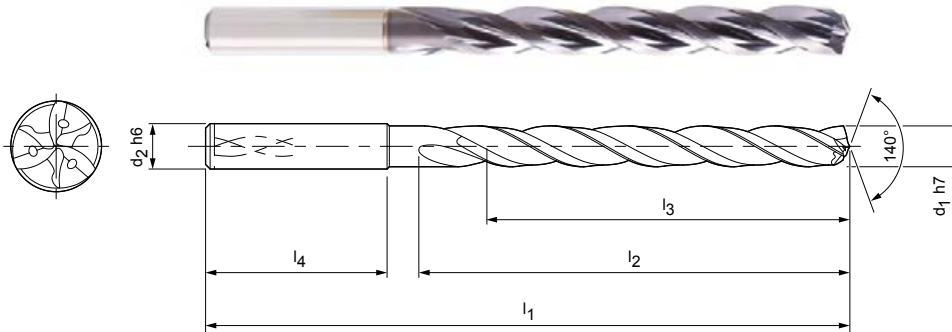

Lagerhaltige Vorzugsbaureihe in Schaftform HA

Baumaße						Schaftform HA	
d ₁ h7	d ₂ h6	l ₁	l ₂	l ₃	l ₄	Spezifikation	Bestell-Nr.
4,00	6	81	43	36	36	SCD661-0400-3-3-140HA08-HP358	30902272
4,10	6	81	43	36	36	SCD661-0410-3-3-140HA08-HP358	30902273
4,20	6	81	43	36	36	SCD661-0420-3-3-140HA08-HP358	30902274
4,30	6	81	43	36	36	SCD661-0430-3-3-140HA08-HP358	30902275
4,50	6	81	43	36	36	SCD661-0450-3-3-140HA08-HP358	30902277
4,60	6	81	43	36	36	SCD661-0460-3-3-140HA08-HP358	30902278
4,70	6	81	43	36	36	SCD661-0470-3-3-140HA08-HP358	30902279
4,80	6	95	57	48	36	SCD661-0480-3-3-140HA08-HP358	30902280
5,00	6	95	57	48	36	SCD661-0500-3-3-140HA08-HP358	30902282
5,10	6	95	57	48	36	SCD661-0510-3-3-140HA08-HP358	30902283
5,20	6	95	57	48	36	SCD661-0520-3-3-140HA08-HP358	30902284
5,40	6	95	57	48	36	SCD661-0540-3-3-140HA08-HP358	30902286
5,50	6	95	57	48	36	SCD661-0550-3-3-140HA08-HP358	30902287
5,60	6	95	57	48	36	SCD661-0560-3-3-140HA08-HP358	30902288
5,80	6	95	57	48	36	SCD661-0580-3-3-140HA08-HP358	30902290
5,90	6	95	57	48	36	SCD661-0590-3-3-140HA08-HP358	30902291
6,00	6	95	57	48	36	SCD661-0600-3-3-140HA08-HP358	30902292
6,10	8	114	76	64	36	SCD661-0610-3-3-140HA08-HP358	30902293
6,50	8	114	76	64	36	SCD661-0650-3-3-140HA08-HP358	30902297
6,60	8	114	76	64	36	SCD661-0660-3-3-140HA08-HP358	30902298
6,80	8	114	76	64	36	SCD661-0680-3-3-140HA08-HP358	30902300
6,90	8	114	76	64	36	SCD661-0690-3-3-140HA08-HP358	30902301
7,00	8	114	76	64	36	SCD661-0700-3-3-140HA08-HP358	30902302
7,50	8	114	76	64	36	SCD661-0750-3-3-140HA08-HP358	30902307
7,80	8	114	76	64	36	SCD661-0780-3-3-140HA08-HP358	30902310
7,90	8	114	76	64	36	SCD661-0790-3-3-140HA08-HP358	30902311
8,00	8	114	76	64	36	SCD661-0800-3-3-140HA08-HP358	30902312
8,10	10	142	95	80	40	SCD661-0810-3-3-140HA08-HP358	30902313
8,20	10	142	95	80	40	SCD661-0820-3-3-140HA08-HP358	30902314
8,50	10	142	95	80	40	SCD661-0850-3-3-140HA08-HP358	30902317
8,60	10	142	95	80	40	SCD661-0860-3-3-140HA08-HP358	30902318
8,80	10	142	95	80	40	SCD661-0880-3-3-140HA08-HP358	30902320
9,00	10	142	95	80	40	SCD661-0900-3-3-140HA08-HP358	30902322
9,10	10	142	95	80	40	SCD661-0910-3-3-140HA08-HP358	30902323
9,50	10	142	95	80	40	SCD661-0950-3-3-140HA08-HP358	30902327

Fortsetzung auf nächster Seite.

Tritan-Drill-Steel | Vollhartmetall-Spiralbohrer SCD661 (8xD), innere Kühlmittelzufuhr

Baumaße						Schaftform HA	
d ₁ h7	d ₂ h6	l ₁	l ₂	l ₃	l ₄	Spezifikation	Bestell-Nr.
9,80	10	142	95	80	40	SCD661-0980-3-3-140HA08-HP358	30902330
10,00	10	142	95	80	40	SCD661-1000-3-3-140HA08-HP358	30902332
10,20	12	162	114	96	45	SCD661-1020-3-3-140HA08-HP358	30902334
10,30	12	162	114	96	45	SCD661-1030-3-3-140HA08-HP358	30902335
10,50	12	162	114	96	45	SCD661-1050-3-3-140HA08-HP358	30902337
11,00	12	162	114	96	45	SCD661-1100-3-3-140HA08-HP358	30902342
11,50	12	162	114	96	45	SCD661-1150-3-3-140HA08-HP358	30902347
11,80	12	162	114	96	45	SCD661-1180-3-3-140HA08-HP358	30902350
11,90	12	162	114	96	45	SCD661-1190-3-3-140HA08-HP358	30902351
12,00	12	162	114	96	45	SCD661-1200-3-3-140HA08-HP358	30902352
12,20	14	178	133	112	45	SCD661-1220-3-3-140HA08-HP358	30902353
12,50	14	178	133	112	45	SCD661-1250-3-3-140HA08-HP358	30902354
13,00	14	178	133	112	45	SCD661-1300-3-3-140HA08-HP358	30902356
13,50	14	178	133	112	45	SCD661-1350-3-3-140HA08-HP358	30902358
13,80	14	178	133	112	45	SCD661-1380-3-3-140HA08-HP358	30902359
14,00	14	178	133	112	45	SCD661-1400-3-3-140HA08-HP358	30902360
14,20	16	203	152	128	48	SCD661-1420-3-3-140HA08-HP358	30902361
14,50	16	203	152	128	48	SCD661-1450-3-3-140HA08-HP358	30902362
15,00	16	203	152	128	48	SCD661-1500-3-3-140HA08-HP358	30902364
15,50	16	203	152	128	48	SCD661-1550-3-3-140HA08-HP358	30902366
15,80	16	203	152	128	48	SCD661-1580-3-3-140HA08-HP358	30902367
16,00	16	203	152	128	48	SCD661-1600-3-3-140HA08-HP358	30902368
17,00	18	222	171	144	48	SCD661-1700-3-3-140HA08-HP358	30902372
17,50	18	222	171	144	48	SCD661-1750-3-3-140HA08-HP358	30902374
18,00	18	222	171	144	48	SCD661-1800-3-3-140HA08-HP358	30902376
18,50	20	243	190	160	50	SCD661-1850-3-3-140HA08-HP358	30902378
19,00	20	243	190	160	50	SCD661-1900-3-3-140HA08-HP358	30902380
19,20	20	243	190	160	50	SCD661-1920-3-3-140HA08-HP358	30902381
19,50	20	243	190	160	50	SCD661-1950-3-3-140HA08-HP358	30902382
20,00	20	243	190	160	50	SCD661-2000-3-3-140HA08-HP358	30902384

Konfigurierbare Merkmale



Durchmesser:
Durchmesser in Abstufungen
von 0,01 mm frei wählbar



Schaftform:
Schaftform: HB | HE

Spezifikation:

SCD661-[Durchmesser]-3-3-140[Schaftform]08-HP358

Abmessungen konfigurierbare Baureihe

d ₁ min.	d ₁ max.	d ₂ h6	l ₁	l ₂	l ₃	l ₄
4,00	4,70	6	81	43	36	36
4,71	6,00	6	95	57	48	36
6,01	8,00	8	114	76	64	36
8,01	10,00	10	142	95	80	40
10,01	12,00	12	162	114	96	45
12,01	14,00	14	178	133	112	45
14,01	16,00	16	203	152	128	48
16,01	18,00	18	222	171	144	48
18,01	20,00	20	243	190	160	50

Beispiel:

SCD661-0431-3-3-140HE08-HP358

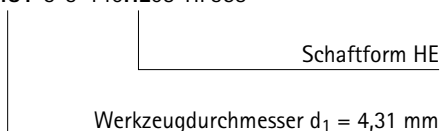

Maßangaben in mm.

Schnittwertempfehlung siehe Kapitelende.

Sonderausführungen und andere Beschichtungen auf Anfrage.

Tritan-Drill-Steel

Vollhartmetall-Spiralbohrer
SCD661 (12xD), innere Kühlmittelzufuhr

Ausführung:

Bohrerdurchmesser: 4,00 – 20,00 mm
Bohrungstoleranz: \geq IT 9
Schneidstoff: HP358
Schneidenanzahl: 3
Anzahl Führungsfasen: 3
Spitzenwinkel: 140°
Spiralwinkel: 30°

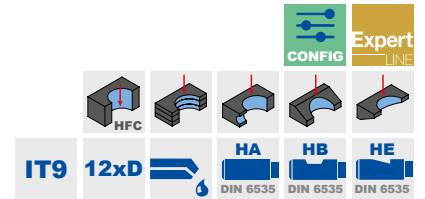
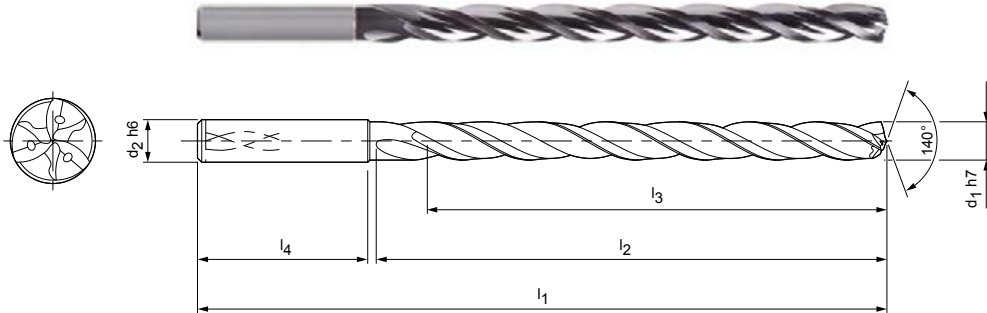

Lagerhaltige Vorzugsbaureihe in Schaftform HA

Baumaße						Schaftform HA	
d_1 h7	d_2 h6	l_1	l_2	l_3	l_4	Spezifikation	Bestell-Nr.
4,00	6	102	64	58	36	SCD661-0400-3-3-140HA12-HP358	30902385
4,10	6	102	64	58	36	SCD661-0410-3-3-140HA12-HP358	30902386
4,20	6	102	64	58	36	SCD661-0420-3-3-140HA12-HP358	30902387
4,30	6	102	64	58	36	SCD661-0430-3-3-140HA12-HP358	30902388
4,50	6	102	64	58	36	SCD661-0450-3-3-140HA12-HP358	30902390
4,60	6	102	64	58	36	SCD661-0460-3-3-140HA12-HP358	30902391
4,80	6	116	78	70	36	SCD661-0480-3-3-140HA12-HP358	30902393
5,00	6	116	78	70	36	SCD661-0500-3-3-140HA12-HP358	30902395
5,10	6	116	78	70	36	SCD661-0510-3-3-140HA12-HP358	30902396
5,20	6	116	78	70	36	SCD661-0520-3-3-140HA12-HP358	30902397
5,40	6	116	78	70	36	SCD661-0540-3-3-140HA12-HP358	30902399
5,50	6	116	78	70	36	SCD661-0550-3-3-140HA12-HP358	30902400
5,80	6	116	78	70	36	SCD661-0580-3-3-140HA12-HP358	30902403
5,90	6	116	78	70	36	SCD661-0590-3-3-140HA12-HP358	30902404
6,00	6	116	78	70	36	SCD661-0600-3-3-140HA12-HP358	30902405
6,10	8	146	108	94	36	SCD661-0610-3-3-140HA12-HP358	30902406
6,50	8	146	108	94	36	SCD661-0650-3-3-140HA12-HP358	30902410
6,80	8	146	108	94	36	SCD661-0680-3-3-140HA12-HP358	30902413
7,00	8	146	108	94	36	SCD661-0700-3-3-140HA12-HP358	30902415
7,50	8	146	108	94	36	SCD661-0750-3-3-140HA12-HP358	30902420
7,80	8	146	108	94	36	SCD661-0780-3-3-140HA12-HP358	30902423
7,90	8	146	108	94	36	SCD661-0790-3-3-140HA12-HP358	30902424
8,00	8	146	108	94	36	SCD661-0800-3-3-140HA12-HP358	30902425
8,20	10	162	120	110	40	SCD661-0820-3-3-140HA12-HP358	30902427
8,40	10	162	120	110	40	SCD661-0840-3-3-140HA12-HP358	30902429
8,50	10	162	120	110	40	SCD661-0850-3-3-140HA12-HP358	30902430
8,80	10	162	120	110	40	SCD661-0880-3-3-140HA12-HP358	30902433
9,00	10	162	120	110	40	SCD661-0900-3-3-140HA12-HP358	30902435
9,50	10	162	120	110	40	SCD661-0950-3-3-140HA12-HP358	30902440
9,60	10	162	120	110	40	SCD661-0960-3-3-140HA12-HP358	30902441
9,80	10	162	120	110	40	SCD661-0980-3-3-140HA12-HP358	30902443
10,00	10	162	120	110	40	SCD661-1000-3-3-140HA12-HP358	30902445
10,20	12	204	156	142	45	SCD661-1020-3-3-140HA12-HP358	30902447
10,30	12	204	156	142	45	SCD661-1030-3-3-140HA12-HP358	30902448
10,50	12	204	156	142	45	SCD661-1050-3-3-140HA12-HP358	30902450

Fortsetzung auf nächster Seite.

Tritan-Drill-Steel | Vollhartmetall-Spiralbohrer SCD661 (12xD), innere Kühlmittelzufuhr

Baumaße						Schaftform HA	
d ₁ h7	d ₂ h6	l ₁	l ₂	l ₃	l ₄	Spezifikation	Bestell-Nr.
11,00	12	204	156	142	45	SCD661-1100-3-3-140HA12-HP358	30902455
11,50	12	204	156	142	45	SCD661-1150-3-3-140HA12-HP358	30902460
11,80	12	204	156	142	45	SCD661-1180-3-3-140HA12-HP358	30902463
12,00	12	204	156	142	45	SCD661-1200-3-3-140HA12-HP358	30902465
12,50	14	230	182	166	45	SCD661-1250-3-3-140HA12-HP358	30902467
13,00	14	230	182	166	45	SCD661-1300-3-3-140HA12-HP358	30902469
13,50	14	230	182	166	45	SCD661-1350-3-3-140HA12-HP358	30902471
14,00	14	230	182	166	45	SCD661-1400-3-3-140HA12-HP358	30902473
14,50	16	260	208	192	48	SCD661-1450-3-3-140HA12-HP358	30902475
15,00	16	260	208	192	48	SCD661-1500-3-3-140HA12-HP358	30902477
15,50	16	260	208	192	48	SCD661-1550-3-3-140HA12-HP358	30902479
16,00	16	260	208	192	48	SCD661-1600-3-3-140HA12-HP358	30902481
16,50	18	285	234	216	48	SCD661-1650-3-3-140HA12-HP358	30902483
17,00	18	285	234	216	48	SCD661-1700-3-3-140HA12-HP358	30902485
17,50	18	285	234	216	48	SCD661-1750-3-3-140HA12-HP358	30902487
18,00	18	285	234	216	48	SCD661-1800-3-3-140HA12-HP358	30902489
18,50	20	310	258	240	50	SCD661-1850-3-3-140HA12-HP358	30902491
19,00	20	310	258	240	50	SCD661-1900-3-3-140HA12-HP358	30902493
19,50	20	310	258	240	50	SCD661-1950-3-3-140HA12-HP358	30902495
20,00	20	310	258	240	50	SCD661-2000-3-3-140HA12-HP358	30902497

Konfigurierbare Merkmale



Durchmesser:
Durchmesser in Abstufungen
von 0,01 mm frei wählbar



Schaftform:
Schaftform: HB | HE

Spezifikation:

SCD661-[Durchmesser]-3-3-140[Schaftform]12-HP358

Abmessungen konfigurierbare Baureihe

d ₁ min.	d ₁ max.	d ₂ h6	l ₁	l ₂	l ₃	l ₄
4,00	4,70	6	102	64	58	36
4,71	6,00	6	116	78	70	36
6,01	8,00	8	146	108	94	36
8,01	10,00	10	162	120	110	40
10,01	12,00	12	204	156	142	45
12,01	14,00	14	230	182	166	45
14,01	16,00	16	260	208	192	48
16,01	18,00	18	285	234	216	48
18,01	20,00	20	310	258	240	50

Beispiel:

SCD661-0431-3-3-140HE12-HP358

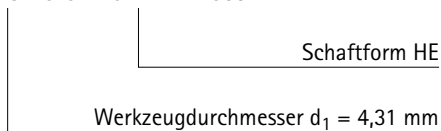

Maßangaben in mm.

Schnittwertempfehlung siehe Kapitelende.

Sonderausführungen und andere Beschichtungen auf Anfrage.

MEGA-Speed-Drill-Steel

Vollhartmetall-Spiralbohrer

SCD621 (3xD), innere Kühlmittelzufuhr, Nachfolgeprodukt des MEGA-Speed-Drill-Steel (SCD22)

Ausführung:

Bohrerdurchmesser:	3,00 – 20,00 mm
Bohrungstoleranz:	IT 9 (erreichbar)
Schneidstoff:	HP358
Schneidenanzahl:	2
Anzahl Führungsfasen:	3
Spitzenwinkel:	145°
Spiralwinkel:	30°

Anwendung:

Für Hochgeschwindigkeitsbearbeitung.

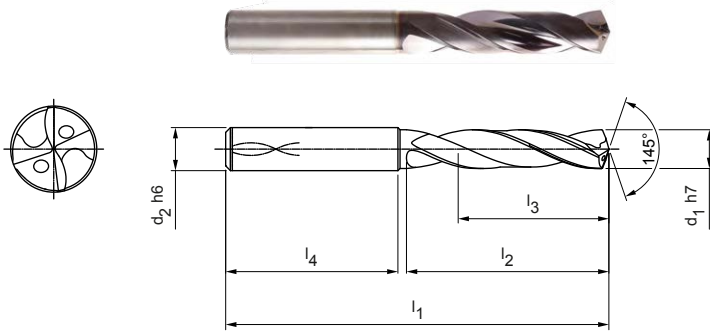

Lagerhaltige Vorzugsbaureihe in Schaftform HA

Baumaße						Schaftform HA	
d ₁ h7	d ₂ h6	l ₁	l ₂	l ₃	l ₄	Spezifikation	Bestell-Nr.
3,00	6	62	20	14	36	SCD621-0300-2-3-145HA03-HP358	31036265
3,20	6	62	20	14	36	SCD621-0320-2-3-145HA03-HP358	31036267
3,30	6	62	20	14	36	SCD621-0330-2-3-145HA03-HP358	31036268
3,40	6	62	20	14	36	SCD621-0340-2-3-145HA03-HP358	31036269
3,50	6	62	20	14	36	SCD621-0350-2-3-145HA03-HP358	31036270
3,70	6	62	20	14	36	SCD621-0370-2-3-145HA03-HP358	31036272
3,80	6	66	24	17	36	SCD621-0380-2-3-145HA03-HP358	31036273
3,90	6	66	24	17	36	SCD621-0390-2-3-145HA03-HP358	31036274
4,00	6	66	24	17	36	SCD621-0400-2-3-145HA03-HP358	31036275
4,10	6	66	24	17	36	SCD621-0410-2-3-145HA03-HP358	31036276
4,20	6	66	24	17	36	SCD621-0420-2-3-145HA03-HP358	31036277
4,30	6	66	24	17	36	SCD621-0430-2-3-145HA03-HP358	31036278
4,50	6	66	24	17	36	SCD621-0450-2-3-145HA03-HP358	31036280
4,60	6	66	24	17	36	SCD621-0460-2-3-145HA03-HP358	31036281
4,65	6	66	24	17	36	SCD621-0465-2-3-145HA03-HP358	31307528
4,70	6	66	24	17	36	SCD621-0470-2-3-145HA03-HP358	31036282
4,90	6	66	28	20	36	SCD621-0490-2-3-145HA03-HP358	31036284
5,00	6	66	28	20	36	SCD621-0500-2-3-145HA03-HP358	31036285
5,10	6	66	28	20	36	SCD621-0510-2-3-145HA03-HP358	31036286
5,20	6	66	28	20	36	SCD621-0520-2-3-145HA03-HP358	31036287
5,50	6	66	28	20	36	SCD621-0550-2-3-145HA03-HP358	31036290
5,60	6	66	28	20	36	SCD621-0560-2-3-145HA03-HP358	31036291
5,80	6	66	28	20	36	SCD621-0580-2-3-145HA03-HP358	31036293
5,90	6	66	28	20	36	SCD621-0590-2-3-145HA03-HP358	31036294
6,00	6	66	28	20	36	SCD621-0600-2-3-145HA03-HP358	31036295
6,10	8	79	34	24	36	SCD621-0610-2-3-145HA03-HP358	31036296
6,20	8	79	34	24	36	SCD621-0620-2-3-145HA03-HP358	31036297
6,30	8	79	34	24	36	SCD621-0630-2-3-145HA03-HP358	31036298
6,40	8	79	34	24	36	SCD621-0640-2-3-145HA03-HP358	31036299
6,50	8	79	34	24	36	SCD621-0650-2-3-145HA03-HP358	31036300
6,60	8	79	34	24	36	SCD621-0660-2-3-145HA03-HP358	31036301
6,80	8	79	34	24	36	SCD621-0680-2-3-145HA03-HP358	31036303
6,90	8	79	34	24	36	SCD621-0690-2-3-145HA03-HP358	31036304
7,00	8	79	34	24	36	SCD621-0700-2-3-145HA03-HP358	31036305
7,15	8	79	41	29	36	SCD621-0715-2-3-145HA03-HP358	31307529

Fortsetzung auf nächster Seite.

MEGA-Speed-Drill-Steel | Vollhartmetall-Spiralbohrer SCD621 (3xD), innere Kühlmittelzufuhr

Baumaße						Schaftform HA	
d ₁ h7	d ₂ h6	l ₁	l ₂	l ₃	l ₄	Spezifikation	Bestell-Nr.
7,30	8	79	41	29	36	SCD621-0730-2-3-145HA03-HP358	31036308
7,40	8	79	41	29	36	SCD621-0740-2-3-145HA03-HP358	31036309
7,50	8	79	41	29	36	SCD621-0750-2-3-145HA03-HP358	31036310
7,60	8	79	41	29	36	SCD621-0760-2-3-145HA03-HP358	31036311
7,70	8	79	41	29	36	SCD621-0770-2-3-145HA03-HP358	31036312
7,80	8	79	41	29	36	SCD621-0780-2-3-145HA03-HP358	31036313
8,00	8	79	41	29	36	SCD621-0800-2-3-145HA03-HP358	31036315
8,20	10	89	47	35	40	SCD621-0820-2-3-145HA03-HP358	31036317
8,50	10	89	47	35	40	SCD621-0850-2-3-145HA03-HP358	31036320
8,60	10	89	47	35	40	SCD621-0860-2-3-145HA03-HP358	31036321
8,70	10	89	47	35	40	SCD621-0870-2-3-145HA03-HP358	31036322
8,80	10	89	47	35	40	SCD621-0880-2-3-145HA03-HP358	31036323
8,90	10	89	47	35	40	SCD621-0890-2-3-145HA03-HP358	31036324
9,00	10	89	47	35	40	SCD621-0900-2-3-145HA03-HP358	31036325
9,10	10	89	47	35	40	SCD621-0910-2-3-145HA03-HP358	31036326
9,20	10	89	47	35	40	SCD621-0920-2-3-145HA03-HP358	31036327
9,30	10	89	47	35	40	SCD621-0930-2-3-145HA03-HP358	31036328
9,40	10	89	47	35	40	SCD621-0940-2-3-145HA03-HP358	31036329
9,50	10	89	47	35	40	SCD621-0950-2-3-145HA03-HP358	31036330
9,60	10	89	47	35	40	SCD621-0960-2-3-145HA03-HP358	31036331
9,80	10	89	47	35	40	SCD621-0980-2-3-145HA03-HP358	31036333
9,90	10	89	47	35	40	SCD621-0990-2-3-145HA03-HP358	31036334
10,00	10	89	47	35	40	SCD621-1000-2-3-145HA03-HP358	31036335
10,20	12	102	55	40	45	SCD621-1020-2-3-145HA03-HP358	31036337
10,30	12	102	55	40	45	SCD621-1030-2-3-145HA03-HP358	31036338
10,50	12	102	55	40	45	SCD621-1050-2-3-145HA03-HP358	31036340
11,00	12	102	55	40	45	SCD621-1100-2-3-145HA03-HP358	31036345
11,20	12	102	55	40	45	SCD621-1120-2-3-145HA03-HP358	31036347
11,50	12	102	55	40	45	SCD621-1150-2-3-145HA03-HP358	31036350
11,80	12	102	55	40	45	SCD621-1180-2-3-145HA03-HP358	31036353
11,90	12	102	55	40	45	SCD621-1190-2-3-145HA03-HP358	31036354
12,00	12	102	55	40	45	SCD621-1200-2-3-145HA03-HP358	31036355
13,00	14	107	60	43	45	SCD621-1300-2-3-145HA03-HP358	31036359
13,80	14	107	60	43	45	SCD621-1380-2-3-145HA03-HP358	31036361
14,00	14	107	60	43	45	SCD621-1400-2-3-145HA03-HP358	31036362
14,50	16	115	65	45	48	SCD621-1450-2-3-145HA03-HP358	31036364
15,00	16	115	65	45	48	SCD621-1500-2-3-145HA03-HP358	31036366
16,00	16	115	65	45	48	SCD621-1600-2-3-145HA03-HP358	31036370
17,00	18	123	73	51	48	SCD621-1700-2-3-145HA03-HP358	31036373
17,50	18	123	73	51	48	SCD621-1750-2-3-145HA03-HP358	31036374
18,00	18	123	73	51	48	SCD621-1800-2-3-145HA03-HP358	31036376
18,50	20	131	79	55	50	SCD621-1850-2-3-145HA03-HP358	31036377
20,00	20	131	79	55	50	SCD621-2000-2-3-145HA03-HP358	31036392

MEGA-Speed-Drill-Steel | Vollhartmetall-Spiralbohrer SCD621 (3xD), innere Kühlmittelzufuhr

Konfigurierbare Merkmale



Durchmesser:
Durchmesser in Abstufungen
von 0,01 mm frei wählbar



Schaftform:
Schaftform HB | HE

Spezifikation:

SCD621-[Durchmesser]-3-3-140[Schaftform]03-HP358

Beispiel:

SCD621-0431-2-3-140HE03-HP358

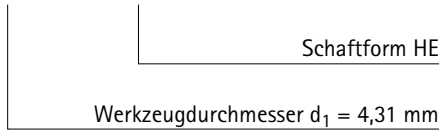

Abmessungen konfigurierbare Baureihe

d ₁ min.	d ₁ max.	d ₂ h6	l ₁	l ₂	l ₃	l ₄
3,00	3,70	6	62	20	14	36
3,71	4,70	6	66	24	17	36
4,71	6,00	6	66	28	20	36
6,01	6,80	8	79	34	24	36
6,81	8,00	8	79	41	29	36
8,01	10,00	10	89	47	35	40
10,01	12,00	12	102	55	40	45
12,01	14,00	14	107	60	43	45
14,01	16,00	16	115	65	45	48
16,01	18,00	18	123	73	51	48
18,01	20,00	20	131	79	55	50

Maßangaben in mm.

Schnittwertempfehlung siehe Kapitelende.

Sonderausführungen und andere Beschichtungen auf Anfrage.

MEGA-Speed-Drill-Steel

Vollhartmetall-Spiralbohrer

SCD621 (5xD), innere Kühlmittelzufuhr, Nachfolgeprodukt des MEGA-Speed-Drill-Steel (SCD22)

Ausführung:

- Bohrerdurchmesser: 3,00 – 20,00 mm
- Bohrungstoleranz: ≥ IT 9
- Schneidstoff: HP358
- Schneidenanzahl: 2
- Anzahl Führungsfasen: 3
- Spitzenwinkel: 145°
- Spiralwinkel: 30°

Anwendung:

Für Hochgeschwindigkeitsbearbeitung.

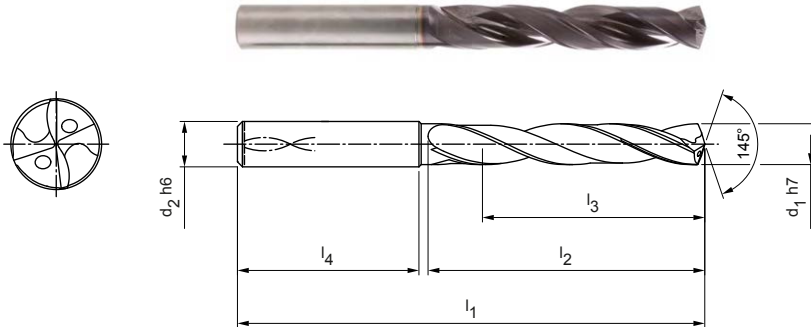

Lagerhaltige Vorzugsbaureihe in Schaftform HA

Baumaße						Schaftform HA	
d ₁ h7	d ₂ h6	l ₁	l ₂	l ₃	l ₄	Spezifikation	Bestell-Nr.
3,00	6	66	28	23	36	SCD621-0300-2-3-145HA05-HP358	30966287
3,10	6	66	28	23	36	SCD621-0310-2-3-145HA05-HP358	30966288
3,20	6	66	28	23	36	SCD621-0320-2-3-145HA05-HP358	30966289
3,30	6	66	28	23	36	SCD621-0330-2-3-145HA05-HP358	30966310
3,40	6	66	28	23	36	SCD621-0340-2-3-145HA05-HP358	30966311
3,50	6	66	28	23	36	SCD621-0350-2-3-145HA05-HP358	30959126
3,70	6	66	28	23	36	SCD621-0370-2-3-145HA05-HP358	30966313
3,80	6	74	36	29	36	SCD621-0380-2-3-145HA05-HP358	30966314
4,00	6	74	36	29	36	SCD621-0400-2-3-145HA05-HP358	30966316
4,20	6	74	36	29	36	SCD621-0420-2-3-145HA05-HP358	30966318
4,30	6	74	36	29	36	SCD621-0430-2-3-145HA05-HP358	30966319
4,50	6	74	36	29	36	SCD621-0450-2-3-145HA05-HP358	30966321
4,65	6	74	36	29	36	SCD621-0465-2-3-145HA05-HP358	31307540
4,70	6	74	36	29	36	SCD621-0470-2-3-145HA05-HP358	30966323
4,80	6	82	44	35	36	SCD621-0480-2-3-145HA05-HP358	30966324
4,90	6	82	44	35	36	SCD621-0490-2-3-145HA05-HP358	30966326
5,00	6	82	44	35	36	SCD621-0500-2-3-145HA05-HP358	30966327
5,10	6	82	44	35	36	SCD621-0510-2-3-145HA05-HP358	30966328
5,20	6	82	44	35	36	SCD621-0520-2-3-145HA05-HP358	30966329
5,30	6	82	44	35	36	SCD621-0530-2-3-145HA05-HP358	30966330
5,40	6	82	44	35	36	SCD621-0540-2-3-145HA05-HP358	30966331
5,50	6	82	44	35	36	SCD621-0550-2-3-145HA05-HP358	30966332
5,55	6	82	44	35	36	SCD621-0555-2-3-145HA05-HP358	31307541
5,60	6	82	44	35	36	SCD621-0560-2-3-145HA05-HP358	30966333
5,70	6	82	44	35	36	SCD621-0570-2-3-145HA05-HP358	30966334
5,80	6	82	44	35	36	SCD621-0580-2-3-145HA05-HP358	30966335
5,90	6	82	44	35	36	SCD621-0590-2-3-145HA05-HP358	30966336
6,00	6	82	44	35	36	SCD621-0600-2-3-145HA05-HP358	30966337
6,10	8	91	53	43	36	SCD621-0610-2-3-145HA05-HP358	30966338
6,20	8	91	53	43	36	SCD621-0620-2-3-145HA05-HP358	30966339
6,30	8	91	53	43	36	SCD621-0630-2-3-145HA05-HP358	30966340
6,50	8	91	53	43	36	SCD621-0650-2-3-145HA05-HP358	30966342
6,70	8	91	53	43	36	SCD621-0670-2-3-145HA05-HP358	30966344
6,80	8	91	53	43	36	SCD621-0680-2-3-145HA05-HP358	30966345

MEGA-Speed-Drill-Steel | Vollhartmetall-Spiralbohrer SCD621 (5xD), innere Kühlmittelzufuhr

Baumaße						Schaftform HA	
d ₁ h7	d ₂ h6	l ₁	l ₂	l ₃	l ₄	Spezifikation	Bestell-Nr.
6,90	8	91	53	43	36	SCD621-0690-2-3-145HA05-HP358	30966346
7,00	8	91	53	43	36	SCD621-0700-2-3-145HA05-HP358	30966347
7,10	8	91	53	43	36	SCD621-0710-2-3-145HA05-HP358	30966348
7,20	8	91	53	43	36	SCD621-0720-2-3-145HA05-HP358	30966349
7,30	8	91	53	43	36	SCD621-0730-2-3-145HA05-HP358	30966350
7,40	8	91	53	43	36	SCD621-0740-2-3-145HA05-HP358	30966351
7,50	8	91	53	43	36	SCD621-0750-2-3-145HA05-HP358	30966352
7,60	8	91	53	43	36	SCD621-0760-2-3-145HA05-HP358	30966353
7,80	8	91	53	43	36	SCD621-0780-2-3-145HA05-HP358	30966355
8,00	8	91	53	43	36	SCD621-0800-2-3-145HA05-HP358	30948674
8,10	10	103	61	49	40	SCD621-0810-2-3-145HA05-HP358	30966357
8,20	10	103	61	49	40	SCD621-0820-2-3-145HA05-HP358	30966358
8,30	10	103	61	49	40	SCD621-0830-2-3-145HA05-HP358	30966359
8,40	10	103	61	49	40	SCD621-0840-2-3-145HA05-HP358	30966360
8,50	10	103	61	49	40	SCD621-0850-2-3-145HA05-HP358	30959302
8,60	10	103	61	49	40	SCD621-0860-2-3-145HA05-HP358	30966361
8,70	10	89	47	35	40	SCD621-0870-2-3-145HA05-HP358	30812607
8,80	10	103	61	49	40	SCD621-0880-2-3-145HA05-HP358	30966362
9,00	10	103	61	49	40	SCD621-0900-2-3-145HA05-HP358	30966364
9,10	10	103	61	49	40	SCD621-0910-2-3-145HA05-HP358	30966365
9,30	10	103	61	49	40	SCD621-0930-2-3-145HA05-HP358	30966367
9,40	10	103	61	49	40	SCD621-0940-2-3-145HA05-HP358	30966368
9,50	10	103	61	49	40	SCD621-0950-2-3-145HA05-HP358	30966369
9,70	10	103	61	49	40	SCD621-0970-2-3-145HA05-HP358	30958145
9,80	10	103	61	49	40	SCD621-0980-2-3-145HA05-HP358	30959402
9,90	10	103	61	49	40	SCD621-0990-2-3-145HA05-HP358	30966371
10,00	10	103	61	49	40	SCD621-1000-2-3-145HA05-HP358	30948675
10,20	12	118	71	56	45	SCD621-1020-2-3-145HA05-HP358	30966373
10,30	12	118	71	56	45	SCD621-1030-2-3-145HA05-HP358	30966374
10,50	12	118	71	56	45	SCD621-1050-2-3-145HA05-HP358	30966376
11,00	12	118	71	56	45	SCD621-1100-2-3-145HA05-HP358	30966381
11,10	12	118	71	56	45	SCD621-1110-2-3-145HA05-HP358	30966382
11,20	12	118	71	56	45	SCD621-1120-2-3-145HA05-HP358	30966383
11,30	12	118	71	56	45	SCD621-1130-2-3-145HA05-HP358	30966384
11,40	12	118	71	56	45	SCD621-1140-2-3-145HA05-HP358	30966385
11,50	12	118	71	56	45	SCD621-1150-2-3-145HA05-HP358	30966386
11,60	12	118	71	56	45	SCD621-1160-2-3-145HA05-HP358	30966387
11,80	12	118	71	56	45	SCD621-1180-2-3-145HA05-HP358	30966389
11,90	12	118	71	56	45	SCD621-1190-2-3-145HA05-HP358	30966390
12,00	12	118	71	56	45	SCD621-1200-2-3-145HA05-HP358	30948676
12,20	14	124	77	60	45	SCD621-1220-2-3-145HA05-HP358	30966391
12,50	14	124	77	60	45	SCD621-1250-2-3-145HA05-HP358	30966392
12,80	14	124	77	60	45	SCD621-1280-2-3-145HA05-HP358	30980599
13,00	14	124	77	60	45	SCD621-1300-2-3-145HA05-HP358	30966393
13,50	14	124	77	60	45	SCD621-1350-2-3-145HA05-HP358	30966394
13,80	14	124	77	60	45	SCD621-1380-2-3-145HA05-HP358	30966395
14,00	14	124	77	60	45	SCD621-1400-2-3-145HA05-HP358	30966396
14,20	16	133	83	63	48	SCD621-1420-2-3-145HA05-HP358	30966397
14,50	16	133	83	63	48	SCD621-1450-2-3-145HA05-HP358	30966398
15,00	16	133	83	63	48	SCD621-1500-2-3-145HA05-HP358	30966400
15,20	16	133	83	63	48	SCD621-1520-2-3-145HA05-HP358	30966401
15,50	16	133	83	63	48	SCD621-1550-2-3-145HA05-HP358	30966402
16,00	16	133	83	63	48	SCD621-1600-2-3-145HA05-HP358	30966404
16,50	18	143	93	71	48	SCD621-1650-2-3-145HA05-HP358	30966405
17,00	18	143	93	71	48	SCD621-1700-2-3-145HA05-HP358	30966407
17,50	18	143	93	71	48	SCD621-1750-2-3-145HA05-HP358	30966408

Fortsetzung auf nächster Seite.

MEGA-Speed-Drill-Steel | Vollhartmetall-Spiralbohrer SCD621 (5xD), innere Kühlmittelzufuhr

Baumaße						Schaftform HA	
d ₁ h7	d ₂ h6	l ₁	l ₂	l ₃	l ₄	Spezifikation	Bestell-Nr.
18,00	18	143	93	71	48	SCD621-1800-2-3-145HA05-HP358	30966410
18,50	20	153	101	77	50	SCD621-1850-2-3-145HA05-HP358	30966411
19,80	20	153	101	77	50	SCD621-1980-2-3-145HA05-HP358	30966415
20,00	20	153	101	77	50	SCD621-2000-2-3-145HA05-HP358	30966416

Konfigurierbare Merkmale



Durchmesser:
Durchmesser in Abstufungen
von 0,01 mm frei wählbar



Schaftform:
Schaftform: HB | HE

Spezifikation:

SCD621-[Durchmesser]-2-3-145[Schaftform]05-HP358

Beispiel:

SCD621-0431-2-3-145HE05-HP358

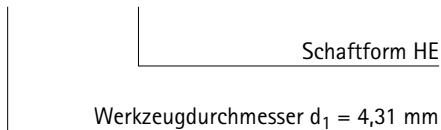

Abmessungen konfigurierbare Baureihe

d ₁ min.	d ₁ max.	d ₂ h6	l ₁	l ₂	l ₃	l ₄
3,00	3,70	6	66	28	23	36
3,71	4,70	6	74	36	29	36
4,71	6,00	6	82	44	35	36
6,01	6,80	8	91	53	43	36
6,81	8,00	8	91	53	43	36
8,01	9,00	10	103	61	49	40
9,01	10,00	10	103	61	49	40
10,01	11,00	12	118	71	56	45
11,01	12,00	12	118	71	56	45
12,01	14,00	14	124	77	60	45
14,01	16,00	16	133	83	63	48
16,01	18,00	18	143	93	71	48
18,01	20,00	20	153	101	77	50

Maßangaben in mm.

Schnittwertempfehlung siehe Kapitelende.

Sonderausführungen und andere Beschichtungen auf Anfrage.

MEGA-Speed-Drill-Steel

Vollhartmetall-Spiralbohrer

SCD621 (8xD), innere Kühlmittelzufuhr, Nachfolgeprodukt des MEGA-Speed-Drill-Steel (SCD22)

Ausführung:

Bohrerdurchmesser: 3,00 – 20,00 mm
 Bohrungstoleranz: IT 9 (erreichbar)
 Schneidstoff: HP358
 Schneidenanzahl: 2
 Anzahl Führungsfasen: 3
 Spitzenwinkel: 145°
 Spiralwinkel: 30°

Anwendung:

Für Hochgeschwindigkeitsbearbeitung.

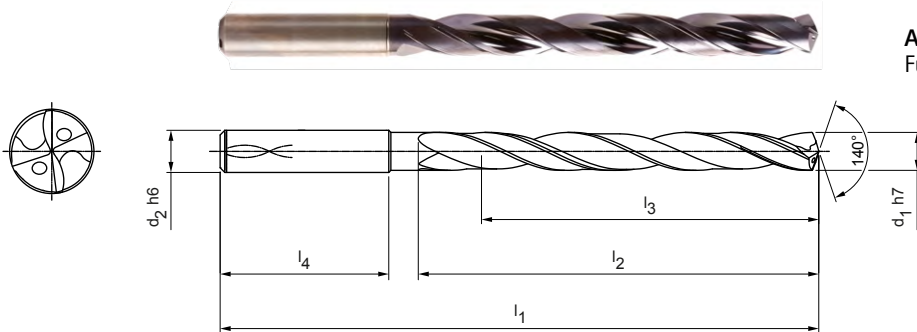

Lagerhaltige Vorzugsbaureihe in Schaftform HA

Baumaße						Schaftform HA	
d ₁ h7	d ₂ h6	l ₁	l ₂	l ₃	l ₄	Spezifikation	Bestell-Nr.
3,00	6	72	34	29	36	SCD621-0300-2-3-145HA08-HP358	31036147
3,10	6	72	34	29	36	SCD621-0310-2-3-145HA08-HP358	31036148
3,20	6	72	34	29	36	SCD621-0320-2-3-145HA08-HP358	31036149
3,30	6	72	34	29	36	SCD621-0330-2-3-145HA08-HP358	31036150
3,40	6	72	34	29	36	SCD621-0340-2-3-145HA08-HP358	31036151
3,50	6	72	34	29	36	SCD621-0350-2-3-145HA08-HP358	31036152
3,70	6	72	34	29	36	SCD621-0370-2-3-145HA08-HP358	31036154
4,00	6	81	43	36	36	SCD621-0400-2-3-145HA08-HP358	31036157
4,10	6	81	43	36	36	SCD621-0410-2-3-145HA08-HP358	31036158
4,20	6	81	43	36	36	SCD621-0420-2-3-145HA08-HP358	31036159
4,30	6	81	43	36	36	SCD621-0430-2-3-145HA08-HP358	31036160
4,50	6	81	43	36	36	SCD621-0450-2-3-145HA08-HP358	31036162
4,65	6	81	43	36	36	SCD621-0465-2-3-145HA08-HP358	31307542
4,80	6	95	57	48	36	SCD621-0480-2-3-145HA08-HP358	31036165
4,90	6	95	57	48	36	SCD621-0490-2-3-145HA08-HP358	31036166
5,00	6	95	57	48	36	SCD621-0500-2-3-145HA08-HP358	31036167
5,10	6	95	57	48	36	SCD621-0510-2-3-145HA08-HP358	31036168
5,20	6	95	57	48	36	SCD621-0520-2-3-145HA08-HP358	31036169
5,40	6	95	57	48	36	SCD621-0540-2-3-145HA08-HP358	31036171
5,50	6	95	57	48	36	SCD621-0550-2-3-145HA08-HP358	31036172
5,55	6	95	57	48	36	SCD621-0555-2-3-145HA08-HP358	31307543
5,60	6	95	57	48	36	SCD621-0560-2-3-145HA08-HP358	31036173
5,80	6	95	57	48	36	SCD621-0580-2-3-145HA08-HP358	31036175
5,90	6	95	57	48	36	SCD621-0590-2-3-145HA08-HP358	31036176
6,00	6	95	57	48	36	SCD621-0600-2-3-145HA08-HP358	31036177
6,10	8	114	76	64	36	SCD621-0610-2-3-145HA08-HP358	31036178
6,20	8	114	76	64	36	SCD621-0620-2-3-145HA08-HP358	31036179
6,50	8	114	76	64	36	SCD621-0650-2-3-145HA08-HP358	31036182
6,80	8	114	76	64	36	SCD621-0680-2-3-145HA08-HP358	31036185
6,90	8	114	76	64	36	SCD621-0690-2-3-145HA08-HP358	31036186
7,00	8	114	76	64	36	SCD621-0700-2-3-145HA08-HP358	31036187
7,50	8	114	76	64	36	SCD621-0750-2-3-145HA08-HP358	31036192
7,80	8	114	76	64	36	SCD621-0780-2-3-145HA08-HP358	31036195
8,00	8	114	76	64	36	SCD621-0800-2-3-145HA08-HP358	31036197
8,10	10	142	95	80	40	SCD621-0810-2-3-145HA08-HP358	31036198

Fortsetzung auf nächster Seite.

MEGA-Speed-Drill-Steel | Vollhartmetall-Spiralbohrer SCD621 (8xD), innere Kühlmittelzufuhr

Baumaße						Schaftform HA	
d ₁ h7	d ₂ h6	l ₁	l ₂	l ₃	l ₄	Spezifikation	Bestell-Nr.
8,50	10	142	95	80	40	SCD621-0850-2-3-145HA08-HP358	31036202
9,00	10	142	95	80	40	SCD621-0900-2-3-145HA08-HP358	31036207
9,50	10	142	95	80	40	SCD621-0950-2-3-145HA08-HP358	31036212
9,80	10	142	95	80	40	SCD621-0980-2-3-145HA08-HP358	31036215
10,00	10	142	95	80	40	SCD621-1000-2-3-145HA08-HP358	31036217
10,20	12	162	114	96	45	SCD621-1020-2-3-145HA08-HP358	31036219
10,30	12	162	114	96	45	SCD621-1030-2-3-145HA08-HP358	31036220
10,50	12	162	114	96	45	SCD621-1050-2-3-145HA08-HP358	31036222
11,00	12	162	114	96	45	SCD621-1100-2-3-145HA08-HP358	31036227
11,80	12	162	114	96	45	SCD621-1180-2-3-145HA08-HP358	31036235
12,00	12	162	114	96	45	SCD621-1200-2-3-145HA08-HP358	31036237
12,50	14	178	133	112	45	SCD621-1250-2-3-145HA08-HP358	31036239
13,00	14	178	133	112	45	SCD621-1300-2-3-145HA08-HP358	31036241
13,50	14	178	133	112	45	SCD621-1350-2-3-145HA08-HP358	31036242
14,00	14	178	133	112	45	SCD621-1400-2-3-145HA08-HP358	31036244
15,00	16	203	152	128	48	SCD621-1500-2-3-145HA08-HP358	31036248
15,80	16	203	152	128	48	SCD621-1580-2-3-145HA08-HP358	31036251
16,00	16	203	152	128	48	SCD621-1600-2-3-145HA08-HP358	31036252
19,00	20	243	190	160	50	SCD621-1900-2-3-145HA08-HP358	31036261
19,80	20	243	190	160	50	SCD621-1980-2-3-145HA08-HP358	31036263

Konfigurierbare Merkmale



Durchmesser:
Durchmesser in Abstufungen
von 0,01 mm frei wählbar



Schaftform:
Schaftform: HB | HE

Spezifikation:

SCD621-[Durchmesser]-2-3-145[Schaftform]08-HP358

Beispiel:

SCD621-0431-2-3-145HE08-HP358

Schaftform HE

Werkzeugdurchmesser d₁ = 4,31 mm

Abmessungen konfigurierbare Baureihe

d ₁ min.	d ₁ max.	d ₂ h6	l ₁	l ₂	l ₃	l ₄
3,00	3,70	6	72	34	29	36
3,71	4,70	6	81	43	36	36
4,71	6,00	6	95	57	48	36
6,01	6,80	8	114	76	64	36
6,81	8,00	8	114	76	64	36
8,01	9,00	10	142	95	80	40
9,01	10,00	10	142	95	80	40
10,01	11,00	12	162	114	96	45
11,01	12,00	12	162	114	96	45
12,01	14,00	14	178	133	112	45
14,01	16,00	16	203	152	128	48
16,01	18,00	18	222	171	144	48
18,01	20,00	20	243	190	160	50

Maßangaben in mm.

Schnittwertempfehlung siehe Kapitelende.

Sonderausführungen und andere Beschichtungen auf Anfrage.

MEGA-Speed-Drill-Steel

Vollhartmetall-Spiralbohrer

SCD621 (12xD), innere Kühlmittelzufuhr, Nachfolgeprodukt des MEGA-Speed-Drill-Steel (SCD22)

Ausführung:

Bohrerdurchmesser:	3,00 – 20,00 mm
Bohrungstoleranz:	≥ IT 9
Schneidstoff:	HP358
Schneidenanzahl:	2
Anzahl Führungsfasen:	3
Spitzenwinkel:	145°
Spiralwinkel:	30°

Anwendung:

Für Hochgeschwindigkeitsbearbeitung.

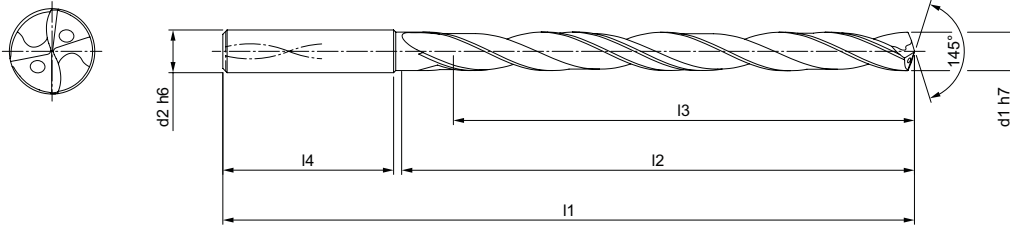

Lagerhaltige Vorzugsbaureihe in Schaftform HA

Baumaße						Schaftform HA	
d ₁ h7	d ₂ h6	l ₁	l ₂	l ₃	l ₄	Spezifikation	Bestell-Nr.
3,00	6	92	54	48	36	SCD621-0300-2-3-145HA12-HP358	31239148
3,20	6	92	54	48	36	SCD621-0320-2-3-145HA12-HP358	31239150
3,30	6	92	54	48	36	SCD621-0330-2-3-145HA12-HP358	31239151
3,40	6	92	54	48	36	SCD621-0340-2-3-145HA12-HP358	31239152
3,50	6	92	54	48	36	SCD621-0350-2-3-145HA12-HP358	31239153
3,70	6	92	54	48	36	SCD621-0370-2-3-145HA12-HP358	31239155
4,00	6	102	64	58	36	SCD621-0400-2-3-145HA12-HP358	31239158
4,10	6	102	64	58	36	SCD621-0410-2-3-145HA12-HP358	31239159
4,20	6	102	64	58	36	SCD621-0420-2-3-145HA12-HP358	31239160
4,30	6	102	64	58	36	SCD621-0430-2-3-145HA12-HP358	31239161
4,50	6	102	64	58	36	SCD621-0450-2-3-145HA12-HP358	31239163
4,80	6	116	78	70	36	SCD621-0480-2-3-145HA12-HP358	31239166
5,00	6	116	78	70	36	SCD621-0500-2-3-145HA12-HP358	31239168
5,10	6	116	78	70	36	SCD621-0510-2-3-145HA12-HP358	31239169
5,20	6	116	78	70	36	SCD621-0520-2-3-145HA12-HP358	31239170
5,40	6	116	78	70	36	SCD621-0540-2-3-145HA12-HP358	31239172
5,50	6	116	78	70	36	SCD621-0550-2-3-145HA12-HP358	31239173
5,80	6	116	78	70	36	SCD621-0580-2-3-145HA12-HP358	31239176
6,00	6	116	78	70	36	SCD621-0600-2-3-145HA12-HP358	31239178
6,10	8	146	108	94	36	SCD621-0610-2-3-145HA12-HP358	31239179
6,50	8	146	108	94	36	SCD621-0650-2-3-145HA12-HP358	31239183
6,80	8	146	108	94	36	SCD621-0680-2-3-145HA12-HP358	31239186
7,00	8	146	108	94	36	SCD621-0700-2-3-145HA12-HP358	31239188
7,50	8	146	108	94	36	SCD621-0750-2-3-145HA12-HP358	31239193
7,80	8	146	108	94	36	SCD621-0780-2-3-145HA12-HP358	31239196
8,00	8	146	108	94	36	SCD621-0800-2-3-145HA12-HP358	31239198
8,50	10	162	120	110	40	SCD621-0850-2-3-145HA12-HP358	31239203
9,00	10	162	120	110	40	SCD621-0900-2-3-145HA12-HP358	31239208
9,50	10	162	120	110	40	SCD621-0950-2-3-145HA12-HP358	31239213
9,80	10	162	120	110	40	SCD621-0980-2-3-145HA12-HP358	31239216
10,00	10	162	120	110	40	SCD621-1000-2-3-145HA12-HP358	31239218
10,20	12	204	156	142	45	SCD621-1020-2-3-145HA12-HP358	31239220
10,50	12	204	156	142	45	SCD621-1050-2-3-145HA12-HP358	31239223
11,00	12	204	156	142	45	SCD621-1100-2-3-145HA12-HP358	31239228
11,80	12	204	156	142	45	SCD621-1180-2-3-145HA12-HP358	31239236

Fortsetzung auf nächster Seite.

MEGA-Speed-Drill-Steel | Vollhartmetall-Spiralbohrer SCD621 (12xD), innere Kühlmittelzufuhr

Baumaße						Schaftform HA	
d ₁ h7	d ₂ h6	l ₁	l ₂	l ₃	l ₄	Spezifikation	Bestell-Nr.
12,00	12	204	156	142	45	SCD621-1200-2-3-145HA12-HP358	31239238
12,50	14	230	182	166	45	SCD621-1250-2-3-145HA12-HP358	31239240
13,00	14	230	182	166	45	SCD621-1300-2-3-145HA12-HP358	31239242
13,50	14	230	182	166	45	SCD621-1350-2-3-145HA12-HP358	31239243
14,00	14	230	182	166	45	SCD621-1400-2-3-145HA12-HP358	31239245
15,00	16	260	208	192	48	SCD621-1500-2-3-145HA12-HP358	31239248
16,00	16	260	208	192	48	SCD621-1600-2-3-145HA12-HP358	31239253

Konfigurierbare Merkmale



Durchmesser:
Durchmesser in Abstufungen
von 0,01 mm frei wählbar



Schaftform:
Schaftform: HB | HE

Spezifikation:

SCD621-[Durchmesser]-2-3-145[Schaftform]12-HP358

Beispiel:

SCD621-0431-2-3-145HE12-HP358

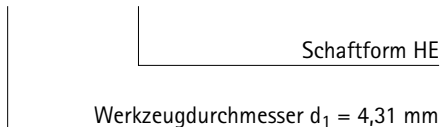

Abmessungen konfigurierbare Baureihe

d ₁ min.	d ₁ max.	d ₂ h6	l ₁	l ₂	l ₃	l ₄
3,00	3,70	6	92	54	48	36
3,71	4,70	6	102	64	58	36
4,71	6,00	6	116	78	70	36
6,01	6,80	8	146	108	94	36
6,81	8,00	8	146	108	94	36
8,01	9,00	10	162	120	110	40
9,01	10,00	10	162	120	110	40
10,01	11,00	12	204	156	142	45
11,01	12,00	12	204	156	142	45
12,01	14,00	14	230	182	166	45
14,01	16,00	16	260	208	192	48
16,01	18,00	18	285	234	216	48
18,01	20,00	20	310	258	240	50

MEGA-180°-Drill

Vollhartmetall-Spiralbohrer
SCD231 (3xD), innere Kühlmittelzufuhr

Ausführung:

Bohrerdurchmesser: 3,00 – 20,00 mm
Bohrungstoleranz: \geq IT 9
Schneidstoff: HP230
Schneidenanzahl: 2
Anzahl Führungsfasen: 4
Spitzenwinkel: 180°
Spiralwinkel: 30°

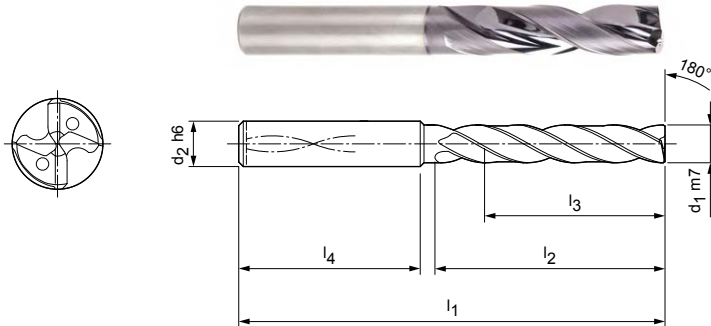

Lagerhaltige Vorzugsbaureihe in Schaftform HA

Baumaße						Schaftform HA	
d_1 m7	d_2 h6	l_1	l_2	l_3	l_4	Spezifikation	Bestell-Nr.
3,00	6	62	20	14	36	SCD231-0300-2-4-180HA03-HP230	30382647
3,10	6	62	20	14	36	SCD231-0310-2-4-180HA03-HP230	30382648
3,20	6	62	20	14	36	SCD231-0320-2-4-180HA03-HP230	30382649
3,30	6	62	20	14	36	SCD231-0330-2-4-180HA03-HP230	30382650
3,40	6	62	20	14	36	SCD231-0340-2-4-180HA03-HP230	30382651
3,50	6	62	20	14	36	SCD231-0350-2-4-180HA03-HP230	30382652
3,60	6	62	20	14	36	SCD231-0360-2-4-180HA03-HP230	30382653
3,70	6	62	20	14	36	SCD231-0370-2-4-180HA03-HP230	30382654
3,80	6	66	24	17	36	SCD231-0380-2-4-180HA03-HP230	30382655
3,90	6	66	24	17	36	SCD231-0390-2-4-180HA03-HP230	30382656
4,00	6	66	24	17	36	SCD231-0400-2-4-180HA03-HP230	30382657
4,10	6	66	24	17	36	SCD231-0410-2-4-180HA03-HP230	30382658
4,20	6	66	24	17	36	SCD231-0420-2-4-180HA03-HP230	30382659
4,30	6	66	24	17	36	SCD231-0430-2-4-180HA03-HP230	30382660
4,40	6	66	24	17	36	SCD231-0440-2-4-180HA03-HP230	30382661
4,50	6	66	24	17	36	SCD231-0450-2-4-180HA03-HP230	30382662
4,60	6	66	24	17	36	SCD231-0460-2-4-180HA03-HP230	30382663
4,65	6	66	24	17	36	SCD231-0465-2-4-180HA03-HP230	30382664
4,70	6	66	24	17	36	SCD231-0470-2-4-180HA03-HP230	30382665
4,80	6	66	28	20	36	SCD231-0480-2-4-180HA03-HP230	30382666
4,90	6	66	28	20	36	SCD231-0490-2-4-180HA03-HP230	30382667
5,00	6	66	28	20	36	SCD231-0500-2-4-180HA03-HP230	30382668
5,10	6	66	28	20	36	SCD231-0510-2-4-180HA03-HP230	30382669
5,20	6	66	28	20	36	SCD231-0520-2-4-180HA03-HP230	30382670
5,30	6	66	28	20	36	SCD231-0530-2-4-180HA03-HP230	30382671
5,40	6	66	28	20	36	SCD231-0540-2-4-180HA03-HP230	30382672
5,50	6	66	28	20	36	SCD231-0550-2-4-180HA03-HP230	30382673
5,55	6	66	28	20	36	SCD231-0555-2-4-180HA03-HP230	30382674
5,60	6	66	28	20	36	SCD231-0560-2-4-180HA03-HP230	30382675
5,70	6	66	28	20	36	SCD231-0570-2-4-180HA03-HP230	30382676
5,80	6	66	28	20	36	SCD231-0580-2-4-180HA03-HP230	30382677
5,90	6	66	28	20	36	SCD231-0590-2-4-180HA03-HP230	30382678
6,00	6	66	28	20	36	SCD231-0600-2-4-180HA03-HP230	30382679
6,10	8	79	34	24	36	SCD231-0610-2-4-180HA03-HP230	30382680
6,20	8	79	34	24	36	SCD231-0620-2-4-180HA03-HP230	30382681

Fortsetzung auf nächster Seite.

MEGA-180°-Drill | Vollhartmetall-Spiralbohrer SCD231 (3xD), innere Kühlmittelzufuhr

Baumaße						Schaftform HA	
d ₁ m7	d ₂ h6	l ₁	l ₂	l ₃	l ₄	Spezifikation	Bestell-Nr.
6,30	8	79	34	24	36	SCD231-0630-2-4-180HA03-HP230	30382682
6,40	8	79	34	24	36	SCD231-0640-2-4-180HA03-HP230	30382683
6,50	8	79	34	24	36	SCD231-0650-2-4-180HA03-HP230	30382684
6,60	8	79	34	24	36	SCD231-0660-2-4-180HA03-HP230	30382685
6,70	8	79	34	24	36	SCD231-0670-2-4-180HA03-HP230	30382686
6,80	8	79	34	24	36	SCD231-0680-2-4-180HA03-HP230	30382687
6,90	8	79	34	24	36	SCD231-0690-2-4-180HA03-HP230	30382688
7,00	8	79	34	24	36	SCD231-0700-2-4-180HA03-HP230	30382689
7,10	8	79	41	29	36	SCD231-0710-2-4-180HA03-HP230	30382690
7,20	8	79	41	29	36	SCD231-0720-2-4-180HA03-HP230	30382691
7,30	8	79	41	29	36	SCD231-0730-2-4-180HA03-HP230	30382692
7,40	8	79	41	29	36	SCD231-0740-2-4-180HA03-HP230	30382693
7,50	8	79	41	29	36	SCD231-0750-2-4-180HA03-HP230	30382694
7,60	8	79	41	29	36	SCD231-0760-2-4-180HA03-HP230	30382695
7,70	8	79	41	29	36	SCD231-0770-2-4-180HA03-HP230	30382696
7,80	8	79	41	29	36	SCD231-0780-2-4-180HA03-HP230	30382697
7,90	8	79	41	29	36	SCD231-0790-2-4-180HA03-HP230	30382698
8,00	8	79	41	29	36	SCD231-0800-2-4-180HA03-HP230	30382699
8,10	10	89	47	35	40	SCD231-0810-2-4-180HA03-HP230	30382700
8,20	10	89	47	35	40	SCD231-0820-2-4-180HA03-HP230	30382701
8,30	10	89	47	35	40	SCD231-0830-2-4-180HA03-HP230	30382702
8,40	10	89	47	35	40	SCD231-0840-2-4-180HA03-HP230	30382703
8,50	10	89	47	35	40	SCD231-0850-2-4-180HA03-HP230	30382704
8,60	10	89	47	35	40	SCD231-0860-2-4-180HA03-HP230	30382705
8,70	10	89	47	35	40	SCD231-0870-2-4-180HA03-HP230	30382706
8,80	10	89	47	35	40	SCD231-0880-2-4-180HA03-HP230	30382707
8,90	10	89	47	35	40	SCD231-0890-2-4-180HA03-HP230	30382708
9,00	10	89	47	35	40	SCD231-0900-2-4-180HA03-HP230	30382709
9,10	10	89	47	35	40	SCD231-0910-2-4-180HA03-HP230	30382710
9,20	10	89	47	35	40	SCD231-0920-2-4-180HA03-HP230	30382711
9,30	10	89	47	35	40	SCD231-0930-2-4-180HA03-HP230	30382712
9,40	10	89	47	35	40	SCD231-0940-2-4-180HA03-HP230	30382713
9,50	10	89	47	35	40	SCD231-0950-2-4-180HA03-HP230	30382714
9,60	10	89	47	35	40	SCD231-0960-2-4-180HA03-HP230	30382715
9,70	10	89	47	35	40	SCD231-0970-2-4-180HA03-HP230	30382716
9,80	10	89	47	35	40	SCD231-0980-2-4-180HA03-HP230	30382717
9,90	10	89	47	35	40	SCD231-0990-2-4-180HA03-HP230	30382718
10,00	10	89	47	35	40	SCD231-1000-2-4-180HA03-HP230	30382719
10,10	12	100	53	38	45	SCD231-1010-2-4-180HA03-HP230	30382720
10,20	12	100	53	38	45	SCD231-1020-2-4-180HA03-HP230	30382721
10,30	12	100	53	38	45	SCD231-1030-2-4-180HA03-HP230	30382722
10,40	12	100	53	38	45	SCD231-1040-2-4-180HA03-HP230	30382723
10,50	12	100	53	38	45	SCD231-1050-2-4-180HA03-HP230	30382724
10,60	12	100	53	38	45	SCD231-1060-2-4-180HA03-HP230	30382725
10,70	12	100	53	38	45	SCD231-1070-2-4-180HA03-HP230	30382726
10,80	12	100	53	38	45	SCD231-1080-2-4-180HA03-HP230	30382727
11,00	12	100	53	38	45	SCD231-1100-2-4-180HA03-HP230	30382729
11,10	12	100	53	38	45	SCD231-1110-2-4-180HA03-HP230	30382730
11,20	12	100	53	38	45	SCD231-1120-2-4-180HA03-HP230	30382731
11,30	12	100	53	38	45	SCD231-1130-2-4-180HA03-HP230	30382732
11,40	12	100	53	38	45	SCD231-1140-2-4-180HA03-HP230	30382733
11,50	12	100	53	38	45	SCD231-1150-2-4-180HA03-HP230	30382734
11,60	12	100	53	38	45	SCD231-1160-2-4-180HA03-HP230	30382735
11,70	12	100	53	38	45	SCD231-1170-2-4-180HA03-HP230	30382736
11,80	12	100	53	38	45	SCD231-1180-2-4-180HA03-HP230	30382737
11,90	12	100	53	38	45	SCD231-1190-2-4-180HA03-HP230	30382738
12,00	12	100	53	38	45	SCD231-1200-2-4-180HA03-HP230	30382739

MEGA-180°-Drill | Vollhartmetall-Spiralbohrer SCD231 (3xD), innere Kühlmittelzufuhr

Baumaße						Schaftform HA	
d ₁ m7	d ₂ h6	l ₁	l ₂	l ₃	l ₄	Spezifikation	Bestell-Nr.
12,50	14	105	58	41	45	SCD231-1250-2-4-180HA03-HP230	30382740
12,70	14	105	58	41	45	SCD231-1270-2-4-180HA03-HP230	30852019
12,80	14	105	58	41	45	SCD231-1280-2-4-180HA03-HP230	30382741
13,00	14	105	58	41	45	SCD231-1300-2-4-180HA03-HP230	30382742
13,50	14	105	58	41	45	SCD231-1350-2-4-180HA03-HP230	30382743
13,80	14	105	58	41	45	SCD231-1380-2-4-180HA03-HP230	30382744
14,00	14	105	58	41	45	SCD231-1400-2-4-180HA03-HP230	30382745
14,50	16	113	63	43	48	SCD231-1450-2-4-180HA03-HP230	30382746
14,80	16	113	63	43	48	SCD231-1480-2-4-180HA03-HP230	30382747
15,00	16	113	63	43	48	SCD231-1500-2-4-180HA03-HP230	30382748
15,50	16	113	63	43	48	SCD231-1550-2-4-180HA03-HP230	30382749
15,80	16	113	63	43	48	SCD231-1580-2-4-180HA03-HP230	30382750
16,00	16	113	63	43	48	SCD231-1600-2-4-180HA03-HP230	30382751
16,50	18	121	71	49	48	SCD231-1650-2-4-180HA03-HP230	30382752
16,80	18	121	71	49	48	SCD231-1680-2-4-180HA03-HP230	30382753
17,00	18	121	71	49	48	SCD231-1700-2-4-180HA03-HP230	30382754
17,50	18	121	71	49	48	SCD231-1750-2-4-180HA03-HP230	30382755
18,00	18	121	71	49	48	SCD231-1800-2-4-180HA03-HP230	30382757
18,50	20	129	77	53	50	SCD231-1850-2-4-180HA03-HP230	30382758
18,80	20	129	77	53	50	SCD231-1880-2-4-180HA03-HP230	30382759
19,00	20	129	77	53	50	SCD231-1900-2-4-180HA03-HP230	30382760
19,50	20	129	77	53	50	SCD231-1950-2-4-180HA03-HP230	30382761
20,00	20	129	77	53	50	SCD231-2000-2-4-180HA03-HP230	30382763

Konfigurierbare Merkmale



Durchmesser:
Durchmesser in Abstufungen
von 0,01 mm frei wählbar



Schaftform:
Schaftform: HB | HE

Spezifikation:

SCD231-[Durchmesser]-2-4-180[Schaftform]03-HP230

Abmessungen konfigurierbare Baureihe

d ₁ min.	d ₁ max.	d ₂ h6	l ₁	l ₂	l ₃	l ₄
3,00	3,70	6	62	20	14	36
3,71	4,70	6	66	24	17	36
4,71	6,00	6	66	28	20	36
6,01	6,80	8	79	34	24	36
6,81	8,00	8	79	41	29	36
8,01	10,00	10	89	47	35	40
10,01	12,00	12	100	53	38	45
12,01	14,00	14	105	58	41	45
14,01	16,00	16	113	63	43	48
16,01	18,00	18	121	71	49	48
18,01	20,00	20	129	77	53	50

Beispiel:

SCD231-0431-2-4-180HE03-HP230

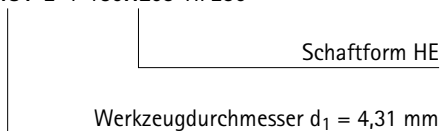

Maßangaben in mm.

Schnittwertempfehlung siehe Kapitelende.

Sonderausführungen und andere Beschichtungen auf Anfrage.

MEGA-180°-Drill

Vollhartmetall-Spiralbohrer
SCD231 (5xD), innere Kühlmittelzufuhr

Ausführung:

Bohrerdurchmesser: 3,00 – 20,00 mm
Bohrungstoleranz: \geq IT 9
Schneidstoff: HP230
Schneidenanzahl: 2
Anzahl Führungsfasen: 4
Spitzenwinkel: 180°
Spiralwinkel: 30°

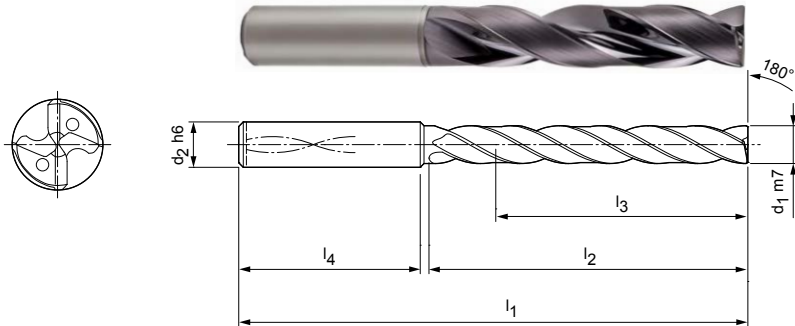

Lagerhaltige Vorzugsbaureihe in Schaftform HA

Baumaße						Schaftform HA	
d ₁ m7	d ₂ h6	l ₁	l ₂	l ₃	l ₄	Spezifikation	Bestell-Nr.
3,00	6	66	28	23	36	SCD231-0300-2-4-180HA05-HP230	30382764
3,10	6	66	28	23	36	SCD231-0310-2-4-180HA05-HP230	30382765
3,20	6	66	28	23	36	SCD231-0320-2-4-180HA05-HP230	30382766
3,30	6	66	28	23	36	SCD231-0330-2-4-180HA05-HP230	30382767
3,40	6	66	28	23	36	SCD231-0340-2-4-180HA05-HP230	30382768
3,50	6	66	28	23	36	SCD231-0350-2-4-180HA05-HP230	30382769
3,60	6	66	28	23	36	SCD231-0360-2-4-180HA05-HP230	30382770
3,70	6	66	28	23	36	SCD231-0370-2-4-180HA05-HP230	30382771
3,80	6	74	36	29	36	SCD231-0380-2-4-180HA05-HP230	30382772
3,90	6	74	36	29	36	SCD231-0390-2-4-180HA05-HP230	30382773
4,00	6	74	36	29	36	SCD231-0400-2-4-180HA05-HP230	30382774
4,10	6	74	36	29	36	SCD231-0410-2-4-180HA05-HP230	30382775
4,20	6	74	36	29	36	SCD231-0420-2-4-180HA05-HP230	30382776
4,30	6	74	36	29	36	SCD231-0430-2-4-180HA05-HP230	30382777
4,40	6	74	36	29	36	SCD231-0440-2-4-180HA05-HP230	30382778
4,50	6	74	36	29	36	SCD231-0450-2-4-180HA05-HP230	30382779
4,60	6	74	36	29	36	SCD231-0460-2-4-180HA05-HP230	30382780
4,80	6	82	44	35	36	SCD231-0480-2-4-180HA05-HP230	30382783
4,90	6	82	44	35	36	SCD231-0490-2-4-180HA05-HP230	30382784
5,00	6	82	44	35	36	SCD231-0500-2-4-180HA05-HP230	30382785
5,10	6	82	44	35	36	SCD231-0510-2-4-180HA05-HP230	30382786
5,20	6	82	44	35	36	SCD231-0520-2-4-180HA05-HP230	30382787
5,30	6	82	44	35	36	SCD231-0530-2-4-180HA05-HP230	30382788
5,40	6	82	44	35	36	SCD231-0540-2-4-180HA05-HP230	30382789
5,50	6	82	44	35	36	SCD231-0550-2-4-180HA05-HP230	30382790
5,55	6	82	44	35	36	SCD231-0555-2-4-180HA05-HP230	30382791
5,60	6	82	44	35	36	SCD231-0560-2-4-180HA05-HP230	30382792
5,70	6	82	44	35	36	SCD231-0570-2-4-180HA05-HP230	30382793
5,80	6	82	44	35	36	SCD231-0580-2-4-180HA05-HP230	30382794
5,90	6	82	44	35	36	SCD231-0590-2-4-180HA05-HP230	30382795
6,00	6	82	44	35	36	SCD231-0600-2-4-180HA05-HP230	30382796
6,10	8	91	53	43	36	SCD231-0610-2-4-180HA05-HP230	30382797
6,20	8	91	53	43	36	SCD231-0620-2-4-180HA05-HP230	30382798
6,30	8	91	53	43	36	SCD231-0630-2-4-180HA05-HP230	30382799
6,40	8	91	53	43	36	SCD231-0640-2-4-180HA05-HP230	30382800

MEGA-180°-Drill | Vollhartmetall-Spiralbohrer SCD231 (5xD), innere Kühlmittelzufuhr

Baumaße						Schaftform HA	
d ₁ m7	d ₂ h6	l ₁	l ₂	l ₃	l ₄	Spezifikation	Bestell-Nr.
6,50	8	91	53	43	36	SCD231-0650-2-4-180HA05-HP230	30382801
6,60	8	91	53	43	36	SCD231-0660-2-4-180HA05-HP230	30382802
6,70	8	91	53	43	36	SCD231-0670-2-4-180HA05-HP230	30382803
6,80	8	91	53	43	36	SCD231-0680-2-4-180HA05-HP230	30382804
6,90	8	91	53	43	36	SCD231-0690-2-4-180HA05-HP230	30382805
7,00	8	91	53	43	36	SCD231-0700-2-4-180HA05-HP230	30382806
7,10	8	91	53	43	36	SCD231-0710-2-4-180HA05-HP230	30382807
7,20	8	91	53	43	36	SCD231-0720-2-4-180HA05-HP230	30382808
7,30	8	91	53	43	36	SCD231-0730-2-4-180HA05-HP230	30382809
7,40	8	91	53	43	36	SCD231-0740-2-4-180HA05-HP230	30382810
7,50	8	91	53	43	36	SCD231-0750-2-4-180HA05-HP230	30382811
7,60	8	91	53	43	36	SCD231-0760-2-4-180HA05-HP230	30382812
7,80	8	91	53	43	36	SCD231-0780-2-4-180HA05-HP230	30382814
7,90	8	91	53	43	36	SCD231-0790-2-4-180HA05-HP230	30382815
8,00	8	91	53	43	36	SCD231-0800-2-4-180HA05-HP230	30382816
8,10	10	103	61	49	40	SCD231-0810-2-4-180HA05-HP230	30382817
8,20	10	103	61	49	40	SCD231-0820-2-4-180HA05-HP230	30382818
8,30	10	103	61	49	40	SCD231-0830-2-4-180HA05-HP230	30382819
8,40	10	103	61	49	40	SCD231-0840-2-4-180HA05-HP230	30382820
8,50	10	103	61	49	40	SCD231-0850-2-4-180HA05-HP230	30382821
8,60	10	103	61	49	40	SCD231-0860-2-4-180HA05-HP230	30382822
8,70	10	103	61	49	40	SCD231-0870-2-4-180HA05-HP230	30382823
8,80	10	103	61	49	40	SCD231-0880-2-4-180HA05-HP230	30382824
8,90	10	103	61	49	40	SCD231-0890-2-4-180HA05-HP230	30382825
9,00	10	103	61	49	40	SCD231-0900-2-4-180HA05-HP230	30382826
9,10	10	103	61	49	40	SCD231-0910-2-4-180HA05-HP230	30382827
9,20	10	103	61	49	40	SCD231-0920-2-4-180HA05-HP230	30382828
9,30	10	103	61	49	40	SCD231-0930-2-4-180HA05-HP230	30382829
9,40	10	103	61	49	40	SCD231-0940-2-4-180HA05-HP230	30382830
9,50	10	103	61	49	40	SCD231-0950-2-4-180HA05-HP230	30382831
9,60	10	103	61	49	40	SCD231-0960-2-4-180HA05-HP230	30382832
9,70	10	103	61	49	40	SCD231-0970-2-4-180HA05-HP230	30382833
9,80	10	103	61	49	40	SCD231-0980-2-4-180HA05-HP230	30382834
9,90	10	103	61	49	40	SCD231-0990-2-4-180HA05-HP230	30382835
10,00	10	103	61	49	40	SCD231-1000-2-4-180HA05-HP230	30382836
10,10	12	116	69	54	45	SCD231-1010-2-4-180HA05-HP230	30382838
10,20	12	116	69	54	45	SCD231-1020-2-4-180HA05-HP230	30382840
10,30	12	116	69	54	45	SCD231-1030-2-4-180HA05-HP230	30382841
10,40	12	116	69	54	45	SCD231-1040-2-4-180HA05-HP230	30382842
10,50	12	116	69	54	45	SCD231-1050-2-4-180HA05-HP230	30382843
10,60	12	116	69	54	45	SCD231-1060-2-4-180HA05-HP230	30382844
10,65	12	116	69	54	45	SCD231-1065-2-4-180HA05-HP230	31198519
10,80	12	116	69	54	45	SCD231-1080-2-4-180HA05-HP230	30382846
11,00	12	116	69	54	45	SCD231-1100-2-4-180HA05-HP230	30382848
11,20	12	116	69	54	45	SCD231-1120-2-4-180HA05-HP230	30382850
11,50	12	116	69	54	45	SCD231-1150-2-4-180HA05-HP230	30382853
11,60	12	116	69	54	45	SCD231-1160-2-4-180HA05-HP230	30382854
11,70	12	116	69	54	45	SCD231-1170-2-4-180HA05-HP230	30382855
11,80	12	116	69	54	45	SCD231-1180-2-4-180HA05-HP230	30382856
12,00	12	116	69	54	45	SCD231-1200-2-4-180HA05-HP230	30382858
12,50	14	122	75	58	45	SCD231-1250-2-4-180HA05-HP230	30382859
12,80	14	122	75	58	45	SCD231-1280-2-4-180HA05-HP230	30382860
13,00	14	122	75	58	45	SCD231-1300-2-4-180HA05-HP230	30382861
13,50	14	122	75	58	45	SCD231-1350-2-4-180HA05-HP230	30382862
13,80	14	122	75	58	45	SCD231-1380-2-4-180HA05-HP230	30382863
14,00	14	122	75	58	45	SCD231-1400-2-4-180HA05-HP230	30382864
14,50	16	131	81	61	48	SCD231-1450-2-4-180HA05-HP230	30382865

Fortsetzung auf nächster Seite.

MEGA-180°-Drill | Vollhartmetall-Spiralbohrer SCD231 (5xD), innere Kühlmittelzufuhr

Baumaße						Schaftform HA	
d ₁ m7	d ₂ h6	l ₁	l ₂	l ₃	l ₄	Spezifikation	Bestell-Nr.
14,80	16	131	81	61	48	SCD231-1480-2-4-180HA05-HP230	30382866
15,00	16	131	81	61	48	SCD231-1500-2-4-180HA05-HP230	30382867
15,50	16	131	81	61	48	SCD231-1550-2-4-180HA05-HP230	30382868
15,80	16	131	81	61	48	SCD231-1580-2-4-180HA05-HP230	30382869
16,00	16	131	81	61	48	SCD231-1600-2-4-180HA05-HP230	30382870
16,50	18	141	91	69	48	SCD231-1650-2-4-180HA05-HP230	30382871
17,00	18	141	91	69	48	SCD231-1700-2-4-180HA05-HP230	30382873
17,50	18	141	91	69	48	SCD231-1750-2-4-180HA05-HP230	30382874
17,80	18	141	91	69	48	SCD231-1780-2-4-180HA05-HP230	30382875
18,00	18	141	91	69	48	SCD231-1800-2-4-180HA05-HP230	30382876
18,50	20	151	99	75	50	SCD231-1850-2-4-180HA05-HP230	30382877
19,00	20	151	99	75	50	SCD231-1900-2-4-180HA05-HP230	30382879
19,80	20	151	99	75	50	SCD231-1980-2-4-180HA05-HP230	30382881
20,00	20	151	99	75	50	SCD231-2000-2-4-180HA05-HP230	30382882

Konfigurierbare Merkmale



Durchmesser:
Durchmesser in Abstufungen von 0,01 mm frei wählbar



Schaftform:
Schaftform: HB | HE

Spezifikation:
SCD231-[Durchmesser]-2-4-180[Schaftform]05-HP230

Abmessungen konfigurierbare Baureihe

d ₁ min.	d ₁ max.	d ₂ h6	l ₁	l ₂	l ₃	l ₄
3,00	3,70	6	66	28	23	36
3,71	4,70	6	74	36	29	36
4,71	6,00	6	82	44	35	36
6,01	8,00	8	91	53	43	36
8,01	10,00	10	103	61	49	40
10,01	12,00	12	116	69	54	45
12,01	14,00	14	122	75	58	45
14,01	16,00	16	131	81	61	48
16,01	18,00	18	141	91	69	48
18,01	20,00	20	151	99	75	50

Beispiel:
SCD231-0431-2-4-180HE05-HP230

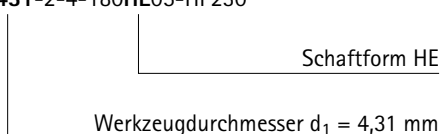

Maßangaben in mm.
Schnittwertempfehlung siehe Kapitelende.
Sonderausführungen und andere Beschichtungen auf Anfrage.

ECU-Drill-Steel

Vollhartmetall-Spiralbohrer
SCD361 (3xD), innere Kühlmittelzufuhr

Ausführung:

Bohrerdurchmesser: 3,00 - 20,00 mm
Bohrungstoleranz: \geq IT 9
Schneidstoff: HP132
Schneidenanzahl: 2
Spitzenwinkel: 140°
Spiralwinkel: 30°

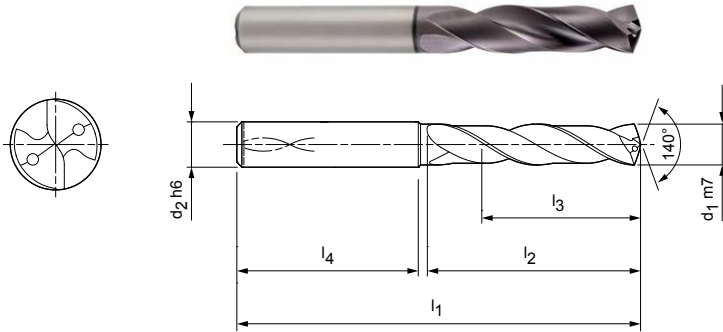

Lagerhaltige Vorzugsbaureihe in Schaftform HA

Baumaße						Schaftform HA	
d ₁ m7	d ₂ h6	l ₁	l ₂	l ₃	l ₄	Spezifikation	Bestell-Nr.
3,00	6	62	20	14	36	SCD361-0300-2-2-140HA03-HP132	30421364
3,10	6	62	20	14	36	SCD361-0310-2-2-140HA03-HP132	30421365
3,20	6	62	20	14	36	SCD361-0320-2-2-140HA03-HP132	30421366
3,30	6	62	20	14	36	SCD361-0330-2-2-140HA03-HP132	30421368
3,40	6	62	20	14	36	SCD361-0340-2-2-140HA03-HP132	30421369
3,50	6	62	20	14	36	SCD361-0350-2-2-140HA03-HP132	30421370
3,70*	6	62	20	14	36	SCD361-0370-2-2-140HA03-HP132	30421372
3,80	6	66	24	17	36	SCD361-0380-2-2-140HA03-HP132	30421373
3,90	6	66	24	17	36	SCD361-0390-2-2-140HA03-HP132	30421374
4,00	6	66	24	17	36	SCD361-0400-2-2-140HA03-HP132	30421375
4,10	6	66	24	17	36	SCD361-0410-2-2-140HA03-HP132	30421376
4,20	6	66	24	17	36	SCD361-0420-2-2-140HA03-HP132	30421377
4,30	6	66	24	17	36	SCD361-0430-2-2-140HA03-HP132	30421379
4,40	6	66	24	17	36	SCD361-0440-2-2-140HA03-HP132	30421380
4,50	6	66	24	17	36	SCD361-0450-2-2-140HA03-HP132	30421381
4,60	6	66	24	17	36	SCD361-0460-2-2-140HA03-HP132	30421382
4,65*	6	66	24	17	36	SCD361-0465-2-2-140HA03-HP132	30421383
4,70	6	66	24	17	36	SCD361-0470-2-2-140HA03-HP132	30421384
4,80	6	66	28	20	36	SCD361-0480-2-2-140HA03-HP132	30421385
4,90	6	66	28	20	36	SCD361-0490-2-2-140HA03-HP132	30421386
5,00	6	66	28	20	36	SCD361-0500-2-2-140HA03-HP132	30421388
5,10	6	66	28	20	36	SCD361-0510-2-2-140HA03-HP132	30421390
5,20	6	66	28	20	36	SCD361-0520-2-2-140HA03-HP132	30421391
5,30	6	66	28	20	36	SCD361-0530-2-2-140HA03-HP132	30421392
5,40	6	66	28	20	36	SCD361-0540-2-2-140HA03-HP132	30421393
5,50	6	66	28	20	36	SCD361-0550-2-2-140HA03-HP132	30421394
5,55*	6	66	28	20	36	SCD361-0555-2-2-140HA03-HP132	30421395
5,60	6	66	28	20	36	SCD361-0560-2-2-140HA03-HP132	30421396
5,80	6	66	28	20	36	SCD361-0580-2-2-140HA03-HP132	30421399
5,90	6	66	28	20	36	SCD361-0590-2-2-140HA03-HP132	30421400
6,00	6	66	28	20	36	SCD361-0600-2-2-140HA03-HP132	30421401
6,10	8	79	34	24	36	SCD361-0610-2-2-140HA03-HP132	30421402
6,20	8	79	34	24	36	SCD361-0620-2-2-140HA03-HP132	30421403
6,30	8	79	34	24	36	SCD361-0630-2-2-140HA03-HP132	30421404
6,40	8	79	34	24	36	SCD361-0640-2-2-140HA03-HP132	30421405

ECU-Drill-Steel | Vollhartmetall-Spiralbohrer SCD361 (3xD), innere Kühlmittelzufuhr

Baumaße						Schaftform HA	
d ₁ m7	d ₂ h6	l ₁	l ₂	l ₃	l ₄	Spezifikation	Bestell-Nr.
6,50	8	79	34	24	36	SCD361-0650-2-2-140HA03-HP132	30421406
6,60	8	79	34	24	36	SCD361-0660-2-2-140HA03-HP132	30421407
6,70	8	79	34	24	36	SCD361-0670-2-2-140HA03-HP132	30421408
6,80	8	79	34	24	36	SCD361-0680-2-2-140HA03-HP132	30421409
6,90	8	79	34	24	36	SCD361-0690-2-2-140HA03-HP132	30421410
7,00	8	79	34	24	36	SCD361-0700-2-2-140HA03-HP132	30421411
7,10	8	79	41	29	36	SCD361-0710-2-2-140HA03-HP132	30421412
7,20	8	79	41	29	36	SCD361-0720-2-2-140HA03-HP132	30421413
7,40	8	79	41	29	36	SCD361-0740-2-2-140HA03-HP132	30421415
7,45*	8	79	41	29	36	SCD361-0745-2-2-140HA03-HP132	30421416
7,50	8	79	41	29	36	SCD361-0750-2-2-140HA03-HP132	30421417
7,70	8	79	41	29	36	SCD361-0770-2-2-140HA03-HP132	30421420
7,80	8	79	41	29	36	SCD361-0780-2-2-140HA03-HP132	30421421
7,90	8	79	41	29	36	SCD361-0790-2-2-140HA03-HP132	30421422
8,00	8	79	41	29	36	SCD361-0800-2-2-140HA03-HP132	30421423
8,10	10	89	47	35	40	SCD361-0810-2-2-140HA03-HP132	30421424
8,20	10	89	47	35	40	SCD361-0820-2-2-140HA03-HP132	30421425
8,30	10	89	47	35	40	SCD361-0830-2-2-140HA03-HP132	30421426
8,40	10	89	47	35	40	SCD361-0840-2-2-140HA03-HP132	30421427
8,50	10	89	47	35	40	SCD361-0850-2-2-140HA03-HP132	30421428
8,60	10	89	47	35	40	SCD361-0860-2-2-140HA03-HP132	30421429
8,70	10	89	47	35	40	SCD361-0870-2-2-140HA03-HP132	30421430
8,80	10	89	47	35	40	SCD361-0880-2-2-140HA03-HP132	30421431
8,90	10	89	47	35	40	SCD361-0890-2-2-140HA03-HP132	30421432
9,00	10	89	47	35	40	SCD361-0900-2-2-140HA03-HP132	30421433
9,10	10	89	47	35	40	SCD361-0910-2-2-140HA03-HP132	30421434
9,20	10	89	47	35	40	SCD361-0920-2-2-140HA03-HP132	30421435
9,30*	10	89	47	35	40	SCD361-0930-2-2-140HA03-HP132	30421437
9,35	10	89	47	35	40	SCD361-0935-2-2-140HA03-HP132	30421438
9,40	10	89	47	35	40	SCD361-0940-2-2-140HA03-HP132	30421439
9,50	10	89	47	35	40	SCD361-0950-2-2-140HA03-HP132	30421440
9,60	10	89	47	35	40	SCD361-0960-2-2-140HA03-HP132	30421441
9,80	10	89	47	35	40	SCD361-0980-2-2-140HA03-HP132	30421443
9,90	10	89	47	35	40	SCD361-0990-2-2-140HA03-HP132	30421445
10,00	10	89	47	35	40	SCD361-1000-2-2-140HA03-HP132	30421446
10,10	12	102	55	40	45	SCD361-1010-2-2-140HA03-HP132	30421447
10,20	12	102	55	40	45	SCD361-1020-2-2-140HA03-HP132	30421448
10,30	12	102	55	40	45	SCD361-1030-2-2-140HA03-HP132	30421449
10,40	12	102	55	40	45	SCD361-1040-2-2-140HA03-HP132	30421450
10,50	12	102	55	40	45	SCD361-1050-2-2-140HA03-HP132	30421451
10,60	12	102	55	40	45	SCD361-1060-2-2-140HA03-HP132	30421453
10,70	12	102	55	40	45	SCD361-1070-2-2-140HA03-HP132	30421454
10,80	12	102	55	40	45	SCD361-1080-2-2-140HA03-HP132	30421456
10,90	12	102	55	40	45	SCD361-1090-2-2-140HA03-HP132	30421457
11,00	12	102	55	40	45	SCD361-1100-2-2-140HA03-HP132	30421458
11,10	12	102	55	40	45	SCD361-1110-2-2-140HA03-HP132	30421459
11,20*	12	102	55	40	45	SCD361-1120-2-2-140HA03-HP132	30421460
11,40	12	102	55	40	45	SCD361-1140-2-2-140HA03-HP132	30421463
11,50	12	102	55	40	45	SCD361-1150-2-2-140HA03-HP132	30421464
11,70	12	102	55	40	45	SCD361-1170-2-2-140HA03-HP132	30421466
11,80	12	102	55	40	45	SCD361-1180-2-2-140HA03-HP132	30421467
12,00	12	102	55	40	45	SCD361-1200-2-2-140HA03-HP132	30421469
12,25	14	107	60	43	45	SCD361-1225-2-2-140HA03-HP132	30421470
12,50	14	107	60	43	45	SCD361-1250-2-2-140HA03-HP132	30421471
12,70	14	107	60	43	45	SCD361-1270-2-2-140HA03-HP132	30421472
12,80	14	107	60	43	45	SCD361-1280-2-2-140HA03-HP132	30421473
12,90	14	107	60	43	45	SCD361-1290-2-2-140HA03-HP132	30421474

ECU-Drill-Steel | Vollhartmetall-Spiralbohrer SCD361 (3xD), innere Kühlmittelzufuhr

Baumaße						Schaftform HA	
d ₁ m7	d ₂ h6	l ₁	l ₂	l ₃	l ₄	Spezifikation	Bestell-Nr.
13,00	14	107	60	43	45	SCD361-1300-2-2-140HA03-HP132	30421475
13,10	14	107	60	43	45	SCD361-1310-2-2-140HA03-HP132	30421476
13,20	14	107	60	43	45	SCD361-1320-2-2-140HA03-HP132	30421477
13,50	14	107	60	43	45	SCD361-1350-2-2-140HA03-HP132	30421479
13,80	14	107	60	43	45	SCD361-1380-2-2-140HA03-HP132	30421481
14,00	14	107	60	43	45	SCD361-1400-2-2-140HA03-HP132	30421482
14,20	16	115	65	45	48	SCD361-1420-2-2-140HA03-HP132	30421483
14,50	16	115	65	45	48	SCD361-1450-2-2-140HA03-HP132	30421484
14,80	16	115	65	45	48	SCD361-1480-2-2-140HA03-HP132	30421487
15,00	16	115	65	45	48	SCD361-1500-2-2-140HA03-HP132	30421488
15,10	16	115	65	45	48	SCD361-1510-2-2-140HA03-HP132	30421489
15,25	16	115	65	45	48	SCD361-1525-2-2-140HA03-HP132	30421490
15,30	16	115	65	45	48	SCD361-1530-2-2-140HA03-HP132	30421491
15,50	16	115	65	45	48	SCD361-1550-2-2-140HA03-HP132	30421493
15,80	16	115	65	45	48	SCD361-1580-2-2-140HA03-HP132	30421496
16,00	16	115	65	45	48	SCD361-1600-2-2-140HA03-HP132	30421497
16,50	18	123	73	51	48	SCD361-1650-2-2-140HA03-HP132	30421498
16,80	18	123	73	51	48	SCD361-1680-2-2-140HA03-HP132	30421499
17,00	18	123	73	51	48	SCD361-1700-2-2-140HA03-HP132	30421501
17,50	18	123	73	51	48	SCD361-1750-2-2-140HA03-HP132	30421502
17,80	18	123	73	51	48	SCD361-1780-2-2-140HA03-HP132	30421504
18,00	18	123	73	51	48	SCD361-1800-2-2-140HA03-HP132	30421505
18,50	20	131	79	55	50	SCD361-1850-2-2-140HA03-HP132	30421506
19,00	20	131	79	55	50	SCD361-1900-2-2-140HA03-HP132	30421509
19,80	20	131	79	55	50	SCD361-1980-2-2-140HA03-HP132	30421512
20,00	20	131	79	55	50	SCD361-2000-2-2-140HA03-HP132	30421513

Konfigurierbare Merkmale



Schaftform:
Schaftform: HB | HE

**Spezifikation:**

SCD361-0430-2-2-140[Schaftform]03-HP132

Beispiel:

SCD361-0430-2-2-140HE03-HP132

Schaftform HE

Maßangaben in mm.

* Speziell zur Vorfertigung der Kernlöcher für Gewindeformer geeignet.

Schnittwertempfehlung siehe Kapitelende.

Sonderausführungen und andere Beschichtungen auf Anfrage.

ECU-Drill-Steel

Vollhartmetall-Spiralbohrer
SCD360 (3xD), äußere Kühlmittelzufuhr

Ausführung:

Bohrerdurchmesser: 3,00 - 20,00 mm
Bohrungstoleranz: ≥ IT 9
Schneidstoff: HP132
Schneidenanzahl: 2
Spitzenwinkel: 140°
Spiralwinkel: 30°

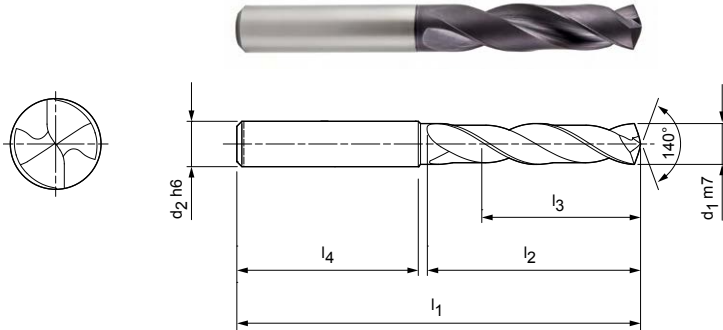

Lagerhaltige Vorzugsbaureihe in Schaftform HA

Baumaße						Schaftform HA	
d ₁ m7	d ₂ h6	l ₁	l ₂	l ₃	l ₄	Spezifikation	Bestell-Nr.
3,00	6	62	20	14	36	SCD360-0300-2-2-140HA03-HP132	30421215
3,10	6	62	20	14	36	SCD360-0310-2-2-140HA03-HP132	30421216
3,20	6	62	20	14	36	SCD360-0320-2-2-140HA03-HP132	30421217
3,30	6	62	20	14	36	SCD360-0330-2-2-140HA03-HP132	30421218
3,40	6	62	20	14	36	SCD360-0340-2-2-140HA03-HP132	30421219
3,50	6	62	20	14	36	SCD360-0350-2-2-140HA03-HP132	30421220
3,60	6	62	20	14	36	SCD360-0360-2-2-140HA03-HP132	30421221
3,70*	6	62	20	14	36	SCD360-0370-2-2-140HA03-HP132	30421222
3,80	6	66	24	17	36	SCD360-0380-2-2-140HA03-HP132	30421223
3,90	6	66	24	17	36	SCD360-0390-2-2-140HA03-HP132	30421224
4,00	6	66	24	17	36	SCD360-0400-2-2-140HA03-HP132	30421225
4,02	6	66	24	17	36	SCD360-0402-2-2-140HA03-HP132	30421226
4,10	6	66	24	17	36	SCD360-0410-2-2-140HA03-HP132	30421227
4,20	6	66	24	17	36	SCD360-0420-2-2-140HA03-HP132	30421228
4,30	6	66	24	17	36	SCD360-0430-2-2-140HA03-HP132	30421229
4,40	6	66	24	17	36	SCD360-0440-2-2-140HA03-HP132	30421230
4,50	6	66	24	17	36	SCD360-0450-2-2-140HA03-HP132	30421231
4,60	6	66	24	17	36	SCD360-0460-2-2-140HA03-HP132	30421232
4,65*	6	66	24	17	36	SCD360-0465-2-2-140HA03-HP132	30421233
4,70	6	66	24	17	36	SCD360-0470-2-2-140HA03-HP132	30421234
4,80	6	66	28	20	36	SCD360-0480-2-2-140HA03-HP132	30421235
4,90	6	66	28	20	36	SCD360-0490-2-2-140HA03-HP132	30421236
5,00	6	66	28	20	36	SCD360-0500-2-2-140HA03-HP132	30421237
5,10	6	66	28	20	36	SCD360-0510-2-2-140HA03-HP132	30421238
5,20	6	66	28	20	36	SCD360-0520-2-2-140HA03-HP132	30421240
5,30	6	66	28	20	36	SCD360-0530-2-2-140HA03-HP132	30421241
5,40	6	66	28	20	36	SCD360-0540-2-2-140HA03-HP132	30421242
5,50	6	66	28	20	36	SCD360-0550-2-2-140HA03-HP132	30421243
5,55*	6	66	28	20	36	SCD360-0555-2-2-140HA03-HP132	30421244
5,60	6	66	28	20	36	SCD360-0560-2-2-140HA03-HP132	30421245
5,70	6	66	28	20	36	SCD360-0570-2-2-140HA03-HP132	30421246
5,80	6	66	28	20	36	SCD360-0580-2-2-140HA03-HP132	30421247
5,90	6	66	28	20	36	SCD360-0590-2-2-140HA03-HP132	30421248
6,00	6	66	28	20	36	SCD360-0600-2-2-140HA03-HP132	30421249
6,10	8	79	34	24	36	SCD360-0610-2-2-140HA03-HP132	30421250

ECU-Drill-Steel | Vollhartmetall-Spiralbohrer SCD360 (3xD), äußere Kühlmittelzufuhr

Baumaße						Schaftform HA	
d ₁ m7	d ₂ h6	l ₁	l ₂	l ₃	l ₄	Spezifikation	Bestell-Nr.
6,20	8	79	34	24	36	SCD360-0620-2-2-140HA03-HP132	30421251
6,30	8	79	34	24	36	SCD360-0630-2-2-140HA03-HP132	30421252
6,40	8	79	34	24	36	SCD360-0640-2-2-140HA03-HP132	30421253
6,50	8	79	34	24	36	SCD360-0650-2-2-140HA03-HP132	30421254
6,60	8	79	34	24	36	SCD360-0660-2-2-140HA03-HP132	30421255
6,70	8	79	34	24	36	SCD360-0670-2-2-140HA03-HP132	30421256
6,80	8	79	34	24	36	SCD360-0680-2-2-140HA03-HP132	30421257
6,90	8	79	34	24	36	SCD360-0690-2-2-140HA03-HP132	30421258
7,00	8	79	34	24	36	SCD360-0700-2-2-140HA03-HP132	30421259
7,10	8	79	41	29	36	SCD360-0710-2-2-140HA03-HP132	30421260
7,20	8	79	41	29	36	SCD360-0720-2-2-140HA03-HP132	30421261
7,30	8	79	41	29	36	SCD360-0730-2-2-140HA03-HP132	30421262
7,40	8	79	41	29	36	SCD360-0740-2-2-140HA03-HP132	30421263
7,50	8	79	41	29	36	SCD360-0750-2-2-140HA03-HP132	30421264
7,60	8	79	41	29	36	SCD360-0760-2-2-140HA03-HP132	30421266
7,70	8	79	41	29	36	SCD360-0770-2-2-140HA03-HP132	30421267
7,80	8	79	41	29	36	SCD360-0780-2-2-140HA03-HP132	30421268
7,90	8	79	41	29	36	SCD360-0790-2-2-140HA03-HP132	30421269
8,00	8	79	41	29	36	SCD360-0800-2-2-140HA03-HP132	30421270
8,10	10	89	47	35	40	SCD360-0810-2-2-140HA03-HP132	30421271
8,20	10	89	47	35	40	SCD360-0820-2-2-140HA03-HP132	30421272
8,30	10	89	47	35	40	SCD360-0830-2-2-140HA03-HP132	30421273
8,40	10	89	47	35	40	SCD360-0840-2-2-140HA03-HP132	30421274
8,50	10	89	47	35	40	SCD360-0850-2-2-140HA03-HP132	30421275
8,60	10	89	47	35	40	SCD360-0860-2-2-140HA03-HP132	30421276
8,70	10	89	47	35	40	SCD360-0870-2-2-140HA03-HP132	30421277
8,80	10	89	47	35	40	SCD360-0880-2-2-140HA03-HP132	30421278
8,90	10	89	47	35	40	SCD360-0890-2-2-140HA03-HP132	30421279
9,00	10	89	47	35	40	SCD360-0900-2-2-140HA03-HP132	30421280
9,10	10	89	47	35	40	SCD360-0910-2-2-140HA03-HP132	30421281
9,20	10	89	47	35	40	SCD360-0920-2-2-140HA03-HP132	30421282
9,30*	10	89	47	35	40	SCD360-0930-2-2-140HA03-HP132	30421284
9,40	10	89	47	35	40	SCD360-0940-2-2-140HA03-HP132	30421285
9,50	10	89	47	35	40	SCD360-0950-2-2-140HA03-HP132	30421286
9,60	10	89	47	35	40	SCD360-0960-2-2-140HA03-HP132	30421287
9,70	10	89	47	35	40	SCD360-0970-2-2-140HA03-HP132	30421288
9,80	10	89	47	35	40	SCD360-0980-2-2-140HA03-HP132	30421289
9,90	10	89	47	35	40	SCD360-0990-2-2-140HA03-HP132	30421290
10,00	10	89	47	35	40	SCD360-1000-2-2-140HA03-HP132	30421291
10,10	12	102	55	40	45	SCD360-1010-2-2-140HA03-HP132	30421292
10,20	12	102	55	40	45	SCD360-1020-2-2-140HA03-HP132	30421293
10,30	12	102	55	40	45	SCD360-1030-2-2-140HA03-HP132	30421294
10,40	12	102	55	40	45	SCD360-1040-2-2-140HA03-HP132	30421295
10,50	12	102	55	40	45	SCD360-1050-2-2-140HA03-HP132	30421296
10,60	12	102	55	40	45	SCD360-1060-2-2-140HA03-HP132	30421297
10,70	12	102	55	40	45	SCD360-1070-2-2-140HA03-HP132	30421298
10,80	12	102	55	40	45	SCD360-1080-2-2-140HA03-HP132	30421300
10,90	12	102	55	40	45	SCD360-1090-2-2-140HA03-HP132	30421301
11,00	12	102	55	40	45	SCD360-1100-2-2-140HA03-HP132	30421302
11,10	12	102	55	40	45	SCD360-1110-2-2-140HA03-HP132	30421303
11,20*	12	102	55	40	45	SCD360-1120-2-2-140HA03-HP132	30421304
11,30	12	102	55	40	45	SCD360-1130-2-2-140HA03-HP132	30421305
11,40	12	102	55	40	45	SCD360-1140-2-2-140HA03-HP132	30421306
11,50	12	102	55	40	45	SCD360-1150-2-2-140HA03-HP132	30421307
11,60	12	102	55	40	45	SCD360-1160-2-2-140HA03-HP132	30421308
11,70	12	102	55	40	45	SCD360-1170-2-2-140HA03-HP132	30421309
11,80	12	102	55	40	45	SCD360-1180-2-2-140HA03-HP132	30421310

Fortsetzung auf nächster Seite.

ECU-Drill-Steel | Vollhartmetall-Spiralbohrer SCD360 (3xD), äußere Kühlmittelzufuhr

Baumaße						Schaftform HA	
d ₁ m7	d ₂ h6	l ₁	l ₂	l ₃	l ₄	Spezifikation	Bestell-Nr.
11,90	12	102	55	40	45	SCD360-1190-2-2-140HA03-HP132	30421312
12,00	12	102	55	40	45	SCD360-1200-2-2-140HA03-HP132	30421313
12,20	14	107	60	43	45	SCD360-1220-2-2-140HA03-HP132	30569112
12,25	14	107	60	43	45	SCD360-1225-2-2-140HA03-HP132	30421314
12,50	14	107	60	43	45	SCD360-1250-2-2-140HA03-HP132	30421316
12,70	14	107	60	43	45	SCD360-1270-2-2-140HA03-HP132	30421317
12,80	14	107	60	43	45	SCD360-1280-2-2-140HA03-HP132	30421318
13,00	14	107	60	43	45	SCD360-1300-2-2-140HA03-HP132	30421320
13,30	14	107	60	43	45	SCD360-1330-2-2-140HA03-HP132	30421323
13,50	14	107	60	43	45	SCD360-1350-2-2-140HA03-HP132	30421324
13,70	14	107	60	43	45	SCD360-1370-2-2-140HA03-HP132	30421325
13,80	14	107	60	43	45	SCD360-1380-2-2-140HA03-HP132	30421326
14,00	14	107	60	43	45	SCD360-1400-2-2-140HA03-HP132	30421327
14,20	16	115	65	45	48	SCD360-1420-2-2-140HA03-HP132	30421328
14,50	16	115	65	45	48	SCD360-1450-2-2-140HA03-HP132	30421330
14,70	16	115	65	45	48	SCD360-1470-2-2-140HA03-HP132	30421331
15,00	16	115	65	45	48	SCD360-1500-2-2-140HA03-HP132	30421333
15,25	16	115	65	45	48	SCD360-1525-2-2-140HA03-HP132	30421335
15,30	16	115	65	45	48	SCD360-1530-2-2-140HA03-HP132	30421336
15,50	16	115	65	45	48	SCD360-1550-2-2-140HA03-HP132	30421337
15,80	16	115	65	45	48	SCD360-1580-2-2-140HA03-HP132	30421339
16,00	16	115	65	45	48	SCD360-1600-2-2-140HA03-HP132	30421340
16,50	18	123	73	51	48	SCD360-1650-2-2-140HA03-HP132	30421341
16,80	18	123	73	51	48	SCD360-1680-2-2-140HA03-HP132	30421342
17,00	18	123	73	51	48	SCD360-1700-2-2-140HA03-HP132	30421343
17,50	18	123	73	51	48	SCD360-1750-2-2-140HA03-HP132	30421344
17,80	18	123	73	51	48	SCD360-1780-2-2-140HA03-HP132	30421345
18,00	18	123	73	51	48	SCD360-1800-2-2-140HA03-HP132	30421346
18,50	20	131	79	55	50	SCD360-1850-2-2-140HA03-HP132	30421347
19,00	20	131	79	55	50	SCD360-1900-2-2-140HA03-HP132	30421349
19,50	20	131	79	55	50	SCD360-1950-2-2-140HA03-HP132	30421350
19,80	20	131	79	55	50	SCD360-1980-2-2-140HA03-HP132	30421351
20,00	20	131	79	55	50	SCD360-2000-2-2-140HA03-HP132	30421352

Konfigurierbare Merkmale



Schaftform:
Schaftform: HB | HE

**Spezifikation:**

SCD360-0430-2-2-140[**Schaftform**]05-HP132

Beispiel:

SCD360-0430-2-2-140HE05-HP132

Schaftform HE

Maßangaben in mm.

* Speziell zur Vorfertigung der Kernlöcher für Gewindeformer geeignet.

Schnittwertempfehlung siehe Kapitelende.

Sonderausführungen und andere Beschichtungen auf Anfrage.

ECU-Drill-Steel

Vollhartmetall-Spiralbohrer
SCD361 (5xD), innere Kühlmittelzufuhr

Ausführung:

Bohrerdurchmesser: 3,00 - 20,00 mm
Bohrungstoleranz: \geq IT 9
Schneidstoff: HP132
Schneidenanzahl: 2
Spitzenwinkel: 140°
Spiralwinkel: 30°

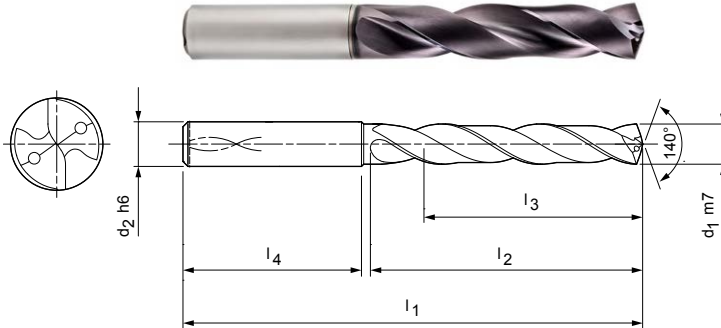

Lagerhaltige Vorzugsbaureihe in Schaftform HA

Baumaße						Schaftform HA	
d ₁ m7	d ₂ h6	l ₁	l ₂	l ₃	l ₄	Spezifikation	Bestell-Nr.
3,00	6	66	28	23	36	SCD361-0300-2-2-140HA05-HP132	30421524
3,10	6	66	28	23	36	SCD361-0310-2-2-140HA05-HP132	30421525
3,20	6	66	28	23	36	SCD361-0320-2-2-140HA05-HP132	30421526
3,30	6	66	28	23	36	SCD361-0330-2-2-140HA05-HP132	30421528
3,40	6	66	28	23	36	SCD361-0340-2-2-140HA05-HP132	30421529
3,50	6	66	28	23	36	SCD361-0350-2-2-140HA05-HP132	30421530
3,60	6	66	28	23	36	SCD361-0360-2-2-140HA05-HP132	30421531
3,70*	6	66	28	23	36	SCD361-0370-2-2-140HA05-HP132	30421532
3,80	6	74	36	29	36	SCD361-0380-2-2-140HA05-HP132	30421533
3,90	6	74	36	29	36	SCD361-0390-2-2-140HA05-HP132	30421534
4,00	6	74	36	29	36	SCD361-0400-2-2-140HA05-HP132	30421535
4,10	6	74	36	29	36	SCD361-0410-2-2-140HA05-HP132	30421536
4,20	6	74	36	29	36	SCD361-0420-2-2-140HA05-HP132	30421537
4,30	6	74	36	29	36	SCD361-0430-2-2-140HA05-HP132	30421539
4,40	6	74	36	29	36	SCD361-0440-2-2-140HA05-HP132	30421540
4,50	6	74	36	29	36	SCD361-0450-2-2-140HA05-HP132	30421541
4,60	6	74	36	29	36	SCD361-0460-2-2-140HA05-HP132	30421542
4,65*	6	74	36	29	36	SCD361-0465-2-2-140HA05-HP132	30421543
4,70	6	74	36	29	36	SCD361-0470-2-2-140HA05-HP132	30421544
4,80	6	82	44	35	36	SCD361-0480-2-2-140HA05-HP132	30421545
4,90	6	82	44	35	36	SCD361-0490-2-2-140HA05-HP132	30421546
5,00	6	82	44	35	36	SCD361-0500-2-2-140HA05-HP132	30421548
5,10	6	82	44	35	36	SCD361-0510-2-2-140HA05-HP132	30421550
5,20	6	82	44	35	36	SCD361-0520-2-2-140HA05-HP132	30421551
5,30	6	82	44	35	36	SCD361-0530-2-2-140HA05-HP132	30421552
5,40	6	82	44	35	36	SCD361-0540-2-2-140HA05-HP132	30421553
5,50	6	82	44	35	36	SCD361-0550-2-2-140HA05-HP132	30421554
5,55*	6	82	44	35	36	SCD361-0555-2-2-140HA05-HP132	30421555
5,60	6	82	44	35	36	SCD361-0560-2-2-140HA05-HP132	30421556
5,70	6	82	44	35	36	SCD361-0570-2-2-140HA05-HP132	30421557
5,80	6	82	44	35	36	SCD361-0580-2-2-140HA05-HP132	30421559
5,90	6	82	44	35	36	SCD361-0590-2-2-140HA05-HP132	30421560
6,00	6	82	44	35	36	SCD361-0600-2-2-140HA05-HP132	30421561
6,10	8	91	53	43	36	SCD361-0610-2-2-140HA05-HP132	30421562
6,20	8	91	53	43	36	SCD361-0620-2-2-140HA05-HP132	30421563

Fortsetzung auf nächster Seite.

ECU-Drill-Steel | Vollhartmetall-Spiralbohrer SCD361 (5xD), innere Kühlmittelzufuhr

Baumaße						Schaftform HA	
d ₁ m7	d ₂ h6	l ₁	l ₂	l ₃	l ₄	Spezifikation	Bestell-Nr.
6,30	8	91	53	43	36	SCD361-0630-2-2-140HA05-HP132	30421564
6,40	8	91	53	43	36	SCD361-0640-2-2-140HA05-HP132	30421565
6,50	8	91	53	43	36	SCD361-0650-2-2-140HA05-HP132	30421566
6,60	8	91	53	43	36	SCD361-0660-2-2-140HA05-HP132	30421567
6,70	8	91	53	43	36	SCD361-0670-2-2-140HA05-HP132	30421568
6,80	8	91	53	43	36	SCD361-0680-2-2-140HA05-HP132	30421569
6,90	8	91	53	43	36	SCD361-0690-2-2-140HA05-HP132	30421570
7,00	8	91	53	43	36	SCD361-0700-2-2-140HA05-HP132	30421571
7,10	8	91	53	43	36	SCD361-0710-2-2-140HA05-HP132	30421572
7,20	8	91	53	43	36	SCD361-0720-2-2-140HA05-HP132	30421573
7,30	8	91	53	43	36	SCD361-0730-2-2-140HA05-HP132	30421574
7,40	8	91	53	43	36	SCD361-0740-2-2-140HA05-HP132	30421575
7,45*	8	91	53	43	36	SCD361-0745-2-2-140HA05-HP132	30421576
7,50	8	91	53	43	36	SCD361-0750-2-2-140HA05-HP132	30421577
7,60	8	91	53	43	36	SCD361-0760-2-2-140HA05-HP132	30421579
7,70	8	91	53	43	36	SCD361-0770-2-2-140HA05-HP132	30421580
7,80	8	91	53	43	36	SCD361-0780-2-2-140HA05-HP132	30421581
7,90	8	91	53	43	36	SCD361-0790-2-2-140HA05-HP132	30421582
8,00	8	91	53	43	36	SCD361-0800-2-2-140HA05-HP132	30421583
8,10	10	103	61	49	40	SCD361-0810-2-2-140HA05-HP132	30421584
8,20	10	103	61	49	40	SCD361-0820-2-2-140HA05-HP132	30421585
8,30	10	103	61	49	40	SCD361-0830-2-2-140HA05-HP132	30421586
8,40	10	103	61	49	40	SCD361-0840-2-2-140HA05-HP132	30421587
8,50	10	103	61	49	40	SCD361-0850-2-2-140HA05-HP132	30421588
8,60	10	103	61	49	40	SCD361-0860-2-2-140HA05-HP132	30421589
8,70	10	103	61	49	40	SCD361-0870-2-2-140HA05-HP132	30421590
8,80	10	103	61	49	40	SCD361-0880-2-2-140HA05-HP132	30421591
8,90	10	103	61	49	40	SCD361-0890-2-2-140HA05-HP132	30421592
9,00	10	103	61	49	40	SCD361-0900-2-2-140HA05-HP132	30421593
9,10	10	103	61	49	40	SCD361-0910-2-2-140HA05-HP132	30421594
9,20	10	103	61	49	40	SCD361-0920-2-2-140HA05-HP132	30421595
9,30*	10	103	61	49	40	SCD361-0930-2-2-140HA05-HP132	30421597
9,35	10	103	61	49	40	SCD361-0935-2-2-140HA05-HP132	30421598
9,40	10	103	61	49	40	SCD361-0940-2-2-140HA05-HP132	30421599
9,50	10	103	61	49	40	SCD361-0950-2-2-140HA05-HP132	30421600
9,60	10	103	61	49	40	SCD361-0960-2-2-140HA05-HP132	30421601
9,70	10	103	61	49	40	SCD361-0970-2-2-140HA05-HP132	30421602
9,80	10	103	61	49	40	SCD361-0980-2-2-140HA05-HP132	30421603
9,90	10	103	61	49	40	SCD361-0990-2-2-140HA05-HP132	30421604
10,00	10	103	61	49	40	SCD361-1000-2-2-140HA05-HP132	30421605
10,10	12	118	71	56	45	SCD361-1010-2-2-140HA05-HP132	30421606
10,20	12	118	71	56	45	SCD361-1020-2-2-140HA05-HP132	30421607
10,30	12	118	71	56	45	SCD361-1030-2-2-140HA05-HP132	30421608
10,40	12	118	71	56	45	SCD361-1040-2-2-140HA05-HP132	30421609
10,50	12	118	71	56	45	SCD361-1050-2-2-140HA05-HP132	30421610
10,60	12	118	71	56	45	SCD361-1060-2-2-140HA05-HP132	30421612
10,70	12	118	71	56	45	SCD361-1070-2-2-140HA05-HP132	30421613
10,80	12	118	71	56	45	SCD361-1080-2-2-140HA05-HP132	30421615
10,90	12	118	71	56	45	SCD361-1090-2-2-140HA05-HP132	30421616
11,00	12	118	71	56	45	SCD361-1100-2-2-140HA05-HP132	30421617
11,10	12	118	71	56	45	SCD361-1110-2-2-140HA05-HP132	30421618
11,20*	12	118	71	56	45	SCD361-1120-2-2-140HA05-HP132	30421619
11,25	12	118	71	56	45	SCD361-1125-2-2-140HA05-HP132	30421620
11,30	12	118	71	56	45	SCD361-1130-2-2-140HA05-HP132	30421621
11,40	12	118	71	56	45	SCD361-1140-2-2-140HA05-HP132	30421622
11,50	12	118	71	56	45	SCD361-1150-2-2-140HA05-HP132	30421623
11,60	12	118	71	56	45	SCD361-1160-2-2-140HA05-HP132	30421624

ECU-Drill-Steel | Vollhartmetall-Spiralbohrer SCD361 (5xD), innere Kühlmittelzufuhr

Baumaße						Schaftform HA	
d ₁ m7	d ₂ h6	l ₁	l ₂	l ₃	l ₄	Spezifikation	Bestell-Nr.
11,70	12	118	71	56	45	SCD361-1170-2-2-140HA05-HP132	30421625
11,80	12	118	71	56	45	SCD361-1180-2-2-140HA05-HP132	30421626
11,90	12	118	71	56	45	SCD361-1190-2-2-140HA05-HP132	30421628
12,00	12	118	71	56	45	SCD361-1200-2-2-140HA05-HP132	30421629
12,20	14	124	77	60	45	SCD361-1220-2-2-140HA05-HP132	30569175
12,25	14	124	77	60	45	SCD361-1225-2-2-140HA05-HP132	30421630
12,50	14	124	77	60	45	SCD361-1250-2-2-140HA05-HP132	30421632
12,70	14	124	77	60	45	SCD361-1270-2-2-140HA05-HP132	30421633
12,80	14	124	77	60	45	SCD361-1280-2-2-140HA05-HP132	30421634
12,90	14	124	77	60	45	SCD361-1290-2-2-140HA05-HP132	30421635
13,00	14	124	77	60	45	SCD361-1300-2-2-140HA05-HP132	30421636
13,10	14	124	77	60	45	SCD361-1310-2-2-140HA05-HP132	30421637
13,20	14	124	77	60	45	SCD361-1320-2-2-140HA05-HP132	30421638
13,50	14	124	77	60	45	SCD361-1350-2-2-140HA05-HP132	30421640
13,70	14	124	77	60	45	SCD361-1370-2-2-140HA05-HP132	30421641
13,80	14	124	77	60	45	SCD361-1380-2-2-140HA05-HP132	30421642
14,00	14	124	77	60	45	SCD361-1400-2-2-140HA05-HP132	30421643
14,20	16	133	83	63	48	SCD361-1420-2-2-140HA05-HP132	30421644
14,50	16	133	83	63	48	SCD361-1450-2-2-140HA05-HP132	30421645
14,70	16	133	83	63	48	SCD361-1470-2-2-140HA05-HP132	30421646
14,80	16	133	83	63	48	SCD361-1480-2-2-140HA05-HP132	30421647
15,00	16	133	83	63	48	SCD361-1500-2-2-140HA05-HP132	30421648
15,10	16	133	83	63	48	SCD361-1510-2-2-140HA05-HP132	30421649
15,25	16	133	83	63	48	SCD361-1525-2-2-140HA05-HP132	30421650
15,30	16	133	83	63	48	SCD361-1530-2-2-140HA05-HP132	30421651
15,50	16	133	83	63	48	SCD361-1550-2-2-140HA05-HP132	30421652
15,70	16	133	83	63	48	SCD361-1570-2-2-140HA05-HP132	30421654
15,80	16	133	83	63	48	SCD361-1580-2-2-140HA05-HP132	30421655
16,00	16	133	83	63	48	SCD361-1600-2-2-140HA05-HP132	30421656
16,50	18	143	93	71	48	SCD361-1650-2-2-140HA05-HP132	30421657
16,80	18	143	93	71	48	SCD361-1680-2-2-140HA05-HP132	30421658
17,00	18	143	93	71	48	SCD361-1700-2-2-140HA05-HP132	30421660
17,50	18	143	93	71	48	SCD361-1750-2-2-140HA05-HP132	30421661
17,80	18	143	93	71	48	SCD361-1780-2-2-140HA05-HP132	30421663
18,00	18	143	93	71	48	SCD361-1800-2-2-140HA05-HP132	30421664
18,50	20	153	101	77	50	SCD361-1850-2-2-140HA05-HP132	30421665
18,80	20	153	101	77	50	SCD361-1880-2-2-140HA05-HP132	30421666
19,00	20	153	101	77	50	SCD361-1900-2-2-140HA05-HP132	30421668
19,50	20	153	101	77	50	SCD361-1950-2-2-140HA05-HP132	30421669
19,80	20	153	101	77	50	SCD361-1980-2-2-140HA05-HP132	30421671
20,00	20	153	101	77	50	SCD361-2000-2-2-140HA05-HP132	30421672

Fortsetzung auf nächster Seite.

ECU-Drill-Steel | Vollhartmetall-Spiralbohrer SCD361 (5xD), innere Kühlmittelzufuhr

Konfigurierbare Merkmale



Schaftform:
Schaftform: HB | HE

**Spezifikation:**

SCD361-0430-2-2-140[Schaftform]05-HP132

Beispiel:

SCD361-0430-2-2-140HE05-HP132

Schaftform HE

Maßangaben in mm.

* Speziell zur Vorfertigung der Kernlöcher für Gewindeformer geeignet.

Schnittwertempfehlung siehe Kapitelende.

Sonderausführungen und andere Beschichtungen auf Anfrage.

ECU-Drill-Steel

Vollhartmetall-Spiralbohrer
SCD360 (5xD), äußere Kühlmittelzufuhr

Ausführung:

Bohrerdurchmesser: 3,00 - 20,00 mm
Bohrungstoleranz: \geq IT 9
Schneidstoff: HP132
Schneidenanzahl: 2
Spitzenwinkel: 140°
Spiralwinkel: 30°

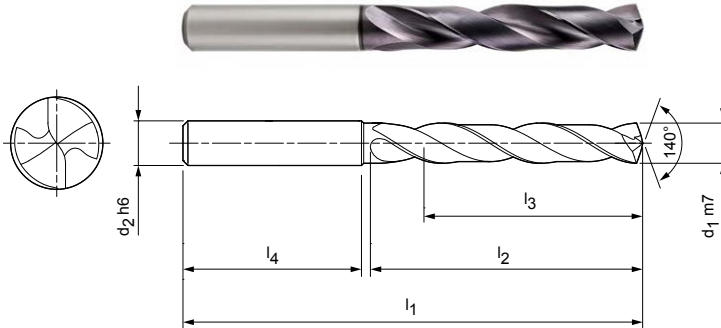

Lagerhaltige Vorzugsbaureihe in Schaftform HA

Baumaße						Schaftform HA	
d ₁ m7	d ₂ h6	l ₁	l ₂	l ₃	l ₄	Spezifikation	Bestell-Nr.
3,00	6	66	28	23	36	SCD360-0300-2-2-140HA05-HP132	30568692
3,10	6	66	28	23	36	SCD360-0310-2-2-140HA05-HP132	30568693
3,20	6	66	28	23	36	SCD360-0320-2-2-140HA05-HP132	30568694
3,30	6	66	28	23	36	SCD360-0330-2-2-140HA05-HP132	30568695
3,40	6	66	28	23	36	SCD360-0340-2-2-140HA05-HP132	30568696
3,50	6	66	28	23	36	SCD360-0350-2-2-140HA05-HP132	30568697
3,60	6	66	28	23	36	SCD360-0360-2-2-140HA05-HP132	30568698
3,70*	6	66	28	23	36	SCD360-0370-2-2-140HA05-HP132	30568699
3,80	6	74	36	29	36	SCD360-0380-2-2-140HA05-HP132	30568700
3,90	6	74	36	29	36	SCD360-0390-2-2-140HA05-HP132	30568701
4,00	6	74	36	29	36	SCD360-0400-2-2-140HA05-HP132	30568702
4,10	6	74	36	29	36	SCD360-0410-2-2-140HA05-HP132	30568703
4,20	6	74	36	29	36	SCD360-0420-2-2-140HA05-HP132	30568704
4,30	6	74	36	29	36	SCD360-0430-2-2-140HA05-HP132	30568705
4,40	6	74	36	29	36	SCD360-0440-2-2-140HA05-HP132	30568706
4,50	6	74	36	29	36	SCD360-0450-2-2-140HA05-HP132	30568707
4,60	6	74	36	29	36	SCD360-0460-2-2-140HA05-HP132	30568708
4,65*	6	74	36	29	36	SCD360-0465-2-2-140HA05-HP132	30568709
4,70	6	74	36	29	36	SCD360-0470-2-2-140HA05-HP132	30568710
4,80	6	82	44	35	36	SCD360-0480-2-2-140HA05-HP132	30568711
4,90	6	82	44	35	36	SCD360-0490-2-2-140HA05-HP132	30568712
5,00	6	82	44	35	36	SCD360-0500-2-2-140HA05-HP132	30568713
5,10	6	82	44	35	36	SCD360-0510-2-2-140HA05-HP132	30568714
5,20	6	82	44	35	36	SCD360-0520-2-2-140HA05-HP132	30568715
5,30	6	82	44	35	36	SCD360-0530-2-2-140HA05-HP132	30568716
5,40	6	82	44	35	36	SCD360-0540-2-2-140HA05-HP132	30568717
5,50	6	82	44	35	36	SCD360-0550-2-2-140HA05-HP132	30568718
5,55*	6	82	44	35	36	SCD360-0555-2-2-140HA05-HP132	30568719
5,60	6	82	44	35	36	SCD360-0560-2-2-140HA05-HP132	30568720
5,70	6	82	44	35	36	SCD360-0570-2-2-140HA05-HP132	30568721
5,80	6	82	44	35	36	SCD360-0580-2-2-140HA05-HP132	30568722
5,90	6	82	44	35	36	SCD360-0590-2-2-140HA05-HP132	30568723
6,00	6	82	44	35	36	SCD360-0600-2-2-140HA05-HP132	30568724
6,10	8	91	53	43	36	SCD360-0610-2-2-140HA05-HP132	30568725
6,20	8	91	53	43	36	SCD360-0620-2-2-140HA05-HP132	30568726

Fortsetzung auf nächster Seite.

ECU-Drill-Steel | Vollhartmetall-Spiralbohrer SCD360 (5xD), äußere Kühlmittelzufuhr

Baumaße						Schaftform HA	
d ₁ m7	d ₂ h6	l ₁	l ₂	l ₃	l ₄	Spezifikation	Bestell-Nr.
6,30	8	91	53	43	36	SCD360-0630-2-2-140HA05-HP132	30568727
6,40	8	91	53	43	36	SCD360-0640-2-2-140HA05-HP132	30568728
6,50	8	91	53	43	36	SCD360-0650-2-2-140HA05-HP132	30568729
6,60	8	91	53	43	36	SCD360-0660-2-2-140HA05-HP132	30568730
6,70	8	91	53	43	36	SCD360-0670-2-2-140HA05-HP132	30568731
6,80	8	91	53	43	36	SCD360-0680-2-2-140HA05-HP132	30568732
6,90	8	91	53	43	36	SCD360-0690-2-2-140HA05-HP132	30568733
7,00	8	91	53	43	36	SCD360-0700-2-2-140HA05-HP132	30568734
7,10	8	91	53	43	36	SCD360-0710-2-2-140HA05-HP132	30568735
7,20	8	91	53	43	36	SCD360-0720-2-2-140HA05-HP132	30568736
7,30	8	91	53	43	36	SCD360-0730-2-2-140HA05-HP132	30568737
7,40	8	91	53	43	36	SCD360-0740-2-2-140HA05-HP132	30568738
7,50	8	91	53	43	36	SCD360-0750-2-2-140HA05-HP132	30568740
7,60	8	91	53	43	36	SCD360-0760-2-2-140HA05-HP132	30568741
7,70	8	91	53	43	36	SCD360-0770-2-2-140HA05-HP132	30568742
7,80	8	91	53	43	36	SCD360-0780-2-2-140HA05-HP132	30568743
7,90	8	91	53	43	36	SCD360-0790-2-2-140HA05-HP132	30568744
8,00	8	91	53	43	36	SCD360-0800-2-2-140HA05-HP132	30568745
8,10	10	103	61	49	40	SCD360-0810-2-2-140HA05-HP132	30568746
8,20	10	103	61	49	40	SCD360-0820-2-2-140HA05-HP132	30568747
8,30	10	103	61	49	40	SCD360-0830-2-2-140HA05-HP132	30568748
8,40	10	103	61	49	40	SCD360-0840-2-2-140HA05-HP132	30568749
8,50	10	103	61	49	40	SCD360-0850-2-2-140HA05-HP132	30568750
8,60	10	103	61	49	40	SCD360-0860-2-2-140HA05-HP132	30568751
8,70	10	103	61	49	40	SCD360-0870-2-2-140HA05-HP132	30568752
8,80	10	103	61	49	40	SCD360-0880-2-2-140HA05-HP132	30568753
8,90	10	103	61	49	40	SCD360-0890-2-2-140HA05-HP132	30568754
9,00	10	103	61	49	40	SCD360-0900-2-2-140HA05-HP132	30568755
9,10	10	103	61	49	40	SCD360-0910-2-2-140HA05-HP132	30568756
9,20	10	103	61	49	40	SCD360-0920-2-2-140HA05-HP132	30568757
9,30*	10	103	61	49	40	SCD360-0930-2-2-140HA05-HP132	30568758
9,40	10	103	61	49	40	SCD360-0940-2-2-140HA05-HP132	30568759
9,50	10	103	61	49	40	SCD360-0950-2-2-140HA05-HP132	30568760
9,60	10	103	61	49	40	SCD360-0960-2-2-140HA05-HP132	30568761
9,70	10	103	61	49	40	SCD360-0970-2-2-140HA05-HP132	30568762
9,80	10	103	61	49	40	SCD360-0980-2-2-140HA05-HP132	30568763
9,90	10	103	61	49	40	SCD360-0990-2-2-140HA05-HP132	30568764
10,00	10	103	61	49	40	SCD360-1000-2-2-140HA05-HP132	30568765
10,10	12	118	71	56	45	SCD360-1010-2-2-140HA05-HP132	30568766
10,20	12	118	71	56	45	SCD360-1020-2-2-140HA05-HP132	30568767
10,30	12	118	71	56	45	SCD360-1030-2-2-140HA05-HP132	30568768
10,40	12	118	71	56	45	SCD360-1040-2-2-140HA05-HP132	30568769
10,50	12	118	71	56	45	SCD360-1050-2-2-140HA05-HP132	30568770
10,60	12	118	71	56	45	SCD360-1060-2-2-140HA05-HP132	30568771
10,80	12	118	71	56	45	SCD360-1080-2-2-140HA05-HP132	30568773
11,00	12	118	71	56	45	SCD360-1100-2-2-140HA05-HP132	30568775
11,10	12	118	71	56	45	SCD360-1110-2-2-140HA05-HP132	30568776
11,20*	12	118	71	56	45	SCD360-1120-2-2-140HA05-HP132	30568777
11,30	12	118	71	56	45	SCD360-1130-2-2-140HA05-HP132	30568778
11,40	12	118	71	56	45	SCD360-1140-2-2-140HA05-HP132	30568779
11,50	12	118	71	56	45	SCD360-1150-2-2-140HA05-HP132	30568780
11,60	12	118	71	56	45	SCD360-1160-2-2-140HA05-HP132	30568781
11,70	12	118	71	56	45	SCD360-1170-2-2-140HA05-HP132	30568782
11,80	12	118	71	56	45	SCD360-1180-2-2-140HA05-HP132	30568783
11,90	12	118	71	56	45	SCD360-1190-2-2-140HA05-HP132	30568784
12,00	12	118	71	56	45	SCD360-1200-2-2-140HA05-HP132	30568785
12,20	14	124	77	60	45	SCD360-1220-2-2-140HA05-HP132	30568786

ECU-Drill-Steel | Vollhartmetall-Spiralbohrer SCD360 (5xD), äußere Kühlmittelzufuhr

Baumaße						Schaftform HA	
d ₁ m7	d ₂ h6	l ₁	l ₂	l ₃	l ₄	Spezifikation	Bestell-Nr.
12,50	14	124	77	60	45	SCD360-1250-2-2-140HA05-HP132	30568787
12,70	14	124	77	60	45	SCD360-1270-2-2-140HA05-HP132	30568788
12,80	14	124	77	60	45	SCD360-1280-2-2-140HA05-HP132	30568789
13,00	14	124	77	60	45	SCD360-1300-2-2-140HA05-HP132	30568790
13,10	14	124	77	60	45	SCD360-1310-2-2-140HA05-HP132	30569190
13,50	14	124	77	60	45	SCD360-1350-2-2-140HA05-HP132	30568792
13,70	14	124	77	60	45	SCD360-1370-2-2-140HA05-HP132	30568793
13,80	14	124	77	60	45	SCD360-1380-2-2-140HA05-HP132	30568794
14,00	14	124	77	60	45	SCD360-1400-2-2-140HA05-HP132	30568795
14,20	16	133	83	63	48	SCD360-1420-2-2-140HA05-HP132	30568796
14,50	16	133	83	63	48	SCD360-1450-2-2-140HA05-HP132	30568797
14,70	16	133	83	63	48	SCD360-1470-2-2-140HA05-HP132	30568798
14,80	16	133	83	63	48	SCD360-1480-2-2-140HA05-HP132	30568799
15,00	16	133	83	63	48	SCD360-1500-2-2-140HA05-HP132	30568800
15,50	16	133	83	63	48	SCD360-1550-2-2-140HA05-HP132	30568801
15,70	16	133	83	63	48	SCD360-1570-2-2-140HA05-HP132	30568802
15,80	16	133	83	63	48	SCD360-1580-2-2-140HA05-HP132	30568803
16,00	16	133	83	63	48	SCD360-1600-2-2-140HA05-HP132	30568804
16,50	18	143	93	71	48	SCD360-1650-2-2-140HA05-HP132	30568805
17,00	18	143	93	71	48	SCD360-1700-2-2-140HA05-HP132	30568807
17,50	18	143	93	71	48	SCD360-1750-2-2-140HA05-HP132	30568808
18,00	18	143	93	71	48	SCD360-1800-2-2-140HA05-HP132	30568810
18,50	20	153	101	77	50	SCD360-1850-2-2-140HA05-HP132	30568811
18,80	20	153	101	77	50	SCD360-1880-2-2-140HA05-HP132	30568812
19,00	20	153	101	77	50	SCD360-1900-2-2-140HA05-HP132	30568813
19,80	20	153	101	77	50	SCD360-1980-2-2-140HA05-HP132	30568815
20,00	20	153	101	77	50	SCD360-2000-2-2-140HA05-HP132	30568816

Konfigurierbare Merkmale



Schaftform:
Schaftform: HB | HE

**Spezifikation:**

SCD360-0430-2-2-140[**Schaftform**]05-HP132

Beispiel:

SCD360-0430-2-2-140HE05-HP132

Schaftform HE

Maßangaben in mm.

* Speziell zur Vorfertigung der Kernlöcher für Gewindeformer geeignet.

Schnittwertempfehlung siehe Kapitelende.

Sonderausführungen und andere Beschichtungen auf Anfrage.

ECU-Drill-Steel

Vollhartmetall-Spiralbohrer
SCD361 (8xD), innere Kühlmittelzufuhr

Ausführung:

Bohrerdurchmesser: 3,00 - 20,00 mm
Bohrungstoleranz: \geq IT 9
Schneidstoff: HP132
Schneidenanzahl: 2
Spitzenwinkel: 135°
Spiralwinkel: 30°

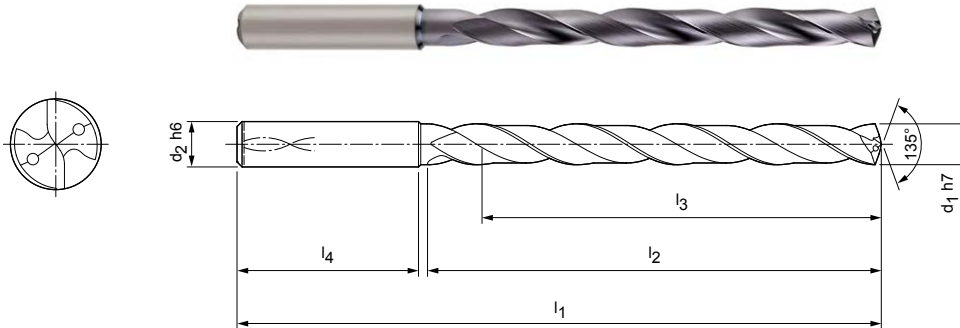

Lagerhaltige Vorzugsbaureihe in Schaftform HA

Baumaße						Schaftform HA	
d ₁ h7	d ₂ h6	l ₁	l ₂	l ₃	l ₄	Spezifikation	Bestell-Nr.
3,00	6	72	34	29	36	SCD361-0300-2-2-135HA08-HP132	30677713
3,10	6	72	34	29	36	SCD361-0310-2-2-135HA08-HP132	30677714
3,20	6	72	34	29	36	SCD361-0320-2-2-135HA08-HP132	30677715
3,30	6	72	34	29	36	SCD361-0330-2-2-135HA08-HP132	30677716
3,40	6	72	34	29	36	SCD361-0340-2-2-135HA08-HP132	30677717
3,50	6	72	34	29	36	SCD361-0350-2-2-135HA08-HP132	30677718
3,60	6	72	34	29	36	SCD361-0360-2-2-135HA08-HP132	30677719
3,70	6	72	34	29	36	SCD361-0370-2-2-135HA08-HP132	30677720
3,80	6	81	43	36	36	SCD361-0380-2-2-135HA08-HP132	30677721
3,90	6	81	43	36	36	SCD361-0390-2-2-135HA08-HP132	30677722
4,00	6	81	43	36	36	SCD361-0400-2-2-135HA08-HP132	30677723
4,10	6	81	43	36	36	SCD361-0410-2-2-135HA08-HP132	30677724
4,20	6	81	43	36	36	SCD361-0420-2-2-135HA08-HP132	30677725
4,30	6	81	43	36	36	SCD361-0430-2-2-135HA08-HP132	30677726
4,40	6	81	43	36	36	SCD361-0440-2-2-135HA08-HP132	30677727
4,50	6	81	43	36	36	SCD361-0450-2-2-135HA08-HP132	30677728
4,60	6	81	43	36	36	SCD361-0460-2-2-135HA08-HP132	30677729
4,70	6	81	43	36	36	SCD361-0470-2-2-135HA08-HP132	30677730
4,80	6	95	57	48	36	SCD361-0480-2-2-135HA08-HP132	30677731
4,90	6	95	57	48	36	SCD361-0490-2-2-135HA08-HP132	30677732
5,00	6	95	57	48	36	SCD361-0500-2-2-135HA08-HP132	30677733
5,10	6	95	57	48	36	SCD361-0510-2-2-135HA08-HP132	30677734
5,20	6	95	57	48	36	SCD361-0520-2-2-135HA08-HP132	30677735
5,30	6	95	57	48	36	SCD361-0530-2-2-135HA08-HP132	30677736
5,50	6	95	57	48	36	SCD361-0550-2-2-135HA08-HP132	30677738
5,70	6	95	57	48	36	SCD361-0570-2-2-135HA08-HP132	30677740
5,80	6	95	57	48	36	SCD361-0580-2-2-135HA08-HP132	30677741
5,90	6	95	57	48	36	SCD361-0590-2-2-135HA08-HP132	30677742
6,00	6	95	57	48	36	SCD361-0600-2-2-135HA08-HP132	30677743
6,10	8	114	76	64	36	SCD361-0610-2-2-135HA08-HP132	30677744
6,20	8	114	76	64	36	SCD361-0620-2-2-135HA08-HP132	30677745
6,30	8	114	76	64	36	SCD361-0630-2-2-135HA08-HP132	30677746
6,50	8	114	76	64	36	SCD361-0650-2-2-135HA08-HP132	30677748
6,60	8	114	76	64	36	SCD361-0660-2-2-135HA08-HP132	30677749
6,70	8	114	76	64	36	SCD361-0670-2-2-135HA08-HP132	30677751

ECU-Drill-Steel | Vollhartmetall-Spiralbohrer SCD361 (8xD), innere Kühlmittelzufuhr

Baumaße						Schaftform HA	
d ₁ h7	d ₂ h6	l ₁	l ₂	l ₃	l ₄	Spezifikation	Bestell-Nr.
6,80	8	114	76	64	36	SCD361-0680-2-2-135HA08-HP132	30677752
6,90	8	114	76	64	36	SCD361-0690-2-2-135HA08-HP132	30677753
7,00	8	114	76	64	36	SCD361-0700-2-2-135HA08-HP132	30677754
7,10	8	114	76	64	36	SCD361-0710-2-2-135HA08-HP132	30677755
7,40	8	114	76	64	36	SCD361-0740-2-2-135HA08-HP132	30677758
7,50	8	114	76	64	36	SCD361-0750-2-2-135HA08-HP132	30677759
7,70	8	114	76	64	36	SCD361-0770-2-2-135HA08-HP132	30677761
7,80	8	114	76	64	36	SCD361-0780-2-2-135HA08-HP132	30677762
7,90	8	114	76	64	36	SCD361-0790-2-2-135HA08-HP132	30677763
8,00	8	114	76	64	36	SCD361-0800-2-2-135HA08-HP132	30677764
8,10	10	142	95	80	40	SCD361-0810-2-2-135HA08-HP132	30677765
8,20	10	142	95	80	40	SCD361-0820-2-2-135HA08-HP132	30677766
8,30	10	142	95	80	40	SCD361-0830-2-2-135HA08-HP132	30677767
8,50	10	142	95	80	40	SCD361-0850-2-2-135HA08-HP132	30677769
8,60	10	142	95	80	40	SCD361-0860-2-2-135HA08-HP132	30677770
8,70	10	142	95	80	40	SCD361-0870-2-2-135HA08-HP132	30677772
8,80	10	142	95	80	40	SCD361-0880-2-2-135HA08-HP132	30677773
9,00	10	142	95	80	40	SCD361-0900-2-2-135HA08-HP132	30677775
9,10	10	142	95	80	40	SCD361-0910-2-2-135HA08-HP132	30677776
9,20	10	142	95	80	40	SCD361-0920-2-2-135HA08-HP132	30677777
9,30	10	142	95	80	40	SCD361-0930-2-2-135HA08-HP132	30677778
9,40	10	142	95	80	40	SCD431-0940-2-2-135HA08-HP765	30550363
9,50	10	142	95	80	40	SCD361-0950-2-2-135HA08-HP132	30677780
9,70	10	142	95	80	40	SCD361-0970-2-2-135HA08-HP132	30677782
9,80	10	142	95	80	40	SCD361-0980-2-2-135HA08-HP132	30677783
9,90	10	142	95	80	40	SCD361-0990-2-2-135HA08-HP132	30677784
10,00	10	142	95	80	40	SCD361-1000-2-2-135HA08-HP132	30677785
10,20	12	162	114	96	45	SCD361-1020-2-2-135HA08-HP132	30677787
10,30	12	162	114	96	45	SCD361-1030-2-2-135HA08-HP132	30677788
10,50	12	162	114	96	45	SCD361-1050-2-2-135HA08-HP132	30677790
10,80	12	162	114	96	45	SCD361-1080-2-2-135HA08-HP132	30677793
11,00	12	162	114	96	45	SCD361-1100-2-2-135HA08-HP132	30677795
11,20	12	162	114	96	45	SCD361-1120-2-2-135HA08-HP132	30677797
11,50	12	162	114	96	45	SCD361-1150-2-2-135HA08-HP132	30677800
11,70	12	162	114	96	45	SCD361-1170-2-2-135HA08-HP132	30677802
11,80	12	162	114	96	45	SCD361-1180-2-2-135HA08-HP132	30677803
12,00	12	162	114	96	45	SCD361-1200-2-2-135HA08-HP132	30677805
12,20	14	178	133	112	45	SCD361-1220-2-2-135HA08-HP132	30677806
12,50	14	178	133	112	45	SCD361-1250-2-2-135HA08-HP132	30677807
12,80	14	178	133	112	45	SCD361-1280-2-2-135HA08-HP132	30677808
13,00	14	178	133	112	45	SCD361-1300-2-2-135HA08-HP132	30677809
13,50	14	178	133	112	45	SCD361-1350-2-2-135HA08-HP132	30677811
13,80	14	178	133	112	45	SCD361-1380-2-2-135HA08-HP132	30677812
14,00	14	178	133	112	45	SCD361-1400-2-2-135HA08-HP132	30677813
14,50	16	203	152	128	48	SCD361-1450-2-2-135HA08-HP132	30677815
15,00	16	203	152	128	48	SCD361-1500-2-2-135HA08-HP132	30677817
15,50	16	203	152	128	48	SCD361-1550-2-2-135HA08-HP132	30677818
15,80	16	203	152	128	48	SCD361-1580-2-2-135HA08-HP132	30677819
16,00	16	203	152	128	48	SCD361-1600-2-2-135HA08-HP132	30677820
16,50	18	222	171	144	48	SCD361-1650-2-2-135HA08-HP132	30677821
17,00	18	222	171	144	48	SCD361-1700-2-2-135HA08-HP132	30677822
17,50	18	222	171	144	48	SCD361-1750-2-2-135HA08-HP132	30677823
18,00	18	222	171	144	48	SCD361-1800-2-2-135HA08-HP132	30677824
18,50	20	243	190	160	50	SCD361-1850-2-2-135HA08-HP132	30677825
19,00	20	243	190	160	50	SCD361-1900-2-2-135HA08-HP132	30677826
20,00	20	243	190	160	50	SCD361-2000-2-2-135HA08-HP132	30677828

Fortsetzung auf nächster Seite.

ECU-Drill-Steel | Vollhartmetall-Spiralbohrer SCD361 (8xD), innere Kühlmittelzufuhr

Konfigurierbare Merkmale



Schaftform:
Schaftform: HB | HE

**Spezifikation:**SCD361-0430-2-2-140[**Schaftform**]08-HP132**Beispiel:**

SCD361-0430-2-2-140HE08-HP132

Schaftform HE

ECU-Drill-Steel

Vollhartmetall-Spiralbohrer
SCD361 (12xD), innere Kühlmittelzufuhr

Ausführung:

Bohrerdurchmesser: 3,00 - 18,00 mm
Bohrungstoleranz: \geq IT 9
Schneidstoff: HP132
Schneidenanzahl: 2
Spitzenwinkel: 135°
Spiralwinkel: 30°

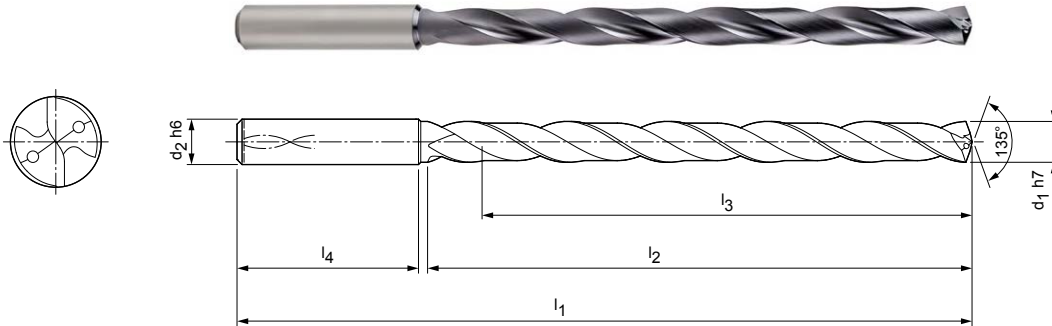

Lagerhaltige Vorzugsbaureihe in Schaftform HA

Baumaße						Schaftform HA	
d ₁ h7	d ₂ h6	l ₁	l ₂	l ₃	l ₄	Spezifikation	Bestell-Nr.
3,00	6	92	54	48	36	SCD361-0300-2-2-135HA12-HP132	30677829
3,10	6	92	54	48	36	SCD361-0310-2-2-135HA12-HP132	30677830
3,20	6	92	54	48	36	SCD361-0320-2-2-135HA12-HP132	30677831
3,30	6	92	54	48	36	SCD361-0330-2-2-135HA12-HP132	30677832
3,40	6	92	54	48	36	SCD361-0340-2-2-135HA12-HP132	30677833
3,50	6	92	54	48	36	SCD361-0350-2-2-135HA12-HP132	30677834
3,60	6	92	54	48	36	SCD361-0360-2-2-135HA12-HP132	30677835
3,70	6	92	54	48	36	SCD361-0370-2-2-135HA12-HP132	30677836
3,80	6	102	64	58	36	SCD361-0380-2-2-135HA12-HP132	30677837
3,90	6	102	64	58	36	SCD361-0390-2-2-135HA12-HP132	30677838
4,00	6	102	64	58	36	SCD361-0400-2-2-135HA12-HP132	30677839
4,10	6	102	64	58	36	SCD361-0410-2-2-135HA12-HP132	30677840
4,20	6	102	64	58	36	SCD361-0420-2-2-135HA12-HP132	30677841
4,30	6	102	64	58	36	SCD361-0430-2-2-135HA12-HP132	30677842
4,40	6	102	64	58	36	SCD361-0440-2-2-135HA12-HP132	30677843
4,50	6	102	64	58	36	SCD361-0450-2-2-135HA12-HP132	30677844
4,60	6	102	64	58	36	SCD361-0460-2-2-135HA12-HP132	30677845
4,70	6	102	64	58	36	SCD361-0470-2-2-135HA12-HP132	30677846
4,80	6	116	78	70	36	SCD361-0480-2-2-135HA12-HP132	30677847
4,90	6	116	78	70	36	SCD361-0490-2-2-135HA12-HP132	30677848
5,00	6	116	78	70	36	SCD361-0500-2-2-135HA12-HP132	30677849
5,10	6	116	78	70	36	SCD361-0510-2-2-135HA12-HP132	30677850
5,20	6	116	78	70	36	SCD361-0520-2-2-135HA12-HP132	30677851
5,50	6	116	78	70	36	SCD361-0550-2-2-135HA12-HP132	30677853
5,80	6	116	78	70	36	SCD361-0580-2-2-135HA12-HP132	30677854
6,00	6	116	78	70	36	SCD361-0600-2-2-135HA12-HP132	30677856
6,30	8	146	108	94	36	SCD361-0630-2-2-135HA12-HP132	30677859
6,50	8	146	108	94	36	SCD361-0650-2-2-135HA12-HP132	30677860
6,60	8	146	108	94	36	SCD361-0660-2-2-135HA12-HP132	30677861
6,80	8	146	108	94	36	SCD361-0680-2-2-135HA12-HP132	30677862
7,00	8	146	108	94	36	SCD361-0700-2-2-135HA12-HP132	30677863
7,40	8	146	108	94	36	SCD361-0740-2-2-135HA12-HP132	30677864
7,50	8	146	108	94	36	SCD361-0750-2-2-135HA12-HP132	30677865
7,80	8	146	108	94	36	SCD361-0780-2-2-135HA12-HP132	30677867
8,00	8	146	108	94	36	SCD361-0800-2-2-135HA12-HP132	30677869

Fortsetzung auf nächster Seite.

ECU-Drill-Steel | Vollhartmetall-Spiralbohrer SCD361 (12xD), innere Kühlmittelzufuhr

Baumaße						Schaftform HA	
d ₁ h7	d ₂ h6	l ₁	l ₂	l ₃	l ₄	Spezifikation	Bestell-Nr.
8,10	10	162	120	110	40	SCD361-0810-2-2-135HA12-HP132	30677870
8,20	10	162	120	110	40	SCD361-0820-2-2-135HA12-HP132	30677871
8,50	10	162	120	110	40	SCD361-0850-2-2-135HA12-HP132	30677874
9,00	10	162	120	110	40	SCD361-0900-2-2-135HA12-HP132	30677878
9,30	10	162	120	110	40	SCD361-0930-2-2-135HA12-HP132	30677881
9,50	10	162	120	110	40	SCD361-0950-2-2-135HA12-HP132	30677883
9,80	10	162	120	110	40	SCD361-0980-2-2-135HA12-HP132	30677885
10,00	10	162	120	110	40	SCD361-1000-2-2-135HA12-HP132	30677887
10,20	12	204	156	142	45	SCD361-1020-2-2-135HA12-HP132	30677888
10,50	12	204	156	142	45	SCD361-1050-2-2-135HA12-HP132	30677889
11,00	12	204	156	142	45	SCD361-1100-2-2-135HA12-HP132	30677891
11,50	12	204	156	142	45	SCD361-1150-2-2-135HA12-HP132	30677893
11,80	12	204	156	142	45	SCD361-1180-2-2-135HA12-HP132	30677894
12,00	12	204	156	142	45	SCD361-1200-2-2-135HA12-HP132	30677895
12,50	14	230	182	166	45	SCD361-1250-2-2-135HA12-HP132	30677896
13,00	14	230	182	166	45	SCD361-1300-2-2-135HA12-HP132	30677897
13,50	14	230	182	166	45	SCD361-1350-2-2-135HA12-HP132	30677899
14,00	14	230	182	166	45	SCD361-1400-2-2-135HA12-HP132	30677900
15,00	16	260	208	192	48	SCD361-1500-2-2-135HA12-HP132	30677903
16,00	16	260	208	192	48	SCD361-1600-2-2-135HA12-HP132	30677906
17,00	18	285	234	216	48	SCD361-1700-2-2-135HA12-HP132	30677908
17,50	18	285	234	216	48	SCD361-1750-2-2-135HA12-HP132	30677909
18,00	18	285	234	216	48	SCD361-1800-2-2-135HA12-HP132	30677910

Konfigurierbare Merkmale



Schaftform:
Schaftform: HB | HE



Spezifikation:
SCD361-0430-2-2-140[Schaftform]12-HP132

Beispiel:
SCD361-0430-2-2-140HE12-HP132

Schaftform HE

Maßangaben in mm.

Schnittwertempfehlung siehe Kapitelende.

Sonderausführungen und andere Beschichtungen auf Anfrage.

MEGA-Drill-Inox

Vollhartmetall-Spiralbohrer
SCD120 (3xD), äußere Kühlmittelzufuhr

Ausführung:

Bohrerdurchmesser: 2,00 – 20,00 mm
Bohrungstoleranz: \geq IT 9
Schneidstoff: HP835
Schneidenanzahl: 2
Anzahl Führungsfasen: 2
Spitzenwinkel: 140°
Spiralwinkel: 30°

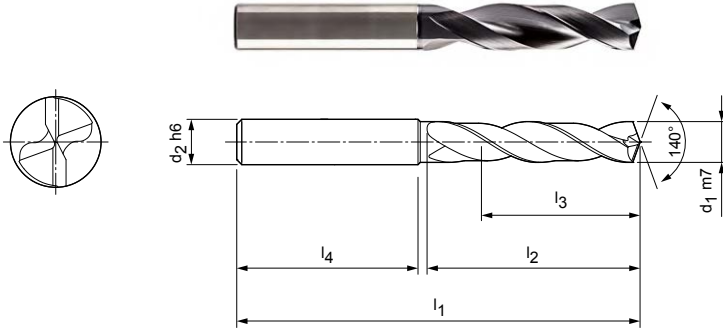

Lagerhaltige Vorzugsbaureihe in Schaftform HA

Baumaße						Schaftform HA	
d ₁ m7	d ₂ h6	l ₁	l ₂	l ₃	l ₄	Spezifikation	Bestell-Nr.
2,00	6	58	16	11	36	SCD120-0200-2-2-140HA03-HP835	30444703
2,10	6	58	16	11	36	SCD120-0210-2-2-140HA03-HP835	30453589
2,20	6	58	16	11	36	SCD120-0220-2-2-140HA03-HP835	30453826
2,30	6	58	16	11	36	SCD120-0230-2-2-140HA03-HP835	30453515
2,33	6	58	16	11	36	SCD120-0233-2-2-140HA03-HP835	30453605
2,40	6	58	16	11	36	SCD120-0240-2-2-140HA03-HP835	30444776
2,43	6	58	16	11	36	SCD120-0243-2-2-140HA03-HP835	30453606
2,50	6	58	16	11	36	SCD120-0250-2-2-140HA03-HP835	30451313
2,55	6	62	22	14	36	SCD120-0255-2-2-140HA03-HP835	30453607
2,60	6	58	16	11	36	SCD120-0260-2-2-140HA03-HP835	30453541
2,62	6	58	16	11	36	SCD120-0262-2-2-140HA03-HP835	30453608
2,70	6	58	16	11	36	SCD120-0270-2-2-140HA03-HP835	30453525
2,80	6	58	16	11	36	SCD120-0280-2-2-140HA03-HP835	30453502
2,90	6	58	16	11	36	SCD120-0290-2-2-140HA03-HP835	30453546
3,00	6	62	22	14	36	SCD120-0300-2-2-140HA03-HP835	30390310
3,10	6	62	22	14	36	SCD120-0310-2-2-140HA03-HP835	30390311
3,15	6	62	22	14	36	SCD120-0315-2-2-140HA03-HP835	30453609
3,20	6	62	22	14	36	SCD120-0320-2-2-140HA03-HP835	30390312
3,22	6	62	22	14	36	SCD120-0322-2-2-140HA03-HP835	30453610
3,25	6	62	22	14	36	SCD120-0325-2-2-140HA03-HP835	30453611
3,30	6	62	22	14	36	SCD120-0330-2-2-140HA03-HP835	30390313
3,40	6	62	22	14	36	SCD120-0340-2-2-140HA03-HP835	30390314
3,50	6	62	22	14	36	SCD120-0350-2-2-140HA03-HP835	30390315
3,60	6	62	22	14	36	SCD120-0360-2-2-140HA03-HP835	30390316
3,70	6	62	22	14	36	SCD120-0370-2-2-140HA03-HP835	30390317
3,80	6	66	26	17	36	SCD120-0380-2-2-140HA03-HP835	30390318
3,90	6	66	26	17	36	SCD120-0390-2-2-140HA03-HP835	30390319
4,00	6	66	26	17	36	SCD120-0400-2-2-140HA03-HP835	30390320
4,05	6	66	26	17	36	SCD120-0405-2-2-140HA03-HP835	30445425
4,10	6	66	26	17	36	SCD120-0410-2-2-140HA03-HP835	30390321
4,20	6	66	26	17	36	SCD120-0420-2-2-140HA03-HP835	30390322
4,30	6	66	26	17	36	SCD120-0430-2-2-140HA03-HP835	30390323
4,35	6	66	26	17	36	SCD120-0435-2-2-140HA03-HP835	30453613
4,40	6	66	26	17	36	SCD120-0440-2-2-140HA03-HP835	30390324
4,50	6	66	26	17	36	SCD120-0450-2-2-140HA03-HP835	30390325

Fortsetzung auf nächster Seite.

MEGA-Drill-Inox | Vollhartmetall-Spiralbohrer SCD120 (3xD), äußere Kühlmittelzufuhr

Baumaße						Schaftform HA	
d ₁ m7	d ₂ h6	l ₁	l ₂	l ₃	l ₄	Spezifikation	Bestell-Nr.
4,60	6	66	26	17	36	SCD120-0460-2-2-140HA03-HP835	30390326
4,65	6	66	26	17	36	SCD120-0465-2-2-140HA03-HP835	30452080
4,70	6	66	26	17	36	SCD120-0470-2-2-140HA03-HP835	30390327
4,80	6	66	30	20	36	SCD120-0480-2-2-140HA03-HP835	30390328
4,90	6	66	30	20	36	SCD120-0490-2-2-140HA03-HP835	30390329
5,00	6	66	30	20	36	SCD120-0500-2-2-140HA03-HP835	30390330
5,03	6	66	30	20	36	SCD120-0503-2-2-140HA03-HP835	30453912
5,10	6	66	30	20	36	SCD120-0510-2-2-140HA03-HP835	30390331
5,20	6	66	30	20	36	SCD120-0520-2-2-140HA03-HP835	30390332
5,30	6	66	30	20	36	SCD120-0530-2-2-140HA03-HP835	30390333
5,40	6	66	30	20	36	SCD120-0540-2-2-140HA03-HP835	30390334
5,50	6	66	30	20	36	SCD120-0550-2-2-140HA03-HP835	30390335
5,55	6	66	30	20	36	SCD120-0555-2-2-140HA03-HP835	30452081
5,60	6	66	30	20	36	SCD120-0560-2-2-140HA03-HP835	30390336
5,70	6	66	30	20	36	SCD120-0570-2-2-140HA03-HP835	30390337
5,80	6	66	30	20	36	SCD120-0580-2-2-140HA03-HP835	30390338
5,90	6	66	30	20	36	SCD120-0590-2-2-140HA03-HP835	30390339
6,00	6	66	30	20	36	SCD120-0600-2-2-140HA03-HP835	30390340
6,10	8	79	38	24	36	SCD120-0610-2-2-140HA03-HP835	30390341
6,20	8	79	38	24	36	SCD120-0620-2-2-140HA03-HP835	30390342
6,30	8	79	38	24	36	SCD120-0630-2-2-140HA03-HP835	30390343
6,40	8	79	38	24	36	SCD120-0640-2-2-140HA03-HP835	30390344
6,50	8	79	38	24	36	SCD120-0650-2-2-140HA03-HP835	30390345
6,60	8	79	38	24	36	SCD120-0660-2-2-140HA03-HP835	30390346
6,70	8	79	38	24	36	SCD120-0670-2-2-140HA03-HP835	30390347
6,80	8	79	38	24	36	SCD120-0680-2-2-140HA03-HP835	30390348
6,90	8	79	38	24	36	SCD120-0690-2-2-140HA03-HP835	30390349
7,00	8	79	38	24	36	SCD120-0700-2-2-140HA03-HP835	30390350
7,20	8	79	42	29	36	SCD120-0720-2-2-140HA03-HP835	30390352
7,40	8	79	42	29	36	SCD120-0740-2-2-140HA03-HP835	30390354
7,45	8	79	42	29	36	SCD120-0745-2-2-140HA03-HP835	30453616
7,50	8	79	42	29	36	SCD120-0750-2-2-140HA03-HP835	30390355
7,70	8	79	42	29	36	SCD120-0770-2-2-140HA03-HP835	30390357
7,80	8	79	42	29	36	SCD120-0780-2-2-140HA03-HP835	30390358
7,90	8	79	42	29	36	SCD120-0790-2-2-140HA03-HP835	30390359
8,00	8	79	42	29	36	SCD120-0800-2-2-140HA03-HP835	30390360
8,10	10	89	49	35	40	SCD120-0810-2-2-140HA03-HP835	30390361
8,20	10	89	49	35	40	SCD120-0820-2-2-140HA03-HP835	30390362
8,30	10	89	49	35	40	SCD120-0830-2-2-140HA03-HP835	30390363
8,40	10	89	49	35	40	SCD120-0840-2-2-140HA03-HP835	30390364
8,50	10	89	49	35	40	SCD120-0850-2-2-140HA03-HP835	30390365
8,60	10	89	49	35	40	SCD120-0860-2-2-140HA03-HP835	30390366
8,70	10	89	49	35	40	SCD120-0870-2-2-140HA03-HP835	30390367
8,80	10	89	49	35	40	SCD120-0880-2-2-140HA03-HP835	30390368
8,90	10	89	49	35	40	SCD120-0890-2-2-140HA03-HP835	30390369
9,00	10	89	49	35	40	SCD120-0900-2-2-140HA03-HP835	30390370
9,10	10	89	49	35	40	SCD120-0910-2-2-140HA03-HP835	30390371
9,50	10	89	49	35	40	SCD120-0950-2-2-140HA03-HP835	30390375
9,80	10	89	49	35	40	SCD120-0980-2-2-140HA03-HP835	30390378
9,90	10	89	49	35	40	SCD120-0990-2-2-140HA03-HP835	30390379
10,00	10	89	49	35	40	SCD120-1000-2-2-140HA03-HP835	30390380
10,10	12	102	56	40	45	SCD120-1010-2-2-140HA03-HP835	30390381
10,20	12	102	56	40	45	SCD120-1020-2-2-140HA03-HP835	30390382
10,30	12	102	56	40	45	SCD120-1030-2-2-140HA03-HP835	30390383
10,50	12	102	56	40	45	SCD120-1050-2-2-140HA03-HP835	30390385
11,00	12	102	56	40	45	SCD120-1100-2-2-140HA03-HP835	30390390
11,50	12	102	56	40	45	SCD120-1150-2-2-140HA03-HP835	30390395

MEGA-Drill-Inox | Vollhartmetall-Spiralbohrer SCD120 (3xD), äußere Kühlmittelzufuhr

Baumaße						Schaftform HA	
d ₁ m7	d ₂ h6	l ₁	l ₂	l ₃	l ₄	Spezifikation	Bestell-Nr.
11,80	12	102	56	40	45	SCD120-1180-2-2-140HA03-HP835	30390398
12,00	12	102	56	40	45	SCD120-1200-2-2-140HA03-HP835	30390400
12,15	14	107	61	43	45	SCD120-1215-2-2-140HA03-HP835	30453623
12,50	14	107	61	43	45	SCD120-1250-2-2-140HA03-HP835	30390401
12,80	14	107	61	43	45	SCD120-1280-2-2-140HA03-HP835	30445978
13,00	14	107	61	43	45	SCD120-1300-2-2-140HA03-HP835	30390402
13,80	14	107	61	43	45	SCD120-1380-2-2-140HA03-HP835	30445979
14,00	14	107	61	43	45	SCD120-1400-2-2-140HA03-HP835	30390404
15,00	16	115	65	45	48	SCD120-1500-2-2-140HA03-HP835	30390406
16,00	16	115	65	45	48	SCD120-1600-2-2-140HA03-HP835	30390408
17,00	18	123	73	51	48	SCD120-1700-2-2-140HA03-HP835	30390410
18,00	18	123	73	51	48	SCD120-1800-2-2-140HA03-HP835	30390412
19,00	20	131	79	55	50	SCD120-1900-2-2-140HA03-HP835	30390414

Konfigurierbare Merkmale



Durchmesser:
Durchmesser in Abstufungen
von 0,01 mm frei wählbar



Schaftform:
Schaftform: HB | HE

Spezifikation:

SCD120-[Durchmesser]-2-2-140[Schaftform]03-HP835

Abmessungen konfigurierbare Baureihe

d ₁ min.	d ₁ max.	d ₂ h6	l ₁	l ₂	l ₃	l ₄
3,00	3,70	6	62	22	14	36
3,71	4,70	6	66	26	17	36
4,71	6,00	6	66	30	20	36
6,01	7,00	8	79	38	24	36
7,01	8,00	8	79	42	29	36
8,01	10,00	10	89	49	35	40
10,01	12,00	12	102	56	40	45
12,01	14,00	14	107	61	43	45
14,01	16,00	16	115	65	45	48
16,01	18,00	18	123	73	51	48
18,01	20,00	20	131	79	55	50

Beispiel:

SCD120-0431-2-2-140HE03-HP835

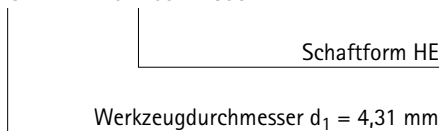

Maßangaben in mm.

Schnittwertempfehlung siehe Kapitelende.

Sonderausführungen und andere Beschichtungen auf Anfrage.

MEGA-Drill-Inox

Vollhartmetall-Spiralbohrer
SCD121 (3xD), innere Kühlmittelzufuhr

Ausführung:
Bohrerdurchmesser: 3,00 – 20,00 mm
Bohrungstoleranz: ≥ IT 9
Schneidstoff: HP835
Schneidenanzahl: 2
Anzahl Führungsfasen: 2
Spitzenwinkel: 140°
Spiralwinkel: 30°

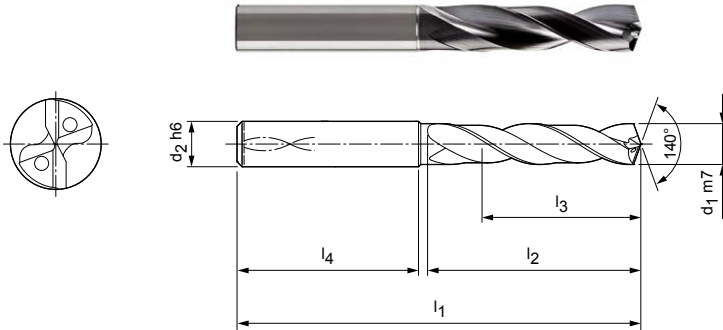

Lagerhaltige Vorzugsbaureihe in Schaftform HA

Baumaße						Schaftform HA	
d ₁ m7	d ₂ h6	l ₁	l ₂	l ₃	l ₄	Spezifikation	Bestell-Nr.
3,00	6	62	22	14	36	SCD121-0300-2-2-140HA03-HP835	30390523
3,05	6	62	22	14	36	SCD121-0305-2-2-140HA03-HP835	30445910
3,15	6	62	22	14	36	SCD121-0315-2-2-140HA03-HP835	30453629
3,20	6	62	22	14	36	SCD121-0320-2-2-140HA03-HP835	30390525
3,25	6	62	22	14	36	SCD121-0325-2-2-140HA03-HP835	30453631
3,30	6	62	22	14	36	SCD121-0330-2-2-140HA03-HP835	30390526
3,40	6	62	22	14	36	SCD121-0340-2-2-140HA03-HP835	30390527
3,50	6	62	22	14	36	SCD121-0350-2-2-140HA03-HP835	30390528
3,60	6	62	22	14	36	SCD121-0360-2-2-140HA03-HP835	30390529
3,70	6	62	22	14	36	SCD121-0370-2-2-140HA03-HP835	30390530
3,80	6	66	26	17	36	SCD121-0380-2-2-140HA03-HP835	30390531
3,90	6	66	26	17	36	SCD121-0390-2-2-140HA03-HP835	30390532
4,00	6	66	26	17	36	SCD121-0400-2-2-140HA03-HP835	30390533
4,10	6	66	26	17	36	SCD121-0410-2-2-140HA03-HP835	30390534
4,20	6	66	26	17	36	SCD121-0420-2-2-140HA03-HP835	30390535
4,30	6	66	26	17	36	SCD121-0430-2-2-140HA03-HP835	30390536
4,35	6	66	26	17	36	SCD121-0435-2-2-140HA03-HP835	30453633
4,40	6	66	26	17	36	SCD121-0440-2-2-140HA03-HP835	30390537
4,50	6	66	26	17	36	SCD121-0450-2-2-140HA03-HP835	30390538
4,65	6	66	26	17	36	SCD121-0465-2-2-140HA03-HP835	30438861
4,70	6	66	26	17	36	SCD121-0470-2-2-140HA03-HP835	30390540
4,80	6	66	30	20	36	SCD121-0480-2-2-140HA03-HP835	30390541
5,00	6	66	30	20	36	SCD121-0500-2-2-140HA03-HP835	30390543
5,10	6	66	30	20	36	SCD121-0510-2-2-140HA03-HP835	30390544
5,20	6	66	30	20	36	SCD121-0520-2-2-140HA03-HP835	30390545
5,30	6	66	30	20	36	SCD121-0530-2-2-140HA03-HP835	30390546
5,40	6	66	30	20	36	SCD121-0540-2-2-140HA03-HP835	30390547
5,50	6	66	30	20	36	SCD121-0550-2-2-140HA03-HP835	30390548
5,55	6	66	30	20	36	SCD121-0555-2-2-140HA03-HP835	30439052
5,60	6	66	30	20	36	SCD121-0560-2-2-140HA03-HP835	30390549
5,70	6	66	30	20	36	SCD121-0570-2-2-140HA03-HP835	30390550
5,80	6	66	30	20	36	SCD121-0580-2-2-140HA03-HP835	30390551
5,90	6	66	30	20	36	SCD121-0590-2-2-140HA03-HP835	30390552
5,95	6	66	30	20	36	SCD121-0595-2-2-140HA03-HP835	30453636
6,00	6	66	30	20	36	SCD121-0600-2-2-140HA03-HP835	30390553

MEGA-Drill-Inox | Vollhartmetall-Spiralbohrer SCD121 (3xD), innere Kühlmittelzufuhr

Baumaße						Schaftform HA	
d ₁ m7	d ₂ h6	l ₁	l ₂	l ₃	l ₄	Spezifikation	Bestell-Nr.
6,10	8	79	38	24	36	SCD121-0610-2-2-140HA03-HP835	30390554
6,20	8	79	38	24	36	SCD121-0620-2-2-140HA03-HP835	30390555
6,30	8	79	38	24	36	SCD121-0630-2-2-140HA03-HP835	30390556
6,40	8	79	38	24	36	SCD121-0640-2-2-140HA03-HP835	30390557
6,50	8	79	38	24	36	SCD121-0650-2-2-140HA03-HP835	30390558
6,60	8	79	38	24	36	SCD121-0660-2-2-140HA03-HP835	30390559
6,70	8	79	38	24	36	SCD121-0670-2-2-140HA03-HP835	30390560
6,80	8	79	38	24	36	SCD121-0680-2-2-140HA03-HP835	30390561
6,90	8	79	38	24	36	SCD121-0690-2-2-140HA03-HP835	30390562
7,00	8	79	38	24	36	SCD121-0700-2-2-140HA03-HP835	30390563
7,10	8	79	42	29	36	SCD121-0710-2-2-140HA03-HP835	30390564
7,20	8	79	42	29	36	SCD121-0720-2-2-140HA03-HP835	30390565
7,30	8	79	42	29	36	SCD121-0730-2-2-140HA03-HP835	30390566
7,40	8	79	42	29	36	SCD121-0740-2-2-140HA03-HP835	30390567
7,45	8	79	42	29	36	SCD121-0745-2-2-140HA03-HP835	30453637
7,50	8	79	42	29	36	SCD121-0750-2-2-140HA03-HP835	30390568
7,70	8	79	42	29	36	SCD121-0770-2-2-140HA03-HP835	30390570
7,80	8	79	42	29	36	SCD121-0780-2-2-140HA03-HP835	30390571
7,90	8	79	42	29	36	SCD121-0790-2-2-140HA03-HP835	30390572
8,00	8	79	42	29	36	SCD121-0800-2-2-140HA03-HP835	30390573
8,10	10	89	49	35	40	SCD121-0810-2-2-140HA03-HP835	30390574
8,20	10	89	49	35	40	SCD121-0820-2-2-140HA03-HP835	30390575
8,30	10	89	49	35	40	SCD121-0830-2-2-140HA03-HP835	30390576
8,40	10	89	49	35	40	SCD121-0840-2-2-140HA03-HP835	30390577
8,50	10	89	49	35	40	SCD121-0850-2-2-140HA03-HP835	30390578
8,60	10	89	49	35	40	SCD121-0860-2-2-140HA03-HP835	30390579
8,70	10	89	49	35	40	SCD121-0870-2-2-140HA03-HP835	30390580
8,80	10	89	49	35	40	SCD121-0880-2-2-140HA03-HP835	30390581
9,00	10	89	49	35	40	SCD121-0900-2-2-140HA03-HP835	30390583
9,10	10	89	49	35	40	SCD121-0910-2-2-140HA03-HP835	30390584
9,20	10	89	49	35	40	SCD121-0920-2-2-140HA03-HP835	30390585
9,30	10	89	49	35	40	SCD121-0930-2-2-140HA03-HP835	30390586
9,35	10	89	49	35	40	SCD121-0935-2-2-140HA03-HP835	30450663
9,40	10	89	49	35	40	SCD121-0940-2-2-140HA03-HP835	30390587
9,50	10	89	49	35	40	SCD121-0950-2-2-140HA03-HP835	30390588
9,70	10	89	49	35	40	SCD121-0970-2-2-140HA03-HP835	30390590
9,80	10	89	49	35	40	SCD121-0980-2-2-140HA03-HP835	30390591
9,90	10	89	49	35	40	SCD121-0990-2-2-140HA03-HP835	30390592
10,00	10	89	49	35	40	SCD121-1000-2-2-140HA03-HP835	30390593
10,20	12	102	56	40	45	SCD121-1020-2-2-140HA03-HP835	30390595
10,30	12	102	56	40	45	SCD121-1030-2-2-140HA03-HP835	30390596
10,40	12	102	56	40	45	SCD121-1040-2-2-140HA03-HP835	30390597
10,50	12	102	56	40	45	SCD121-1050-2-2-140HA03-HP835	30390598
10,70	12	102	56	40	45	SCD121-1070-2-2-140HA03-HP835	30390600
10,80	12	102	56	40	45	SCD121-1080-2-2-140HA03-HP835	30390601
11,00	12	102	56	40	45	SCD121-1100-2-2-140HA03-HP835	30390603
11,10	12	102	56	40	45	SCD121-1110-2-2-140HA03-HP835	30390604
11,30	12	102	56	40	45	SCD121-1130-2-2-140HA03-HP835	30390606
11,50	12	102	56	40	45	SCD121-1150-2-2-140HA03-HP835	30390608
11,70	12	102	56	40	45	SCD121-1170-2-2-140HA03-HP835	30390610
11,80	12	102	56	40	45	SCD121-1180-2-2-140HA03-HP835	30390611
12,00	12	102	56	40	45	SCD121-1200-2-2-140HA03-HP835	30390613
12,15	14	107	61	43	45	SCD121-1215-2-2-140HA03-HP835	30453644
12,50	14	107	61	43	45	SCD121-1250-2-2-140HA03-HP835	30443976
12,80	14	107	61	43	45	SCD121-1280-2-2-140HA03-HP835	30445992
13,00	14	107	61	43	45	SCD121-1300-2-2-140HA03-HP835	30444778
13,50	14	107	61	43	45	SCD121-1350-2-2-140HA03-HP835	30390614

Fortsetzung auf nächster Seite.

MEGA-Drill-Inox | Vollhartmetall-Spiralbohrer SCD121 (3xD), innere Kühlmittelzufuhr

Baumaße						Schaftform HA	
d ₁ m7	d ₂ h6	l ₁	l ₂	l ₃	l ₄	Spezifikation	Bestell-Nr.
13,80	14	107	61	43	45	SCD121-1380-2-2-140HA03-HP835	30445993
14,00	14	107	61	43	45	SCD121-1400-2-2-140HA03-HP835	30445050
14,50	16	115	65	45	48	SCD121-1450-2-2-140HA03-HP835	30390615
15,00	16	115	65	45	48	SCD121-1500-2-2-140HA03-HP835	30390616
15,50	16	115	65	45	48	SCD121-1550-2-2-140HA03-HP835	30442531
15,80	16	115	65	45	48	SCD121-1580-2-2-140HA03-HP835	30445995
16,00	16	115	65	45	48	SCD121-1600-2-2-140HA03-HP835	30390617
17,50	18	123	73	51	48	SCD121-1750-2-2-140HA03-HP835	30390620
18,00	18	123	73	51	48	SCD121-1800-2-2-140HA03-HP835	30390621
20,00	20	131	79	55	50	SCD121-2000-2-2-140HA03-HP835	30390625

Konfigurierbare Merkmale

**Durchmesser:**

Durchmesser in Abstufungen von 0,01 mm frei wählbar

**Schaftform:**

Schaftform: HB | HE

Spezifikation:

SCD121-[Durchmesser]-2-2-140[Schaftform]03-HP835

Beispiel:

SCD121-0431-2-2-140HE03-HP835

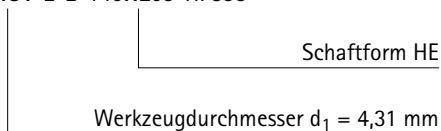

Abmessungen konfigurierbare Baureihe

d ₁ min.	d ₁ max.	d ₂ h6	l ₁	l ₂	l ₃	l ₄
3,71	4,70	6	66	26	17	36
4,71	6,00	6	66	30	20	36
6,01	7,00	8	79	38	24	36
7,01	8,00	8	79	42	29	36
8,01	10,00	10	89	49	35	40
10,01	12,00	12	102	56	40	45
12,01	14,00	14	107	61	43	45
14,01	16,00	16	115	65	45	48
16,01	18,00	18	123	73	51	48
18,01	20,00	20	131	79	55	50
18,01	20,00	20	131	79	55	50

MEGA-Drill-Inox

Vollhartmetall-Spiralbohrer
SCD120 (5xD), äußere Kühlmittelzufuhr

Ausführung:

Bohrerdurchmesser: 3,00 – 20,00 mm
Bohrungstoleranz: \geq IT 9
Schneidstoff: HP835
Schneidenanzahl: 2
Anzahl Führungsfasen: 2
Spitzenwinkel: 140°
Spiralwinkel: 30°

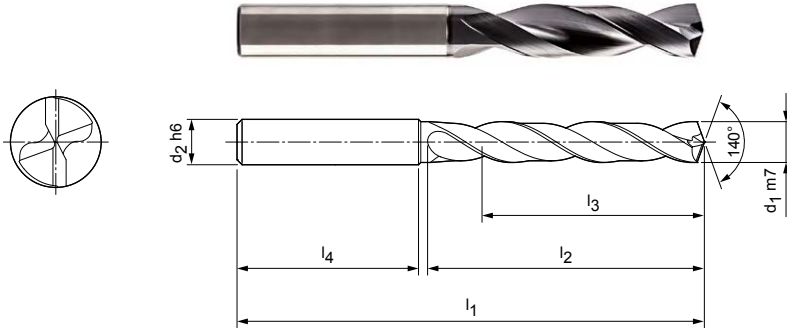

Lagerhaltige Vorzugsbaureihe in Schaftform HA

Baumaße						Schaftform HA	
d_1 m7	d_2 h6	l_1	l_2	l_3	l_4	Spezifikation	Bestell-Nr.
3,00	6	66	28	23	36	SCD120-0300-2-2-140HA05-HP835	30390730
3,10	6	66	28	23	36	SCD120-0310-2-2-140HA05-HP835	30390731
3,20	6	66	28	23	36	SCD120-0320-2-2-140HA05-HP835	30390732
3,30	6	66	28	23	36	SCD120-0330-2-2-140HA05-HP835	30390733
3,40	6	66	28	23	36	SCD120-0340-2-2-140HA05-HP835	30390734
3,50	6	66	28	23	36	SCD120-0350-2-2-140HA05-HP835	30390735
3,60	6	66	28	23	36	SCD120-0360-2-2-140HA05-HP835	30390736
3,70	6	66	28	23	36	SCD120-0370-2-2-140HA05-HP835	30390737
3,80	6	74	36	29	36	SCD120-0380-2-2-140HA05-HP835	30390738
3,90	6	74	36	29	36	SCD120-0390-2-2-140HA05-HP835	30390739
4,00	6	74	36	29	36	SCD120-0400-2-2-140HA05-HP835	30390740
4,10	6	74	36	29	36	SCD120-0410-2-2-140HA05-HP835	30390741
4,20	6	74	36	29	36	SCD120-0420-2-2-140HA05-HP835	30390742
4,30	6	74	36	29	36	SCD120-0430-2-2-140HA05-HP835	30390743
4,40	6	74	36	29	36	SCD120-0440-2-2-140HA05-HP835	30390744
4,50	6	74	36	29	36	SCD120-0450-2-2-140HA05-HP835	30390745
4,60	6	74	36	29	36	SCD120-0460-2-2-140HA05-HP835	30390746
4,70	6	74	36	29	36	SCD120-0470-2-2-140HA05-HP835	30390747
4,80	6	82	44	35	36	SCD120-0480-2-2-140HA05-HP835	30390748
4,90	6	82	44	35	36	SCD120-0490-2-2-140HA05-HP835	30390749
5,00	6	82	44	35	36	SCD120-0500-2-2-140HA05-HP835	30390750
5,10	6	82	44	35	36	SCD120-0510-2-2-140HA05-HP835	30390751
5,20	6	82	44	35	36	SCD120-0520-2-2-140HA05-HP835	30390752
5,30	6	82	44	35	36	SCD120-0530-2-2-140HA05-HP835	30390753
5,40	6	82	44	35	36	SCD120-0540-2-2-140HA05-HP835	30390754
5,50	6	82	44	35	36	SCD120-0550-2-2-140HA05-HP835	30390755
5,60	6	82	44	35	36	SCD120-0560-2-2-140HA05-HP835	30390756
5,80	6	82	44	35	36	SCD120-0580-2-2-140HA05-HP835	30390758
6,00	6	82	44	35	36	SCD120-0600-2-2-140HA05-HP835	30390760
6,10	8	91	53	43	36	SCD120-0610-2-2-140HA05-HP835	30390761
6,20	8	91	53	43	36	SCD120-0620-2-2-140HA05-HP835	30390762
6,30	8	91	53	43	36	SCD120-0630-2-2-140HA05-HP835	30390763
6,40	8	91	53	43	36	SCD120-0640-2-2-140HA05-HP835	30390764
6,50	8	91	53	43	36	SCD120-0650-2-2-140HA05-HP835	30390765
6,60	8	91	53	43	36	SCD120-0660-2-2-140HA05-HP835	30390766

Fortsetzung auf nächster Seite.

MEGA-Drill-Inox | Vollhartmetall-Spiralbohrer SCD120 (5xD), äußere Kühlmittelzufuhr

Baumaße						Schaftform HA	
d ₁ m7	d ₂ h6	l ₁	l ₂	l ₃	l ₄	Spezifikation	Bestell-Nr.
6,70	8	91	53	43	36	SCD120-0670-2-2-140HA05-HP835	30390767
6,80	8	91	53	43	36	SCD120-0680-2-2-140HA05-HP835	30390768
6,90	8	91	53	43	36	SCD120-0690-2-2-140HA05-HP835	30390769
7,00	8	91	53	43	36	SCD120-0700-2-2-140HA05-HP835	30390770
7,10	8	91	53	43	36	SCD120-0710-2-2-140HA05-HP835	30390771
7,40	8	91	53	43	36	SCD120-0740-2-2-140HA05-HP835	30390774
7,50	8	91	53	43	36	SCD120-0750-2-2-140HA05-HP835	30390775
7,60	8	91	53	43	36	SCD120-0760-2-2-140HA05-HP835	30390776
7,80	8	91	53	43	36	SCD120-0780-2-2-140HA05-HP835	30390778
7,90	8	91	53	43	36	SCD120-0790-2-2-140HA05-HP835	30390779
8,00	8	91	53	43	36	SCD120-0800-2-2-140HA05-HP835	30390780
8,10	10	103	61	49	40	SCD120-0810-2-2-140HA05-HP835	30390781
8,20	10	103	61	49	40	SCD120-0820-2-2-140HA05-HP835	30390782
8,50	10	103	61	49	40	SCD120-0850-2-2-140HA05-HP835	30390785
8,60	10	103	61	49	40	SCD120-0860-2-2-140HA05-HP835	30390786
8,70	10	103	61	49	40	SCD120-0870-2-2-140HA05-HP835	30390787
8,80	10	103	61	49	40	SCD120-0880-2-2-140HA05-HP835	30390788
9,00	10	103	61	49	40	SCD120-0900-2-2-140HA05-HP835	30390790
9,20	10	103	61	49	40	SCD120-0920-2-2-140HA05-HP835	30390792
9,30	10	103	61	49	40	SCD120-0930-2-2-140HA05-HP835	30390793
9,40	10	103	61	49	40	SCD120-0940-2-2-140HA05-HP835	30390794
9,50	10	103	61	49	40	SCD120-0950-2-2-140HA05-HP835	30390795
10,00	10	103	61	49	40	SCD120-1000-2-2-140HA05-HP835	30390800
10,20	12	118	71	56	45	SCD120-1020-2-2-140HA05-HP835	30390802
10,30	12	118	71	56	45	SCD120-1030-2-2-140HA05-HP835	30390803
10,50	12	118	71	56	45	SCD120-1050-2-2-140HA05-HP835	30390805
10,80	12	118	71	56	45	SCD120-1080-2-2-140HA05-HP835	30390808
11,00	12	118	71	56	45	SCD120-1100-2-2-140HA05-HP835	30390810
11,70	12	118	71	56	45	SCD120-1170-2-2-140HA05-HP835	30390817
11,80	12	118	71	56	45	SCD120-1180-2-2-140HA05-HP835	30390818
12,00	12	118	71	56	45	SCD120-1200-2-2-140HA05-HP835	30390820
12,50	14	124	77	60	45	SCD120-1250-2-2-140HA05-HP835	30390821
13,00	14	124	77	60	45	SCD120-1300-2-2-140HA05-HP835	30390822
16,00	16	133	83	63	48	SCD120-1600-2-2-140HA05-HP835	30390828
16,50	18	143	93	71	48	SCD120-1650-2-2-140HA05-HP835	30445987

Konfigurierbare Merkmale



Durchmesser:
Durchmesser in Abstufungen
von 0,01 mm frei wählbar



Schaftform:
Schaftform: HB | HE

Spezifikation:

SCD120-[Durchmesser]-2-2-140[Schaftform]05-HP835

Abmessungen konfigurierbare Baureihe

d ₁ min.	d ₁ max.	d ₂ h6	l ₁	l ₂	l ₃	l ₄
3,00	3,70	6	66	66	23	36
3,71	4,70	6	74	74	29	36
4,71	6,00	6	82	44	35	36
6,01	8,00	8	91	53	43	36
8,01	10,00	10	103	61	49	40
10,01	12,00	12	118	71	56	45
12,01	14,00	14	124	77	60	45
14,01	16,00	16	133	83	63	48
16,01	18,00	18	143	93	71	48
18,01	20,00	20	153	101	77	50

Beispiel:

SCD120-0431-2-2-140HE05-HP835

Maßangaben in mm.

Schnittwertempfehlung siehe Kapitelende.

Sonderausführungen und andere Beschichtungen auf Anfrage.

Schaftform HE

Werkzeugdurchmesser d₁ = 4,31 mm

MEGA-Drill-Inox

Vollhartmetall-Spiralbohrer
SCD121 (5xD), innere Kühlmittelzufuhr

Ausführung:

Bohrerdurchmesser: 2,80 – 20,00 mm
Bohrungstoleranz: \geq IT 9
Schneidstoff: HP835
Schneidenanzahl: 2
Anzahl Führungsfasen: 2
Spitzenwinkel: 140°
Spiralwinkel: 30°

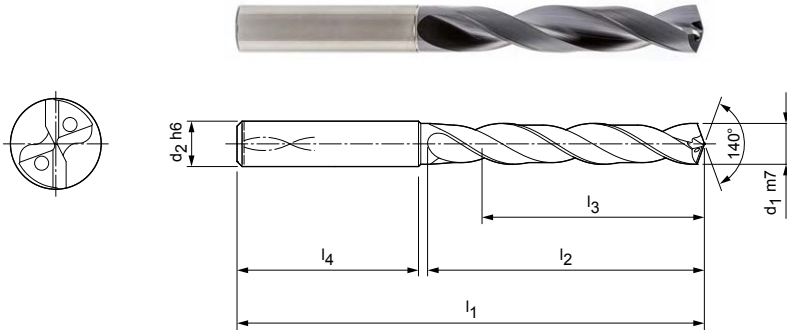

Lagerhaltige Vorzugsbaureihe in Schaftform HA

Baumaße						Schaftform HA	
d ₁ m7	d ₂ h6	l ₁	l ₂	l ₃	l ₄	Spezifikation	Bestell-Nr.
2,80	6	66	28	23	36	SCD121-0280-2-2-140HA05-HP835	30453905
3,00	6	66	28	23	36	SCD121-0300-2-2-140HA05-HP835	30390951
3,10	6	66	28	23	36	SCD121-0310-2-2-140HA05-HP835	30390952
3,15	6	66	28	23	36	SCD121-0315-2-2-140HA05-HP835	30430429
3,20	6	66	28	23	36	SCD121-0320-2-2-140HA05-HP835	30390953
3,22	6	66	28	23	36	SCD121-0322-2-2-140HA05-HP835	30453650
3,25	6	66	28	23	36	SCD121-0325-2-2-140HA05-HP835	30453651
3,30	6	66	28	23	36	SCD121-0330-2-2-140HA05-HP835	30390954
3,40	6	66	28	23	36	SCD121-0340-2-2-140HA05-HP835	30390955
3,50	6	66	28	23	36	SCD121-0350-2-2-140HA05-HP835	30390956
3,60	6	66	28	23	36	SCD121-0360-2-2-140HA05-HP835	30390957
3,70*	6	66	28	23	36	SCD121-0370-2-2-140HA05-HP835	30390958
3,80	6	74	36	29	36	SCD121-0380-2-2-140HA05-HP835	30390959
3,90	6	74	36	29	36	SCD121-0390-2-2-140HA05-HP835	30390960
4,00	6	74	36	29	36	SCD121-0400-2-2-140HA05-HP835	30390961
4,10	6	74	36	29	36	SCD121-0410-2-2-140HA05-HP835	30390962
4,15	6	74	36	29	36	SCD121-0415-2-2-140HA05-HP835	30454007
4,20	6	74	36	29	36	SCD121-0420-2-2-140HA05-HP835	30390963
4,30	6	74	36	29	36	SCD121-0430-2-2-140HA05-HP835	30390964
4,40	6	74	36	29	36	SCD121-0440-2-2-140HA05-HP835	30390965
4,45	6	74	36	29	36	SCD121-0445-2-2-140HA05-HP835	30453654
4,50	6	74	36	29	36	SCD121-0450-2-2-140HA05-HP835	30390966
4,60	6	74	36	29	36	SCD121-0460-2-2-140HA05-HP835	30390967
4,65*	6	74	36	29	36	SCD121-0465-2-2-140HA05-HP835	30453655
4,70	6	74	36	29	36	SCD121-0470-2-2-140HA05-HP835	30390968
4,80	6	82	44	35	36	SCD121-0480-2-2-140HA05-HP835	30390969
4,90	6	82	44	35	36	SCD121-0490-2-2-140HA05-HP835	30390970
5,00	6	82	44	35	36	SCD121-0500-2-2-140HA05-HP835	30390971
5,10	6	82	44	35	36	SCD121-0510-2-2-140HA05-HP835	30390972
5,20	6	82	44	35	36	SCD121-0520-2-2-140HA05-HP835	30390973
5,30	6	82	44	35	36	SCD121-0530-2-2-140HA05-HP835	30390974
5,40	6	82	44	35	36	SCD121-0540-2-2-140HA05-HP835	30390975
5,50	6	82	44	35	36	SCD121-0550-2-2-140HA05-HP835	30390976
5,60	6	82	44	35	36	SCD121-0560-2-2-140HA05-HP835	30390977
5,70	6	82	44	35	36	SCD121-0570-2-2-140HA05-HP835	30390978

Fortsetzung auf nächster Seite.

MEGA-Drill-Inox | Vollhartmetall-Spiralbohrer SCD121 (5xD), innere Kühlmittelzufuhr

Baumaße						Schaftform HA	
d ₁ m7	d ₂ h6	l ₁	l ₂	l ₃	l ₄	Spezifikation	Bestell-Nr.
5,80	6	82	44	35	36	SCD121-0580-2-2-140HA05-HP835	30390979
5,90	6	82	44	35	36	SCD121-0590-2-2-140HA05-HP835	30390980
5,95	6	82	44	35	36	SCD121-0595-2-2-140HA05-HP835	30453657
6,00	6	82	44	35	36	SCD121-0600-2-2-140HA05-HP835	30390981
6,10	8	91	53	43	36	SCD121-0610-2-2-140HA05-HP835	30390982
6,20	8	91	53	43	36	SCD121-0620-2-2-140HA05-HP835	30390983
6,30	8	91	53	43	36	SCD121-0630-2-2-140HA05-HP835	30390984
6,40	8	91	53	43	36	SCD121-0640-2-2-140HA05-HP835	30390985
6,50	8	91	53	43	36	SCD121-0650-2-2-140HA05-HP835	30390986
6,60	8	91	53	43	36	SCD121-0660-2-2-140HA05-HP835	30390987
6,70	8	91	53	43	36	SCD121-0670-2-2-140HA05-HP835	30390988
6,80	8	91	53	43	36	SCD121-0680-2-2-140HA05-HP835	30390989
6,90	8	91	53	43	36	SCD121-0690-2-2-140HA05-HP835	30390990
7,00	8	91	53	43	36	SCD121-0700-2-2-140HA05-HP835	30390991
7,10	8	91	53	43	36	SCD121-0710-2-2-140HA05-HP835	30390992
7,20	8	91	53	43	36	SCD121-0720-2-2-140HA05-HP835	30390993
7,30	8	91	53	43	36	SCD121-0730-2-2-140HA05-HP835	30390994
7,40	8	91	53	43	36	SCD121-0740-2-2-140HA05-HP835	30390995
7,45*	8	91	53	43	36	SCD121-0745-2-2-140HA05-HP835	30453658
7,50	8	91	53	43	36	SCD121-0750-2-2-140HA05-HP835	30390996
7,60	8	91	53	43	36	SCD121-0760-2-2-140HA05-HP835	30390997
7,70	8	91	53	43	36	SCD121-0770-2-2-140HA05-HP835	30390998
7,80	8	91	53	43	36	SCD121-0780-2-2-140HA05-HP835	30390999
8,00	8	91	53	43	36	SCD121-0800-2-2-140HA05-HP835	30391001
8,10	10	103	61	49	40	SCD121-0810-2-2-140HA05-HP835	30391002
8,20	10	103	61	49	40	SCD121-0820-2-2-140HA05-HP835	30391003
8,30	10	103	61	49	40	SCD121-0830-2-2-140HA05-HP835	30391004
8,50	10	103	61	49	40	SCD121-0850-2-2-140HA05-HP835	30391006
8,60	10	103	61	49	40	SCD121-0860-2-2-140HA05-HP835	30391007
8,70	10	103	61	49	40	SCD121-0870-2-2-140HA05-HP835	30391008
8,80	10	103	61	49	40	SCD121-0880-2-2-140HA05-HP835	30391009
8,90	10	103	61	49	40	SCD121-0890-2-2-140HA05-HP835	30391010
9,00	10	103	61	49	40	SCD121-0900-2-2-140HA05-HP835	30391011
9,10	10	103	61	49	40	SCD121-0910-2-2-140HA05-HP835	30391012
9,35	10	103	61	49	40	SCD121-0935-2-2-140HA05-HP835	30450706
9,40	10	103	61	49	40	SCD121-0940-2-2-140HA05-HP835	30391015
9,45	10	103	61	49	40	SCD121-0945-2-2-140HA05-HP835	30453660
9,50	10	103	61	49	40	SCD121-0950-2-2-140HA05-HP835	30391016
9,80	10	103	61	49	40	SCD121-0980-2-2-140HA05-HP835	30391019
9,90	10	103	61	49	40	SCD121-0990-2-2-140HA05-HP835	30391020
10,00	10	103	61	49	40	SCD121-1000-2-2-140HA05-HP835	30391021
10,20	12	118	71	56	45	SCD121-1020-2-2-140HA05-HP835	30391023
10,30	12	118	71	56	45	SCD121-1030-2-2-140HA05-HP835	30391024
10,50	12	118	71	56	45	SCD121-1050-2-2-140HA05-HP835	30391026
10,55	12	118	71	56	45	SCD121-1055-2-2-140HA05-HP835	30453661
10,80	12	118	71	56	45	SCD121-1080-2-2-140HA05-HP835	30391029
11,00	12	118	71	56	45	SCD121-1100-2-2-140HA05-HP835	30391031
11,20*	12	118	71	56	45	SCD121-1120-2-2-140HA05-HP835	30391033
11,25	12	118	71	56	45	SCD121-1125-2-2-140HA05-HP835	30453662
11,30	12	118	71	56	45	SCD121-1130-2-2-140HA05-HP835	30391034
11,50	12	118	71	56	45	SCD121-1150-2-2-140HA05-HP835	30391036
11,70	12	118	71	56	45	SCD121-1170-2-2-140HA05-HP835	30391038
11,80	12	118	71	56	45	SCD121-1180-2-2-140HA05-HP835	30391039
12,00	12	118	71	56	45	SCD121-1200-2-2-140HA05-HP835	30391041
12,50	14	124	77	60	45	SCD121-1250-2-2-140HA05-HP835	30391042
13,00	14	124	77	60	45	SCD121-1300-2-2-140HA05-HP835	30391044
13,50	14	124	77	60	45	SCD121-1350-2-2-140HA05-HP835	30391045

MEGA-Drill-Inox | Vollhartmetall-Spiralbohrer SCD121 (5xD), innere Kühlmittelzufuhr

Baumaße						Schaftform HA	
d ₁ m7	d ₂ h6	l ₁	l ₂	l ₃	l ₄	Spezifikation	Bestell-Nr.
13,80	14	124	77	60	45	SCD121-1380-2-2-140HA05-HP835	30391046
14,00	14	124	77	60	45	SCD121-1400-2-2-140HA05-HP835	30391047
15,00	16	133	83	63	48	SCD121-1500-2-2-140HA05-HP835	30391050
16,00	16	133	83	63	48	SCD121-1600-2-2-140HA05-HP835	30391053
16,50	18	143	93	71	48	SCD121-1650-2-2-140HA05-HP835	30391054
17,00	18	143	93	71	48	SCD121-1700-2-2-140HA05-HP835	30391056
18,00	18	143	93	71	48	SCD121-1800-2-2-140HA05-HP835	30391059
20,00	20	153	101	77	50	SCD121-2000-2-2-140HA05-HP835	30391065

Konfigurierbare Merkmale



Durchmesser:
Durchmesser in Abstufungen
von 0,01 mm frei wählbar



Schaftform:
Schaftform: HB | HE

Spezifikation:

SCD121-[Durchmesser]-2-2-140[Schaftform]05-HP835

Abmessungen konfigurierbare Baureihe

d ₁ min.	d ₁ max.	d ₂ h6	l ₁	l ₂	l ₃	l ₄
3,71	4,70	6	74	36	29	36
4,71	6,00	6	82	44	35	36
6,01	8,00	8	91	53	43	36
8,01	10,00	10	103	61	49	40
10,01	12,00	12	118	71	56	45
12,01	14,00	14	124	77	60	45
14,01	16,00	16	133	83	63	45
16,01	18,00	18	143	93	71	48
18,01	20,00	20	153	101	77	50

Beispiel:

SCD121-0431-2-2-140HE05-HP835

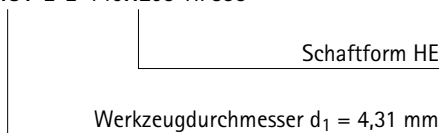

Maßangaben in mm.

* Speziell zur Vorfertigung der Kernlöcher für Gewindeformer geeignet.

Schnittwertempfehlung siehe Kapitelende.

Sonderausführungen und andere Beschichtungen auf Anfrage.

MEGA-Drill-Inox

Vollhartmetall-Spiralbohrer
SCD121 (8xD), innere Kühlmittelzufuhr

Ausführung:

Bohrerdurchmesser: 3,00 – 20,00 mm
Bohrungstoleranz: ≥ IT 9
Schneidstoff: HP835
Schneidenanzahl: 2
Anzahl Führungsfasen: 2
Spitzenwinkel: 140°
Spiralwinkel: 30°

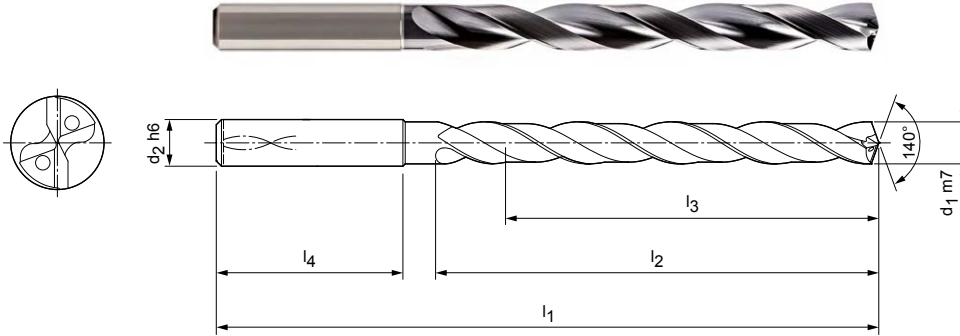

Lagerhaltige Vorzugsbaureihe in Schaftform HA

Baumaße						Schaftform HA	
d ₁ m7	d ₂ h6	l ₁	l ₂	l ₃	l ₄	Spezifikation	Bestell-Nr.
3,00	6	72	34	29	36	SCD121-0300-2-2-140HA08-HP835	30391171
3,20	6	72	34	29	36	SCD121-0320-2-2-140HA08-HP835	30391173
3,30	6	72	34	29	36	SCD121-0330-2-2-140HA08-HP835	30391174
3,40	6	72	34	29	36	SCD121-0340-2-2-140HA08-HP835	30391175
3,50	6	72	34	29	36	SCD121-0350-2-2-140HA08-HP835	30391176
3,70	6	72	34	29	36	SCD121-0370-2-2-140HA08-HP835	30391178
3,80	6	81	43	36	36	SCD121-0380-2-2-140HA08-HP835	30391179
3,90	6	81	43	36	36	SCD121-0390-2-2-140HA08-HP835	30391180
4,00	6	81	43	36	36	SCD121-0400-2-2-140HA08-HP835	30391181
4,20	6	81	43	36	36	SCD121-0420-2-2-140HA08-HP835	30391183
4,30	6	81	43	36	36	SCD121-0430-2-2-140HA08-HP835	30391184
4,40	6	81	43	36	36	SCD121-0440-2-2-140HA08-HP835	30391185
4,50	6	81	43	36	36	SCD121-0450-2-2-140HA08-HP835	30391186
4,80	6	95	57	48	36	SCD121-0480-2-2-140HA08-HP835	30391189
4,90	6	95	57	48	36	SCD121-0490-2-2-140HA08-HP835	30391190
5,00	6	95	57	48	36	SCD121-0500-2-2-140HA08-HP835	30391191
5,10	6	95	57	48	36	SCD121-0510-2-2-140HA08-HP835	30391192
5,30	6	95	57	48	36	SCD121-0530-2-2-140HA08-HP835	30391194
5,50	6	95	57	48	36	SCD121-0550-2-2-140HA08-HP835	30391196
5,60	6	95	57	48	36	SCD121-0560-2-2-140HA08-HP835	30391197
5,80	6	95	57	48	36	SCD121-0580-2-2-140HA08-HP835	30391199
5,90	6	95	57	48	36	SCD121-0590-2-2-140HA08-HP835	30391200
6,00	6	95	57	48	36	SCD121-0600-2-2-140HA08-HP835	30391201
6,10	8	114	76	64	36	SCD121-0610-2-2-140HA08-HP835	30391202
6,50	8	114	76	64	36	SCD121-0650-2-2-140HA08-HP835	30391206
6,60	8	114	76	64	36	SCD121-0660-2-2-140HA08-HP835	30391207
6,70	8	114	76	64	36	SCD121-0670-2-2-140HA08-HP835	30391208
6,80	8	114	76	64	36	SCD121-0680-2-2-140HA08-HP835	30391209
6,90	8	114	76	64	36	SCD121-0690-2-2-140HA08-HP835	30391210
7,00	8	114	76	64	36	SCD121-0700-2-2-140HA08-HP835	30391212
7,20	8	114	76	64	36	SCD121-0720-2-2-140HA08-HP835	30391214
7,50	8	114	76	64	36	SCD121-0750-2-2-140HA08-HP835	30391217
7,60	8	114	76	64	36	SCD121-0760-2-2-140HA08-HP835	30391218
7,80	8	114	76	64	36	SCD121-0780-2-2-140HA08-HP835	30391220
8,00	8	114	76	64	36	SCD121-0800-2-2-140HA08-HP835	30391222

MEGA-Drill-Inox | Vollhartmetall-Spiralbohrer SCD121 (8xD), innere Kühlmittelzufuhr

Baumaße						Schaftform HA	
d ₁ m7	d ₂ h6	l ₁	l ₂	l ₃	l ₄	Spezifikation	Bestell-Nr.
8,50	10	142	95	80	40	SCD121-0850-2-2-140HA08-HP835	30391227
8,90	10	142	95	80	40	SCD121-0890-2-2-140HA08-HP835	30391231
9,00	10	142	95	80	40	SCD121-0900-2-2-140HA08-HP835	30391232
9,10	10	142	95	80	40	SCD121-0910-2-2-140HA08-HP835	30391233
9,30	10	142	95	80	40	SCD121-0930-2-2-140HA08-HP835	30391235
9,50	10	142	95	80	40	SCD121-0950-2-2-140HA08-HP835	30391237
9,60	10	142	95	80	40	SCD121-0960-2-2-140HA08-HP835	30391238
9,70	10	142	95	80	40	SCD121-0970-2-2-140HA08-HP835	30391239
9,80	10	142	95	80	40	SCD121-0980-2-2-140HA08-HP835	30391240
10,00	10	142	95	80	40	SCD121-1000-2-2-140HA08-HP835	30391242
10,10	12	162	114	96	45	SCD121-1010-2-2-140HA08-HP835	30391243
10,20	12	162	114	96	45	SCD121-1020-2-2-140HA08-HP835	30391244
10,80	12	162	114	96	45	SCD121-1080-2-2-140HA08-HP835	30391250
11,00	12	162	114	96	45	SCD121-1100-2-2-140HA08-HP835	30391252
11,50	12	162	114	96	45	SCD121-1150-2-2-140HA08-HP835	30391257
11,80	12	162	114	96	45	SCD121-1180-2-2-140HA08-HP835	30391260
12,00	12	162	114	96	45	SCD121-1200-2-2-140HA08-HP835	30391262
13,00	14	178	133	112	45	SCD121-1300-2-2-140HA08-HP835	30391265
13,50	14	178	133	112	45	SCD121-1350-2-2-140HA08-HP835	30391266
14,00	14	178	133	112	45	SCD121-1400-2-2-140HA08-HP835	30391268
14,50	16	203	152	128	48	SCD121-1450-2-2-140HA08-HP835	30391269
15,00	16	203	152	128	48	SCD121-1500-2-2-140HA08-HP835	30391271
18,00	18	222	171	144	48	SCD121-1800-2-2-140HA08-HP835	30391280

Konfigurierbare Merkmale



Durchmesser:
Durchmesser in Abstufungen
von 0,01 mm frei wählbar



Schaftform:
Schaftform: HB | HE

Spezifikation:

SCD121-[Durchmesser]-2-2-140[Schaftform]08-HP835

Beispiel:

SCD121-0431-2-2-140HE08-HP835

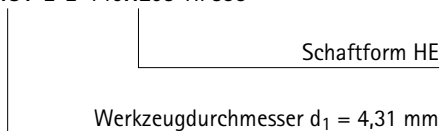

Abmessungen konfigurierbare Baureihe

d ₁ min.	d ₁ max.	d ₂ h6	l ₁	l ₂	l ₃	l ₄
3,71	4,70	6	81	43	36	36
4,71	6,00	6	95	57	48	36
6,01	8,00	8	114	76	64	36
8,01	10,00	10	142	95	80	40
10,01	12,00	12	162	114	96	45
12,01	14,00	14	178	133	112	45
14,01	16,00	16	203	152	128	48
16,01	18,00	18	222	171	144	48
18,01	20,00	20	243	190	160	50
16,01	18,00	18	123	73	51	48
18,01	20,00	20	131	79	55	50

Maßangaben in mm.

Schnittwertempfehlung siehe Kapitelende.

Sonderausführungen und andere Beschichtungen auf Anfrage.

MEGA-Speed-Drill-Inox

Vollhartmetall-Spiralbohrer
SCD411 (5xD) innere Kühlmittelzufuhr

Ausführung:
Bohrerdurchmesser: 3,00 – 20,00 mm
Bohrungstoleranz: \geq IT 9
Schneidstoff: HP374
Schneidenanzahl: 2
Anzahl Führungsfasen: 3
Spitzenwinkel: 135°
Spiralwinkel: 30°

Anwendung:
Für Hochgeschwindigkeitsbearbeitung.

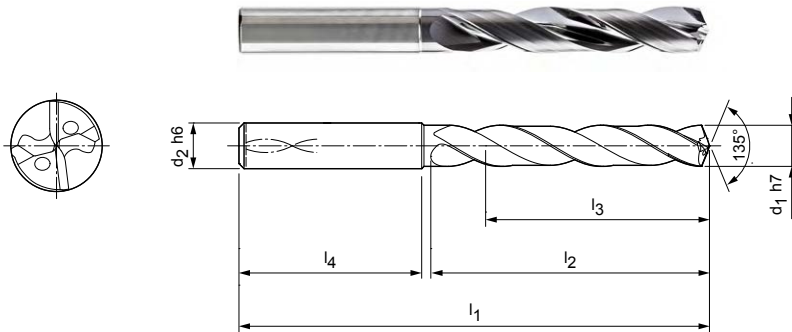

Lagerhaltige Vorzugsbaureihe in Schaftform HA

Baumaße						Schaftform HA	
d ₁ h7	d ₂ h6	l ₁	l ₂	l ₃	l ₄	Spezifikation	Bestell-Nr.
3,00	6	66	28	23	36	SCD411-0300-2-3-135HA05-HP374	30488182
3,10	6	66	28	23	36	SCD411-0310-2-3-135HA05-HP374	30488183
3,20	6	66	28	23	36	SCD411-0320-2-3-135HA05-HP374	30488184
3,30	6	66	28	23	36	SCD411-0330-2-3-135HA05-HP374	30488185
3,40	6	66	28	23	36	SCD411-0340-2-3-135HA05-HP374	30488186
3,50	6	66	28	23	36	SCD411-0350-2-3-135HA05-HP374	30488187
3,70	6	66	28	23	36	SCD411-0370-2-3-135HA05-HP374	30488189
3,80	6	74	36	29	36	SCD411-0380-2-3-135HA05-HP374	30488190
4,00	6	74	36	29	36	SCD411-0400-2-3-135HA05-HP374	30488192
4,10	6	74	36	29	36	SCD411-0410-2-3-135HA05-HP374	30488193
4,20	6	74	36	29	36	SCD411-0420-2-3-135HA05-HP374	30488194
4,30	6	74	36	29	36	SCD411-0430-2-3-135HA05-HP374	30488195
4,50	6	74	36	29	36	SCD411-0450-2-3-135HA05-HP374	30488197
4,65	6	74	36	29	36	SCD411-0465-2-3-135HA05-HP374	30488199
4,70	6	74	36	29	36	SCD411-0470-2-3-135HA05-HP374	30488200
4,80	6	82	44	35	36	SCD411-0480-2-3-135HA05-HP374	30488201
5,00	6	82	44	35	36	SCD411-0500-2-3-135HA05-HP374	30488203
5,10	6	82	44	35	36	SCD411-0510-2-3-135HA05-HP374	30488204
5,20	6	82	44	35	36	SCD411-0520-2-3-135HA05-HP374	30488205
5,30	6	82	44	35	36	SCD411-0530-2-3-135HA05-HP374	30488206
5,50	6	82	44	35	36	SCD411-0550-2-3-135HA05-HP374	30488208
5,55	6	82	44	35	36	SCD411-0555-2-3-135HA05-HP374	30488209
5,60	6	82	44	35	36	SCD411-0560-2-3-135HA05-HP374	30488210
5,80	6	82	44	35	36	SCD411-0580-2-3-135HA05-HP374	30488212
5,90	6	82	44	35	36	SCD411-0590-2-3-135HA05-HP374	30488213
6,00	6	82	44	35	36	SCD411-0600-2-3-135HA05-HP374	30488214
6,10	8	91	53	43	36	SCD411-0610-2-3-135HA05-HP374	30488215
6,30	8	91	53	43	36	SCD411-0630-2-3-135HA05-HP374	30488217
6,50	8	91	53	43	36	SCD411-0650-2-3-135HA05-HP374	30488219
6,60	8	91	53	43	36	SCD411-0660-2-3-135HA05-HP374	30488220
6,80	8	91	53	43	36	SCD411-0680-2-3-135HA05-HP374	30488222
6,90	8	91	53	43	36	SCD411-0690-2-3-135HA05-HP374	30488223
7,00	8	91	53	43	36	SCD411-0700-2-3-135HA05-HP374	30488224
7,30	8	91	53	43	36	SCD411-0730-2-3-135HA05-HP374	30488227
7,40	8	91	53	43	36	SCD411-0740-2-3-135HA05-HP374	30488228

MEGA-Speed-Drill-Inox | Vollhartmetall-Spiralbohrer SCD411 (5xD), innere Kühlmittelzufuhr

Baumaße						Schaftform HA	
d ₁ h7	d ₂ h6	l ₁	l ₂	l ₃	l ₄	Spezifikation	Bestell-Nr.
7,50	8	91	53	43	36	SCD411-0750-2-3-135HA05-HP374	30488229
7,60	8	91	53	43	36	SCD411-0760-2-3-135HA05-HP374	30488230
7,80	8	91	53	43	36	SCD411-0780-2-3-135HA05-HP374	30488232
8,00	8	91	53	43	36	SCD411-0800-2-3-135HA05-HP374	30488234
8,30	10	103	61	49	40	SCD411-0830-2-3-135HA05-HP374	30488237
8,50	10	103	61	49	40	SCD411-0850-2-3-135HA05-HP374	30488239
8,60	10	103	61	49	40	SCD411-0860-2-3-135HA05-HP374	30488240
8,70	10	103	61	49	40	SCD411-0870-2-3-135HA05-HP374	30488241
8,80	10	103	61	49	40	SCD411-0880-2-3-135HA05-HP374	30488242
8,90	10	103	61	49	40	SCD411-0890-2-3-135HA05-HP374	30488243
9,00	10	103	61	49	40	SCD411-0900-2-3-135HA05-HP374	30488244
9,20	10	103	61	49	40	SCD411-0920-2-3-135HA05-HP374	30488246
9,50	10	103	61	49	40	SCD411-0950-2-3-135HA05-HP374	30488249
9,70	10	103	61	49	40	SCD411-0970-2-3-135HA05-HP374	30488251
9,80	10	103	61	49	40	SCD411-0980-2-3-135HA05-HP374	30488252
9,90	10	103	61	49	40	SCD411-0990-2-3-135HA05-HP374	30488253
10,00	10	103	61	49	40	SCD411-1000-2-3-135HA05-HP374	30488254
10,20	12	118	71	56	45	SCD411-1020-2-3-135HA05-HP374	30488256
10,30	12	118	71	56	45	SCD411-1030-2-3-135HA05-HP374	30488257
10,50	12	118	71	56	45	SCD411-1050-2-3-135HA05-HP374	30488259
10,80	12	118	71	56	45	SCD411-1080-2-3-135HA05-HP374	30488262
11,00	12	118	71	56	45	SCD411-1100-2-3-135HA05-HP374	30488264
11,50	12	118	71	56	45	SCD411-1150-2-3-135HA05-HP374	30488269
11,80	12	118	71	56	45	SCD411-1180-2-3-135HA05-HP374	30488272
12,00	12	118	71	56	45	SCD411-1200-2-3-135HA05-HP374	30488274
12,20	14	124	77	60	45	SCD411-1220-2-3-135HA05-HP374	31307527
12,50	14	124	77	60	45	SCD411-1250-2-3-135HA05-HP374	30488275
12,80	14	124	77	60	45	SCD411-1280-2-3-135HA05-HP374	30488276
13,00	14	124	77	60	45	SCD411-1300-2-3-135HA05-HP374	30488277
13,50	14	124	77	60	45	SCD411-1350-2-3-135HA05-HP374	30488278
14,00	14	124	77	60	45	SCD411-1400-2-3-135HA05-HP374	30488280
14,20	16	133	83	63	48	SCD411-1420-2-3-135HA05-HP374	30661538
14,50	16	133	83	71	48	SCD411-1450-2-3-135HA05-HP374	30488281
15,00	16	133	83	71	48	SCD411-1500-2-3-135HA05-HP374	30488283
16,00	16	133	83	71	48	SCD411-1600-2-3-135HA05-HP374	30488286
17,00	18	143	93	71	48	SCD411-1700-2-3-135HA05-HP374	30488289
17,50	18	143	93	71	48	SCD411-1750-2-3-135HA05-HP374	30488290
18,00	18	143	93	71	48	SCD411-1800-2-3-135HA05-HP374	30488292
18,50	20	153	101	77	50	SCD411-1850-2-3-135HA05-HP374	30488293
20,00	20	153	101	77	50	SCD411-2000-2-3-135HA05-HP374	30488298

Fortsetzung auf nächster Seite.

MEGA-Speed-Drill-Inox | Vollhartmetall-Spiralbohrer SCD411 (5xD), innere Kühlmittelzufuhr

Konfigurierbare Merkmale



Durchmesser:
Durchmesser in Abstufungen
von 0,01 mm frei wählbar



Schaftform:
Schaftform: HB | HE

Spezifikation:

SCD411-[Durchmesser]-2-3-135[Schaftform]05-HP374

Abmessungen konfigurierbare Baureihe

d ₁ min.	d ₁ max.	d ₂ h6	l ₁	l ₂	l ₃	l ₄
3,00	3,70	6	66	28	23	36
3,71	4,70	6	74	36	29	36
4,71	6,00	6	82	44	35	36
6,01	8,00	8	91	53	43	36
8,01	10,00	10	103	61	49	40
10,01	12,00	12	118	71	56	45
12,01	14,00	14	124	77	60	45
14,01	16,00	16	133	83	63	48
16,01	18,00	18	143	93	71	48
18,01	20,00	20	153	101	77	50

Beispiel:

SCD411-0431-2-3-140HE05-HP374

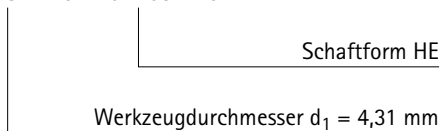

MEGA-Speed-Drill-Inox

Vollhartmetall-Spiralbohrer
SCD411 (8xD), innere Kühlmittelzufuhr

Ausführung:

Bohrerdurchmesser: 3,00 – 20,00 mm
Bohrungstoleranz: \geq IT 9
Schneidstoff: HP374
Schneidenanzahl: 2
Anzahl Führungsfasen: 3
Spitzenwinkel: 135°
Spiralwinkel: 30°

Anwendung:

Für Hochgeschwindigkeitsbearbeitung.

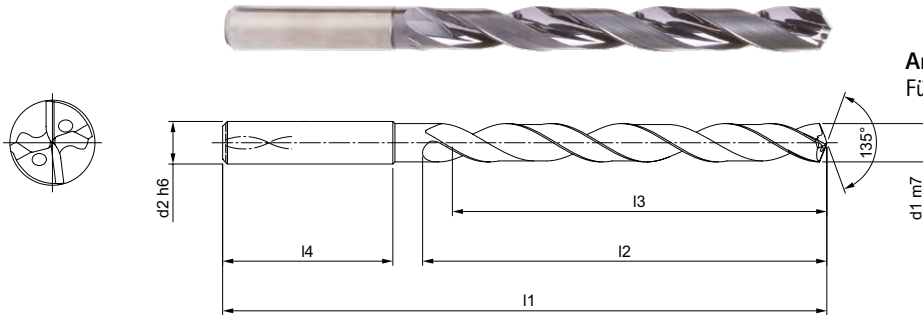

Lagerhaltige Vorzugsbaureihe in Schaftform HA

Baumaße						Schaftform HA	
d ₁ m7	d ₂ h6	l ₁	l ₂	l ₃	l ₄	Spezifikation	Bestell-Nr.
3,00	6	72	34	29	36	SCD411-0300-2-3-135HA08-HP374	31159372
3,20	6	72	34	29	36	SCD411-0320-2-3-135HA08-HP374	31159374
3,30	6	72	34	29	36	SCD411-0330-2-3-135HA08-HP374	31159375
3,40	6	72	34	29	36	SCD411-0340-2-3-135HA08-HP374	31159376
3,50	6	72	34	29	36	SCD411-0350-2-3-135HA08-HP374	31159377
3,70	6	72	34	29	36	SCD411-0370-2-3-135HA08-HP374	31159379
3,90	6	81	43	36	36	SCD411-0390-2-3-135HA08-HP374	31159391
4,00	6	81	43	36	36	SCD411-0400-2-3-135HA08-HP374	31159392
4,10	6	81	43	36	36	SCD411-0410-2-3-135HA08-HP374	31159393
4,20	6	81	43	36	36	SCD411-0420-2-3-135HA08-HP374	31159394
4,30	6	81	43	36	36	SCD411-0430-2-3-135HA08-HP374	31159395
4,50	6	81	43	36	36	SCD411-0450-2-3-135HA08-HP374	31159397
4,60	6	81	43	36	36	SCD411-0460-2-3-135HA08-HP374	31159398
4,80	6	95	57	48	36	SCD411-0480-2-3-135HA08-HP374	31159401
5,00	6	95	57	48	36	SCD411-0500-2-3-135HA08-HP374	31159403
5,10	6	95	57	48	36	SCD411-0510-2-3-135HA08-HP374	31159404
5,20	6	95	57	48	36	SCD411-0520-2-3-135HA08-HP374	31159405
5,40	6	95	57	48	36	SCD411-0540-2-3-135HA08-HP374	31159407
5,50	6	95	57	48	36	SCD411-0550-2-3-135HA08-HP374	31159408
5,80	6	95	57	48	36	SCD411-0580-2-3-135HA08-HP374	31159412
6,00	6	95	57	48	36	SCD411-0600-2-3-135HA08-HP374	31159414
6,10	8	114	76	64	36	SCD411-0610-2-3-135HA08-HP374	31159415
6,50	8	114	76	64	36	SCD411-0650-2-3-135HA08-HP374	31159419
6,80	8	114	76	64	36	SCD411-0680-2-3-135HA08-HP374	31159422
7,00	8	114	76	64	36	SCD411-0700-2-3-135HA08-HP374	31159424
7,50	8	114	76	64	36	SCD411-0750-2-3-135HA08-HP374	31159429
7,80	8	114	76	64	36	SCD411-0780-2-3-135HA08-HP374	31159432
8,00	8	114	76	64	36	SCD411-0800-2-3-135HA08-HP374	31159434
8,50	10	142	95	80	40	SCD411-0850-2-3-135HA08-HP374	31159439
9,00	10	142	95	80	40	SCD411-0900-2-3-135HA08-HP374	31159444
9,30	10	142	95	80	40	SCD411-0930-2-3-135HA08-HP374	31159447
9,50	10	142	95	80	40	SCD411-0950-2-3-135HA08-HP374	31159449
9,80	10	142	95	80	40	SCD411-0980-2-3-135HA08-HP374	31159452
10,00	10	142	95	80	40	SCD411-1000-2-3-135HA08-HP374	31159454
10,20	12	162	114	96	45	SCD411-1020-2-3-135HA08-HP374	31159456

Fortsetzung auf nächster Seite.

MEGA-Speed-Drill-Inox | Vollhartmetall-Spiralbohrer SCD411 (8xD), innere Kühlmittelzufuhr

Baumaße						Schaftform HA	
d ₁ m7	d ₂ h6	l ₁	l ₂	l ₃	l ₄	Spezifikation	Bestell-Nr.
10,50	12	162	114	96	45	SCD411-1050-2-3-135HA08-HP374	31159459
11,00	12	162	114	96	45	SCD411-1100-2-3-135HA08-HP374	31159464
11,80	12	162	114	96	45	SCD411-1180-2-3-135HA08-HP374	31159472
12,00	12	162	114	96	45	SCD411-1200-2-3-135HA08-HP374	31159474
12,50	14	178	133	112	45	SCD411-1250-2-3-135HA08-HP374	31159476
13,00	14	178	133	112	45	SCD411-1300-2-3-135HA08-HP374	31159478
13,50	14	178	133	112	45	SCD411-1350-2-3-135HA08-HP374	31159479
14,00	14	178	133	112	45	SCD411-1400-2-3-135HA08-HP374	31159481
15,00	16	203	152	128	48	SCD411-1500-2-3-135HA08-HP374	31159485
16,00	16	203	152	128	48	SCD411-1600-2-3-135HA08-HP374	31159489
7,30	8	114	76	64	36	SCD411-0730-2-3-135HA08-HP374	31159427
7,40	8	114	76	64	36	SCD411-0740-2-3-135HA08-HP374	31159428
7,50	8	114	76	64	36	SCD411-0750-2-3-135HA08-HP374	31159429
7,60	8	114	76	64	36	SCD411-0760-2-3-135HA08-HP374	31159430
7,70	8	114	76	64	36	SCD411-0770-2-3-135HA08-HP374	31159431
7,80	8	114	76	64	36	SCD411-0780-2-3-135HA08-HP374	31159432
7,90	8	114	76	64	36	SCD411-0790-2-3-135HA08-HP374	31159433
8,00	8	114	76	64	36	SCD411-0800-2-3-135HA08-HP374	31159434
8,10	10	142	95	80	40	SCD411-0810-2-3-135HA08-HP374	31159435
8,20	10	142	95	80	40	SCD411-0820-2-3-135HA08-HP374	31159436
8,30	10	142	95	80	40	SCD411-0830-2-3-135HA08-HP374	31159437
8,40	10	142	95	80	40	SCD411-0840-2-3-135HA08-HP374	31159438
8,50	10	142	95	80	40	SCD411-0850-2-3-135HA08-HP374	31159439
8,60	10	142	95	80	40	SCD411-0860-2-3-135HA08-HP374	31159440
8,70	10	142	95	80	40	SCD411-0870-2-3-135HA08-HP374	31159441
8,80	10	142	95	80	40	SCD411-0880-2-3-135HA08-HP374	31159442
8,90	10	142	95	80	40	SCD411-0890-2-3-135HA08-HP374	31159443
9,00	10	142	95	80	40	SCD411-0900-2-3-135HA08-HP374	31159444
9,10	10	142	95	80	40	SCD411-0910-2-3-135HA08-HP374	31159445
9,20	10	142	95	80	40	SCD411-0920-2-3-135HA08-HP374	31159446
9,30	10	142	95	80	40	SCD411-0930-2-3-135HA08-HP374	31159447
9,40	10	142	95	80	40	SCD411-0940-2-3-135HA08-HP374	31159448
9,50	10	142	95	80	40	SCD411-0950-2-3-135HA08-HP374	31159449
9,60	10	142	95	80	40	SCD411-0960-2-3-135HA08-HP374	31159450
9,70	10	142	95	80	40	SCD411-0970-2-3-135HA08-HP374	31159451
9,80	10	142	95	80	40	SCD411-0980-2-3-135HA08-HP374	31159452
9,90	10	142	95	80	40	SCD411-0990-2-3-135HA08-HP374	31159453
10,00	10	142	95	80	40	SCD411-1000-2-3-135HA08-HP374	31159454
10,10	12	162	114	96	45	SCD411-1010-2-3-135HA08-HP374	31159455
10,20	12	162	114	96	45	SCD411-1020-2-3-135HA08-HP374	31159456
10,30	12	162	114	96	45	SCD411-1030-2-3-135HA08-HP374	31159457
10,40	12	162	114	96	45	SCD411-1040-2-3-135HA08-HP374	31159458
10,50	12	162	114	96	45	SCD411-1050-2-3-135HA08-HP374	31159459
10,60	12	162	114	96	45	SCD411-1060-2-3-135HA08-HP374	31159460
10,70	12	162	114	96	45	SCD411-1070-2-3-135HA08-HP374	31159461
10,80	12	162	114	96	45	SCD411-1080-2-3-135HA08-HP374	31159462
10,90	12	162	114	96	45	SCD411-1090-2-3-135HA08-HP374	31159463
11,00	12	162	114	96	45	SCD411-1100-2-3-135HA08-HP374	31159464
11,10	12	162	114	96	45	SCD411-1110-2-3-135HA08-HP374	31159465
11,20	12	162	114	96	45	SCD411-1120-2-3-135HA08-HP374	31159466
11,30	12	162	114	96	45	SCD411-1130-2-3-135HA08-HP374	31159467
11,40	12	162	114	96	45	SCD411-1140-2-3-135HA08-HP374	31159468
11,50	12	162	114	96	45	SCD411-1150-2-3-135HA08-HP374	31159469
11,60	12	162	114	96	45	SCD411-1160-2-3-135HA08-HP374	31159470
11,70	12	162	114	96	45	SCD411-1170-2-3-135HA08-HP374	31159471
11,80	12	162	114	96	45	SCD411-1180-2-3-135HA08-HP374	31159472
11,90	12	162	114	96	45	SCD411-1190-2-3-135HA08-HP374	31159473

MEGA-Speed-Drill-Inox | Vollhartmetall-Spiralbohrer SCD411 (8xD), innere Kühlmittelzufuhr

Baumaße						Schaftform HA	
d ₁ m7	d ₂ h6	l ₁	l ₂	l ₃	l ₄	Spezifikation	Bestell-Nr.
12,00	12	162	114	96	45	SCD411-1200-2-3-135HA08-HP374	31159474
12,20	14	178	133	112	45	SCD411-1220-2-3-135HA08-HP374	31159475
12,50	14	178	133	112	45	SCD411-1250-2-3-135HA08-HP374	31159476
12,80	14	178	133	112	45	SCD411-1280-2-3-135HA08-HP374	31159477
13,00	14	178	133	112	45	SCD411-1300-2-3-135HA08-HP374	31159478
13,50	14	178	133	112	45	SCD411-1350-2-3-135HA08-HP374	31159479
13,80	14	178	133	112	45	SCD411-1380-2-3-135HA08-HP374	31159480
14,00	14	178	133	112	45	SCD411-1400-2-3-135HA08-HP374	31159481
14,20	16	203	152	128	48	SCD411-1420-2-3-135HA08-HP374	31159482
14,50	16	203	152	128	48	SCD411-1450-2-3-135HA08-HP374	31159483
14,80	16	203	152	128	48	SCD411-1480-2-3-135HA08-HP374	31159484
15,00	16	203	152	128	48	SCD411-1500-2-3-135HA08-HP374	31159485
15,20	16	203	152	128	48	SCD411-1520-2-3-135HA08-HP374	31159486
15,50	16	203	152	128	48	SCD411-1550-2-3-135HA08-HP374	31159487
15,80	16	203	152	128	48	SCD411-1580-2-3-135HA08-HP374	31159488
16,00	16	203	152	128	48	SCD411-1600-2-3-135HA08-HP374	31159489
16,50	18	222	171	144	48	SCD411-1650-2-3-135HA08-HP374	31159490
16,80	18	222	171	144	48	SCD411-1680-2-3-135HA08-HP374	31159491
17,00	18	222	171	144	48	SCD411-1700-2-3-135HA08-HP374	31159492
17,50	18	222	171	144	48	SCD411-1750-2-3-135HA08-HP374	31159493
17,80	18	222	171	144	48	SCD411-1780-2-3-135HA08-HP374	31159494
18,00	18	222	171	144	48	SCD411-1800-2-3-135HA08-HP374	31159495
18,50	20	243	190	160	50	SCD411-1850-2-3-135HA08-HP374	31159496
18,80	20	243	190	160	50	SCD411-1880-2-3-135HA08-HP374	31159497
19,00	20	243	190	160	50	SCD411-1900-2-3-135HA08-HP374	31159498
19,50	20	243	190	160	50	SCD411-1950-2-3-135HA08-HP374	31159499
19,80	20	243	190	160	50	SCD411-1980-2-3-135HA08-HP374	31159500
20,00	20	243	190	160	50	SCD411-2000-2-3-135HA08-HP374	31159501

Konfigurierbare Merkmale



Durchmesser:
Durchmesser in Abstufungen
von 0,01 mm frei wählbar



Schaftform:
Schaftform: HB | HE

Spezifikation:

SCD411-[Durchmesser]-2-3-135[Schaftform]08-HP374

Abmessungen konfigurierbare Baureihe

d ₁ min.	d ₁ max.	d ₂ h6	l ₁	l ₂	l ₃	l ₄
3,00	3,70	6	72	34	29	36
3,71	4,70	6	81	43	36	36
4,71	6,00	6	95	57	48	36
6,01	8,00	8	114	76	64	36
8,01	10,00	10	142	95	80	40
10,01	12,00	12	162	114	96	45
12,01	14,00	14	178	133	112	45
14,01	16,00	16	203	152	128	48
16,01	18,00	18	222	171	144	48
18,01	20,00	20	243	190	160	50

Beispiel:

SCD411-0431-2-3-140HE08-HP374

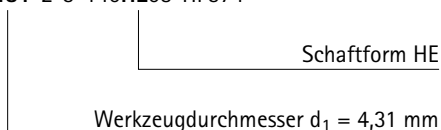

Maßangaben in mm.

Schnittwertempfehlung siehe Kapitelende.

Sonderausführungen und andere Beschichtungen auf Anfrage.

MEGA-Speed-Drill-Inox

Vollhartmetall-Spiralbohrer
SCD411 (12xD), innere Kühlmittelzufuhr

Ausführung:

Bohrerdurchmesser: 3,00 – 20,00 mm
Bohrungstoleranz: \geq IT 9
Schneidstoff: HP374
Schneidenanzahl: 2
Anzahl Führungsfasen: 3
Spitzenwinkel: 135°
Spiralwinkel: 30°

Anwendung:

Für Hochgeschwindigkeitsbearbeitung.

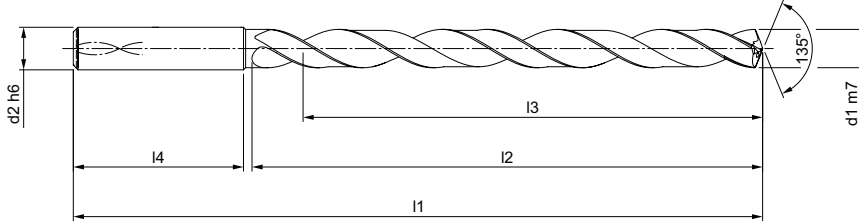
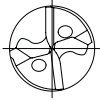

Lagerhaltige Vorzugsbaureihe in Schaftform HA

Baumaße						Schaftform HA	
d ₁ m7	d ₂ h6	l ₁	l ₂	l ₃	l ₄	Spezifikation	Bestell-Nr.
3,00	6	92	54	48	36	SCD411-0300-2-3-135HA12-HP374	31132678
3,10	6	92	54	48	36	SCD411-0310-2-3-135HA12-HP374	31132679
3,20	6	92	54	48	36	SCD411-0320-2-3-135HA12-HP374	31132690
3,30	6	92	54	48	36	SCD411-0330-2-3-135HA12-HP374	31132691
3,40	6	92	54	48	36	SCD411-0340-2-3-135HA12-HP374	31132692
3,50	6	92	54	48	36	SCD411-0350-2-3-135HA12-HP374	31132693
3,70	6	92	54	48	36	SCD411-0370-2-3-135HA12-HP374	31132695
4,00	6	102	64	58	36	SCD411-0400-2-3-135HA12-HP374	31132698
4,10	6	102	64	58	36	SCD411-0410-2-3-135HA12-HP374	31132699
4,20	6	102	64	58	36	SCD411-0420-2-3-135HA12-HP374	31132700
4,30	6	102	64	58	36	SCD411-0430-2-3-135HA12-HP374	31132701
4,50	6	102	64	58	36	SCD411-0450-2-3-135HA12-HP374	31132703
4,80	6	116	78	70	36	SCD411-0480-2-3-135HA12-HP374	31132706
5,00	6	116	78	70	36	SCD411-0500-2-3-135HA12-HP374	31132708
5,10	6	116	78	70	36	SCD411-0510-2-3-135HA12-HP374	31132709
5,20	6	116	78	70	36	SCD411-0520-2-3-135HA12-HP374	31132710
5,40	6	116	78	70	36	SCD411-0540-2-3-135HA12-HP374	31132712
5,50	6	116	78	70	36	SCD411-0550-2-3-135HA12-HP374	31132713
5,80	6	116	78	70	36	SCD411-0580-2-3-135HA12-HP374	31132716
6,00	6	116	78	70	36	SCD411-0600-2-3-135HA12-HP374	31132718
6,10	8	146	108	94	36	SCD411-0610-2-3-135HA12-HP374	31132719
6,20	8	146	108	94	36	SCD411-0620-2-3-135HA12-HP374	31132720
6,50	8	146	108	94	36	SCD411-0650-2-3-135HA12-HP374	31132723
6,80	8	146	108	94	36	SCD411-0680-2-3-135HA12-HP374	31132726
7,00	8	146	108	94	36	SCD411-0700-2-3-135HA12-HP374	31132728
7,50	8	146	108	94	36	SCD411-0750-2-3-135HA12-HP374	31132733
7,80	8	146	108	94	36	SCD411-0780-2-3-135HA12-HP374	31132736
8,00	8	146	108	94	36	SCD411-0800-2-3-135HA12-HP374	31132738
8,50	10	162	120	110	40	SCD411-0850-2-3-135HA12-HP374	31132743
9,00	10	162	120	110	40	SCD411-0900-2-3-135HA12-HP374	31132748
9,10	10	162	120	110	40	SCD411-0910-2-3-135HA12-HP374	31132749
9,50	10	162	120	110	40	SCD411-0950-2-3-135HA12-HP374	31132753
9,70	10	162	120	110	40	SCD411-0970-2-3-135HA12-HP374	31132755
9,80	10	162	120	110	40	SCD411-0980-2-3-135HA12-HP374	31132756
10,00	10	162	120	110	40	SCD411-1000-2-3-135HA12-HP374	31132758

MEGA-Speed-Drill-Inox | Vollhartmetall-Spiralbohrer SCD411 (12xD), innere Kühlmittelzufuhr

Baumaße						Schaftform HA	
d ₁ m7	d ₂ h6	l ₁	l ₂	l ₃	l ₄	Spezifikation	Bestell-Nr.
10,10	12	204	156	142	45	SCD411-1010-2-3-135HA12-HP374	31132759
10,20	12	204	156	142	45	SCD411-1020-2-3-135HA12-HP374	31132760
10,50	12	204	156	142	45	SCD411-1050-2-3-135HA12-HP374	31132763
11,00	12	204	156	142	45	SCD411-1100-2-3-135HA12-HP374	31132768
11,80	12	204	156	142	45	SCD411-1180-2-3-135HA12-HP374	31132776
12,00	12	204	156	142	45	SCD411-1200-2-3-135HA12-HP374	31132778
12,50	14	230	182	166	45	SCD411-1250-2-3-135HA12-HP374	31132780
12,80	14	230	182	166	45	SCD411-1280-2-3-135HA12-HP374	31132781
13,00	14	230	182	166	45	SCD411-1300-2-3-135HA12-HP374	31132782
13,50	14	230	182	166	45	SCD411-1350-2-3-135HA12-HP374	31132783
14,00	14	230	182	166	45	SCD411-1400-2-3-135HA12-HP374	31132785
15,00	16	260	208	192	48	SCD411-1500-2-3-135HA12-HP374	31132788
16,00	16	260	208	192	48	SCD411-1600-2-3-135HA12-HP374	31132793

Konfigurierbare Merkmale



Durchmesser:
Durchmesser in Abstufungen
von 0,01 mm frei wählbar



Schaftform:
Schaftform: HB | HE

Spezifikation:

SCD411-[Durchmesser]-2-3-135[Schaftform]12-HP374

Abmessungen konfigurierbare Baureihe

d ₁ min.	d ₁ max.	d ₂ h6	l ₁	l ₂	l ₃	l ₄
3,00	3,70	6	92	54	48	36
3,71	4,70	6	102	64	58	36
4,71	6,00	6	116	78	70	36
6,01	8,00	8	146	108	94	36
8,01	10,00	10	162	120	110	40
10,01	12,00	12	204	156	142	45
12,01	14,00	14	230	182	166	45
14,01	16,00	16	260	208	192	48
16,01	18,00	18	285	234	216	48
18,01	20,00	20	310	258	240	50

Beispiel:

SCD411-0431-2-3-140HE12-HP374

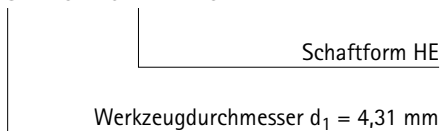

Maßangaben in mm.

Schnittwertempfehlung siehe Kapitelende.

Sonderausführungen und andere Beschichtungen auf Anfrage.

MEGA-Speed-Drill-Iron

Vollhartmetall-Spiralbohrer
SCD421 (5xD), innere Kühlmittelzufuhr

Ausführung:
Bohrerdurchmesser: 3,00 – 20,00 mm
Bohrungstoleranz: ≥ IT 9
Schneidstoff: HP238
Schneidenanzahl: 2
Anzahl Führungsfasen: 3
Spitzenwinkel: 130°
Spiralwinkel: 30°

Anwendung:
Für Hochgeschwindigkeitsbearbeitung.

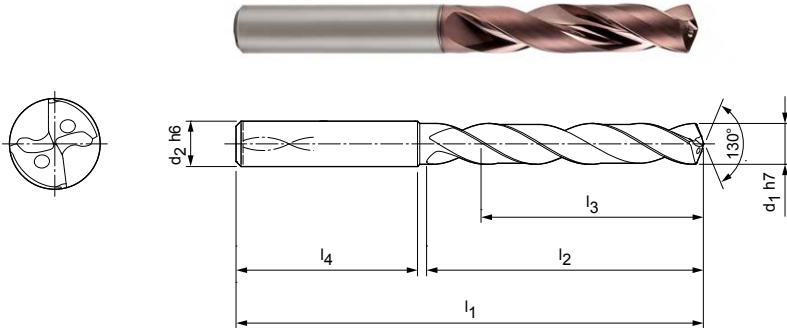

Lagerhaltige Vorzugsbaureihe in Schaftform HA

Baumaße						Schaftform HA	
d ₁ h7	d ₂ h6	l ₁	l ₂	l ₃	l ₄	Spezifikation	Bestell-Nr.
5,00	6	82	44	35	36	SCD421-0500-2-3-130HA05-HP238	30488320
5,10	6	82	44	35	36	SCD421-0510-2-3-130HA05-HP238	30488321
6,00	6	82	44	35	36	SCD421-0600-2-3-130HA05-HP238	30488331
6,90	8	91	53	43	36	SCD421-0690-2-3-130HA05-HP238	30488340
7,00	8	91	53	43	36	SCD421-0700-2-3-130HA05-HP238	30488341
7,20	8	91	53	43	36	SCD421-0720-2-3-130HA05-HP238	30488343
8,10	10	103	61	49	40	SCD421-0810-2-3-130HA05-HP238	30488352
8,50	10	103	61	49	40	SCD421-0850-2-3-130HA05-HP238	30488356
9,00	10	103	61	49	40	SCD421-0900-2-3-130HA05-HP238	30488361
14,00	14	124	77	60	45	SCD421-1400-2-3-130HA05-HP238	30488397
17,50	18	143	93	71	48	SCD421-1750-2-3-130HA05-HP238	30488407

Konfigurierbare Merkmale

Durchmesser:
Durchmesser in Abstufungen
von 0,01 mm frei wählbar

Schaftform:
Schaftform: HB | HE

Spezifikation:
SCD421-[Durchmesser]-2-3-130[Schaftform]05-HP238

Abmessungen konfigurierbare Baureihe

d ₁ min.	d ₁ max.	d ₂ h6	l ₁	l ₂	l ₃	l ₄
3,00	3,70	6	66	28	23	36
3,71	4,79	6	74	36	29	36
4,80	6,00	6	82	44	35	36
6,01	8,00	8	91	53	43	36
8,01	10,00	10	103	61	49	40
10,01	12,00	12	118	71	56	45
12,01	14,00	14	124	77	60	45
14,01	16,00	16	133	83	63	48
16,01	18,00	18	143	93	71	48
18,01	20,00	20	153	101	77	50

Beispiel:
SCD421-0431-2-3-130HE05-HP238

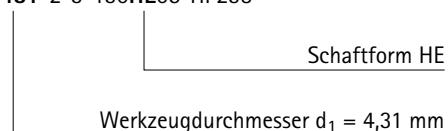

Maßangaben in mm.
Schnittwertempfehlung siehe Kapitelende.
Sonderausführungen und andere Beschichtungen auf Anfrage.

MEGA-Drill-Alu

Vollhartmetall-Spiralbohrer
SCD131 (3xD), innere Kühlmittelzufuhr

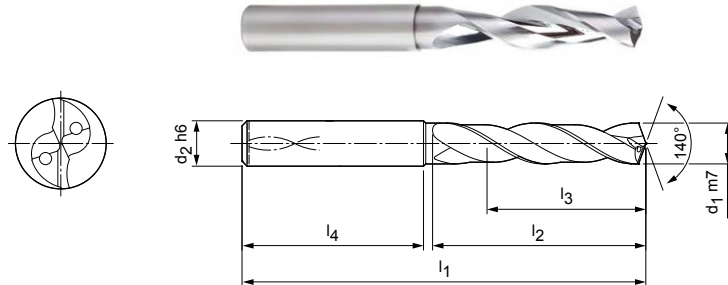

Ausführung:

Bohrerdurchmesser: 3,00 – 20,00 mm
Bohrungstoleranz: \geq IT 9
Schneidstoff: HU630
Schneidenanzahl: 2
Anzahl Führungsfasen: 2
Spitzenwinkel: 140°
Spiralwinkel: 30°

Anwendung:

Als Pilotbohrer für MEGA-Deep-Drill-Alu geeignet.



Lagerhaltige Vorzugsbaureihe in Schaftform HA

Baumaße						Schaftform HA	
d ₁ m7	d ₂ h6	l ₁	l ₂	l ₃	l ₄	Spezifikation	Bestell-Nr.
6,50	8	79	34	24	36	SCD131-0650-2-2-140HA03-HU630	30394280
6,70	8	79	34	24	36	SCD131-0670-2-2-140HA03-HU630	30446643
7,00	8	79	34	24	36	SCD131-0700-2-2-140HA03-HU630	30391294
10,00	10	89	47	35	40	SCD131-1000-2-2-140HA03-HU630	30391297
11,00	12	102	55	40	45	SCD131-1100-2-2-140HA03-HU630	30391298
12,00	12	102	55	40	45	SCD131-1200-2-2-140HA03-HU630	30391299
13,20	14	107	60	43	45	SCD131-1320-2-2-140HA03-HU630	30694326
13,70	14	107	60	43	45	SCD131-1370-2-2-140HA03-HU630	30694329
16,00	16	115	65	45	48	SCD131-1600-2-2-140HA03-HU630	30391303

Konfigurierbare Merkmale



Durchmesser:
Durchmesser in Abstufungen
von 0,01 mm frei wählbar



Schaftform:
Schaftform: HB | HE

Spezifikation:

SCD131-[Durchmesser]-2-2-140[Schaftform]03-HU630

Beispiel:

SCD131-0431-2-3-140HE03-HU630

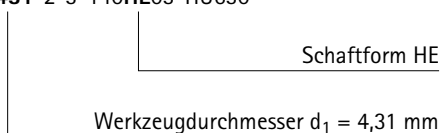

Abmessungen konfigurierbare Baureihe

d ₁ min.	d ₁ max.	d ₂ h6	l ₁	l ₂	l ₃	l ₄
3,00	3,50	6	62	20	14	36
3,51	4,50	6	66	24	17	36
4,51	6,00	6	66	28	20	36
6,01	7,97	8	79	34	24	36
7,98	8,00	8	79	41	29	36
8,01	10,00	10	89	47	35	40
10,01	12,00	12	102	55	40	45
12,01	14,00	14	107	60	43	45
14,01	16,00	16	115	65	45	48
16,01	18,00	18	123	73	51	48
18,01	20,00	20	131	79	55	50

Maßangaben in mm.

Schnittwertempfehlung siehe Kapitelende.

Sonderausführungen und andere Beschichtungen auf Anfrage.

MEGA-Drill-Alu

Vollhartmetall-Spiralbohrer
SCD131 (5xD), innere Kühlmittelzufuhr

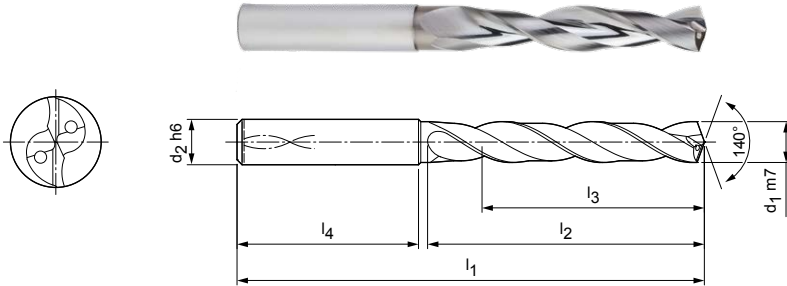

Ausführung:

Bohrerdurchmesser:	2,80 – 20,00 mm
Bohrungstoleranz:	≥ IT 9
Schneidstoff:	HU630
Schneidenanzahl:	2
Anzahl Führungsfasen:	2
Spitzenwinkel:	140°
Spiralwinkel:	30°

Anwendung:

Als Pilotbohrer für MEGA-Deep-Drill-Alu geeignet.



Lagerhaltige Vorzugsbaureihe in Schaftform HA

Baumaße						Schaftform HA	
d ₁ m7	d ₂ h6	l ₁	l ₂	l ₃	l ₄	Spezifikation	Bestell-Nr.
3,00	6	66	28	23	36	SCD131-0300-2-2-140HA05-HU630	30391326
3,20	6	66	28	23	36	SCD131-0320-2-2-140HA05-HU630	30391328
3,30	6	66	28	23	36	SCD131-0330-2-2-140HA05-HU630	30391329
3,50	6	66	28	23	36	SCD131-0350-2-2-140HA05-HU630	30391331
3,70*	6	66	28	23	36	SCD131-0370-2-2-140HA05-HU630	30391333
3,90	6	74	36	29	36	SCD131-0390-2-2-140HA05-HU630	30391335
4,00	6	74	36	29	36	SCD131-0400-2-2-140HA05-HU630	30391336
4,10	6	74	36	29	36	SCD131-0410-2-2-140HA05-HU630	30391337
4,20	6	74	36	29	36	SCD131-0420-2-2-140HA05-HU630	30391338
4,30	6	74	36	29	36	SCD131-0430-2-2-140HA05-HU630	30391339
4,50	6	74	36	29	36	SCD131-0450-2-2-140HA05-HU630	30391341
4,60	6	74	36	29	36	SCD131-0460-2-2-140HA05-HU630	30391342
4,70	6	74	36	29	36	SCD131-0470-2-2-140HA05-HU630	30391343
5,00	6	82	44	35	36	SCD131-0500-2-2-140HA05-HU630	30391346
5,10	6	82	44	35	36	SCD131-0510-2-2-140HA05-HU630	30391347
5,20	6	82	44	35	36	SCD131-0520-2-2-140HA05-HU630	30391348
5,50	6	82	44	35	36	SCD131-0550-2-2-140HA05-HU630	30391351
5,60	6	82	44	35	36	SCD131-0560-2-2-140HA05-HU630	30391352
6,00	6	82	44	35	36	SCD131-0600-2-2-140HA05-HU630	30391356
6,10	8	91	53	43	36	SCD131-0610-2-2-140HA05-HU630	30391357
6,20	8	91	53	43	36	SCD131-0620-2-2-140HA05-HU630	30391358
6,30	8	91	53	43	36	SCD131-0630-2-2-140HA05-HU630	30391359
6,40	8	91	53	43	36	SCD131-0640-2-2-140HA05-HU630	30391360
6,50	8	91	53	43	36	SCD131-0650-2-2-140HA05-HU630	30391361
6,60	8	91	53	43	36	SCD131-0660-2-2-140HA05-HU630	30391362
6,80	8	91	53	43	36	SCD131-0680-2-2-140HA05-HU630	30391364
7,00	8	91	53	43	36	SCD131-0700-2-2-140HA05-HU630	30391366
7,40	8	91	53	43	36	SCD131-0740-2-2-140HA05-HU630	30391370
7,50	8	91	53	43	36	SCD131-0750-2-2-140HA05-HU630	30391371
7,60	8	91	53	43	36	SCD131-0760-2-2-140HA05-HU630	30391372
8,00	8	91	53	43	36	SCD131-0800-2-2-140HA05-HU630	30391376
8,40	10	103	61	49	40	SCD131-0840-2-2-140HA05-HU630	30391380
8,50	10	103	61	49	40	SCD131-0850-2-2-140HA05-HU630	30391381
8,73	10	103	61	49	40	SCD131-0873-2-2-140HA05-HU630	30451167
8,90	10	103	61	49	40	SCD131-0890-2-2-140HA05-HU630	30391385

MEGA-Drill-Alu | Vollhartmetall-Spiralbohrer SCD131 (5xD), innere Kühlmittelzufuhr

Baumaße						Schaftform HA	
d ₁ m7	d ₂ h6	l ₁	l ₂	l ₃	l ₄	Spezifikation	Bestell-Nr.
9,00	10	103	61	49	40	SCD131-0900-2-2-140HA05-HU630	30391386
9,20	10	103	61	49	40	SCD131-0920-2-2-140HA05-HU630	30391388
9,30*	10	103	61	49	40	SCD131-0930-2-2-140HA05-HU630	30391389
9,50	10	103	61	49	40	SCD131-0950-2-2-140HA05-HU630	30391391
9,60	10	103	61	49	40	SCD131-0960-2-2-140HA05-HU630	30391392
10,00	10	103	61	49	40	SCD131-1000-2-2-140HA05-HU630	30391396
10,20	12	118	71	56	45	SCD131-1020-2-2-140HA05-HU630	30391398
10,50	12	118	71	56	45	SCD131-1050-2-2-140HA05-HU630	30391401
10,80	12	118	71	56	45	SCD131-1080-2-2-140HA05-HU630	30391404
11,00	12	118	71	56	45	SCD131-1100-2-2-140HA05-HU630	30391406
11,50	12	118	71	56	45	SCD131-1150-2-2-140HA05-HU630	30391407
12,00	12	118	71	56	45	SCD131-1200-2-2-140HA05-HU630	30391408
12,50	14	124	77	60	45	SCD131-1250-2-2-140HA05-HU630	30391409
13,50	14	124	77	60	45	SCD131-1350-2-2-140HA05-HU630	30391411
14,00	14	124	77	60	45	SCD131-1400-2-2-140HA05-HU630	30391412
16,00	16	133	83	63	48	SCD131-1600-2-2-140HA05-HU630	30391418
20,00	20	153	101	77	50	SCD131-2000-2-2-140HA05-HU630	30446886

Konfigurierbare Merkmale



Durchmesser:
Durchmesser in Abstufungen
von 0,01 mm frei wählbar



Schaftform:
Schaftform: HB | HE

Spezifikation:

SCD131-[Durchmesser]-2-2-140[Schaftform]05-HU630

Abmessungen konfigurierbare Baureihe

d ₁ min.	d ₁ max.	d ₂ h6	l ₁	l ₂	l ₃	l ₄
2,80	3,70	6	66	28	23	36
3,71	4,70	6	74	36	29	36
4,71	6,00	6	82	44	35	36
6,01	8,00	8	91	53	43	36
8,01	10,00	10	103	61	49	40
10,01	12,00	12	118	71	56	45
12,01	14,00	14	124	77	60	45
14,01	16,00	16	133	83	63	48
16,01	18,00	18	143	93	71	48
18,01	20,00	20	153	101	77	50

Beispiel:

SCD131-0431-2-2-140HE05-HU630

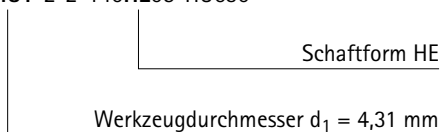

Maßangaben in mm.

* Speziell zur Vorfertigung der Kernlöcher für Gewindeformer geeignet.

Schnittwertempfehlung siehe Kapitelende.

Sonderausführungen und andere Beschichtungen auf Anfrage.

MEGA-Drill-Alu

Vollhartmetall-Spiralbohrer
SCD131 (8xD), innere Kühlmittelzufuhr

Ausführung:

Bohrerdurchmesser: 3,00 – 20,00 mm
Bohrungstoleranz: ≥ IT 9
Schneidstoff: HU630
Schneidenanzahl: 2
Anzahl Führungsfasen: 2
Spitzenwinkel: 140°
Spiralwinkel: 30°

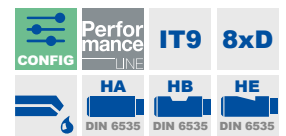
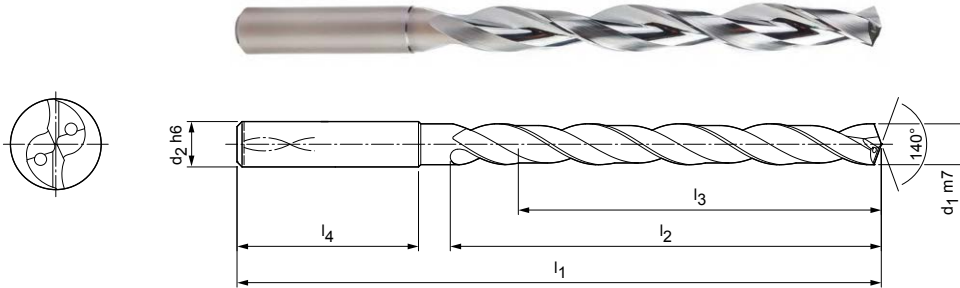

Lagerhaltige Vorzugsbaureihe in Schaftform HA

Baumaße						Schaftform HA	
d ₁ m7	d ₂ h6	l ₁	l ₂	l ₃	l ₄	Spezifikation	Bestell-Nr.
3,00	6	72	34	29	36	SCD131-0300-2-2-140HA08-HU630	30391421
3,30	6	72	34	29	36	SCD131-0330-2-2-140HA08-HU630	30391424
3,50	6	72	34	29	36	SCD131-0350-2-2-140HA08-HU630	30391426
3,70	6	72	34	29	36	SCD131-0370-2-2-140HA08-HU630	30391428
4,00	6	81	43	36	36	SCD131-0400-2-2-140HA08-HU630	30391431
4,50	6	81	43	36	36	SCD131-0450-2-2-140HA08-HU630	30391436
5,00	6	95	57	48	36	SCD131-0500-2-2-140HA08-HU630	30391441
5,50	6	95	57	48	36	SCD131-0550-2-2-140HA08-HU630	30391446
6,50	8	114	76	64	36	SCD131-0650-2-2-140HA08-HU630	30391457
6,80	8	114	76	64	36	SCD131-0680-2-2-140HA08-HU630	30391460
7,00	8	114	76	64	36	SCD131-0700-2-2-140HA08-HU630	30391462
8,00	8	114	76	64	36	SCD131-0800-2-2-140HA08-HU630	30391472
9,30	10	142	95	80	40	SCD131-0930-2-2-140HA08-HU630	30391484
11,00	12	162	114	96	45	SCD131-1100-2-2-140HA08-HU630	30391500
12,00	12	162	114	96	45	SCD131-1200-2-2-140HA08-HU630	30391510

Konfigurierbare Merkmale



Durchmesser:
Durchmesser in Abstufungen von 0,01 mm frei wählbar



Schaftform:
Schaftform: HB | HE

Spezifikation:

SCD131-[Durchmesser]-2-2-140[Schaftform]08-HU630

Abmessungen konfigurierbare Baureihe

d ₁ min.	d ₁ max.	d ₂ h6	l ₁	l ₂	l ₃	l ₄
3,00	3,70	6	72	34	29	36
3,71	4,70	6	81	43	36	36
4,71	6,00	6	95	57	48	36
6,01	8,00	8	114	76	64	36
8,01	10,00	10	142	95	80	40
10,01	12,00	12	162	114	96	45
12,01	14,00	14	178	133	112	45
14,01	16,00	16	203	152	128	48
16,01	18,00	18	222	171	144	48
18,01	20,00	20	243	190	160	50

Beispiel:

SCD131-0431-2-2-140HE08-HU630

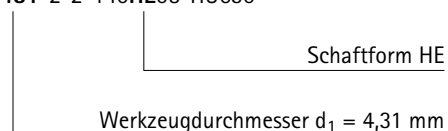

Maßangaben in mm.
Schnittwertempfehlung siehe Kapitelende.
Sonderausführungen und andere Beschichtungen auf Anfrage.

MEGA-Drill-Alu

Vollhartmetall-Spiralbohrer
SCD131 (12xD), innere Kühlmittelzufuhr

Ausführung:

Bohrerdurchmesser: 3,00 – 20,00 mm
Bohrungstoleranz: \geq IT 9
Schneidstoff: HU630
Schneidenanzahl: 2
Anzahl Führungsfasen: 2
Spitzenwinkel: 140°
Spiralwinkel: 30°

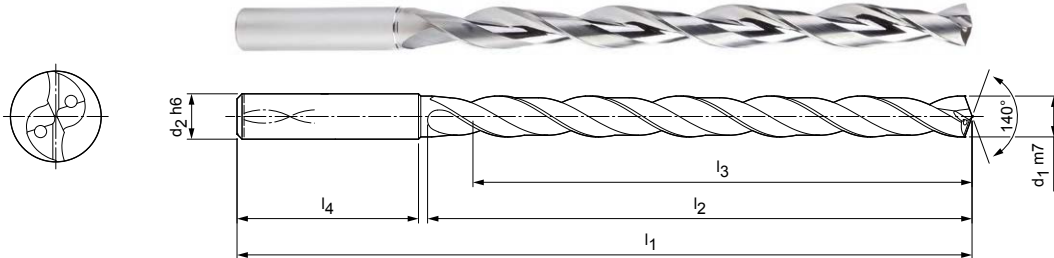

Lagerhaltige Vorzugsbaureihe in Schaftform HA

Baumaße						Schaftform HA	
d_1 m7	d_2 h6	l_1	l_2	l_3	l_4	Spezifikation	Bestell-Nr.
3,00	6	92	54	48	36	SCD131-0300-2-2-140HA12-HU630	30391519
3,50	6	92	54	48	36	SCD131-0350-2-2-140HA12-HU630	30391524
4,00	6	102	64	58	36	SCD131-0400-2-2-140HA12-HU630	30391529
4,70	6	102	64	58	36	SCD131-0470-2-2-140HA12-HU630	30391536
5,00	6	116	78	70	36	SCD131-0500-2-2-140HA12-HU630	30391539
5,40	6	116	78	70	36	SCD131-0540-2-2-140HA12-HU630	30391543
5,50	6	116	78	70	36	SCD131-0550-2-2-140HA12-HU630	30391544
5,60	6	116	78	70	36	SCD131-0560-2-2-140HA12-HU630	30391545
6,00	6	116	78	70	36	SCD131-0600-2-2-140HA12-HU630	30391549
6,50	8	146	108	94	36	SCD131-0650-2-2-140HA12-HU630	30391554
6,60	8	146	108	94	36	SCD131-0660-2-2-140HA12-HU630	30391555
7,00	8	146	108	94	36	SCD131-0700-2-2-140HA12-HU630	30391558
8,00	8	146	108	94	36	SCD131-0800-2-2-140HA12-HU630	30391568
9,00	10	162	120	110	40	SCD131-0900-2-2-140HA12-HU630	30391577

Konfigurierbare Merkmale



Durchmesser:
Durchmesser in Abstufungen
von 0,01 mm frei wählbar



Schaftform:
Schaftform: HB | HE

Spezifikation:

SCD131-[Durchmesser]-2-2-140[Schaftform]12-HU630

Abmessungen konfigurierbare Baureihe

d_1 min.	d_1 max.	d_2 h6	l_1	l_2	l_3	l_4
3,00	3,70	6	92	54	48	36
3,71	4,70	6	102	64	58	36
4,71	6,00	6	116	78	70	36
6,01	8,00	8	146	108	94	36
8,01	10,00	10	162	120	110	40
10,01	12,00	12	204	156	142	45
12,01	14,00	14	230	182	166	45
14,01	16,00	16	260	208	192	48
16,01	18,00	18	285	234	216	48
18,01	20,00	20	310	258	240	50

Beispiel:

SCD131-0431-2-2-140HE12-HU630

Schaftform HE

Werkzeugdurchmesser $d_1 = 4,31$ mm

Maßangaben in mm.

Schnittwertempfehlung siehe Kapitelende.

Sonderausführungen und andere Beschichtungen auf Anfrage.

MEGA-Drill-Composite-MD

Vollhartmetall-Spiralbohrer
SCD250 (5xD), äußere Kühlmittelzufuhr

Ausführung:
Bohrerdurchmesser: 0,50 – 12,00 mm
Schneidstoff: HC611/619/620
Schneidenanzahl: 2
Anzahl Führungsfasen: 2
Spitzenwinkel: 90°
Spiralwinkel: 35°

Anwendung:
CFK mit multidirektionalem Faserverlauf.

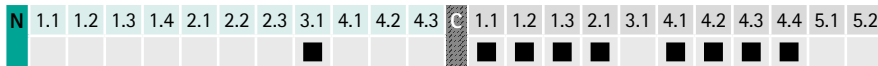
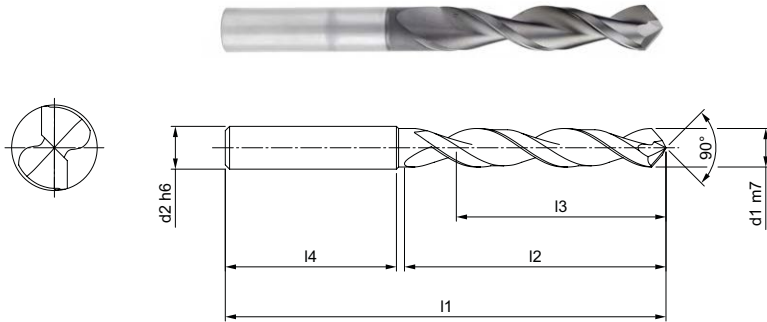

Baumaße						Schaftform HA	
d ₁ m7	d ₂ h6	l ₁	l ₂	l ₃	l ₄	Spezifikation	Bestell-Nr.
0,50	3	55	4,5	3	46	SCD250-0050-2-2-140HA05-HC620	30504673
2,00	3	68	14	11	51	SCD250-0200-2-2-140HA05-HC620	30504688
2,50	3	74	18	14	54	SCD250-0250-2-2-140HA05-HC620	30504693
3,00	6	66	28	23	36	SCD250-0300-2-2-090HA05-HC619	30401902
3,10	6	66	28	23	36	SCD250-0310-2-2-090HA05-HC619	30401903
3,20	6	66	28	23	36	SCD250-0320-2-2-090HA05-HC619	30401905
3,30	6	66	28	23	36	SCD250-0330-2-2-090HA05-HC619	30401906
3,80	6	66	28	23	36	SCD250-0380-2-2-090HA05-HC619	30401911
4,00	6	74	36	29	36	SCD250-0400-2-2-090HA05-HC619	30401913
4,10	6	74	36	29	36	SCD250-0410-2-2-090HA05-HC619	30401914
4,20	6	74	36	29	36	SCD250-0420-2-2-090HA05-HC619	30401915
4,30	6	74	36	29	36	SCD250-0430-2-2-090HA05-HC619	30401916
4,50	6	74	36	29	36	SCD250-0450-2-2-090HA05-HC619	30401918
4,80	6	74	36	29	36	SCD250-0480-2-2-090HA05-HC619	30401922
4,86	6	74	36	0	36	SCD250-0486-2-2-090HA05-HC619	30681789
5,00	6	82	44	35	36	SCD250-0500-2-2-090HA05-HC619	30401924
5,10	6	82	44	35	36	SCD250-0510-2-2-090HA05-HC619	30401925
5,20	6	82	44	35	36	SCD250-0520-2-2-090HA05-HC619	30401926
5,30	6	82	44	35	36	SCD250-0530-2-2-090HA05-HC619	30401927
5,50	6	82	44	35	36	SCD250-0550-2-2-090HA05-HC619	30401929
5,60	6	82	44	35	36	SCD250-0560-2-2-090HA05-HC619	30401930
5,80	6	82	44	35	36	SCD250-0580-2-2-090HA05-HC619	30401932
6,00	6	82	44	35	36	SCD250-0600-2-2-090HA05-HC619	30401934
6,50	8	91	53	43	36	SCD250-0650-2-2-090HA05-HC619	30401940
6,80	8	91	53	43	36	SCD250-0680-2-2-090HA05-HC619	30401943
7,00	8	91	53	43	36	SCD250-0700-2-2-090HA05-HC619	30401945
7,20	8	91	53	43	36	SCD250-0720-2-2-090HA05-HC619	30401947
7,50	8	91	53	43	36	SCD250-0750-2-2-090HA05-HC619	30401950
7,80	8	91	53	43	36	SCD250-0780-2-2-090HA05-HC619	30401953
8,00	8	91	53	43	36	SCD250-0800-2-2-090HA05-HC619	30401956
8,50	10	103	61	49	40	SCD250-0850-2-2-090HA05-HC611	30401961
8,80	10	103	61	49	40	SCD250-0880-2-2-090HA05-HC611	30401964
10,00	10	103	61	49	40	SCD250-1000-2-2-090HA05-HC611	30401977

MEGA-Drill-Composite-MD | Vollhartmetall-Spiralbohrer SCD250 (5xD), äußere Kühlmittelzufuhr

Baumaße						Schaftform HA	
d ₁ m7	d ₂ h6	l ₁	l ₂	l ₃	l ₄	Spezifikation	Bestell-Nr.
10,10	12	118	71	56	45	SCD250-1010-2-2-090HA05-HC611	30401978
10,40	12	118	71	56	45	SCD250-1040-2-2-090HA05-HC611	30401981
10,70	12	118	71	56	45	SCD250-1070-2-2-090HA05-HC611	30401984
12,00	12	118	71	56	45	SCD250-1200-2-2-090HA05-HC611	30401998

Konfigurierbare Merkmale

**Durchmesser:**

Durchmesser in Abstufungen von 0,01 mm frei wählbar

**Schaftform:**

Schaftform: HB | HE

Spezifikation:

SCD250-[Durchmesser]-2-2-090[Schaftform]05-HC611

Abmessungen konfigurierbare Baureihe

d ₁ min.	d ₁ max.	d ₂ h6	l ₁	l ₂	l ₃	l ₄
3,00	3,99	6	66	28	23	36
4,00	4,99	6	74	36	29	36
5,00	6,00	6	82	44	35	36
6,01	8,00	8	91	53	43	36
8,01	10,00	10	103	61	49	40
10,01	12,00	12	118	71	56	45

Beispiel:

SCD250-0431-2-2-090HE05-HC611

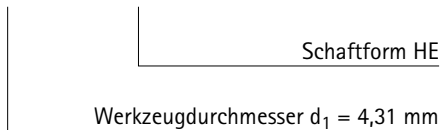

Maßangaben in mm.

Schnittwertempfehlung siehe Kapitelende.

Sonderausführungen und andere Beschichtungen auf Anfrage.

MEGA-Drill-Composite-UDX

Vollhartmetall-Spiralbohrer
SCD270 (5xD), äußere Kühlmittelzufuhr

Ausführung:

Bohrerdurchmesser: 3,00 – 12,00 mm
Bohrungstoleranz: ≥ IT 8
Schneidstoff: HC619
Schneidenanzahl: 2
Anzahl Führungsfasen: 4
Spitzenwinkel: 90°
Spiralwinkel: 35°

Anwendung:

Für alle CFK-Werkstoffe / Problemlöser bei labilen Spannsituationen oder dünnwandigen Bauteilen.

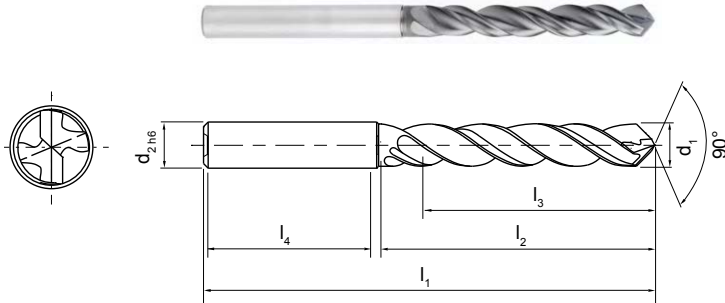

Lagerhaltige Vorzugsbaureihe in Schaftform HA

Baumaße						Schaftform HA	
d ₁ m7	d ₂ h6	l ₁	l ₂	l ₃	l ₄	Spezifikation	Bestell-Nr.
3,30	6	66	26	20	36	SCD270-0330-2-2-090HA05-HC619	30402105
4,00	6	74	35	27	36	SCD270-0400-2-2-090HA05-HC619	30402112
4,394	6	74	35	27	36	SCD270-04394-2-2-090HA05-HC619	30634827
4,50	6	74	35	27	36	SCD270-0450-2-2-090HA05-HC619	30402117
5,00	6	82	44	35	36	SCD270-0500-2-2-090HA05-HC619	30402123

Konfigurierbare Merkmale

Durchmesser:
Durchmesser in Abstufungen von 0,01 mm frei wählbar

Schaftform:
Schaftform: HB | HE

Spezifikation:
SCD270-[Durchmesser]-2-2-090[Schaftform]05-HC619

Abmessungen konfigurierbare Baureihe

d ₁ min.	d ₁ max.	d ₂ h6	l ₁	l ₂	l ₃	l ₄
3,00	3,99	6	66	26	20	36
4,00	4,99	6	74	35	27	36
5,00	6,00	6	82	44	35	36
6,01	8,00	8	91	52	40	36
8,01	10,00	10	103	60	45	40
10,01	12,00	12	118	70	52	45

Beispiel:
SCD270-0431-2-2-090HE05-HC619

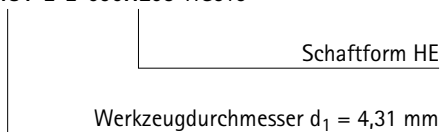

Maßangaben in mm.
Schnittwertempfehlung siehe Kapitelende.
Sonderausführungen und andere Beschichtungen auf Anfrage.

MEGA-Drill-Composite-UDX

Vollhartmetall-Spiralbohrer
SCD271 (5xD), innere Kühlmittelzufuhr

Ausführung:

Bohrerdurchmesser: 6,00 - 12,00 mm
Schneidstoff: HC619
Schneidenanzahl: 2
Anzahl Führungsfasen: 3
Spitzenwinkel: 90°
Spiralwinkel: 35°

Anwendung:

Für alle CFK-Werkstoffe / Problemlöser bei labilen Spannsituationen oder dünnwandigen Bauteilen.

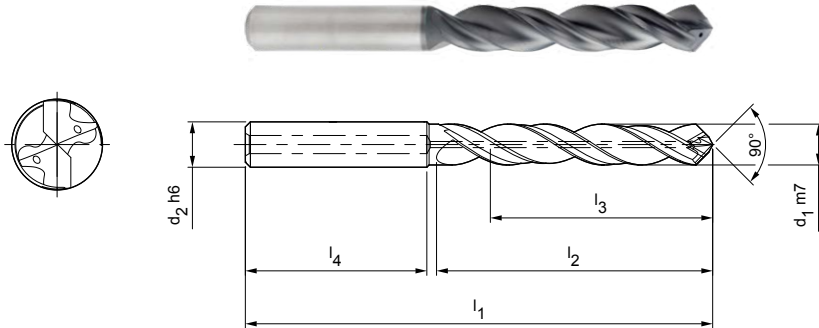

N	1.1	1.2	1.3	1.4	2.1	2.2	2.3	3.1	4.1	4.2	4.3	C	1.1	1.2	1.3	2.1	3.1	4.1	4.2	5.1	5.2	5.3	
								■				■		■	■	■							



Lagerhaltige Vorzugsbaureihe in Schaftform HA

Baumaße						Schaftform HA	
d ₁ m7	d ₂ h6	l ₁	l ₂	l ₃	l ₄	Spezifikation	Bestell-Nr.
6,00	6	82	44	35	36	SCD271-0600-2-2-090HA05-HC619	30402197
8,00	8	91	52	40	36	SCD271-0800-2-2-090HA05-HC619	30402219
10,00	10	103	60	45	40	SCD271-1000-2-2-090HA05-HC611	30402240

Konfigurierbare Merkmale



Durchmesser:
Durchmesser in Abstufungen
von 0,01 mm frei wählbar



Schaftform:
Schaftform: HB | HE

Spezifikation:

SCD271-[Durchmesser]-2-2-090[Schaftform]05-HC619

Beispiel:

SCD271-0431-2-2-090HE05-HC619

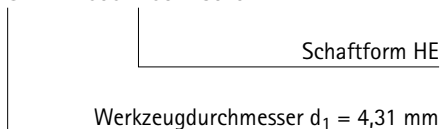

Abmessungen konfigurierbare Baureihe

d ₁ min.	d ₁ max.	d ₂ h6	l ₁	l ₂	l ₃	l ₄
6,00	6,00	6	82	44	35	36
6,01	8,00	8	91	52	40	36
8,01	10,00	10	103	60	45	40
10,01	12,00	12	118	70	52	45

Maßangaben in mm.

Schnittwertempfehlung siehe Kapitelende.

Sonderausführungen und andere Beschichtungen auf Anfrage.

MEGA-180°-Drill-Alu

Vollhartmetall-Spiralbohrer
SCD241 (3xD), innere Kühlmittelzufuhr

Ausführung:

Bohrerdurchmesser: 3,00 – 20,00 mm
Bohrungstoleranz: ≥ IT 9
Schneidstoff: HU630
Schneidenanzahl: 2
Anzahl Führungsfasen: 4
Spitzenwinkel: 180°
Spiralwinkel: 30°

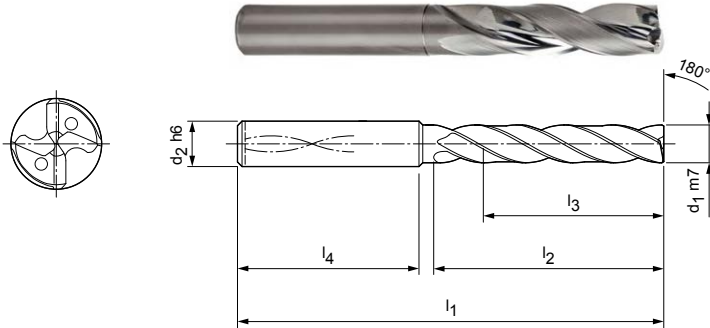

Lagerhaltige Vorzugsbaureihe in Schaftform HA

Baumaße						Schaftform HA	
d ₁ m7	d ₂ h6	l ₁	l ₂	l ₃	l ₄	Spezifikation	Bestell-Nr.
3,00	6	62	20	14	36	SCD241-0300-2-4-180HA03-HU630	30382883
3,70	6	62	20	14	36	SCD241-0370-2-4-180HA03-HU630	30382890
4,00	6	66	24	17	36	SCD241-0400-2-4-180HA03-HU630	30382893
4,20	6	66	24	17	36	SCD241-0420-2-4-180HA03-HU630	30382895
4,30	6	66	24	17	36	SCD241-0430-2-4-180HA03-HU630	30382896
4,60	6	66	24	17	36	SCD241-0460-2-4-180HA03-HU630	30382899
5,00	6	66	28	20	36	SCD241-0500-2-4-180HA03-HU630	30382904
5,50	6	66	28	20	36	SCD241-0550-2-4-180HA03-HU630	30382909
5,56	6	66	28	20	36	SCD241-0556-2-4-180HA03-HU630	30463897
6,00	6	66	28	20	36	SCD241-0600-2-4-180HA03-HU630	30382915
6,50	8	79	34	24	36	SCD241-0650-2-4-180HA03-HU630	30382920
6,70	8	79	34	24	36	SCD241-0670-2-4-180HA03-HU630	30382922
7,00	8	79	34	24	36	SCD241-0700-2-4-180HA03-HU630	30382925
7,20	8	79	41	29	36	SCD241-0720-2-4-180HA03-HU630	30382927
7,40	8	79	41	29	36	SCD241-0740-2-4-180HA03-HU630	30382929
7,50	8	79	41	29	36	SCD241-0750-2-4-180HA03-HU630	30382930
7,80	8	79	41	29	36	SCD241-0780-2-4-180HA03-HU630	30382933
8,00	8	79	41	29	36	SCD241-0800-2-4-180HA03-HU630	30382935
8,50	10	89	47	35	40	SCD241-0850-2-4-180HA03-HU630	30382940
8,90	10	89	47	35	40	SCD241-0890-2-4-180HA03-HU630	30382944
9,00	10	89	47	35	40	SCD241-0900-2-4-180HA03-HU630	30382945
9,20	10	89	47	35	40	SCD241-0920-2-4-180HA03-HU630	30382947
9,80	10	89	47	35	40	SCD241-0980-2-4-180HA03-HU630	30382953
10,00	10	89	47	35	40	SCD241-1000-2-4-180HA03-HU630	30382955
11,00	12	100	53	38	45	SCD241-1100-2-4-180HA03-HU630	30382965
12,00	12	100	53	38	45	SCD241-1200-2-4-180HA03-HU630	30382975
13,00	14	105	58	41	45	SCD241-1300-2-4-180HA03-HU630	30382978
14,50	16	113	63	43	48	SCD241-1450-2-4-180HA03-HU630	30382982
17,00	18	121	71	49	48	SCD241-1700-2-4-180HA03-HU630	30382990
18,50	20	129	77	53	50	SCD241-1850-2-4-180HA03-HU630	30382994

MEGA-180°-Drill-Alu | Vollhartmetall-Spiralbohrer SCD241 (3xD), innere Kühlmittelzufuhr

Konfigurierbare Merkmale



Durchmesser:
Durchmesser in Abstufungen
von 0,01 mm frei wählbar



Schaftform:
Schaftform: HB | HE

Spezifikation:

SCD241-[Durchmesser]-2-4-180[Schaftform]03-HU630

Beispiel:

SCD241-0431-2-4-180HE03-HU630

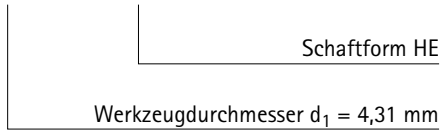

Abmessungen konfigurierbare Baureihe

d ₁ min.	d ₁ max.	d ₂ h6	l ₁	l ₂	l ₃	l ₄
3,00	3,70	6	62	20	14	36
3,71	4,70	6	66	24	17	36
4,71	6,00	6	66	28	20	36
6,01	6,80	8	79	34	24	36
6,81	8,00	8	79	41	29	36
8,01	10,00	10	89	47	35	40
10,01	12,00	12	100	53	38	45
12,0	14,00	14	105	58	41	45
14,01	16,00	16	113	63	43	48
16,01	18,00	18	121	71	49	48
18,01	20,00	20	129	77	53	50

Maßangaben in mm.

Schnittwertempfehlung siehe Kapitelende.

Sonderausführungen und andere Beschichtungen auf Anfrage.

MEGA-180°-Drill-Alu

Vollhartmetall-Spiralbohrer
SCD241 (5xD), innere Kühlmittelzufuhr

Ausführung:

Bohrerdurchmesser: 3,00 – 20,00 mm
Bohrungstoleranz: \geq IT 9
Schneidstoff: HU630
Schneidenanzahl: 2
Anzahl Führungsfasen: 4
Spitzenwinkel: 180°
Spiralwinkel: 30°

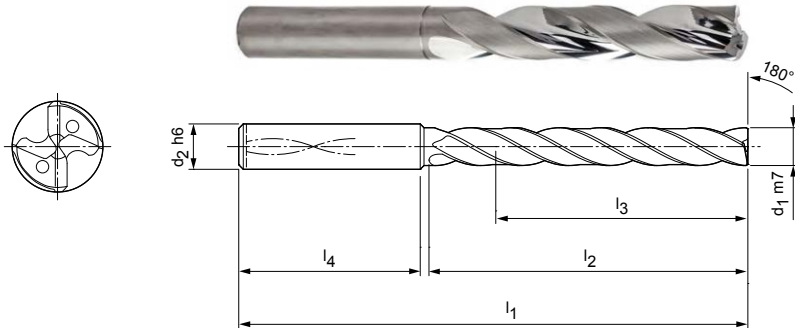

Lagerhaltige Vorzugsbaureihe in Schaftform HA

Baumaße						Schaftform HA	
d ₁ m7	d ₂ h6	l ₁	l ₂	l ₃	l ₄	Spezifikation	Bestell-Nr.
3,00	6	66	28	23	36	SCD241-0300-2-4-180HA05-HU630	30383000
3,50	6	66	28	23	36	SCD241-0350-2-4-180HA05-HU630	30383005
4,00	6	74	36	29	36	SCD241-0400-2-4-180HA05-HU630	30383010
4,10	6	74	36	29	36	SCD241-0410-2-4-180HA05-HU630	30383011
4,80	6	82	44	35	36	SCD241-0480-2-4-180HA05-HU630	30383019
5,00	6	82	44	35	36	SCD241-0500-2-4-180HA05-HU630	30383021
5,60	6	82	44	35	36	SCD241-0560-2-4-180HA05-HU630	30383028
6,00	6	82	44	35	36	SCD241-0600-2-4-180HA05-HU630	30383032
6,50	8	91	53	43	36	SCD241-0650-2-4-180HA05-HU630	30383037
7,00	8	91	53	43	36	SCD241-0700-2-4-180HA05-HU630	30383042
7,50	8	91	53	43	36	SCD241-0750-2-4-180HA05-HU630	30383047
8,00	8	91	53	43	36	SCD241-0800-2-4-180HA05-HU630	30383052
8,20	10	103	61	49	40	SCD241-0820-2-4-180HA05-HU630	30383054
8,50	10	103	61	49	40	SCD241-0850-2-4-180HA05-HU630	30383057
9,00	10	103	61	49	40	SCD241-0900-2-4-180HA05-HU630	30383062
9,30	10	103	61	49	40	SCD241-0930-2-4-180HA05-HU630	30383066
10,00	10	103	61	49	40	SCD241-1000-2-4-180HA05-HU630	30383073
12,00	12	116	69	54	45	SCD241-1200-2-4-180HA05-HU630	30383093
13,00	14	122	75	58	45	SCD241-1300-2-4-180HA05-HU630	30383096
14,00	14	122	75	58	45	SCD241-1400-2-4-180HA05-HU630	30383099
15,00	16	131	81	61	48	SCD241-1500-2-4-180HA05-HU630	30383102
15,70	16	131	81	61	48	SCD241-1570-2-4-180HA05-HU630	31237410
20,00	20	151	99	75	50	SCD241-2000-2-4-180HA05-HU630	30383117

MEGA-180°-Drill-Alu | Vollhartmetall-Spiralbohrer SCD241 (5xD), innere Kühlmittelzufuhr

Konfigurierbare Merkmale



Durchmesser:
Durchmesser in Abstufungen
von 0,01 mm frei wählbar



Schaftform:
Schaftform: HB | HE

Spezifikation:

SCD241-[Durchmesser]-2-4-180[Schaftform]05-HU630

Abmessungen konfigurierbare Baureihe

d ₁ min.	d ₁ max.	d ₂ h6	l ₁	l ₂	l ₃	l ₄
3,00	3,70	6	66	28	23	36
3,71	4,70	6	74	36	29	36
4,71	6,00	6	82	44	35	36
6,01	8,00	8	91	53	43	36
8,01	10,00	10	103	61	49	40
10,01	12,00	12	116	69	54	45
12,01	14,00	14	122	75	58	45
14,01	16,00	16	131	81	61	48
16,01	18,00	18	141	91	69	48
18,01	20,00	20	151	99	75	50

Beispiel:

SCD241-0431-2-4-180HE05-HU630

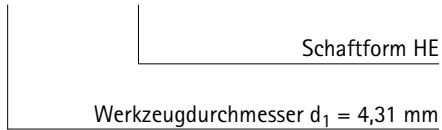

Maßangaben in mm.

Schnittwertempfehlung siehe Kapitelende.

Sonderausführungen und andere Beschichtungen auf Anfrage.

ECU-G-Drill

Vollhartmetallbohrer, geradegenutet
SCD211 (5xD), innere Kühlmittelzufuhr

Ausführung:

Bohrerdurchmesser: 4,80 – 7,50 mm
Bohrungstoleranz: \geq IT 9
Schneidstoff: HU610
Schneidenanzahl: 2
Anzahl Führungsfasen: 4
Spitzenwinkel: 130°

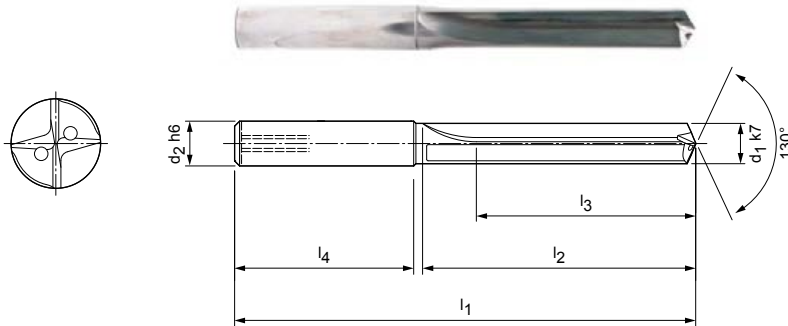

Lagerhaltige Vorzugsbaureihe in Schaftform HA

Baumaße						Schaftform HA	
d_1 k7	d_2 h6	l_1	l_2	l_3	l_4	Spezifikation	Bestell-Nr.
4,80	6	82	44	35	36	SCD211-0480-2-4-130HA05-HU610	30392622
5,50	6	82	44	35	36	SCD211-0550-2-4-130HA05-HU610	30392630
5,70	6	82	44	35	36	SCD211-0570-2-4-130HA05-HU610	30392632
5,80	6	82	44	35	36	SCD211-0580-2-4-130HA05-HU610	30392633
6,80	8	91	53	43	36	SCD211-0680-2-4-130HA05-HU610	30392643
7,40	8	91	53	43	36	SCD211-0740-2-4-130HA05-HU610	30392649
7,50	8	91	53	43	36	SCD211-0750-2-4-130HA05-HU610	30392650

Konfigurierbare Merkmale



Schaftform:
Schaftform: HB | HE



Spezifikation:

SCD211-0430-2-4-130[Schaftform]05-HU610

Beispiel:

SCD211-0430-3-3-140HE05-HU610

Schaftform HE

Maßangaben in mm.

Schnittwertempfehlung siehe Kapitelende.

Sonderausführungen und andere Beschichtungen auf Anfrage.

ECU-G-Drill

Vollhartmetallbohrer, geradegenutet
SCD211 (8xD), innere Kühlmittelzufuhr

Ausführung:

Bohrerdurchmesser: 5,80 – 11,60 mm
Bohrungstoleranz: \geq IT 9
Schneidstoff: HU610
Schneidenanzahl: 2
Anzahl Führungsfasen: 4
Spitzenwinkel: 130°

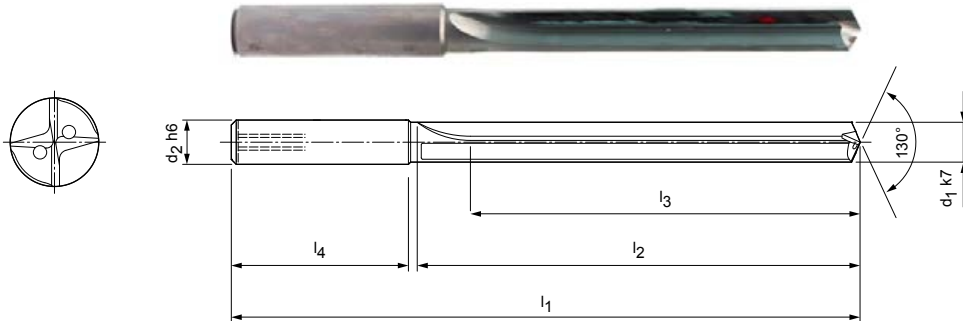

Lagerhaltige Vorzugsbaureihe in Schaftform HA

Baumaße						Schaftform HA	
d ₁ k7	d ₂ h6	l ₁	l ₂	l ₃	l ₄	Spezifikation	Bestell-Nr.
5,80	6	95	57	48	36	SCD211-0580-2-4-130HA08-HU610	30392739
11,60	12	162	114	96	45	SCD211-1160-2-4-130HA08-HU610	30392797

Konfigurierbare Merkmale



Schaftform:
Schaftform: HB | HE



Spezifikation:

SCD211-0430-2-4-130[Schaftform]08-HU610

Beispiel:

SCD211-0430-3-3-140HE08-HU610

Schaftform HE

Maßangaben in mm.

Schnittwertempfehlung siehe Kapitelende.

Sonderausführungen und andere Beschichtungen auf Anfrage.

Schnittwertempfehlung für Vollhartmetallbohrer

Vorschub und Schnittgeschwindigkeit

Tritan-Drill-Uni-Plus | SCD631

MZG*		Werkstoff	Festigkeit/Härte [N/mm ²] [HRC]	
P	P1	P1.1 Bau-, Automaten-, Einsatz- und Vergütungsstähle, unlegiert	< 700	
		P1.2 Bau-, Automaten-, Einsatz- und Vergütungsstähle, unlegiert	< 1.200	
	P2	P2.1 Nitrier-, Einsatz- und Vergütungsstähle, legiert	< 900	
		P2.2 Nitrier-, Einsatz- und Vergütungsstähle, legiert	< 1.400	
	P3	P3.1 Werkzeug-, Wälzlager-, Feder- und Schnellarbeitsstähle**	< 800	
		P3.2 Werkzeug-, Wälzlager-, Feder- und Schnellarbeitsstähle**	< 1.000	
		P3.3 Werkzeug-, Wälzlager-, Feder- und Schnellarbeitsstähle**	< 1.500	
	P5	P5.1 Stahlguss		
M	M1	M1.1 Rostfreie Stähle, austenitisch	< 700	
		M1.2 Rostfreie Stähle, ferritisch/austenitisch (Duplex)	< 1.000	
K	K1	K1.1 Gusseisen mit Lamellengraphit (Grauguss), GJL	< 300	
		K2.1 Gusseisen mit Kugelgraphit, GJS	< 500	
		K2.2 Gusseisen mit Kugelgraphit, GJS	≤ 800	
	K2	K2.3 Gusseisen mit Kugelgraphit, GJS	> 800	
		K3	K3.1 Gusseisen mit Vermiculargraphit, GJV; Temperguss, GJM	< 500
			K3.2 Gusseisen mit Vermiculargraphit, GJV; Temperguss, GJM	> 500
N	N1	N1.1 Aluminium, unlegiert und legiert < 3 % Si		
		N1.2 Aluminium, legiert ≤ 7 % Si		
		N1.3 Aluminium, legiert > 7-12 % Si		
		N1.4 Aluminium, legiert > 12 % Si		
	N2	N2.1 Kupfer, unlegiert und niedriglegiert	< 300	
		N2.2 Kupfer, legiert	> 300	
		N2.3 Messing, Bronze, Rotguss	< 1.200	

MEGA-Speed-Drill-Uni | SCD221

MZG*		Werkstoff	Festigkeit/Härte [N/mm ²] [HRC]	
P	P1	P1.1 Bau-, Automaten-, Einsatz- und Vergütungsstähle, unlegiert	< 700	
		P1.2 Bau-, Automaten-, Einsatz- und Vergütungsstähle, unlegiert	< 1.200	
	P2	P2.1 Nitrier-, Einsatz- und Vergütungsstähle, legiert	< 900	
		P2.2 Nitrier-, Einsatz- und Vergütungsstähle, legiert	< 1.400	
	P3	P3.1 Werkzeug-, Wälzlager-, Feder- und Schnellarbeitsstähle**	< 800	
		P3.2 Werkzeug-, Wälzlager-, Feder- und Schnellarbeitsstähle**	< 1.000	
		P3.3 Werkzeug-, Wälzlager-, Feder- und Schnellarbeitsstähle**	< 1.500	
	P4	P4.1 Rostfreie Stähle, ferritisch und martensitisch		
	P5	P5.1 Stahlguss		
	P6	P6.1 Rostfreier Stahlguss, ferritisch und martensitisch		
K	K1	K1.1 Gusseisen mit Lamellengraphit (Grauguss), GJL	< 300	
		K2.1 Gusseisen mit Kugelgraphit, GJS	< 500	
		K2.2 Gusseisen mit Kugelgraphit, GJS	≤ 800	
	K2	K2.3 Gusseisen mit Kugelgraphit, GJS	> 800	
		K3	K3.1 Gusseisen mit Vermiculargraphit, GJV; Temperguss, GJM	< 500
			K3.2 Gusseisen mit Vermiculargraphit, GJV; Temperguss, GJM	> 500

* MAPAL Zerspanungsgruppen

** Wenn die Legierungsbestandteile Cr, Mo, Ni, V, W in Summe > 8 %, dann die nächst höhere MAPAL Zerspanungsgruppe wählen.

	Schnittgeschwindigkeit v_c [m/min]				Vorschub f [mm] bei Bohrerdurchmesser					
	Innenkühlung	Außenkühlung	MMS	Luft	4,00	5,50	7,50	10,50	14,50	20,00
	115	105	105		0,22	0,27	0,34	0,42	0,51	0,59
	105	85	85		0,27	0,34	0,42	0,53	0,64	0,74
	115	100	100		0,25	0,32	0,40	0,50	0,60	0,70
	80	70	70		0,21	0,26	0,32	0,40	0,48	0,55
	85	75	75		0,23	0,29	0,36	0,45	0,54	0,63
	70	65	65		0,19	0,24	0,30	0,37	0,44	0,51
	70	50	60		0,16	0,19	0,24	0,29	0,34	0,40
	115	100	100		0,25	0,32	0,40	0,50	0,60	0,70
	55	35	35		0,11	0,14	0,18	0,22	0,27	0,31
	140	100	100	100	0,31	0,41	0,53	0,68	0,84	0,98
	185	115	140	140	0,30	0,39	0,50	0,64	0,78	0,91
	115	85	85		0,27	0,35	0,44	0,55	0,67	0,78
	70	45	60		0,14	0,18	0,22	0,28	0,33	0,38
	105	90	90		0,29	0,37	0,47	0,59	0,72	0,84
	90	80	80		0,25	0,31	0,38	0,48	0,57	0,66
	345	230	290		0,22	0,27	0,34	0,42	0,51	0,59
	290	205	230		0,27	0,35	0,44	0,55	0,67	0,78
	255	175	205		0,27	0,35	0,44	0,55	0,67	0,78
	205	140	175		0,27	0,35	0,44	0,55	0,67	0,78
	140	105			0,20	0,26	0,33	0,41	0,50	0,58
230	185	185	140	0,31	0,41	0,53	0,68	0,84	0,98	

	Schnittgeschwindigkeit v_c [m/min]				Vorschub f [mm] bei Bohrerdurchmesser					
	Innenkühlung	Außenkühlung	MMS	Luft	3,00	4,50	6,50	9,50	14,00	20,00
	170	155	155		0,11	0,14	0,18	0,23	0,30	0,36
	155	130	130		0,14	0,18	0,22	0,29	0,37	0,45
	170	145	145		0,13	0,17	0,21	0,27	0,35	0,43
	120	100	100		0,11	0,14	0,17	0,22	0,28	0,34
	130	110	110		0,11	0,15	0,19	0,25	0,32	0,38
	115	100	95		0,10	0,14	0,17	0,22	0,28	0,35
	100	75	85		0,10	0,13	0,16	0,20	0,26	0,31
	100	75	85		0,08	0,10	0,13	0,16	0,21	0,25
	170	145	145		0,13	0,17	0,21	0,27	0,35	0,43
	100	75	85		0,08	0,10	0,13	0,16	0,21	0,25
	150	105	105	105	0,13	0,19	0,26	0,35	0,45	0,54
	200	125	150	150	0,13	0,18	0,25	0,33	0,42	0,50
	125	95	95		0,12	0,16	0,22	0,28	0,36	0,43
	75	50	65		0,09	0,12	0,15	0,19	0,24	0,28
	115	100	100		0,13	0,18	0,23	0,31	0,39	0,46
	100	90	90		0,11	0,15	0,19	0,25	0,31	0,36

Die angegebenen Schnittwerte sind Richtwerte.

Die für den jeweiligen Bearbeitungsfall optimalen Daten sollten im Versuch oder während der Bearbeitung ermittelt werden.

Schnittwertempfehlung für Vollhartmetallbohrer

Vorschub und Schnittgeschwindigkeit

ECU-Drill-Uni | SCD350, 351

MZG*	Werkstoff	Festigkeit/Härte [N/mm ²] [HRC]
P	P1.1 Bau-, Automaten-, Einsatz- und Vergütungsstähle, unlegiert	< 700
	P1.2 Bau-, Automaten-, Einsatz- und Vergütungsstähle, unlegiert	< 1.200
	P2.1 Nitrier-, Einsatz- und Vergütungsstähle, legiert	< 900
	P2.2 Nitrier-, Einsatz- und Vergütungsstähle, legiert	< 1.400
	P3.1 Werkzeug-, Wälzlager-, Feder- und Schnellarbeitsstähle**	< 800
	P3.2 Werkzeug-, Wälzlager-, Feder- und Schnellarbeitsstähle**	< 1.000
	P3.3 Werkzeug-, Wälzlager-, Feder- und Schnellarbeitsstähle**	< 1.500
	P5.1 Stahlguss	
M	M1.1 Rostfreie Stähle, austenitisch	< 700
	M1.2 Rostfreie Stähle, ferritisch/austenitisch (Duplex)	< 1.000
	M2.1 Rostfreier Stahlguss, austenitisch	< 700
	M3.1 Rostfreier Stahlguss, ferritisch/austenitisch (Duplex)	< 1.000
K	K2.1 Gusseisen mit Kugelgraphit, GJS	< 500
	K2.2 Gusseisen mit Kugelgraphit, GJS	≤ 800
	K2.3 Gusseisen mit Kugelgraphit, GJS	> 800

MEGA-Drill-Steel-Plus | SCD600, 601

MZG*	Werkstoff	Festigkeit/Härte [N/mm ²] [HRC]
P	P1.1 Bau-, Automaten-, Einsatz- und Vergütungsstähle, unlegiert	< 700
	P1.2 Bau-, Automaten-, Einsatz- und Vergütungsstähle, unlegiert	< 1.200
	P2.1 Nitrier-, Einsatz- und Vergütungsstähle, legiert	< 900
	P2.2 Nitrier-, Einsatz- und Vergütungsstähle, legiert	< 1.400
	P3.1 Werkzeug-, Wälzlager-, Feder- und Schnellarbeitsstähle**	< 800
	P3.2 Werkzeug-, Wälzlager-, Feder- und Schnellarbeitsstähle**	< 1.000
	P3.3 Werkzeug-, Wälzlager-, Feder- und Schnellarbeitsstähle**	< 1.500
	P4.1 Rostfreie Stähle, ferritisch und martensitisch	
	P5.1 Stahlguss	
	P6.1 Rostfreier Stahlguss, ferritisch und martensitisch	
K	K1.1 Gusseisen mit Lamellengraphit (Grauguss), GJL	< 300
	K2.1 Gusseisen mit Kugelgraphit, GJS	< 500
	K2.2 Gusseisen mit Kugelgraphit, GJS	≤ 800
	K2.3 Gusseisen mit Kugelgraphit, GJS	> 800
	K3.1 Gusseisen mit Vermiculargraphit, GJV; Temperguss, GJM	< 500
	K3.2 Gusseisen mit Vermiculargraphit, GJV; Temperguss, GJM	> 500
H	H1.1 Gehärteter Stahl/Stahlguss	< 44
	H1.2 Gehärteter Stahl/Stahlguss	< 55

* MAPAL Zerspanungsgruppen

** Wenn die Legierungsbestandteile Cr, Mo, Ni, V, W in Summe > 8 %, dann die nächst höhere MAPAL Zerspanungsgruppe wählen.

	Schnittgeschwindigkeit v_c [m/min]				Vorschub f [mm] bei Bohrerdurchmesser					
	Innenkühlung	Außenkühlung	MMS	Luft	1,00	1,82	3,31	6,03	10,99	20,00
	75	70	70		0,03	0,05	0,07	0,10	0,16	0,21
	70	55	55		0,04	0,06	0,08	0,13	0,20	0,27
	75	65	65		0,04	0,05	0,08	0,12	0,18	0,25
	55	45	45		0,04	0,05	0,07	0,10	0,15	0,20
	55	50	50		0,03	0,05	0,07	0,11	0,17	0,23
	45	40	40		0,03	0,04	0,06	0,09	0,14	0,18
	45	35	40		0,03	0,04	0,05	0,07	0,11	0,14
	75	65	65		0,04	0,05	0,08	0,12	0,18	0,25
	45	30	30		0,03	0,04	0,06	0,09	0,14	0,19
	45	25	25		0,02	0,03	0,05	0,08	0,12	0,16
	45	30	30		0,03	0,04	0,06	0,09	0,14	0,19
	45	25	25		0,02	0,03	0,05	0,08	0,12	0,16
	120	75	90	90	0,05	0,07	0,12	0,19	0,30	0,41
	75	55	55		0,04	0,07	0,11	0,17	0,26	0,35

	Schnittgeschwindigkeit v_c [m/min]				Vorschub f [mm] bei Bohrerdurchmesser					
	Innenkühlung	Außenkühlung	MMS	Luft	3,00	4,50	6,50	9,50	14,00	20,00
	110	100	100		0,10	0,13	0,17	0,22	0,28	0,33
	100	85	85		0,12	0,16	0,21	0,27	0,34	0,41
	110	95	95		0,11	0,15	0,20	0,26	0,33	0,38
	75	65	65		0,10	0,13	0,16	0,21	0,26	0,30
	85	70	70		0,10	0,14	0,18	0,23	0,29	0,35
	65	60	60		0,09	0,12	0,15	0,19	0,24	0,28
	65	50	55		0,07	0,09	0,12	0,15	0,19	0,22
	65	50	55		0,07	0,09	0,12	0,15	0,19	0,23
	110	95	95		0,11	0,15	0,20	0,26	0,33	0,38
	65	50	55		0,07	0,09	0,12	0,15	0,19	0,23
	120	85	85	85	0,13	0,19	0,26	0,35	0,45	0,54
	160	100	120	120	0,13	0,18	0,25	0,33	0,42	0,50
	100	75	75		0,12	0,16	0,22	0,28	0,36	0,43
	60	40	50		0,09	0,12	0,15	0,19	0,24	0,28
	90	80	80		0,13	0,18	0,23	0,31	0,39	0,46
	80	70	70		0,11	0,15	0,19	0,25	0,31	0,36
	90	90	90		0,09	0,12	0,15	0,19	0,24	0,28
	25	25	25		0,05	0,06	0,08	0,11	0,14	0,16

Die angegebenen Schnittwerte sind Richtwerte.

Die für den jeweiligen Bearbeitungsfall optimalen Daten sollten im Versuch oder während der Bearbeitung ermittelt werden.

Schnittwertempfehlung für Vollhartmetallbohrer

Vorschub und Schnittgeschwindigkeit

MEGA-Quadro-Drill-Plus | SCD610, 611

MZG*	Werkstoff	Festigkeit/Härte [N/mm ²] [HRC]
P	P1.1 Bau-, Automaten-, Einsatz- und Vergütungsstähle, unlegiert	< 700
	P1.2 Bau-, Automaten-, Einsatz- und Vergütungsstähle, unlegiert	< 1.200
	P2.1 Nitrier-, Einsatz- und Vergütungsstähle, legiert	< 900
	P2.2 Nitrier-, Einsatz- und Vergütungsstähle, legiert	< 1.400
	P3.1 Werkzeug-, Wälzlager-, Feder- und Schnellarbeitsstähle*	< 800
	P3.2 Werkzeug-, Wälzlager-, Feder- und Schnellarbeitsstähle*	< 1.000
	P3.3 Werkzeug-, Wälzlager-, Feder- und Schnellarbeitsstähle*	< 1.500
	P5.1 Stahlguss	
K	K1.1 Gusseisen mit Lamellengraphit (Grauguss), GJL	< 300
	K2.1 Gusseisen mit Kugelgraphit, GJS	< 500
	K2.2 Gusseisen mit Kugelgraphit, GJS	≤ 800
	K2.3 Gusseisen mit Kugelgraphit, GJS	> 800
	K3.1 Gusseisen mit Vermiculargraphit, GJV; Temperguss, GJM	< 500
	K3.2 Gusseisen mit Vermiculargraphit, GJV; Temperguss, GJM	> 500

MICRO-Drill-Steel | SCD371

MZG*	Werkstoff	Festigkeit/Härte [N/mm ²] [HRC]
P	P1.1 Bau-, Automaten-, Einsatz- und Vergütungsstähle, unlegiert	< 700
	P1.2 Bau-, Automaten-, Einsatz- und Vergütungsstähle, unlegiert	< 1.200
	P2.1 Nitrier-, Einsatz- und Vergütungsstähle, legiert	< 900
	P2.2 Nitrier-, Einsatz- und Vergütungsstähle, legiert	< 1.400
	P3.1 Werkzeug-, Wälzlager-, Feder- und Schnellarbeitsstähle*	< 800
	P3.2 Werkzeug-, Wälzlager-, Feder- und Schnellarbeitsstähle*	< 1.000
	P3.3 Werkzeug-, Wälzlager-, Feder- und Schnellarbeitsstähle*	< 1.500
	P5.1 Stahlguss	
M	M1.1 Rostfreie Stähle, austenitisch	< 700
	M1.2 Rostfreie Stähle, ferritisch/austenitisch (Duplex)	< 1000
K	K1.1 Gusseisen mit Lamellengraphit (Grauguss), GJL	< 300
	K2.1 Gusseisen mit Kugelgraphit, GJS	< 500
	K2.2 Gusseisen mit Kugelgraphit, GJS	≤ 800
	K2.3 Gusseisen mit Kugelgraphit, GJS	> 800
	K3.1 Gusseisen mit Vermiculargraphit, GJV; Temperguss, GJM	< 500
	K3.2 Gusseisen mit Vermiculargraphit, GJV; Temperguss, GJM	> 500

MEGA-Drill-Hardened | SCD141

MZG*	Werkstoff	Festigkeit/Härte [N/mm ²] [HRC]
H	H1.1 Gehärteter Stahl/Stahlguss	< 44
	H1.2 Gehärteter Stahl/Stahlguss	< 55
	H2.1 Gehärteter Stahl/Stahlguss	< 60
	H2.2 Gehärteter Stahl/Stahlguss	< 65
	H2.3 Gehärteter Stahl/Stahlguss	< 68

* MAPAL Zerspanungsgruppen

** Wenn die Legierungsbestandteile Cr, Mo, Ni, V, W in Summe > 8 %, dann die nächst höhere MAPAL Zerspanungsgruppe wählen.

	Schnittgeschwindigkeit v_c [m/min]				Vorschub f [mm] bei Bohrerdurchmesser					
	Innenkühlung	Außenkühlung	MMS	Luft	4,00	5,50	7,50	10,50	14,50	20,00
	110	100	100		0,10	0,13	0,17	0,22	0,28	0,33
	100	85	85		0,12	0,16	0,21	0,27	0,34	0,41
	110	95	95		0,11	0,15	0,20	0,26	0,33	0,38
	75	65	65		0,10	0,13	0,16	0,21	0,26	0,30
	85	70	70		0,10	0,14	0,18	0,23	0,29	0,35
	65	60	60		0,09	0,12	0,15	0,19	0,24	0,28
	65	50	55		0,07	0,09	0,12	0,15	0,19	0,22
	110	95	95		0,11	0,15	0,20	0,26	0,33	0,38
	130	95	95	95	0,13	0,19	0,26	0,35	0,45	0,54
	175	110	130	130	0,13	0,18	0,25	0,33	0,42	0,50
	110	85	85		0,12	0,16	0,22	0,28	0,36	0,43
	65	45	55		0,09	0,12	0,15	0,19	0,24	0,28
	100	90	90		0,13	0,18	0,23	0,31	0,39	0,46
	90	75	75		0,11	0,15	0,19	0,25	0,31	0,36

	Schnittgeschwindigkeit v_c [m/min]				Vorschub f [mm] bei Bohrerdurchmesser					
	Innenkühlung	Außenkühlung	MMS	Luft	4,00	5,50	7,50	10,50	14,50	20,00
	80	70	70		0,04	0,04	0,05	0,06	0,07	0,08
	70	60	60		0,04	0,05	0,06	0,07	0,08	0,10
	80	70	70		0,04	0,05	0,06	0,07	0,08	0,09
	55	50	50		0,04	0,05	0,05	0,06	0,07	0,08
	60	50	50		0,04	0,04	0,05	0,06	0,07	0,08
	50	45	45		0,04	0,04	0,04	0,05	0,06	0,07
	50	35	40		0,03	0,04	0,04	0,05	0,05	0,06
	80	70	70		0,04	0,05	0,06	0,07	0,08	0,09
	40	25	25		0,03	0,03	0,03	0,04	0,05	0,06
	95	70	70	70	0,03	0,04	0,05	0,06	0,08	0,11
	130	80	95	95	0,04	0,05	0,06	0,07	0,09	0,11
	80	60	60		0,04	0,05	0,05	0,07	0,08	0,10
	70	65	65		0,04	0,05	0,06	0,07	0,09	0,11
	65	55	55		0,04	0,05	0,06	0,07	0,08	0,09

	Schnittgeschwindigkeit v_c [m/min]				Vorschub f [mm] bei Bohrerdurchmesser					
	Innenkühlung	Außenkühlung	MMS	Luft	2,50	3,62	5,25	7,61	11,04	16,00
	80	80	80		0,07	0,09	0,11	0,02	0,19	0,20
	30	30	30		0,05	0,06	0,08	0,10	0,13	0,16
		30	30		0,04	0,05	0,07	0,09	0,11	0,13
		20	20		0,03	0,04	0,05	0,06	0,08	0,09
		15	15		0,03	0,04	0,05	0,06	0,08	0,09

Die angegebenen Schnittwerte sind Richtwerte.

Die für den jeweiligen Bearbeitungsfall optimalen Daten sollten im Versuch oder während der Bearbeitung ermittelt werden.

Schnittwertempfehlung für Vollhartmetallbohrer

Vorschub und Schnittgeschwindigkeit

Tritan-Drill-Steel | SCD661

MZG*	Werkstoff	Festigkeit/Härte [N/mm ²] [HRC]
P	P1.1 Bau-, Automaten-, Einsatz- und Vergütungsstähle, unlegiert	< 700
	P1.2 Bau-, Automaten-, Einsatz- und Vergütungsstähle, unlegiert	< 1.200
	P2.1 Nitrier-, Einsatz- und Vergütungsstähle, legiert	< 900
	P2.2 Nitrier-, Einsatz- und Vergütungsstähle, legiert	< 1.400
	P3.1 Werkzeug-, Wälzlager-, Feder- und Schnellarbeitsstähle**	< 800
	P3.2 Werkzeug-, Wälzlager-, Feder- und Schnellarbeitsstähle**	< 1.000
	P3.3 Werkzeug-, Wälzlager-, Feder- und Schnellarbeitsstähle**	< 1.500
	P5.1 Stahlguss	
M	M1.1 Rostfreie Stähle, austenitisch	< 700
	M1.2 Rostfreie Stähle, ferritisch/austenitisch (Duplex)	< 1.000
K	K1.1 Gusseisen mit Lamellengraphit (Grauguss), GJL	< 300
	K2.1 Gusseisen mit Kugelgraphit, GJS	< 500
	K2.2 Gusseisen mit Kugelgraphit, GJS	≤ 800
	K2.3 Gusseisen mit Kugelgraphit, GJS	> 800
	K3.1 Gusseisen mit Vermiculargraphit, GJV; Temperguss, GJM	< 500
	K3.2 Gusseisen mit Vermiculargraphit, GJV; Temperguss, GJM	> 500

MEGA-Speed-Drill-Steel | SCD621

MZG*	Werkstoff	Festigkeit/Härte [N/mm ²] [HRC]
P	P1.1 Bau-, Automaten-, Einsatz- und Vergütungsstähle, unlegiert	< 700
	P1.2 Bau-, Automaten-, Einsatz- und Vergütungsstähle, unlegiert	< 1.200
	P2.1 Nitrier-, Einsatz- und Vergütungsstähle, legiert	< 900
	P2.2 Nitrier-, Einsatz- und Vergütungsstähle, legiert	< 1.400
	P3.1 Werkzeug-, Wälzlager-, Feder- und Schnellarbeitsstähle**	< 800
	P3.2 Werkzeug-, Wälzlager-, Feder- und Schnellarbeitsstähle**	< 1.000
	P3.3 Werkzeug-, Wälzlager-, Feder- und Schnellarbeitsstähle**	< 1.500
	P4.1 Rostfreie Stähle, ferritisch und martensitisch	
P5.1 Stahlguss		
P6.1 Rostfreier Stahlguss, ferritisch und martensitisch		
M	M1.1 Rostfreie Stähle, austenitisch	< 700
	M1.2 Rostfreie Stähle, ferritisch/austenitisch (Duplex)	< 1.000
	M2.1 Rostfreier Stahlguss, austenitisch	< 700
	M3.1 Rostfreier Stahlguss, ferritisch/austenitisch (Duplex)	< 1.000
K	K1.1 Gusseisen mit Lamellengraphit (Grauguss), GJL	< 300
	K2.1 Gusseisen mit Kugelgraphit, GJS	< 500
	K2.2 Gusseisen mit Kugelgraphit, GJS	≤ 800
	K2.3 Gusseisen mit Kugelgraphit, GJS	> 800
	K3.1 Gusseisen mit Vermiculargraphit, GJV; Temperguss, GJM	< 500
	K3.2 Gusseisen mit Vermiculargraphit, GJV; Temperguss, GJM	> 500

* MAPAL Zerspanungsgruppen

** Wenn die Legierungsbestandteile Cr, Mo, Ni, V, W in Summe > 8 %, dann die nächst höhere MAPAL Zerspanungsgruppe wählen.

	Schnittgeschwindigkeit v_c [m/min]				Vorschub f [mm] bei Bohrerdurchmesser					
	Innenkühlung	Außenkühlung	MMS	Luft	4,00	5,50	7,50	10,50	14,50	20,00
	115	105	105		0,24	0,30	0,37	0,46	0,56	0,65
	105	85	85		0,30	0,37	0,46	0,58	0,70	0,81
	115	100	100		0,28	0,35	0,44	0,55	0,66	0,77
	80	70	70		0,24	0,29	0,36	0,44	0,53	0,61
	85	75	75		0,25	0,31	0,39	0,49	0,60	0,69
	70	65	65		0,21	0,26	0,33	0,41	0,49	0,56
	70	50	60		0,18	0,21	0,26	0,32	0,38	0,43
	115	100	100		0,28	0,35	0,44	0,55	0,66	0,77
	55	35	35		0,11	0,14	0,18	0,22	0,27	0,31
	140	100	100	100	0,34	0,45	0,58	0,75	0,92	1,08
	185	115	140	140	0,34	0,43	0,55	0,70	0,85	1,00
	115	85	85		0,30	0,38	0,48	0,61	0,74	0,86
	70	45	60		0,16	0,20	0,25	0,31	0,38	0,44
	105	90	90		0,32	0,41	0,52	0,65	0,79	0,92
	90	80	80		0,27	0,34	0,42	0,52	0,63	0,73

	Schnittgeschwindigkeit v_c [m/min]				Vorschub f [mm] bei Bohrerdurchmesser					
	Innenkühlung	Außenkühlung	MMS	Luft	3,00	4,50	6,50	9,50	14,00	20,00
	170	155	155		0,13	0,17	0,22	0,29	0,36	0,43
	155	130	130		0,16	0,21	0,28	0,36	0,45	0,54
	170	145	145		0,15	0,20	0,26	0,34	0,43	0,51
	120	100	100		0,13	0,17	0,21	0,27	0,34	0,40
	130	110	110		0,13	0,18	0,23	0,30	0,39	0,46
	100	95	95		0,12	0,15	0,20	0,25	0,32	0,37
	100	75	85		0,10	0,12	0,16	0,20	0,25	0,29
	100	75	85		0,09	0,12	0,16	0,20	0,25	0,30
	170	145	145		0,15	0,20	0,26	0,34	0,43	0,51
	100	75	85		0,09	0,12	0,16	0,20	0,25	0,30
	65	40	40		0,07	0,09	0,12	0,15	0,19	0,23
	60	35	35		0,06	0,08	0,10	0,13	0,17	0,20
	65	40	40		0,07	0,09	0,12	0,15	0,19	0,23
	60	35	35		0,06	0,08	0,10	0,13	0,17	0,20
	150	105	105	105	0,14	0,21	0,28	0,38	0,49	0,59
	200	125	150	150	0,14	0,20	0,27	0,36	0,46	0,54
	125	95	95		0,13	0,18	0,24	0,31	0,39	0,47
	75	50	65		0,09	0,12	0,15	0,19	0,24	0,28
	115	100	100		0,14	0,19	0,25	0,33	0,42	0,50
	100	90	90		0,12	0,16	0,21	0,27	0,34	0,40

Die angegebenen Schnittwerte sind Richtwerte.

Die für den jeweiligen Bearbeitungsfall optimalen Daten sollten im Versuch oder während der Bearbeitung ermittelt werden.

Schnittwertempfehlung für Vollhartmetallbohrer

Vorschub und Schnittgeschwindigkeit

MEGA-180°-Drill | SCD231

MZG*	Werkstoff	Festigkeit/Härte [N/mm ²] [HRC]
P	P1.1 Bau-, Automaten-, Einsatz- und Vergütungsstähle, unlegiert	< 700
	P1.2 Bau-, Automaten-, Einsatz- und Vergütungsstähle, unlegiert	< 1.200
	P2.1 Nitrier-, Einsatz- und Vergütungsstähle, legiert	< 900
	P2.2 Nitrier-, Einsatz- und Vergütungsstähle, legiert	< 1.400
	P3.1 Werkzeug-, Wälzlager-, Feder- und Schnellarbeitsstähle**	< 800
	P3.2 Werkzeug-, Wälzlager-, Feder- und Schnellarbeitsstähle**	< 1.000
	P3.3 Werkzeug-, Wälzlager-, Feder- und Schnellarbeitsstähle**	< 1.500
	P5.1 Stahlguss	
K	K1.1 Gusseisen mit Lamellengraphit (Grauguss), GJL	< 300
	K2.1 Gusseisen mit Kugelgraphit, GJS	< 500
	K2.2 Gusseisen mit Kugelgraphit, GJS	≤ 800
	K2.3 Gusseisen mit Kugelgraphit, GJS	> 800
	K3.1 Gusseisen mit Vermiculargraphit, GJV; Temperguss, GJM	< 500
	K3.2 Gusseisen mit Vermiculargraphit, GJV; Temperguss, GJM	> 500

ECU-Drill-Steel | SCD360, 361

MZG*	Werkstoff	Festigkeit/Härte [N/mm ²] [HRC]
P	P1.1 Bau-, Automaten-, Einsatz- und Vergütungsstähle, unlegiert	< 700
	P1.2 Bau-, Automaten-, Einsatz- und Vergütungsstähle, unlegiert	< 1.200
	P2.1 Nitrier-, Einsatz- und Vergütungsstähle, legiert	< 900
	P2.2 Nitrier-, Einsatz- und Vergütungsstähle, legiert	< 1.400
	P3.1 Werkzeug-, Wälzlager-, Feder- und Schnellarbeitsstähle**	< 800
	P3.2 Werkzeug-, Wälzlager-, Feder- und Schnellarbeitsstähle**	< 1.000
	P3.3 Werkzeug-, Wälzlager-, Feder- und Schnellarbeitsstähle**	< 1.500
	P4.1 Rostfreie Stähle, ferritisch und martensitisch	
	P5.1 Stahlguss	
	P6.1 Rostfreier Stahlguss, ferritisch und martensitisch	
K	K1.1 Gusseisen mit Lamellengraphit (Grauguss), GJL	< 300
	K2.1 Gusseisen mit Kugelgraphit, GJS	< 500
	K2.2 Gusseisen mit Kugelgraphit, GJS	≤ 800
	K2.3 Gusseisen mit Kugelgraphit, GJS	> 800
	K3.1 Gusseisen mit Vermiculargraphit, GJV; Temperguss, GJM	< 500
	K3.2 Gusseisen mit Vermiculargraphit, GJV; Temperguss, GJM	> 500

* MAPAL Zerspanungsgruppen

** Wenn die Legierungsbestandteile Cr, Mo, Ni, V, W in Summe > 8 %, dann die nächst höhere MAPAL Zerspanungsgruppe wählen.

	Schnittgeschwindigkeit v_c [m/min]				Vorschub f [mm] bei Bohrerdurchmesser					
	Innenkühlung	Außenkühlung	MMS	Luft	3,00	4,50	6,50	9,50	14,00	20,00
	80	70	70		0,07	0,09	0,12	0,16	0,20	0,24
	70	60	60		0,09	0,12	0,15	0,20	0,25	0,30
	80	70	70		0,08	0,11	0,14	0,19	0,24	0,28
	55	50	50		0,07	0,09	0,12	0,15	0,19	0,22
	60	50	50		0,07	0,10	0,13	0,17	0,21	0,25
	50	45	45		0,06	0,08	0,11	0,14	0,17	0,21
	50	35	40		0,05	0,07	0,09	0,11	0,14	0,16
	80	70	70		0,08	0,11	0,14	0,19	0,24	0,28
	95	70	70	70	0,09	0,14	0,19	0,25	0,33	0,39
	130	80	95	95	0,10	0,13	0,18	0,24	0,30	0,36
	80	60	60		0,09	0,12	0,16	0,21	0,26	0,31
	50	30	40		0,06	0,08	0,11	0,14	0,17	0,21
	70	65	65		0,09	0,13	0,17	0,22	0,28	0,33
	65	55	55		0,08	0,11	0,14	0,18	0,22	0,26

	Schnittgeschwindigkeit v_c [m/min]				Vorschub f [mm] bei Bohrerdurchmesser					
	Innenkühlung	Außenkühlung	MMS	Luft	1,00	1,82	3,31	6,03	10,99	20,00
	75	70	70		0,04	0,06	0,08	0,13	0,20	0,27
	70	55	55		0,05	0,07	0,11	0,16	0,24	0,33
	75	65	65		0,05	0,07	0,10	0,15	0,23	0,31
	55	45	45		0,05	0,06	0,09	0,13	0,18	0,25
	55	50	50		0,04	0,06	0,09	0,14	0,21	0,28
	45	40	40		0,04	0,05	0,08	0,12	0,17	0,23
	45	35	40		0,04	0,05	0,06	0,09	0,13	0,18
	45	35	40		0,03	0,04	0,06	0,09	0,14	0,19
	75	65	65		0,05	0,07	0,10	0,15	0,23	0,31
	45	35	40		0,03	0,04	0,06	0,09	0,14	0,19
	80	60	60	60	0,04	0,07	0,12	0,20	0,32	0,44
	110	70	80	80	0,05	0,07	0,12	0,19	0,30	0,41
	70	50	50		0,04	0,07	0,11	0,17	0,26	0,35
	40	25	35		0,04	0,05	0,08	0,12	0,17	0,23
	60	55	55		0,05	0,07	0,11	0,18	0,27	0,38
	55	50	50		0,05	0,07	0,10	0,15	0,22	0,30

Die angegebenen Schnittwerte sind Richtwerte.

Die für den jeweiligen Bearbeitungsfall optimalen Daten sollten im Versuch oder während der Bearbeitung ermittelt werden.

Schnittwertempfehlung für Vollhartmetallbohrer

Vorschub und Schnittgeschwindigkeit

MEGA-Drill-Inox | SCD120, 121

MZG*	Werkstoff	Festigkeit/Härte [N/mm ²] [HRC]
P	P1.1 Bau-, Automaten-, Einsatz- und Vergütungsstähle, unlegiert	< 700
	P1.2 Bau-, Automaten-, Einsatz- und Vergütungsstähle, unlegiert	< 1.200
	P2.1 Nitrier-, Einsatz- und Vergütungsstähle, legiert	< 900
	P2.2 Nitrier-, Einsatz- und Vergütungsstähle, legiert	< 1.400
	P3.1 Werkzeug-, Wälzlager-, Feder- und Schnellarbeitsstähle**	< 800
	P3.2 Werkzeug-, Wälzlager-, Feder- und Schnellarbeitsstähle**	< 1.000
	P3.3 Werkzeug-, Wälzlager-, Feder- und Schnellarbeitsstähle**	< 1.500
	P4.1 Rostfreie Stähle, ferritisch und martensitisch	
	P5.1 Stahlguss	
	P6.1 Rostfreier Stahlguss, ferritisch und martensitisch	
M	M1.1 Rostfreie Stähle, austenitisch	< 700
	M1.2 Rostfreie Stähle, ferritisch/austenitisch (Duplex)	< 1.000
	M2.1 Rostfreier Stahlguss, austenitisch	< 700
	M3.1 Rostfreier Stahlguss, ferritisch/austenitisch (Duplex)	< 1.000
K	K1.1 Gusseisen mit Lamellengraphit (Grauguss), GJL	< 300
	K2.1 Gusseisen mit Kugelgraphit, GJS	< 500
	K2.2 Gusseisen mit Kugelgraphit, GJS	≤ 800
	K2.3 Gusseisen mit Kugelgraphit, GJS	> 800
	K3.1 Gusseisen mit Vermiculargraphit, GJV; Temperguss, GJM	< 500
	K3.2 Gusseisen mit Vermiculargraphit, GJV; Temperguss, GJM	> 500
N	N2.1 Kupfer, unlegiert und niedriglegiert	< 300
	N2.2 Kupfer, legiert	> 300
	N2.3 Messing, Bronze, Rotguss	< 1.200

MEGA-Speed-Drill-Inox | SCD411

MZG*	Werkstoff	Festigkeit/Härte [N/mm ²] [HRC]
P	P1.1 Bau-, Automaten-, Einsatz- und Vergütungsstähle, unlegiert	< 700
	P1.2 Bau-, Automaten-, Einsatz- und Vergütungsstähle, unlegiert	< 1.200
	P2.1 Nitrier-, Einsatz- und Vergütungsstähle, legiert	< 900
	P2.2 Nitrier-, Einsatz- und Vergütungsstähle, legiert	< 1.400
	P3.1 Werkzeug-, Wälzlager-, Feder- und Schnellarbeitsstähle**	< 800
	P3.2 Werkzeug-, Wälzlager-, Feder- und Schnellarbeitsstähle**	< 1.000
	P3.3 Werkzeug-, Wälzlager-, Feder- und Schnellarbeitsstähle**	< 1.500
	P4.1 Rostfreie Stähle, ferritisch und martensitisch	
	P5.1 Stahlguss	
	P6.1 Rostfreier Stahlguss, ferritisch und martensitisch	
M	M1.1 Rostfreie Stähle, austenitisch	< 700
	M1.2 Rostfreie Stähle, ferritisch/austenitisch (Duplex)	< 1.000
	M2.1 Rostfreier Stahlguss, austenitisch	< 700
	M3.1 Rostfreier Stahlguss, ferritisch/austenitisch (Duplex)	< 1.000
S	S1.1 Titan, Titanlegierungen	< 400
	S2.1 Titan, Titanlegierungen	< 1.200
	S2.2 Titan, Titanlegierungen	> 1.200
	S3.1 Nickel, unlegiert und legiert	< 900
	S3.2 Nickel, unlegiert und legiert	> 900
	S4.1 Hochwarmfeste Superlegierung, Ni-, Co-, und Fe-basiert	
	S5.1 Wolfram- und Molybdänlegierungen	

* MAPAL Zerspanungsgruppen

** Wenn die Legierungsbestandteile Cr, Mo, Ni, V, W in Summe > 8 %, dann die nächst höhere MAPAL Zerspanungsgruppe wählen.

	Schnittgeschwindigkeit v_c [m/min]				Vorschub f [mm] bei Bohrerdurchmesser					
	Innenkühlung	Außenkühlung	MMS	Luft	3,00	4,50	6,50	9,50	14,00	20,00
	100	90	90		0,07	0,09	0,12	0,16	0,20	0,24
	90	75	75		0,09	0,12	0,15	0,20	0,25	0,30
	100	85	85		0,08	0,11	0,14	0,19	0,24	0,28
	70	60	60		0,07	0,09	0,12	0,15	0,19	0,22
	75	65	65		0,07	0,10	0,13	0,17	0,21	0,25
	60	55	55		0,06	0,08	0,11	0,14	0,17	0,21
	60	45	50		0,05	0,07	0,09	0,11	0,14	0,16
	60	45	50		0,05	0,07	0,09	0,11	0,14	0,17
	100	85	85		0,08	0,11	0,14	0,19	0,24	0,28
	60	45	50		0,05	0,07	0,09	0,11	0,14	0,17
	55	35	35		0,06	0,08	0,11	0,14	0,18	0,21
	50	30	30		0,05	0,07	0,09	0,12	0,15	0,18
	55	35	35		0,06	0,08	0,11	0,14	0,18	0,21
	50	30	30		0,05	0,07	0,09	0,12	0,15	0,18
	120	85	85	85	0,12	0,17	0,24	0,32	0,41	0,49
	160	100	120	120	0,12	0,17	0,22	0,30	0,38	0,45
	100	75	75		0,11	0,15	0,20	0,26	0,33	0,39
	60	40	50		0,08	0,10	0,13	0,17	0,22	0,26
	90	80	80		0,12	0,16	0,21	0,28	0,35	0,42
	80	70	70		0,10	0,13	0,17	0,22	0,28	0,33
	140	100			0,09	0,12	0,15	0,20	0,25	0,30
	120	90			0,11	0,15	0,20	0,26	0,33	0,39
	200	160	160	120	0,12	0,17	0,24	0,32	0,41	0,49

	Schnittgeschwindigkeit v_c [m/min]				Vorschub f [mm] bei Bohrerdurchmesser					
	Innenkühlung	Außenkühlung	MMS	Luft	3,00	4,50	6,50	9,50	14,00	20,00
	150	135	135		0,09	0,12	0,15	0,20	0,25	0,30
	135	115	115		0,11	0,15	0,19	0,25	0,31	0,37
	150	130	130		0,10	0,14	0,18	0,23	0,30	0,35
	105	90	90		0,09	0,12	0,15	0,19	0,24	0,28
	115	100	100		0,09	0,12	0,16	0,21	0,27	0,32
	90	85	85		0,08	0,10	0,13	0,17	0,22	0,26
	90	70	75		0,07	0,09	0,11	0,14	0,17	0,20
	70	55	60		0,06	0,08	0,11	0,14	0,18	0,21
	150	130	130		0,10	0,14	0,18	0,23	0,30	0,35
	70	55	60		0,06	0,08	0,11	0,14	0,18	0,21
	80	50	50		0,08	0,10	0,13	0,17	0,22	0,26
	75	45	45		0,07	0,09	0,11	0,15	0,19	0,22
	80	50	50		0,08	0,10	0,13	0,17	0,22	0,26
	75	45	45		0,07	0,09	0,11	0,15	0,19	0,22
					0,07	0,10	0,13	0,17	0,21	0,25
	35	25			0,06	0,08	0,11	0,14	0,18	0,21
	30	20			0,05	0,07	0,09	0,12	0,15	0,18
	25	20			0,04	0,06	0,07	0,10	0,12	0,14
	20	10			0,05	0,07	0,09	0,12	0,15	0,18
	20	10			0,04	0,06	0,07	0,10	0,12	0,14
	20	10			0,04	0,06	0,07	0,10	0,12	0,14

Die angegebenen Schnittwerte sind Richtwerte.

Die für den jeweiligen Bearbeitungsfall optimalen Daten sollten im Versuch oder während der Bearbeitung ermittelt werden.

Schnittwertempfehlung für Vollhartmetallbohrer

Vorschub und Schnittgeschwindigkeit

MEGA-Speed-Drill-Iron | SCD421

MZG*	Werkstoff		Festigkeit/Härte [N/mm ²] [HRC]
K	K1	K1.1 Gusseisen mit Lamellengraphit (Grauguss), GJL	< 300
		K2.1 Gusseisen mit Kugelgraphit, GJS	< 500
	K2	K2.2 Gusseisen mit Kugelgraphit, GJS	≤ 800
		K2.3 Gusseisen mit Kugelgraphit, GJS	> 800
	K3	K3.1 Gusseisen mit Vermiculargraphit, GJV; Temperguss, GJM	< 500
		K3.2 Gusseisen mit Vermiculargraphit, GJV; Temperguss, GJM	> 500

MEGA-Drill-Alu | SCD131

MZG*	Werkstoff		Festigkeit/Härte [N/mm ²] [HRC]
N	N1	N1.1 Aluminium, unlegiert und legiert < 3 % Si	
		N1.2 Aluminium, legiert ≤ 7 % Si	
		N1.3 Aluminium, legiert > 7-12 % Si	
		N1.4 Aluminium, legiert > 12 % Si	
	N2	N2.1 Kupfer, unlegiert und niedriglegiert	< 300
		N2.2 Kupfer, legiert	> 300
N2.3 Messing, Bronze, Rotguss		< 1.200	

MEGA-Drill-Composite-MD | SCD250

MZG*	Werkstoff		Festigkeit/Härte [N/mm ²] [HRC]	
N	N3	N3.1 Graphit, > 8 µm		
		N3.2 Graphit, ≤ 8 µm		
C	C1	C1.1 Kunststoffmatrix, Aramidfaserverstärkt (AFK)		
		C1.2 Kunststoffmatrix (duroplastisch), CFK/GFK		
		C1.3 Kunststoffmatrix (thermoplastisch), CFK/GFK		
	C2	C2.1 Kohlenstoffmatrix, Kohlenstofffaserverstärkt (CFC)		
		C3	C3.1 Metallmatrix (MMC)	
			C4.1 Sandwichkonstruktion, Wabenkern (Honeycomb)	
C4	C4.2 Sandwichkonstruktion, Schaumkern			

MEGA-Drill-Composite-UDX | SCD270, 271

MZG*	Werkstoff		Festigkeit/Härte [N/mm ²] [HRC]
C	C1	C1.1 Kunststoffmatrix, Aramidfaserverstärkt (AFK)	
		C1.2 Kunststoffmatrix (duroplastisch), CFK/GFK	
		C1.3 Kunststoffmatrix (thermoplastisch), CFK/GFK	
	C2	C2.1 Kohlenstoffmatrix, Kohlenstofffaserverstärkt (CFC)	

* MAPAL Zerspanungsgruppen

	Schnittgeschwindigkeit v_c [m/min]				Vorschub f [mm] bei Bohrerdurchmesser					
	Innenkühlung	Außenkühlung	MMS	Luft	3,00	4,50	6,50	9,50	14,00	20,00
	170	120	120	120	0,15	0,21	0,29	0,40	0,51	0,61
	225	140	170	170	0,15	0,21	0,28	0,37	0,48	0,57
	140	105	105		0,14	0,19	0,25	0,32	0,41	0,49
	85	55	70		0,10	0,13	0,17	0,22	0,27	0,32
	125	110	110		0,15	0,20	0,26	0,35	0,44	0,52
	110	100	100		0,13	0,17	0,22	0,28	0,35	0,41

	Schnittgeschwindigkeit v_c [m/min]				Vorschub f [mm] bei Bohrerdurchmesser					
	Innenkühlung	Außenkühlung	MMS	Luft	3,00	4,50	6,50	9,50	14,00	20,00
	300	200	250		0,09	0,12	0,15	0,20	0,25	0,30
	250	180	200		0,11	0,15	0,20	0,26	0,33	0,39
	220	150	180		0,11	0,15	0,20	0,26	0,33	0,39
	180	120	150		0,11	0,15	0,20	0,26	0,33	0,39
	140	100			0,09	0,12	0,15	0,20	0,25	0,30
	120	90			0,11	0,15	0,20	0,26	0,33	0,39
	200	160	160	120	0,09	0,14	0,19	0,25	0,33	0,39

	Schnittgeschwindigkeit v_c [m/min]				Vorschub f [mm] bei Bohrerdurchmesser					
	Innenkühlung	Außenkühlung	MMS	Luft	3,00	4,00	5,50	7,50	10,00	12,00
				200	0,07	0,09	0,11	0,14	0,16	0,18
				200	0,07	0,09	0,11	0,14	0,16	0,18
				90	0,04	0,04	0,05	0,06	0,07	0,08
				75	0,04	0,04	0,05	0,06	0,07	0,08
				75	0,04	0,04	0,05	0,06	0,07	0,08
				400	0,04	0,04	0,05	0,06	0,07	0,08
				400	0,04	0,04	0,05	0,06	0,07	0,08

	Schnittgeschwindigkeit v_c [m/min]				Vorschub f [mm] bei Bohrerdurchmesser					
	Innenkühlung	Außenkühlung	MMS	Luft	3,00	4,00	5,50	7,50	10,00	12,00
				90	0,04	0,04	0,05	0,06	0,07	0,08
				75	0,04	0,04	0,05	0,06	0,07	0,08
				75	0,04	0,04	0,05	0,06	0,07	0,08

Die angegebenen Schnittwerte sind Richtwerte.

Die für den jeweiligen Bearbeitungsfall optimalen Daten sollten im Versuch oder während der Bearbeitung ermittelt werden.

Schnittwertempfehlung für Vollhartmetallbohrer

Vorschub und Schnittgeschwindigkeit

MEGA-180°-Drill-Alu | SCD241

MZG*		Werkstoff	Festigkeit/Härte [N/mm ²] [HRC]
N	N1	N1.1 Aluminium, unlegiert und legiert < 3 % Si	
		N1.2 Aluminium, legiert ≤ 7 % Si	
		N1.3 Aluminium, legiert > 7-12 % Si	
		N1.4 Aluminium, legiert > 12 % Si	
	N2	N2.1 Kupfer, unlegiert und niedriglegiert	< 300
		N2.2 Kupfer, legiert	> 300
		N2.3 Messing, Bronze, Rotguss	< 1.200

ECU-G-Drill | SCD211

MZG*		Werkstoff	Festigkeit/Härte [N/mm ²] [HRC]
K	K1	K1.1 Gusseisen mit Lamellengraphit (Grauguss), GJL	< 300
		K2.1 Gusseisen mit Kugelgraphit, GJS	< 500
	K2	K2.2 Gusseisen mit Kugelgraphit, GJS	≤ 800
		K2.3 Gusseisen mit Kugelgraphit, GJS	> 800
N	N1	N1.1 Aluminium, unlegiert und legiert < 3 % Si	
		N1.2 Aluminium, legiert ≤ 7 % Si	
		N1.3 Aluminium, legiert > 7-12 % Si	
		N1.4 Aluminium, legiert > 12 % Si	
	N2	N2.1 Kupfer, unlegiert und niedriglegiert	< 300
		N2.2 Kupfer, legiert	> 300
		N2.3 Messing, Bronze, Rotguss	< 1.200

	Schnittgeschwindigkeit v_c [m/min]				Vorschub f [mm] bei Bohrerdurchmesser					
	Innenkühlung	Außenkühlung	MMS	Luft	3,00	4,50	6,50	9,50	14,00	20,00
	240	160	200		0,07	0,09	0,12	0,16	0,20	0,24
	200	145	160		0,09	0,12	0,16	0,21	0,26	0,31
	175	120	145		0,09	0,12	0,16	0,21	0,26	0,31
	145	95	120		0,09	0,12	0,16	0,21	0,26	0,31
	110	80			0,07	0,09	0,12	0,16	0,20	0,24
	95	70			0,09	0,12	0,16	0,21	0,26	0,31
	160	130	130	95	0,09	0,14	0,19	0,25	0,33	0,39

	Schnittgeschwindigkeit v_c [m/min]				Vorschub f [mm] bei Bohrerdurchmesser					
	Innenkühlung	Außenkühlung	MMS	Luft	3,00	4,50	6,50	9,50	14,00	20,00
	90	65	65	65	0,08	0,12	0,16	0,22	0,29	0,34
	120	75	90	90	0,08	0,12	0,16	0,21	0,27	0,32
	75	55	55		0,08	0,10	0,14	0,18	0,23	0,27
	215	155	170		0,08	0,10	0,14	0,18	0,23	0,27
	185	130	155		0,08	0,10	0,14	0,18	0,23	0,27
	155	100	130		0,08	0,10	0,14	0,18	0,23	0,27
	160	130	130	95	0,08	0,12	0,16	0,22	0,29	0,34

Die angegebenen Schnittwerte sind Richtwerte.

Die für den jeweiligen Bearbeitungsfall optimalen Daten sollten im Versuch oder während der Bearbeitung ermittelt werden.



VOLLBOHREN MIT WECHSELKOPFSYSTEM

Schneidplattenbohrer QTD

Technologie	184
Typ 01 - Steel	186
Typ 05 - Steel-Pyramid	188
Typ 10 - Uni, Form EK	190
Typ 02 - Inox	191
Typ 04 - Iron	193
Typ 03 - Alu	194
Schneidplattenhalter QTS	195
Zubehör und Ersatzteile	199
Schnittwertempfehlung	200

Wechselkopfbohrer TTD

Technologie	204
Typ 01 - Uni-Plus	206
Typ 04 - Steel	207
Typ 02 - Inox	209
Typ 05 - Iron	211
Typ 03 - Alu	212
Wechselkopfhalter TTS	213
Zubehör und Ersatzteile	222
Schnittwertempfehlung	224

Wechselkopfbohrer TTD-Tritan

Technologie	228
Typ 01 - Uni	230
Wechselkopfhalter TTS-300	231
Zubehör und Ersatzteile	234
Schnittwertempfehlung	236





SCHNEIDPLATTENBOHRER QTD

Stabile Schneidenaufnahme, einfaches Spannsystem

Mit modernster Fertigungstechnologie im Durchmesserbereich von acht bis 50 mm

Den Schneidplattenbohrer QTD für den mittleren bis oberen Durchmesserbereich zeichnen eine sehr gute Spanformung und eine sichere Spanabfuhr aus. Zahlreiche Schneidplattenwechsel pro Halter sind möglich, da der Grundhalter nicht ausgewaschen wird. Besonders einfach und zugleich effektiv ist auch das Spannsystem für die Schneidplatte aufgebaut. Es besteht aus einer Schraube, die quer durch die Schneidplatte geschraubt wird und die Schneidplatte stabil unter Vorspannung in der Prismenaufnahme spannt. Die Schneidplatte wird besonders stabil in der Prismenaufnahme gehalten, was hohe Schnittdaten und Bohrungsqualitäten ermöglicht.

Additive Fertigung ermöglicht optimale Kühlkanalausführung und Durchmesser ab 9 mm

Um auch Durchmesser kleiner 13 mm realisieren zu können wird die additive Fertigung eingesetzt. Dieses Verfahren ermöglicht es, Grundkörper im Durchmesserbereich von acht bis 13 mm mit gewendelten Kühlkanälen herzustellen. So erreicht der QTD mit gewendelten Kanälen im Vergleich zur zentralen Kühlmittelführung mit Umlenkungen einen um 100 Prozent gesteigerten Kühlmitteldurchfluss, speziell durch die von der Kreisform abweichenden Kühlkanalprofile.

Werkzeugfeatures im Detail



1 Schaft nach ISO 9766

2 Schaftplananlage

3 Kennlinie für maximale Bohrtiefe

4 Rückenfreilegung
– Für optimale Spanabfuhr

5 Optimale Kraftübertragung
– Durch eingebettete Schneidplatte

6 Gehärtete Stahlaufnahme mit Zylinderschaft

7 Stabile Spannung TORX PLUS®

8 Prismatischer Plattensitz
– Für optimale Zentrierung der Schneidplatte



AUF EINEN BLICK

- Hohe Lagerverfügbarkeit
- Durchmesserbereich von 9 bis 50 mm
- Halterprogramm 1,5 | 3 | 5 | 8 und 12xD
- Schneidplatten für Stahl, Edelstahl, Aluminium und Guss
- Mit Innenkühlung
- Spezielle Oberflächenbehandlung
- Einfaches Handling, Schneidplattenwechsel in der Maschine

LEISTUNGSMERKMALE

- Gleiche Performance wie Vollhartmetallbohrer
- Hohe Rundlaufgenauigkeit
- Stabiler Bund zur Aufnahme hoher Axialkräfte
- Sichere Spannung der Schneidplatte durch TORX PLUS®-Schraube
- Robustes System

VORTEILE

- Kostenoptimiert
- Höchste Performance
- Verwechslungssicherer Schneidplatteneinbau
- Optimale Spanbildung in der Schneidplatte und Spanabfuhr
- Ein Halter für alle Bohrergeometrien
- Viele Schneidplattenwechsel pro Halter möglich, da keine Auswaschung des Grundhalters

Schneidplatten QTD

Aus Vollhartmetall, innere Kühlmittelzufuhr
Typ 01 - Steel

Ausführung:

Bohrerdurchmesser: 9,00 - 50,00 mm
Bohrungstoleranz: \geq IT 10
Schneidstoff: HP240
Schneidenanzahl: 2
Anzahl Führungsfasen: 2
Spitzenwinkel: 135°

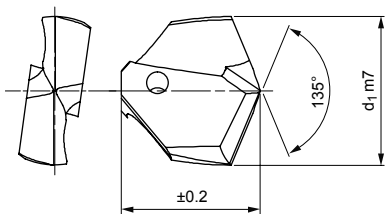

Lagerhaltige Vorzugsbaureihe

d ₁ von 9,00 bis 15,50			
d ₁ m7	Haltergröße D	Spezifikation	Bestell-Nr.
9,00	9	QTD-2F01-0900-HP240	30615635
9,50	9,5	QTD-2F01-0950-HP240	30615636
10,00	10	QTD-2F01-1000-HP240	30615638
10,20	10	QTD-2F01-1020-HP240	30646024
10,50	10,5	QTD-2F01-1050-HP240	30615639
10,70	10,5	QTD-2F01-1070-HP240	30615640
11,00	11	QTD-2F01-1100-HP240	30615641
11,50	11,5	QTD-2F01-1150-HP240	30615642
12,00	12	QTD-2F01-1200-HP240	30615644
12,50	12,5	QTD-2F01-1250-HP240	30615645
12,70	12,5	QTD-2F01-1270-HP240	30615646
12,80	12,5	QTD-2F01-1280-HP240	30646043
13,00	13	QTD-2F01-1300-HP240	30572990
13,10	13	QTD-2F01-1310-HP240	30646045
13,30	13	QTD-2F01-1330-HP240	30646047
13,40	13	QTD-2F01-1340-HP240	30646048
13,50	13,5	QTD-2F01-1350-HP240	30572991
13,80	13,5	QTD-2F01-1380-HP240	30646050
13,90	13,5	QTD-2F01-1390-HP240	30646051
14,00	14	QTD-2F01-1400-HP240	30572993
14,10	14	QTD-2F01-1410-HP240	30646052
14,20	14	QTD-2F01-1420-HP240	30646053
14,30	14	QTD-2F01-1430-HP240	30646055
14,50	14,5	QTD-2F01-1450-HP240	30572994
14,60	14,5	QTD-2F01-1460-HP240	30646057
14,70	14,5	QTD-2F01-1470-HP240	30572995
14,80	14,5	QTD-2F01-1480-HP240	30646058
14,90	14,5	QTD-2F01-1490-HP240	30646059
15,00	15	QTD-2F01-1500-HP240	30572997
15,10	15	QTD-2F01-1510-HP240	30646060
15,20	15	QTD-2F01-1520-HP240	30646061
15,25	15	QTD-2F01-1525-HP240	30572998
15,50	15	QTD-2F01-1550-HP240	30572999

d ₁ von 15,70 bis 19,50			
d ₁ m7	Haltergröße D	Spezifikation	Bestell-Nr.
15,70	15	QTD-2F01-1570-HP240	30573000
15,80	15	QTD-2F01-1580-HP240	30646066
15,90	15	QTD-2F01-1590-HP240	30646068
16,00	16	QTD-2F01-1600-HP240	30573001
16,10	16	QTD-2F01-1610-HP240	30573003
16,20	16	QTD-2F01-1620-HP240	30646069
16,25	16	QTD-2F01-1625-HP240	30573004
16,30	16	QTD-2F01-1630-HP240	30610882
16,40	16	QTD-2F01-1640-HP240	30646071
16,50	16	QTD-2F01-1650-HP240	30573005
16,60	16	QTD-2F01-1660-HP240	30646072
16,70	16	QTD-2F01-1670-HP240	30573006
16,80	16	QTD-2F01-1680-HP240	30646074
16,90	16	QTD-2F01-1690-HP240	30646075
17,00	17	QTD-2F01-1700-HP240	30573009
17,10	17	QTD-2F01-1710-HP240	30646076
17,20	17	QTD-2F01-1720-HP240	30646077
17,30	17	QTD-2F01-1730-HP240	30646078
17,40	17	QTD-2F01-1740-HP240	30646079
17,50	17	QTD-2F01-1750-HP240	30573010
17,60	17	QTD-2F01-1760-HP240	30646081
17,70	17	QTD-2F01-1770-HP240	30573011
17,80	17	QTD-2F01-1780-HP240	30646082
17,90	17	QTD-2F01-1790-HP240	30646083
18,00	18	QTD-2F01-1800-HP240	30573012
18,10	18	QTD-2F01-1810-HP240	30646084
18,50	18	QTD-2F01-1850-HP240	30573014
18,60	18	QTD-2F01-1860-HP240	30646088
18,70	18	QTD-2F01-1870-HP240	30573015
18,80	18	QTD-2F01-1880-HP240	30646089
18,90	18	QTD-2F01-1890-HP240	30646090
19,00	19	QTD-2F01-1900-HP240	30573016
19,50	19	QTD-2F01-1905-HP240	30646091

Schneidplatten QTD aus Vollhartmetall, innere Kühlmittelzufuhr – Typ 01

d ₁ von 19,10 bis 24,70				d ₁ von 24,75 bis 42,60			
d ₁ m7	Haltergröße D	Spezifikation	Bestell-Nr.	d ₁ m7	Haltergröße D	Spezifikation	Bestell-Nr.
19,10	19	QTD-2F01-1910-HP240	30646092	24,75	24	QTD-2F01-2475-HP240	30573046
19,20	19	QTD-2F01-1920-HP240	30573017	24,80	24	QTD-2F01-2480-HP240	30660662
19,25	19	QTD-2F01-1925-HP240	30573018	25,00	25	QTD-2F01-2500-HP240	30573047
19,30	19	QTD-2F01-1930-HP240	30646094	25,40	25	QTD-2F01-2540-HP240	30573048
19,50	19	QTD-2F01-1950-HP240	30573020	25,50	25	QTD-2F01-2550-HP240	30573049
19,60	19	QTD-2F01-1960-HP240	30646095	25,70	25	QTD-2F01-2570-HP240	30573050
19,70	19	QTD-2F01-1970-HP240	30573021	25,80	25	QTD-2F01-2580-HP240	30584730
19,75	19	QTD-2F01-1975-HP240	30573022	26,00	26	QTD-2F01-2600-HP240	30573051
19,80	19	QTD-2F01-1980-HP240	30646096	26,50	26	QTD-2F01-2650-HP240	30573052
19,90	19	QTD-2F01-1990-HP240	30646097	27,00	27	QTD-2F01-2700-HP240	30573053
20,00	20	QTD-2F01-2000-HP240	30573023	27,50	27	QTD-2F01-2750-HP240	30573054
20,40	20	QTD-2F01-2040-HP240	30573024	27,75	27	QTD-2F01-2775-HP240	30573055
20,50	20	QTD-2F01-2050-HP240	30573025	28,00	28	QTD-2F01-2800-HP240	30573056
20,70	20	QTD-2F01-2070-HP240	30573026	28,50	28	QTD-2F01-2850-HP240	30573058
20,75	20	QTD-2F01-2075-HP240	30573027	29,00	29	QTD-2F01-2900-HP240	30573059
21,00	21	QTD-2F01-2100-HP240	30573028	29,50	29	QTD-2F01-2950-HP240	30573060
21,50	21	QTD-2F01-2150-HP240	30573029	29,80	29	QTD-2F01-2980-HP240	30728319
21,70	21	QTD-2F01-2170-HP240	30573030	30,00	30	QTD-2F01-3000-HP240	30573062
22,00	22	QTD-2F01-2200-HP240	30573031	30,25	30	QTD-2F01-3025-HP240	30573063
22,25	22	QTD-2F01-2225-HP240	30573032	30,50	30	QTD-2F01-3050-HP240	30573064
22,50	22	QTD-2F01-2250-HP240	30573034	31,00	31	QTD-2F01-3100-HP240	30573066
22,70	22	QTD-2F01-2270-HP240	30573035	31,50	31	QTD-2F01-3150-HP240	30573067
22,75	22	QTD-2F01-2275-HP240	30573036	32,00	32	QTD-2F01-3200-HP240	30573068
23,00	23	QTD-2F01-2300-HP240	30573037	33,00	33	QTD-2F01-3300-HP240	30649656
23,25	23	QTD-2F01-2325-HP240	30573038	34,00	34	QTD-2F01-3400-HP240	30649657
23,50	23	QTD-2F01-2350-HP240	30573039	35,00	35	QTD-2F01-3500-HP240	30649658
23,75	23	QTD-2F01-2375-HP240	30573042	36,00	36	QTD-2F01-3600-HP240	30649659
24,00	24	QTD-2F01-2400-HP240	30573043	37,00	37	QTD-2F01-3700-HP240	30649660
24,30	24	QTD-2F01-2430-HP240	30646105	38,00	37	QTD-2F01-3800-HP240	30649661
24,50	24	QTD-2F01-2450-HP240	30573044	40,00	39	QTD-2F01-4000-HP240	30657233
24,70	24	QTD-2F01-2470-HP240	30573045	42,00	41	QTD-2F01-4200-HP240	30657235

Konfigurierbare Merkmale



Durchmesser:
Durchmesser in Abstufungen
von 0,01 mm frei wählbar



Spezifikation:

QTD-2F01-[Durchmesser]-HP240

Beispiel:

QTD-2F01-0901-HP240

Werkzeugdurchmesser d₁ = 9,01 mm

Abmessungen konfigurierbare Baureihe

d ₁ min.	d ₁ max.
9,00	50,00

Maßangaben in mm.

Schnittwertempfehlung siehe Kapitelende.

Sonderausführungen und andere Beschichtungen auf Anfrage.

Schneidplatten QTD

Aus Vollhartmetall, innere Kühlmittelzufuhr
Typ 05 - Steel-Pyramid

Ausführung:

Bohrerdurchmesser:	14,00 - 32,00 mm
Bohrungstoleranz:	≥ IT 10
Schneidstoff:	HP605
Schneidenanzahl:	2
Anzahl Führungsfasen:	2
Spitzenwinkel:	165°

Anwendung:

Für Bearbeitungen mit besonderem Anspruch an die Werkzeug-Zentrierung. (z. B. dünnwandige Bauteile, labile Bearbeitungsverhältnisse).

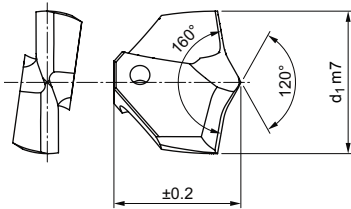

Lagerhaltige Vorzugsbaureihe

Baumaße		Spezifikation	Bestell-Nr.
d ₁ m7	Haltergröße D		
14,00	14	QTD-2F05-1400-HP605	31126352
15,00	15	QTD-2F05-1500-HP605	31126356
16,00	16	QTD-2F05-1600-HP605	31126361
16,50	16	QTD-2F05-1650-HP605	31126364
17,50	17	QTD-2F05-1750-HP605	31126366
18,00	18	QTD-2F05-1800-HP605	31126368
18,50	18	QTD-2F05-1850-HP605	31126369
19,27	19	QTD-2F05-1927-HP605	31208007
19,80	19	QTD-2F05-1980-HP605	31126372
20,00	20	QTD-2F05-2000-HP605	31126373
20,50	20	QTD-2F05-2050-HP605	31126374
21,00	21	QTD-2F05-2100-HP605	31126375
21,50	21	QTD-2F05-2150-HP605	31126376
22,00	22	QTD-2F05-2200-HP605	31126377
23,00	23	QTD-2F05-2300-HP605	31126379
24,00	24	QTD-2F05-2400-HP605	31126380
25,00	25	QTD-2F05-2500-HP605	31126382
26,00	26	QTD-2F05-2600-HP605	31126384
26,50	26	QTD-2F05-2650-HP605	31126385
27,00	27	QTD-2F05-2700-HP605	31126386
28,00	28	QTD-2F05-2800-HP605	31126387
29,00	29	QTD-2F05-2900-HP605	31126388
30,00	30	QTD-2F05-3000-HP605	31126389
32,00	32	QTD-2F05-3200-HP605	31126391

Konfigurierbare Merkmale



Durchmesser:
Durchmesser in Abstufungen
von 0,01 mm frei wählbar



Spezifikation:

QTD-2F01-[Durchmesser]-HP240

Abmessungen konfigurierbare Baureihe

d ₁ min.	d ₁ max.
14,00	32,00

Beispiel:

QTD-2F01-1401-HP240

Werkzeugdurchmesser d₁ = 14,01 mm

Maßangaben in mm.

Schnittwertempfehlung siehe Kapitelende.

Sonderausführungen und andere Beschichtungen auf Anfrage.

Praxistest

Bearbeitung von Blechen, Wärmetauschern / Kesselblechen, Stahlträgern (T, U, ...).

Speziell für die Bearbeitung mit besonderem Anspruch an die Werkzeugzentrierung sowie für dünnwandige Bauteile und labile Bearbeitungsverhältnisse.



Bearbeitungsdaten

Werkzeug: \varnothing 18 mm | 5xD
 Spannfutter: Flächenspannfutter
 Kühlung: MMS-Innenkühlung

l_B [mm]: 90
 v_C [m/min]: 63
 n [min^{-1}]: 1.115
 f [mm]: 0,3
 v_f [mm/min]: 334

Anzahl Bohrungen

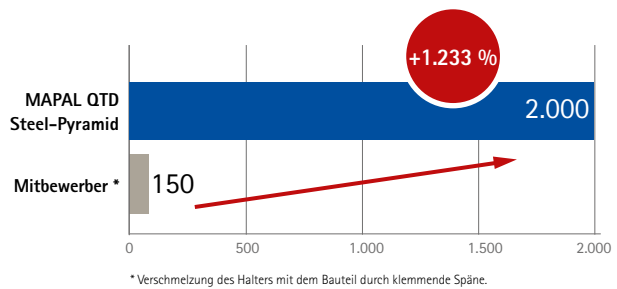

Schneidplatten QTD

Aus Vollhartmetall,
Typ 10 - Uni, Form EK

Ausführung:

Bohrerdurchmesser: 10,00 - 33,00 mm
Bohrungstoleranz: \geq IT 10
Schneidstoff: HP240
Schneidenanzahl: 2
Anzahl Führungsfasen: 2
Spitzenwinkel: 142°
Besonderheiten: Form EK
180° Schneide,
Schutzfase 0,5 mm

Anwendung:

Für Schrauben-Durchgangsbohrungen nach DIN-ISO 273 und Senkungen nach DIN 74, Blatt 2 Form H, J und K, Ausführung mittel. Für Schrauben nach DIN 912, 6912 und 7984, ISO 1207 (DIN 84).

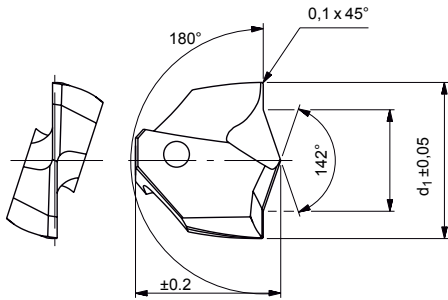

Lagerhaltige Vorzugsbaureihe

Baumaße		Für Zylinderkopf-DIN-Schrauben	Passend für \varnothing Durchgangsbohrung	Spezifikation	Bestell-Nr.
$d_2 \pm 0,05$	Haltergröße D				
10,00	10	M5	5,5	QTD-2F10-1000-HP240	30868435
11,00	11	M6	6,6	QTD-2F10-1100-HP240	30868436
15,00	15	M8	9	QTD-2F10-1500-HP240	30868437
18,00	18	M10	11	QTD-2F10-1800-HP240	30868438
20,00	20	M12	13,5	QTD-2F10-2000-HP240	30868439
24,00	24	M14	15	QTD-2F10-2400-HP240	30868440
26,00	26	M16	17	QTD-2F10-2600-HP240	30868441
30,00	30	M18	19	QTD-2F10-3000-HP240	30868442
33,00	33	M20	21	QTD-2F10-3300-HP240	30868443

Anwendungshinweis:

Erstellung einer Schrauben-Durchgangsbohrung mit Flachsenkung für Zylinderkopfschrauben nach DIN (Beispiel M12)

1. Schritt:

Senkung mit QTD Typ10, Form EK
(Beispiel Durchmesser 20 mm)

2. Schritt:

Bohrung mit Vollbohrer
(Beispiel Durchmesser 13,5 mm)

Ergebnis:

Schrauben-Durchgangsbohrung mit Flachsenkung
und Fase für M12 Zylinderkopfschraube

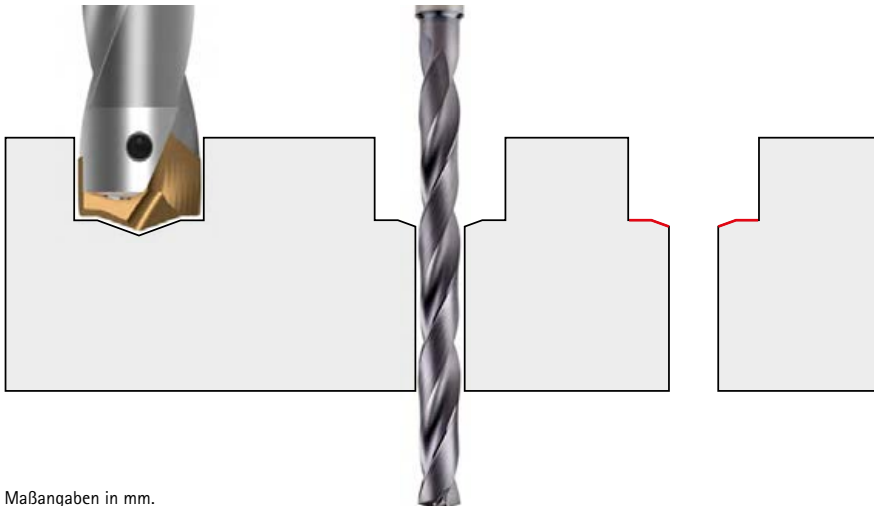

Maßangaben in mm.

Schnittwertempfehlung siehe Kapitelende.

Sonderausführungen und andere Beschichtungen auf Anfrage.

Schneidplatten QTD

Aus Vollhartmetall, innere Kühlmittelzufuhr
Typ 02 - Inox

Ausführung:

Bohrerdurchmesser: 9,00 - 50,00 mm
Bohrungstoleranz: \geq IT 10
Schneidstoff: HP600
Schneidenanzahl: 2
Anzahl Führungsfasen: 2
Spitzenwinkel: 135°

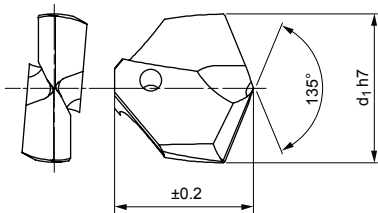

Lagerhaltige Vorzugsbaureihe

d ₁ von 10,00 bis 16,70			
d ₁ h7	Haltergröße D	Spezifikation	Bestell-Nr.
10,00	10	QTD-2F02-1000-HP600	30615624
10,50	10,5	QTD-2F02-1050-HP600	30615625
11,00	11	QTD-2F02-1100-HP600	30615627
12,00	12	QTD-2F02-1200-HP600	30615630
12,50	12,5	QTD-2F02-1250-HP600	30615631
13,00	13	QTD-2F02-1300-HP600	30573070
13,50	13,5	QTD-2F02-1350-HP600	30573072
14,00	14	QTD-2F02-1400-HP600	30573074
14,10	14	QTD-2F02-1410-HP600	30646120
14,20	14	QTD-2F02-1420-HP600	30630410
14,30	14	QTD-2F02-1430-HP600	30646122
14,40	14	QTD-2F02-1440-HP600	30646123
14,50	14,5	QTD-2F02-1450-HP600	30573075
14,60	14,5	QTD-2F02-1460-HP600	30646124
14,70	14,5	QTD-2F02-1470-HP600	30573076
14,75	14,5	QTD-2F02-1475-HP600	30573077
14,80	14,5	QTD-2F02-1480-HP600	30646125
15,00	15	QTD-2F02-1500-HP600	30573078
15,20	15	QTD-2F02-1520-HP600	30646128
15,25	15	QTD-2F02-1525-HP600	30573079
15,40	15	QTD-2F02-1540-HP600	30646130
15,50	15	QTD-2F02-1550-HP600	30573080
15,60	15	QTD-2F02-1560-HP600	30646131
15,70	15	QTD-2F02-1570-HP600	30573081
15,80	15	QTD-2F02-1580-HP600	30646132
16,00	16	QTD-2F02-1600-HP600	30573083
16,10	16	QTD-2F02-1610-HP600	30573086
16,20	16	QTD-2F02-1620-HP600	30646134
16,30	16	QTD-2F02-1630-HP600	30646135
16,40	16	QTD-2F02-1640-HP600	30646136
16,50	16	QTD-2F02-1650-HP600	30573088
16,60	16	QTD-2F02-1660-HP600	30646137
16,70	16	QTD-2F02-1670-HP600	30573089

d ₁ von 16,75 bis 23,75			
d ₁ h7	Haltergröße D	Spezifikation	Bestell-Nr.
16,75	16	QTD-2F02-1675-HP600	30573090
16,80	16	QTD-2F02-1680-HP600	30646138
16,90	16	QTD-2F02-1690-HP600	30646139
17,00	17	QTD-2F02-1700-HP600	30573091
17,30	17	QTD-2F02-1730-HP600	30646142
17,40	17	QTD-2F02-1740-HP600	30646143
17,50	17	QTD-2F02-1750-HP600	30573092
17,70	17	QTD-2F02-1770-HP600	30573093
17,90	17	QTD-2F02-1790-HP600	30646146
18,00	18	QTD-2F02-1800-HP600	30573094
18,50	18	QTD-2F02-1850-HP600	30573096
18,60	18	QTD-2F02-1860-HP600	30646151
18,70	18	QTD-2F02-1870-HP600	30573097
19,00	19	QTD-2F02-1900-HP600	30573098
19,40	19	QTD-2F02-1940-HP600	30573101
19,50	19	QTD-2F02-1950-HP600	30573102
19,60	19	QTD-2F02-1960-HP600	30646157
19,70	19	QTD-2F02-1970-HP600	30573103
19,75	19	QTD-2F02-1975-HP600	30573104
19,80	19	QTD-2F02-1980-HP600	30646158
19,90	19	QTD-2F02-1990-HP600	30646159
20,00	20	QTD-2F02-2000-HP600	30573105
20,40	20	QTD-2F02-2040-HP600	30573106
20,50	20	QTD-2F02-2050-HP600	30573107
21,00	21	QTD-2F02-2100-HP600	30573110
21,50	21	QTD-2F02-2150-HP600	30573111
21,70	21	QTD-2F02-2170-HP600	30573112
22,00	22	QTD-2F02-2200-HP600	30573113
22,25	22	QTD-2F02-2225-HP600	30573114
22,70	22	QTD-2F02-2270-HP600	30573117
23,00	23	QTD-2F02-2300-HP600	30573119
23,50	23	QTD-2F02-2350-HP600	30573121
23,75	23	QTD-2F02-2375-HP600	30573124

Fortsetzung auf nächster Seite.

Schneidplatten QTD aus Vollhartmetall, innere Kühlmittelzufuhr – Typ 02

d ₁ von 24,00 bis 27,00			
d ₁ h7	Haltergröße D	Spezifikation	Bestell-Nr.
24,00	24	QTD-2F02-2400-HP600	30573125
24,40	24	QTD-2F02-2440-HP600	30665151
24,50	24	QTD-2F02-2450-HP600	30573126
24,70	24	QTD-2F02-2470-HP600	30573127
24,75	24	QTD-2F02-2475-HP600	30573128
25,00	25	QTD-2F02-2500-HP600	30573129
25,50	25	QTD-2F02-2550-HP600	30573131
25,70	25	QTD-2F02-2570-HP600	30573132
26,00	26	QTD-2F02-2600-HP600	30573133
26,50	26	QTD-2F02-2650-HP600	30573134
27,00	27	QTD-2F02-2700-HP600	30573135

d ₁ von 27,50 bis 40,00			
d ₁ h7	Haltergröße D	Spezifikation	Bestell-Nr.
27,50	27	QTD-2F02-2750-HP600	30573136
28,00	28	QTD-2F02-2800-HP600	30573138
29,00	29	QTD-2F02-2900-HP600	30573141
29,50	29	QTD-2F02-2950-HP600	30573142
30,00	30	QTD-2F02-3000-HP600	30573143
30,75	30	QTD-2F02-3075-HP600	30573146
33,00	33	QTD-2F02-3300-HP600	30649662
36,00	36	QTD-2F02-3600-HP600	30649665
37,00	37	QTD-2F02-3700-HP600	30649666
40,00	39	QTD-2F02-4000-HP600	30657246

Konfigurierbare Merkmale



Durchmesser:
Durchmesser in Abstufungen von 0,01 mm frei wählbar



Spezifikation:
QTD-2F02-[Durchmesser]-HP600

Beispiel:
QTD-2F02-1401-HP600

Werkzeugdurchmesser d₁ = 14,01 mm

Abmessungen konfigurierbare Baureihe

d ₁ min.	d ₁ max.
9,00	50,00

Maßangaben in mm.

Schnittwertempfehlung siehe Kapitelende.

Sonderausführungen und andere Beschichtungen auf Anfrage.

Schneidplatten QTD

Aus Vollhartmetall, innere Kühlmittelzufuhr
Typ 04 - Iron

Ausführung:

Bohrerdurchmesser: 9,00 - 50,00 mm
Bohrungstoleranz: \geq IT 10
Schneidstoff: HP240
Schneidenanzahl: 2
Anzahl Führungsfasen: 2
Spitzenwinkel: 135°

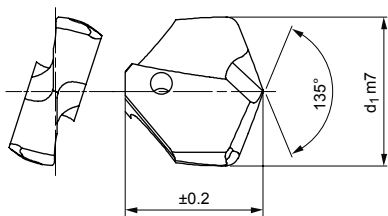

Lagerhaltige Vorzugsbaureihe

d ₁ von 12,00 bis 23,00			
d ₁ m7	Haltergröße D	Spezifikation	Bestell-Nr.
12,00	12	QTD-2F04-1200-HP240	30615805
14,00	14	QTD-2F04-1400-HP240	30612900
14,50	14,5	QTD-2F04-1450-HP240	30612901
17,00	17	QTD-2F04-1700-HP240	30612915
17,50	17	QTD-2F04-1750-HP240	30612916
18,00	18	QTD-2F04-1800-HP240	30612918
19,00	19	QTD-2F04-1900-HP240	30612922
19,10	19	QTD-2F04-1910-HP240	30646366
19,50	19	QTD-2F04-1950-HP240	30612926
20,50	20	QTD-2F04-2050-HP240	30612931
21,00	21	QTD-2F04-2100-HP240	30612934
21,50	21	QTD-2F04-2150-HP240	30612935
22,00	22	QTD-2F04-2200-HP240	30612937
23,00	23	QTD-2F04-2300-HP240	30612943

d ₁ von 23,50 bis 33,00			
d ₁ m7	Haltergröße D	Spezifikation	Bestell-Nr.
23,50	23	QTD-2F04-2350-HP240	30612945
24,00	24	QTD-2F04-2400-HP240	30612949
24,50	24	QTD-2F04-2450-HP240	30612950
25,00	25	QTD-2F04-2500-HP240	30612953
25,70	25	QTD-2F04-2570-HP240	30612956
26,00	26	QTD-2F04-2600-HP240	30612957
26,50	26	QTD-2F04-2650-HP240	30612958
28,00	28	QTD-2F04-2800-HP240	30612962
28,50	28	QTD-2F04-2850-HP240	30612964
29,00	29	QTD-2F04-2900-HP240	30612965
29,50	29	QTD-2F04-2950-HP240	30612966
30,00	30	QTD-2F04-3000-HP240	30612967
31,00	31	QTD-2F04-3100-HP240	30612971
33,00	33	QTD-2F04-3300-HP240	30649674

Konfigurierbare Merkmale



Durchmesser:
Durchmesser in Abstufungen
von 0,01 mm frei wählbar



Spezifikation:

QTD-2F02-[Durchmesser]-HP600

Beispiel:

QTD-2F02-1401-HP600

Werkzeugdurchmesser d₁ = 14,01 mm

Abmessungen konfigurierbare Baureihe

d ₁ min.	d ₁ max.
9,00	50,00

Maßangaben in mm.

Schnittwertempfehlung siehe Kapitelende.

Sonderausführungen und andere Beschichtungen auf Anfrage.

Schneidplatten QTD

Aus Vollhartmetall, innere Kühlmittelzufuhr
Typ 03 - Alu

Ausführung:

Bohrerdurchmesser: 9,00 - 50,00 mm
Bohrungstoleranz: \geq IT 10
Schneidstoff: HU310
Schneidenanzahl: 2
Anzahl Führungsfasen: 2
Spitzenwinkel: 135°

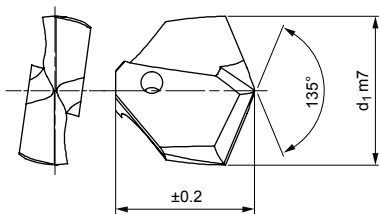

Lagerhaltige Vorzugsbaureihe

d ₁ von 13,00 bis 20,50			
d ₁ m7	Haltergröße D	Spezifikation	Bestell-Nr.
13,00	13	QTD-2F03-1300-HU310	30612819
13,50	13,5	QTD-2F03-1350-HU310	30612820
14,00	14	QTD-2F03-1400-HU310	30612822
14,50	14,5	QTD-2F03-1450-HU310	30612823
15,00	15	QTD-2F03-1500-HU310	30612826
15,50	15	QTD-2F03-1550-HU310	30612828
16,00	16	QTD-2F03-1600-HU310	30612830
17,00	17	QTD-2F03-1700-HU310	30612837
17,50	17	QTD-2F03-1750-HU310	30612838
18,25	18	QTD-2F03-1825-HU310	30612841
18,50	18	QTD-2F03-1850-HU310	30612842
19,00	19	QTD-2F03-1900-HU310	30612844
20,00	20	QTD-2F03-2000-HU310	30612851
20,50	20	QTD-2F03-2050-HU310	30612853

d ₁ von 21,00 bis 36,00			
d ₁ m7	Haltergröße D	Spezifikation	Bestell-Nr.
21,00	21	QTD-2F03-2100-HU310	30612856
22,00	22	QTD-2F03-2200-HU310	30612859
22,50	22	QTD-2F03-2250-HU310	30612862
23,00	23	QTD-2F03-2300-HU310	30612865
23,50	23	QTD-2F03-2350-HU310	30612867
24,00	24	QTD-2F03-2400-HU310	30612871
24,50	24	QTD-2F03-2450-HU310	30612872
25,00	25	QTD-2F03-2500-HU310	30612875
26,00	26	QTD-2F03-2600-HU310	30612879
27,00	27	QTD-2F03-2700-HU310	30612881
29,50	29	QTD-2F03-2950-HU310	30612888
30,00	30	QTD-2F03-3000-HU310	30612889
34,00	34	QTD-2F03-3400-HU310	30649669
36,00	36	QTD-2F03-3600-HU310	30649671

Konfigurierbare Merkmale



Durchmesser:
Durchmesser in Abstufungen
von 0,01 mm frei wählbar



Spezifikation:

QTD-2F03-[Durchmesser]-HU310

Beispiel:

QTD-2F02-1401-HU310

Werkzeugdurchmesser d₁ = 14,01 mm

Abmessungen konfigurierbare Baureihe

d ₁ min.	d ₁ max.
9,00	50,00

Maßangaben in mm.

Schnittwertempfehlung siehe Kapitelende.

Sonderausführungen und andere Beschichtungen auf Anfrage.

Schneidplattenhalter QTS

Mit Prismenaufnahme für QTD-Schneidplatten
QTS100S, innere Kühlmittelzufuhr

Ausführung:

Für Durchmesser:

9,00 - 50,99 mm

Schaftform:

nach ISO 9766

Wechselsystem:

Prismenaufnahme,
Schneidenwechsel
auf der Maschine
möglich

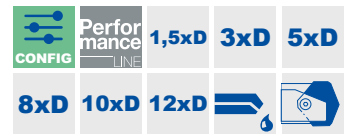
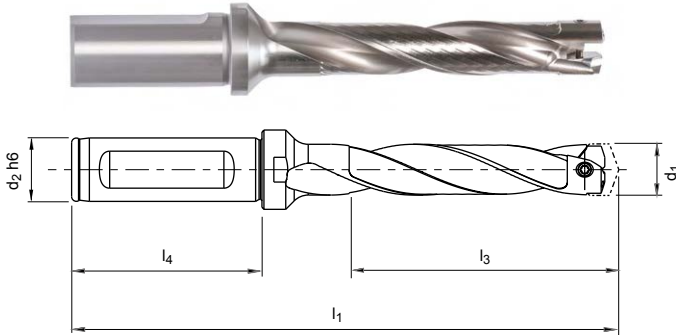

Lagerhaltige Vorzugsbaureihe

Haltergröße D	Baumaße					Spezifikation	Bestell-Nr.
	Durchmesserbereich Schneidplatte d ₁	d ₂ h6	l ₁	l ₃	l ₄		
9,00	9,00 - 9,49	12	110	48	45	QTS100S-0900-DR05-ZYL12-MN	30605484
9,50	9,50 - 9,99	12	113	50	45	QTS100S-0950-DR05-ZYL12-MN	30605485
10,00	10,00 - 10,49	16	99	32	48	QTS100S-1000-DR03-ZYL16-MN	30605476
10,00	10,00 - 10,49	16	120	53	48	QTS100S-1000-DR05-ZYL16-MN	30605486
10,50	10,50 - 10,99	16	122	55	48	QTS100S-1050-DR05-ZYL16-MN	30605487
11,00	11,00 - 11,49	16	126	58	48	QTS100S-1100-DR05-ZYL16-MN	30605488
11,00	11,00 - 11,49	16	160	92	48	QTS100S-1100-DR08-ZYL16-MN	30605498
11,50	11,50 - 11,99	16	105	36	48	QTS100S-1150-DR03-ZYL16-MN	30605479
12,00	12,00 - 12,49	16	107	38	48	QTS100S-1200-DR03-ZYL16-MN	30605480
12,00	12,00 - 12,49	16	132	63	48	QTS100S-1200-DR05-ZYL16-MN	30605490
12,00	12,00 - 12,49	16	169	100	48	QTS100S-1200-DR08-ZYL16-MN	30605500
12,50	12,50 - 12,99	16	109	39	48	QTS100S-1250-DR03-ZYL16-MN	30605481
12,50	12,50 - 12,99	16	135	65	48	QTS100S-1250-DR05-ZYL16-MN	30605491
12,50	12,50 - 12,99	16	174	104	48	QTS100S-1250-DR08-ZYL16-MN	30605501
13,00	13,00 - 13,49	16	112	41	48	QTS100S-1300-DR03-ZYL16-MN	30572922
13,00	13,00 - 13,49	16	138	68	48	QTS100S-1300-DR05-ZYL16-MN	30572945
13,00	13,00 - 13,49	16	178	108	48	QTS100S-1300-DR08-ZYL16-MN	30572967
13,00	13,00 - 13,49	16	232	162	48	QTS100S-1300-DR12-ZYL16-MN	30598728
13,50	13,50 - 13,99	16	211	140	48	QTS100S-1350-DR10-ZYL16-MN	30826051
13,50	13,50 - 13,99	16	239	168	48	QTS100S-1350-DR12-ZYL16-MN	30598729
14,00	14,00 - 14,49	16	116	44	48	QTS100S-1400-DR03-ZYL16-MN	30572924
14,00	14,00 - 14,49	16	144	73	48	QTS100S-1400-DR05-ZYL16-MN	30572947
14,00	14,00 - 14,49	16	187	116	48	QTS100S-1400-DR08-ZYL16-MN	30572970
14,00	14,00 - 14,49	16	245	174	48	QTS100S-1400-DR12-ZYL16-MN	30598730
14,50	14,50 - 14,99	16	95	23	48	QTS100S-1450-DR01-ZYL16-MN	30572903
14,50	14,50 - 14,99	16	147	75	48	QTS100S-1450-DR05-ZYL16-MN	30572948
15,00	15,00 - 15,99	20	124	48	50	QTS100S-1500-DR03-ZYL20-MN	30572926
15,00	15,00 - 15,99	20	155	80	50	QTS100S-1500-DR05-ZYL20-MN	30572949
15,00	15,00 - 15,99	20	203	128	50	QTS100S-1500-DR08-ZYL20-MN	30572972
15,00	15,00 - 15,99	20	237	162	50	QTS100S-1500-DR10-ZYL20-MN	30826054
15,00	15,00 - 15,99	20	267	192	50	QTS100S-1500-DR12-ZYL20-MN	30598732
16,00	16,00 - 16,99	20	102	26	50	QTS100S-1600-DR01-ZYL20-MN	30572905
16,00	16,00 - 16,99	20	128	51	50	QTS100S-1600-DR03-ZYL20-MN	30572927
16,00	16,00 - 16,99	20	161	85	50	QTS100S-1600-DR05-ZYL20-MN	30572950

Fortsetzung auf nächster Seite.

Schneidplattenhalter QTS | QTS100, innere Kühlmittelzufuhr

Baumaße						Spezifikation	Bestell-Nr.
Haltergröße D	Durchmesserbereich Schneidplatte d ₁	d ₂ h6	l ₁	l ₃	l ₄		
16,00	16,00 - 16,99	20	212	136	50	QTS100S-1600-DR08-ZYL20-MN	30572973
16,00	16,00 - 16,99	20	246	170	50	QTS100S-1600-DR10-ZYL20-MN	30826055
17,00	17,00 - 17,99	20	105	27	50	QTS100S-1700-DR01-ZYL20-MN	30572906
17,00	17,00 - 17,99	20	132	54	50	QTS100S-1700-DR03-ZYL20-MN	30572928
17,00	17,00 - 17,99	20	168	90	50	QTS100S-1700-DR05-ZYL20-MN	30572951
17,00	17,00 - 17,99	20	222	144	50	QTS100S-1700-DR08-ZYL20-MN	30572974
17,00	17,00 - 17,99	20	258	180	50	QTS100S-1700-DR10-ZYL20-MN	30826056
17,00	17,00 - 17,99	20	294	216	50	QTS100S-1700-DR12-ZYL20-MN	30598734
18,00	18,00 - 18,99	25	142	57	56	QTS100S-1800-DR03-ZYL25-MN	30572929
18,00	18,00 - 18,99	25	180	95	56	QTS100S-1800-DR05-ZYL25-MN	30572952
18,00	18,00 - 18,99	25	237	152	56	QTS100S-1800-DR08-ZYL25-MN	30572975
18,00	18,00 - 18,99	25	313	228	56	QTS100S-1800-DR12-ZYL25-MN	30598735
19,00	19,00 - 19,99	25	116	30	56	QTS100S-1900-DR01-ZYL25-MN	30572908
19,00	19,00 - 19,99	25	146	60	56	QTS100S-1900-DR03-ZYL25-MN	30572930
19,00	19,00 - 19,99	25	186	100	56	QTS100S-1900-DR05-ZYL25-MN	30572953
19,00	19,00 - 19,99	25	246	160	56	QTS100S-1900-DR08-ZYL25-MN	30572976
20,00	20,00 - 20,99	25	151	63	56	QTS100S-2000-DR03-ZYL25-MN	30572931
20,00	20,00 - 20,99	25	192	105	56	QTS100S-2000-DR05-ZYL25-MN	30572954
20,00	20,00 - 20,99	25	255	168	56	QTS100S-2000-DR08-ZYL25-MN	30572977
20,00	20,00 - 20,99	25	297	210	56	QTS100S-2000-DR10-ZYL25-MN	30826059
20,00	20,00 - 20,99	25	339	252	56	QTS100S-2000-DR12-ZYL25-MN	30598737
21,00	21,00 - 21,99	25	121	33	56	QTS100S-2100-DR01-ZYL25-MN	30572910
21,00	21,00 - 21,99	25	155	66	56	QTS100S-2100-DR03-ZYL25-MN	30572932
21,00	21,00 - 21,99	25	198	110	56	QTS100S-2100-DR05-ZYL25-MN	30572955
21,00	21,00 - 21,99	25	264	176	56	QTS100S-2100-DR08-ZYL25-MN	30572978
21,00	21,00 - 21,99	25	308	220	56	QTS100S-2100-DR10-ZYL25-MN	30826060
22,00	22,00 - 22,99	25	125	35	56	QTS100S-2200-DR01-ZYL25-MN	30572911
22,00	22,00 - 22,99	25	159	69	56	QTS100S-2200-DR03-ZYL25-MN	30572933
22,00	22,00 - 22,99	25	205	115	56	QTS100S-2200-DR05-ZYL25-MN	30572956
22,00	22,00 - 22,99	25	274	184	56	QTS100S-2200-DR08-ZYL25-MN	30572979
23,00	23,00 - 23,99	25	127	36	56	QTS100S-2300-DR01-ZYL25-MN	30572912
23,00	23,00 - 23,99	25	211	120	56	QTS100S-2300-DR05-ZYL25-MN	30572957
23,00	23,00 - 23,99	25	379	288	56	QTS100S-2300-DR12-ZYL25-MN	30598740
24,00	24,00 - 24,99	32	171	75	60	QTS100S-2400-DR03-ZYL32-MN	30572935
24,00	24,00 - 24,99	32	221	125	60	QTS100S-2400-DR05-ZYL32-MN	30572958
24,00	24,00 - 24,99	32	296	200	60	QTS100S-2400-DR08-ZYL32-MN	30572981
24,00	24,00 - 24,99	32	396	300	60	QTS100S-2400-DR12-ZYL32-MN	30598741
25,00	25,00 - 25,99	32	136	39	60	QTS100S-2500-DR01-ZYL32-MN	30572914
25,00	25,00 - 25,99	32	176	78	60	QTS100S-2500-DR03-ZYL32-MN	30572937
25,00	25,00 - 25,99	32	227	130	60	QTS100S-2500-DR05-ZYL32-MN	30572959
25,00	25,00 - 25,99	32	305	208	60	QTS100S-2500-DR08-ZYL32-MN	30572982
25,00	25,00 - 25,99	32	409	312	60	QTS100S-2500-DR12-ZYL32-MN	30598742
26,00	26,00 - 26,99	32	139	41	60	QTS100S-2600-DR01-ZYL32-MN	30572915
26,00	26,00 - 26,99	32	180	81	60	QTS100S-2600-DR03-ZYL32-MN	30572938
26,00	26,00 - 26,99	32	233	135	60	QTS100S-2600-DR05-ZYL32-MN	30572960
26,00	26,00 - 26,99	32	314	216	60	QTS100S-2600-DR08-ZYL32-MN	30572983
26,00	26,00 - 26,99	32	368	270	60	QTS100S-2600-DR10-ZYL32-MN	30826065
27,00	27,00 - 27,99	32	184	84	60	QTS100S-2700-DR03-ZYL32-MN	30572939
27,00	27,00 - 27,99	32	324	224	60	QTS100S-2700-DR08-ZYL32-MN	30572984
28,00	28,00 - 28,99	32	188	87	60	QTS100S-2800-DR03-ZYL32-MN	30572940
28,00	28,00 - 28,99	32	246	145	60	QTS100S-2800-DR05-ZYL32-MN	30572962
28,00	28,00 - 28,99	32	449	348	60	QTS100S-2800-DR12-ZYL32-MN	30598745
29,00	29,00 - 29,99	32	402	300	60	QTS100S-2900-DR10-ZYL32-MN	30826068
30,00	30,00 - 30,99	32	197	93	60	QTS100S-3000-DR03-ZYL32-MN	30572942
30,00	30,00 - 30,99	32	351	248	60	QTS100S-3000-DR08-ZYL32-MN	30572987
30,00	30,00 - 30,99	32	413	310	60	QTS100S-3000-DR10-ZYL32-MN	30826069

Schneidplattenhalter QTS | QTS100, innere Kühlmittelzufuhr

Haltergröße D	Baumaße					Spezifikation	Bestell-Nr.
	Durchmesserbereich Schneidplatte d ₁	d ₂ h ₆	l ₁	l ₃	l ₄		
30,00	30,00 - 30,99	32	475	372	60	QTS100S-3000-DR12-ZYL32-MN	30598747
31,00	31,00 - 31,99	32	264	160	60	QTS100S-3100-DR05-ZYL32-MN	30572965
32,00	32,00 - 32,99	32	271	165	60	QTS100S-3200-DR05-ZYL32-MN	30572966
32,00	32,00 - 32,99	32	436	330	60	QTS100S-3200-DR10-ZYL32-MN	30826071
32,00	32,00 - 32,99	32	502	396	60	QTS100S-3200-DR12-ZYL32-MN	30598749
33,00	33,00 - 33,99	32	209	102	60	QTS100S-3300-DR03-ZYL32-MN	30639167
34,00	34,00 - 34,99	32	283	175	60	QTS100S-3400-DR05-ZYL32-MN	30639172
35,00	35,00 - 35,99	32	218	108	60	QTS100S-3500-DR03-ZYL32-MN	30639169
36,00	36,00 - 36,99	32	222	111	60	QTS100S-3600-DR03-ZYL32-MN	30639170
37,00	37,00 - 38,99	40	318	195	70	QTS100S-3700-DR05-ZYL40-MN	30650288
39,00	39,00 - 40,99	40	249	123	70	QTS100S-3900-DR03-ZYL40-MN	30650284
41,00	41,00 - 42,99	40	257	129	70	QTS100S-4100-DR03-ZYL40-MN	30650285

Konfigurierbare Merkmale

Längenausführung:
DR01 | DR03 | DR05 | DR08 |
DR10 | DR12

Spezifikation:
QTS100S-3500-[Längenausführung]-ZYL32-MN

Beispiel:
QTS100S-3500-DR10-ZYL32-MN

Längenausführung 10xD

Abmessungen konfigurierbare Baureihe

Haltergröße D	Durchmesserbereich Schneidplatte d ₁	d ₂ h ₆	l ₄	DR01		DR03		DR05		DR08		DR10		DR12		Spezifikation
				l ₁	l ₃	l ₁	l ₃	l ₁	l ₃	l ₁	l ₃	l ₁	l ₃	l ₁	l ₃	
9	9,00 - 9,49	12	45	77	15	92	29	110	48	138	76	-	-	-	-	QTS100S-0900-[Längenausführung]-ZYL12-MN
9,5	9,50 - 9,99	12	45	78	15	93	30	113	50	143	80	-	-	-	-	QTS100S-0950-[Längenausführung]-ZYL12-MN
10	10,00 - 10,49	16	48	83	16	99	32	120	53	151	84	-	-	-	-	QTS100S-1000-[Längenausführung]-ZYL16-MN
10,5	10,50 - 10,99	16	48	84	17	101	33	122	55	155	88	-	-	-	-	QTS100S-1050-[Längenausführung]-ZYL16-MN
11	11,00 - 11,49	16	48	86	18	103	35	126	58	160	92	-	-	-	-	QTS100S-1100-[Längenausführung]-ZYL16-MN
11,5	11,50 - 11,99	16	48	86	18	105	36	128	60	164	96	-	-	-	-	QTS100S-1150-[Längenausführung]-ZYL16-MN
12	12,00 - 12,49	16	48	88	19	107	38	132	63	169	100	-	-	-	-	QTS100S-1200-[Längenausführung]-ZYL16-MN
12,5	12,50 - 12,99	16	48	90	20	109	39	135	65	174	104	-	-	-	-	QTS100S-1250-[Längenausführung]-ZYL16-MN
13	13,00 - 13,49	16	48	91	21	112	41	138	68	178	108	205	135	232	162	QTS100S-1300-[Längenausführung]-ZYL16-MN
13,5	13,50 - 13,99	16	48	92	21	113	42	141	70	183	112	211	140	239	168	QTS100S-1350-[Längenausführung]-ZYL16-MN
14	14,00 - 14,49	16	48	93	22	116	44	144	73	187	116	216	145	245	174	QTS100S-1400-[Längenausführung]-ZYL16-MN
14,5	14,50 - 14,99	16	48	95	23	117	45	147	75	192	120	222	150	252	180	QTS100S-1450-[Längenausführung]-ZYL16-MN
15	15,00 - 15,99	20	50	99	24	124	48	155	80	203	128	237	162	267	192	QTS100S-1500-[Längenausführung]-ZYL20-MN
16	16,00 - 16,99	20	50	102	26	128	51	161	85	212	136	246	170	280	204	QTS100S-1600-[Längenausführung]-ZYL20-MN
17	17,00 - 17,99	20	50	105	27	132	54	168	90	222	144	258	180	294	216	QTS100S-1700-[Längenausführung]-ZYL20-MN
18	18,00 - 18,99	25	56	114	29	142	57	180	95	237	152	275	190	313	228	QTS100S-1800-[Längenausführung]-ZYL25-MN
19	19,00 - 19,99	25	56	116	30	146	60	186	100	246	160	286	200	326	240	QTS100S-1900-[Längenausführung]-ZYL25-MN
20	20,00 - 20,99	25	56	119	32	151	63	192	105	255	168	297	210	339	252	QTS100S-2000-[Längenausführung]-ZYL25-MN
21	21,00 - 21,99	25	56	121	33	155	66	198	110	264	176	308	220	352	264	QTS100S-2100-[Längenausführung]-ZYL25-MN
22	22,00 - 22,99	25	56	125	35	159	69	205	115	274	184	320	230	366	276	QTS100S-2200-[Längenausführung]-ZYL25-MN
23	23,00 - 23,99	25	56	127	36	163	72	211	120	283	192	331	240	379	288	QTS100S-2300-[Längenausführung]-ZYL25-MN
24	24,00 - 24,99	32	60	134	38	171	75	221	125	296	200	346	250	396	300	QTS100S-2400-[Längenausführung]-ZYL32-MN
25	25,00 - 25,99	32	60	136	39	176	78	227	130	305	208	357	260	409	312	QTS100S-2500-[Längenausführung]-ZYL32-MN
26	26,00 - 26,99	32	60	139	41	180	81	233	135	314	216	368	270	422	324	QTS100S-2600-[Längenausführung]-ZYL32-MN
27	27,00 - 27,99	32	60	142	42	184	84	240	140	324	224	380	280	436	336	QTS100S-2700-[Längenausführung]-ZYL32-MN

Abmessungen konfigurierbare Baureihe

Halte- größe D	Durchmesser- bereich Schneid- platte d ₁	d ₂ h ₆	l ₄	DR01		DR03		DR05		DR08		DR10		DR12		Spezifikation
				l ₁	l ₃	l ₁	l ₃	l ₁	l ₃	l ₁	l ₃	l ₁	l ₃	l ₁	l ₃	
28	28,00 - 28,99	32	60	145	44	188	87	246	145	333	232	391	290	449	348	QTS100S-2800-[Längenausführung]-ZYL32-MN
29	29,00 - 29,99	32	60	147	45	192	90	252	150	342	240	402	300	462	360	QTS100S-2900-[Längenausführung]-ZYL32-MN
30	30,00 - 30,99	32	60	150	47	197	93	258	155	351	248	413	310	475	372	QTS100S-3000-[Längenausführung]-ZYL32-MN
31	31,00 - 31,99	32	60	152	48	201	96	264	160	360	256	424	320	488	384	QTS100S-3100-[Längenausführung]-ZYL32-MN
32	32,00 - 32,99	32	60	156	50	205	99	271	165	370	264	436	330	502	396	QTS100S-3200-[Längenausführung]-ZYL32-MN
33	33,00 - 33,99	32	60	158	51	209	102	277	170	379	272	447	340	515	408	QTS100S-3300-[Längenausführung]-ZYL32-MN
34	34,00 - 34,99	32	60	161	53	213	105	283	175	388	280	458	350	528	420	QTS100S-3400-[Längenausführung]-ZYL32-MN
35	35,00 - 35,99	32	60	163	54	218	108	289	180	397	288	469	360	541	432	QTS100S-3500-[Längenausführung]-ZYL32-MN
36	36,00 - 36,99	32	60	166	56	222	111	295	185	406	296	480	370	554	444	QTS100S-3600-[Längenausführung]-ZYL32-MN
37	37,00 - 38,99	40	70	182	59	240	117	318	195	435	312	515	390	591	468	QTS100S-3700-[Längenausführung]-ZYL40-MN
39	39,00 - 40,99	40	70	187	62	249	123	330	205	453	328	537	410	617	492	QTS100S-3900-[Längenausführung]-ZYL40-MN
41	41,00 - 42,99	40	70	193	65	257	129	343	215	472	344	560	430	644	516	QTS100S-4100-[Längenausführung]-ZYL40-MN
43	43,00 - 44,99	40	70	198	68	265	135	355	225	490	360	582	440	670	540	QTS100S-4300-[Längenausführung]-ZYL40-MN
45	45,00 - 46,99	40	70	203	71	274	141	367	235	508	376	604	470	696	564	QTS100S-4500-[Längenausführung]-ZYL40-MN
47	47,00 - 48,99	40	70	211	74	284	147	382	245	529	392	627	490	725	588	QTS100S-4700-[Längenausführung]-ZYL40-MN
49	49,00 - 50,99	40	70	216	77	293	153	394	255	547	408	649	510	751	612	QTS100S-4900-[Längenausführung]-ZYL40-MN

Ersatzteile

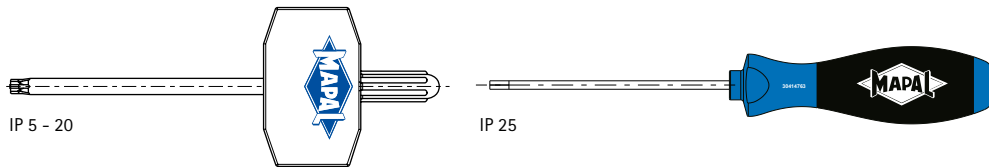

Schraubendreher

Torxgröße TORX PLUS®	Bestell-Nr.
5 IP	30584281
6 IP	30584282
7 IP	30584283
8 IP	30584284
9 IP	30584285
10 IP	30584286
15 IP	30584287
20 IP	30584288
25 IP	30414767

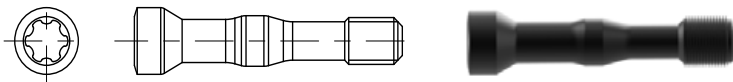

Spannschraube

Ø-Bereich	TORX PLUS® Größe	Bestell-Nr.	Spezifikation	Anzugsmoment [Nm]
8,00 - 8,99	5 IP	30604440	M1.2X7.5-TX5-IP	0,2
9,00 - 10,99	5 IP	30546309	M1.2X8.5-TX5-IP	0,2
11,00 - 12,99	6 IP	30604180	M1.6X10.5-TX6-IP	0,4
13,00 - 13,99	7 IP	30510826	M2x12-TX7-IP	0,6
14,00 - 15,99	8 IP	30510827	M2.2x13-TX8-IP	0,9
16,00 - 18,99	8 IP	30495432	M2.5x15-TX8-IP	1,2
19,00 - 21,99	9 IP	30510829	M3x18-TX9-IP	2,2
22,00 - 24,99	10 IP	30510830	M3.5x21-TX10-IP	3,3
25,00 - 27,99	15 IP	30510831	M4x24-TX15-IP	5,0
28,00 - 30,99	15 IP	30510832	M4.5x27-TX15-IP	5,7
31,00 - 32,99	20 IP	30510833	M5x30-TX20-IP	7,5
33,00 - 36,99	20 IP	30651830	M5X32-TX20-IP	7,5
37,00 - 44,99	25 IP	30651399	M6X35-TX25-IP	15,0
45,00 - 50,99	25 IP	30651510	M6X43-TX25-IP	15,0

Schnittwertempfehlung für Schneidplatten QTD

Vorschub und Schnittgeschwindigkeit

Typ 01 – Steel

MZG*	Werkstoff	Festigkeit/Härte [N/mm ²] [HRC]
P	P1.1 Bau-, Automaten-, Einsatz- und Vergütungsstähle, unlegiert	< 700
	P1.2 Bau-, Automaten-, Einsatz- und Vergütungsstähle, unlegiert	< 1.200
	P2.1 Nitrier-, Einsatz- und Vergütungsstähle, legiert	< 900
	P2.2 Nitrier-, Einsatz- und Vergütungsstähle, legiert	< 1.400
	P3.1 Werkzeug-, Wälzlager-, Feder- und Schnellarbeitsstähle**	< 800
	P3.2 Werkzeug-, Wälzlager-, Feder- und Schnellarbeitsstähle**	< 1.000
	P3.3 Werkzeug-, Wälzlager-, Feder- und Schnellarbeitsstähle**	< 1.500
P5	P5.1 Stahlguss	
K	K1.1 Gusseisen mit Lamellengraphit (Grauguss), GJL	< 300
	K2.1 Gusseisen mit Kugelgraphit, GJS	< 500
	K2.2 Gusseisen mit Kugelgraphit, GJS	≤ 800
	K2.3 Gusseisen mit Kugelgraphit, GJS	> 800
	K3.1 Gusseisen mit Vermiculargraphit, GJV; Temperguss, GJM	< 500
	K3.2 Gusseisen mit Vermiculargraphit, GJV; Temperguss, GJM	> 500

Typ 05 – Steel-Pyramid

MZG*	Werkstoff	Festigkeit/Härte [N/mm ²] [HRC]
P	P1.1 Bau-, Automaten-, Einsatz- und Vergütungsstähle, unlegiert	< 700
	P1.2 Bau-, Automaten-, Einsatz- und Vergütungsstähle, unlegiert	< 1.200
	P2.1 Nitrier-, Einsatz- und Vergütungsstähle, legiert	< 900
	P2.2 Nitrier-, Einsatz- und Vergütungsstähle, legiert	< 1.400
	P3.1 Werkzeug-, Wälzlager-, Feder- und Schnellarbeitsstähle**	< 800
	P3.2 Werkzeug-, Wälzlager-, Feder- und Schnellarbeitsstähle**	< 1.000
	P3.3 Werkzeug-, Wälzlager-, Feder- und Schnellarbeitsstähle**	< 1.500
K	K1.1 Gusseisen mit Lamellengraphit (Grauguss), GJL	< 300
	K2.1 Gusseisen mit Kugelgraphit, GJS	< 500
	K2.2 Gusseisen mit Kugelgraphit, GJS	≤ 800
	K2.3 Gusseisen mit Kugelgraphit, GJS	> 800

Typ 10 – Uni, Form EK

MZG*	Werkstoff	Festigkeit/Härte [N/mm ²] [HRC]
P	P1.1 Bau-, Automaten-, Einsatz- und Vergütungsstähle, unlegiert	< 700
	P1.2 Bau-, Automaten-, Einsatz- und Vergütungsstähle, unlegiert	< 1200
	P2.1 Nitrier-, Einsatz- und Vergütungsstähle, legiert	< 900
	P2.2 Nitrier-, Einsatz- und Vergütungsstähle, legiert	< 1400
	P3.1 Werkzeug-, Wälzlager-, Feder- und Schnellarbeitsstähle**	< 800
	P3.2 Werkzeug-, Wälzlager-, Feder- und Schnellarbeitsstähle**	< 1000
	P3.3 Werkzeug-, Wälzlager-, Feder- und Schnellarbeitsstähle**	< 1500
P5	P5.1 Stahlguss	
K	K1.1 Gusseisen mit Lamellengraphit (Grauguss), GJL	< 300
	K2.1 Gusseisen mit Kugelgraphit, GJS	< 500

* MAPAL Zerspanungsgruppen

** Wenn die Legierungsbestandteile Cr, Mo, Ni, V, W in Summe > 8 %, dann die nächst höhere MAPAL Zerspanungsgruppe wählen.

	Schnittgeschwindigkeit v_c [m/min]				Vorschub f [mm] bei Bohrerdurchmesser					
	Innenkühlung	Außenkühlung	MMS	Luft	8,00	11,50	16,50	24,00	34,50	50,00
	100	90	90		0,20	0,26	0,31	0,36	0,38	0,39
	90	75	75		0,25	0,32	0,39	0,45	0,47	0,49
	100	85	85		0,24	0,30	0,37	0,43	0,45	0,46
	70	60	60		0,19	0,24	0,29	0,34	0,35	0,36
	75	65	65		0,22	0,27	0,33	0,38	0,40	0,42
	60	55	55		0,18	0,22	0,27	0,31	0,33	0,34
	60	45	50		0,14	0,18	0,21	0,24	0,25	0,26
	100	85	85		0,24	0,30	0,37	0,43	0,45	0,46
	95	70	70	70	0,25	0,33	0,41	0,47	0,49	0,51
	130	80	95	95	0,24	0,30	0,37	0,43	0,46	0,47
	80	60	60		0,21	0,26	0,32	0,37	0,39	0,40
	50	30	40		0,14	0,18	0,21	0,24	0,26	0,26
	70	65	65		0,22	0,28	0,35	0,40	0,42	0,43
	65	55	55		0,18	0,23	0,27	0,32	0,33	0,34

	Schnittgeschwindigkeit v_c [m/min]				Vorschub f [mm] bei Bohrerdurchmesser					
	Innenkühlung	Außenkühlung	MMS	Luft	14,00	16,50	19,50	23,00	27,00	32,00
	120	110	110		0,26	0,29	0,31	0,33	0,34	0,34
	110	90	90		0,33	0,36	0,38	0,41	0,42	0,43
	120	100	100		0,31	0,34	0,36	0,38	0,40	0,41
	90	80	80		0,28	0,30	0,33	0,35	0,36	0,37
	95	70	70	70	0,39	0,43	0,46	0,49	0,51	0,52
	110	70	85	85	0,36	0,40	0,43	0,45	0,47	0,48

	Schnittgeschwindigkeit v_c [m/min]				Vorschub f [mm] bei Bohrerdurchmesser					
	Innenkühlung	Außenkühlung	MMS	Luft	10,00	13,00	16,00	21,00	26,00	33,00
	120	110	110		0,22	0,25	0,28	0,31	0,34	0,35
	110	90	90		0,27	0,31	0,35	0,39	0,42	0,43
	120	100	100		0,25	0,29	0,33	0,37	0,40	0,41
	90	80	80		0,23	0,26	0,30	0,33	0,36	0,37
	95	70	70	70	0,31	0,36	0,42	0,47	0,51	0,52
	110	70	85	85	0,29	0,34	0,39	0,43	0,47	0,48

Die angegebenen Schnittwerte sind Richtwerte.

Die für den jeweiligen Bearbeitungsfall optimalen Daten sollten im Versuch oder während der Bearbeitung ermittelt werden.

Schnittwertempfehlung für Schneidplatten QTD

Vorschub und Schnittgeschwindigkeit

Typ 02 – Inox

MZG*	Werkstoff	Festigkeit/Härte [N/mm ²] [HRC]
P	P1.1 Bau-, Automaten-, Einsatz- und Vergütungsstähle, unlegiert	< 700
	P1.2 Bau-, Automaten-, Einsatz- und Vergütungsstähle, unlegiert	< 1.200
	P2.1 Nitrier-, Einsatz- und Vergütungsstähle, legiert	< 900
	P2.2 Nitrier-, Einsatz- und Vergütungsstähle, legiert	< 1.400
	P3.1 Werkzeug-, Wälzlager-, Feder- und Schnellarbeitsstähle**	< 800
	P3.2 Werkzeug-, Wälzlager-, Feder- und Schnellarbeitsstähle**	< 1.000
	P3.3 Werkzeug-, Wälzlager-, Feder- und Schnellarbeitsstähle**	< 1.500
	P4.1 Rostfreie Stähle, ferritisch und martensitisch	
	P5.1 Stahlguss	
	P6.1 Rostfreier Stahlguss, ferritisch und martensitisch	
M	M1.1 Rostfreie Stähle, austenitisch	< 700
	M1.2 Rostfreie Stähle, ferritisch/austenitisch (Duplex)	< 1.000
	M2.1 Rostfreier Stahlguss, austenitisch	< 700
	M3.1 Rostfreier Stahlguss, ferritisch/austenitisch (Duplex)	< 1.000
K	K1.1 Gusseisen mit Lamellengraphit (Grauguss), GJL	< 300
	K2.1 Gusseisen mit Kugelgraphit, GJS	< 500
	K2.2 Gusseisen mit Kugelgraphit, GJS	≤ 800
	K2.3 Gusseisen mit Kugelgraphit, GJS	> 800
	K3.1 Gusseisen mit Vermiculargraphit, GJV; Temperguss, GJM	< 500
	K3.2 Gusseisen mit Vermiculargraphit, GJV; Temperguss, GJM	> 500

Typ 03 – Alu

MZG*	Werkstoff	Festigkeit/Härte [N/mm ²] [HRC]
N1	N1.1 Aluminium, unlegiert und legiert < 3 % Si	
	N1.2 Aluminium, legiert ≤ 7 % Si	
	N1.3 Aluminium, legiert > 7-12 % Si	
	N1.4 Aluminium, legiert > 12 % Si	
N2	N2.1 Kupfer, unlegiert und niedriglegiert	< 300
	N2.2 Kupfer, legiert	> 300
	N2.3 Messing, Bronze, Rotguss	< 1.200

Typ 04 – Iron

MZG*	Werkstoff	Festigkeit/Härte [N/mm ²] [HRC]
K	K1.1 Gusseisen mit Lamellengraphit (Grauguss), GJL	< 300
	K2.1 Gusseisen mit Kugelgraphit, GJS	< 500
	K2.2 Gusseisen mit Kugelgraphit, GJS	≤ 800
	K2.3 Gusseisen mit Kugelgraphit, GJS	> 800
	K3.1 Gusseisen mit Vermiculargraphit, GJV; Temperguss, GJM	< 500
	K3.2 Gusseisen mit Vermiculargraphit, GJV; Temperguss, GJM	> 500

* MAPAL Zerspanungsgruppen

** Wenn die Legierungsbestandteile Cr, Mo, Ni, V, W in Summe > 8 %, dann die nächst höhere MAPAL Zerspanungsgruppe wählen.

	Schnittgeschwindigkeit v_c [m/min]				Vorschub f [mm] bei Bohrerdurchmesser					
	Innenkühlung	Außenkühlung	MMS	Luft	9,00	12,00	16,00	21,00	27,50	36,00
	100	90	90		0,19	0,23	0,27	0,30	0,32	0,33
	90	75	75		0,24	0,29	0,34	0,38	0,40	0,41
	100	85	85		0,23	0,27	0,32	0,36	0,38	0,39
	70	60	60		0,18	0,22	0,25	0,28	0,30	0,31
	75	65	65		0,20	0,24	0,29	0,32	0,34	0,35
	60	55	55		0,17	0,20	0,23	0,26	0,28	0,29
	60	45	50		0,13	0,16	0,18	0,20	0,21	0,22
	60	45	50		0,13	0,16	0,19	0,21	0,23	0,23
	100	85	85		0,23	0,27	0,32	0,36	0,38	0,39
	60	45	50		0,13	0,16	0,19	0,21	0,23	0,23
	55	35	35		0,15	0,18	0,22	0,24	0,26	0,27
	50	30	30		0,13	0,16	0,19	0,21	0,22	0,23
	55	35	35		0,15	0,18	0,22	0,24	0,26	0,27
	50	30	30		0,13	0,16	0,19	0,21	0,22	0,23
	110	75	75	75	0,27	0,34	0,40	0,45	0,49	0,50
	145	90	110	110	0,26	0,31	0,37	0,42	0,45	0,46
	90	70	70		0,22	0,27	0,32	0,36	0,38	0,39
	55	35	45		0,15	0,18	0,21	0,23	0,25	0,26
	80	70	70		0,24	0,29	0,34	0,38	0,41	0,42
	70	65	65		0,19	0,23	0,27	0,30	0,33	0,33

	Schnittgeschwindigkeit v_c [m/min]				Vorschub f [mm] bei Bohrerdurchmesser					
	Innenkühlung	Außenkühlung	MMS	Luft	9,00	12,00	16,00	21,00	27,50	36,00
	300	200	250		0,19	0,23	0,27	0,30	0,32	0,33
	250	180	200		0,25	0,30	0,35	0,40	0,43	0,43
	220	150	180		0,25	0,30	0,35	0,40	0,43	0,43
	180	120	150		0,25	0,30	0,35	0,40	0,43	0,43
	140	100			0,19	0,23	0,27	0,30	0,32	0,33
	120	90			0,25	0,30	0,35	0,40	0,43	0,43
	200	160	160	120	0,30	0,37	0,44	0,50	0,54	0,55

	Schnittgeschwindigkeit v_c [m/min]				Vorschub f [mm] bei Bohrerdurchmesser					
	Innenkühlung	Außenkühlung	MMS	Luft	9,00	12,00	16,00	21,00	27,50	36,00
	120	85	85	85	0,37	0,45	0,53	0,60	0,65	0,66
	160	100	120	120	0,34	0,42	0,49	0,55	0,59	0,61
	100	75	75		0,30	0,36	0,42	0,48	0,51	0,52
	60	40	50		0,20	0,24	0,28	0,31	0,34	0,34
	90	80	80		0,32	0,39	0,46	0,51	0,55	0,56
	80	70	70		0,26	0,31	0,36	0,40	0,43	0,44

Die angegebenen Schnittwerte sind Richtwerte.

Die für den jeweiligen Bearbeitungsfall optimalen Daten sollten im Versuch oder während der Bearbeitung ermittelt werden.

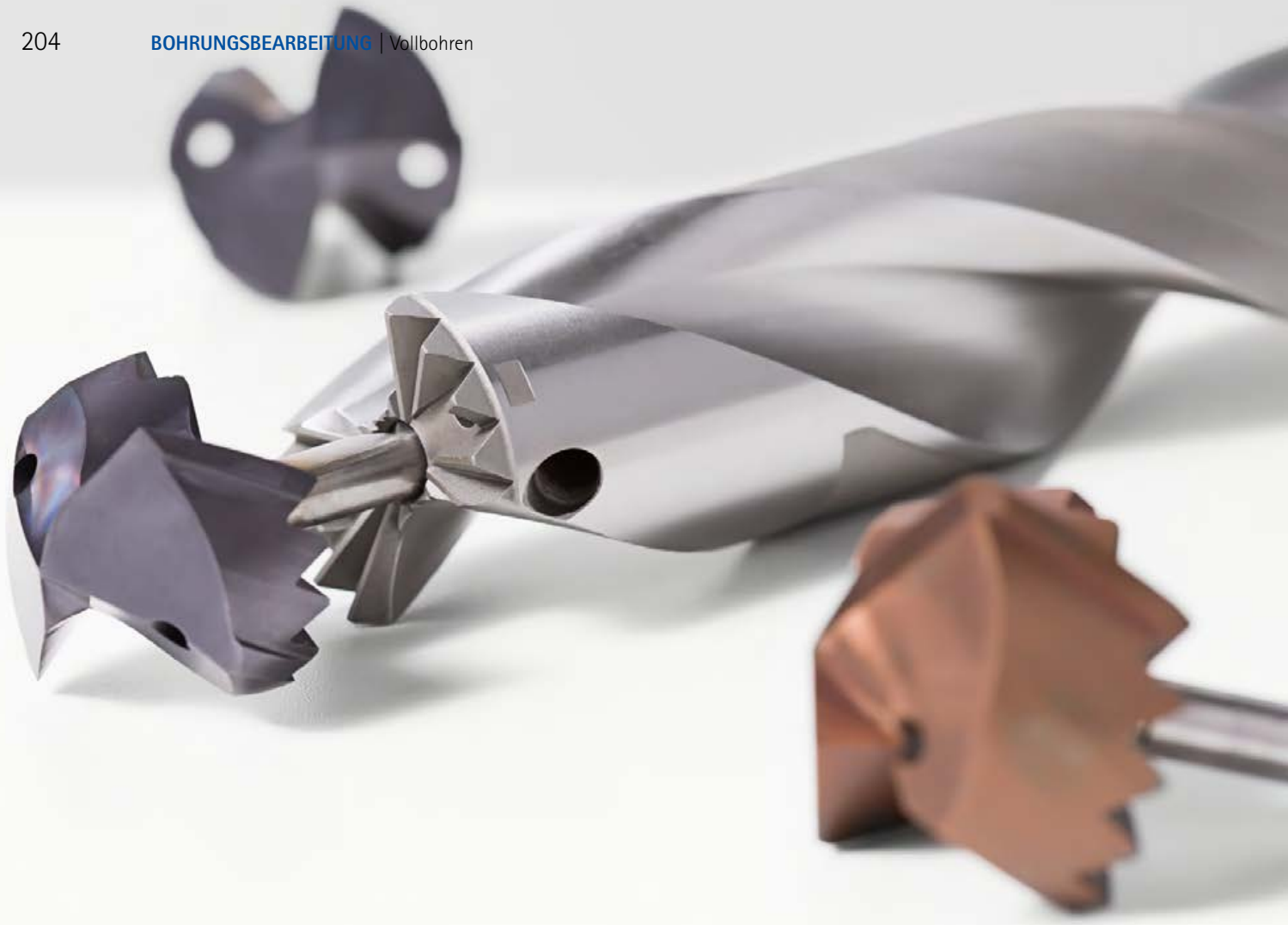

WECHSELKOPFBOHRER TTD

Minimierter Einsatz von Hartmetall bei höchster Stabilität & Präzision

Der Wechselkopfbohrer TTD erreicht das Leistungs- und Qualitätsniveau von Vollhartmetallbohrern. Gleichzeitig sorgt der auf die Wechselbohrköpfe reduzierte Einsatz des Hartmetalls für reduzierte Werkzeugkosten.

Im Mittelpunkt des Wechselkopfbohrers TTD steht die Trennstelle TTS (Torque Transfer System), die eine extrem stabile Verbindung garantiert. Sie ist gekennzeichnet durch eine opti-

male Drehmomentübertragung sowie hohe Wechsel- und Rundlaufgenauigkeiten.

Die Standardbaureihen des Wechselkopfbohrers TTD umfassen die Bohrtiefen 1xD, 3xD, 5xD, 8xD und 12xD. Mit fünf verschiedenen Wechselbohrköpfen werden auch problematische Bearbeitungsaufgaben in nahezu allen Werkstoffen im Durchmesserbereich von zwölf bis 45 mm abgedeckt.

Die Bohrköpfe weisen eine optimale Zentrierfähigkeit auf und die Späne werden durch den besonderen Facettenanschliff sicher über die Spanräume des TTS-Halters abgeleitet. Darüber hinaus wird ein sehr ruhiger Lauf in der Bohrung durch die Drei- bzw. Vierfasengeometrie begünstigt. Die Kombination dieser Eigenschaften ermöglicht hohe Standzeiten und Bohrergergebnisse auf höchstem Niveau.

Werkzeugfeatures im Detail

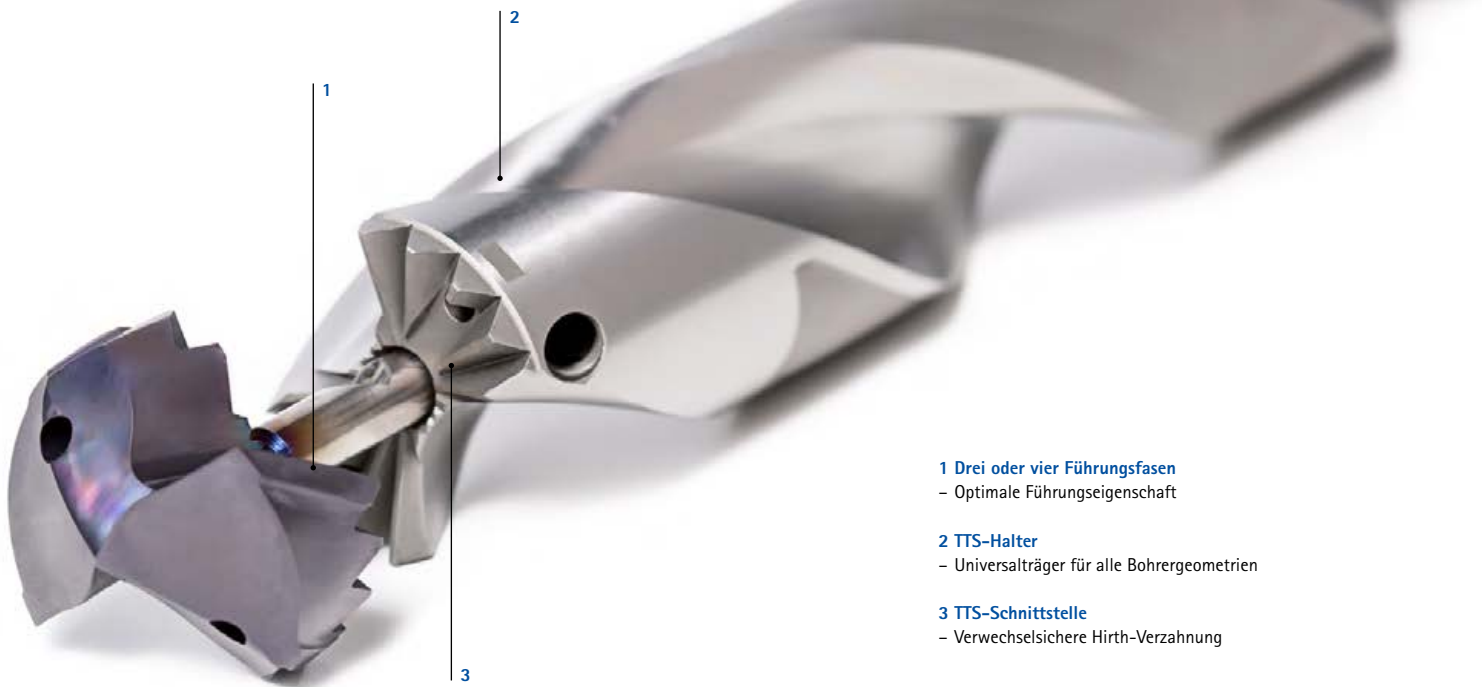

1 Drei oder vier Führungsfasen
– Optimale Führungseigenschaft

2 TTS-Halter
– Universalträger für alle Bohrergeometrien

3 TTS-Schnittstelle
– Verwechselfsichere Hirth-Verzahnung



AUF EINEN BLICK

- Ab Lager verfügbar
- ϕ -Bereich 12,00 bis 45,00 mm
- Bohrtiefen 1 | 3 | 5 | 8 und 12xD
- Mit Innenkühlung
- Einfaches Handling
- Kopfwechsel in der Maschine möglich

LEISTUNGSMERKMALE

- Gleiche Leistungsfähigkeit wie VHM-Bohrer
- Hohe Rundlaufgenauigkeit
- Gute Positionsgenauigkeit
- Hohe Drehmomentübertragung

VORTEILE

- Bei Bedarf nachschleifbar
- Verwechslungssicherer Kopfwechsel
- Ein Wechselkopfhalter für unterschiedliche Bohrköpfe
- Nahezu alle Bohrgeometrien realisierbar

Wechselbohrkopf TTD

Aus Vollhartmetall, innere Kühlmittelzufuhr
Typ 01P - Uni-Plus

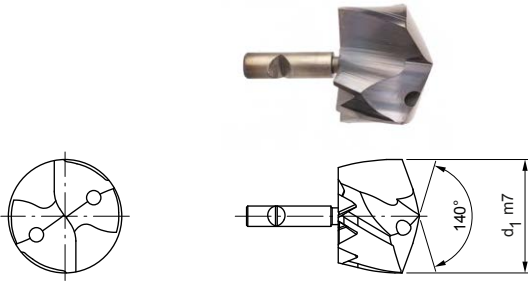

Ausführung:

Bohrerdurchmesser: 12,00 – 45,00 mm
Bohrungstoleranz: ≥ IT 9
Schneidstoff: HP358
Schneidenanzahl: 2
Anzahl Führungsfasen: 4
Spitzenwinkel: 140°



Lagerhaltige Vorzugsbaureihe

d ₁ von 12,00 bis 21,00		
d ₁ m7	Spezifikation	Bestell-Nr.
12,00	TTD-4F01P-1200-HP358	31164086
13,50	TTD-4F01P-1350-HP358	31164141
14,00	TTD-4F01P-1400-HP358	31164146
14,50	TTD-4F01P-1450-HP358	31164151
15,00	TTD-4F01P-1500-HP358	31164156
15,50	TTD-4F01P-1550-HP358	31164161
15,60	TTD-4F01P-1560-HP358	31164162
15,80	TTD-4F01P-1580-HP358	31164164
16,00	TTD-4F01P-1600-HP358	31164166
16,50	TTD-4F01P-1650-HP358	31164171
17,00	TTD-4F01P-1700-HP358	31164176
17,50	TTD-4F01P-1750-HP358	31164181
17,70	TTD-4F01P-1770-HP358	31164183
17,80	TTD-4F01P-1780-HP358	31164184
18,00	TTD-4F01P-1800-HP358	31164186
18,50	TTD-4F01P-1850-HP358	31164191
18,80	TTD-4F01P-1880-HP358	31164194
19,00	TTD-4F01P-1900-HP358	31164196
19,50	TTD-4F01P-1950-HP358	31164201
19,70	TTD-4F01P-1970-HP358	31164203
20,00	TTD-4F01P-2000-HP358	31164206
20,50	TTD-4F01P-2050-HP358	31164211
21,00	TTD-4F01P-2100-HP358	31164216

d ₁ von 21,50 bis 40,00		
d ₁ m7	Spezifikation	Bestell-Nr.
21,50	TTD-4F01P-2150-HP358	31164221
22,00	TTD-4F01P-2200-HP358	31164226
22,50	TTD-4F01P-2250-HP358	31164231
23,00	TTD-4F01P-2300-HP358	31164236
24,00	TTD-4F01P-2400-HP358	31164246
24,50	TTD-4F01P-2450-HP358	31164251
25,00	TTD-4F01P-2500-HP358	31164256
25,40	TTD-4F01P-2540-HP358	31164260
25,50	TTD-4F01P-2550-HP358	31164261
26,00	TTD-4F01P-2600-HP358	31164266
26,50	TTD-4F01P-2650-HP358	31164271
27,00	TTD-4F01P-2700-HP358	31164276
28,00	TTD-4F01P-2800-HP358	31164286
28,50	TTD-4F01P-2850-HP358	31164291
30,00	TTD-4F01P-3000-HP358	31164306
30,70	TTD-4F01P-3070-HP358	31164313
31,00	TTD-4F01P-3100-HP358	31164316
32,00	TTD-4F01P-3200-HP358	31164326
33,00	TTD-4F01P-3300-HP358	31164328
37,00	TTD-4F01P-3700-HP358	31164336
38,50	TTD-4F01P-3850-HP358	31164339
39,00	TTD-4F01P-3900-HP358	31164340
40,00	TTD-4F01P-4000-HP358	31164342

Konfigurierbare Merkmale



Durchmesser:
Durchmesser in Abstufungen von 0,01 mm frei wählbar

Spezifikation:
TTD-4F01P-[Durchmesser]-HP358

Abmessungen konfigurierbare Baureihe

d ₁ min.	d ₁ max.
12,00	45,00

Beispiel:
TTD-4F01P-1401-HP358

Werkzeughdurchmesser d₁ = 14,01 mm

Maßangaben in mm.
Sonderausführungen auf Anfrage.

Wechselbohrkopf TTD

Aus Vollhartmetall, innere Kühlmittelzufuhr
Typ 04 - Steel

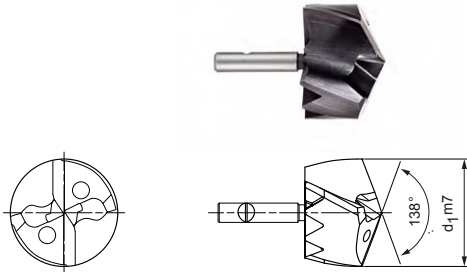

Ausführung:

Bohrerdurchmesser:	12,00 – 45,00 mm
Bohrungstoleranz:	≥ IT 9
Schneidstoff:	HP358
Schneidenanzahl:	2
Anzahl Führungsfasen:	3
Spitzenwinkel:	138°



Lagerhaltige Vorzugsbaureihe

d ₁ von 12,00 bis 17,00		
d ₁ m7	Spezifikation	Bestell-Nr.
12,00	TTD-3F04-1200-HP358	30530406
12,10	TTD-3F04-1210-HP358	30596953
12,20	TTD-3F04-1220-HP358	30596954
12,50	TTD-3F04-1250-HP358	30530407
12,80	TTD-3F04-1280-HP358	30596958
13,00	TTD-3F04-1300-HP358	30530409
13,10	TTD-3F04-1310-HP358	30596960
13,20	TTD-3F04-1320-HP358	30596961
13,50	TTD-3F04-1350-HP358	30530410
14,00	TTD-3F04-1400-HP358	30530412
14,10	TTD-3F04-1410-HP358	30596967
14,20	TTD-3F04-1420-HP358	30596968
14,30	TTD-3F04-1430-HP358	30596969
14,40	TTD-3F04-1440-HP358	30596970
14,50	TTD-3F04-1450-HP358	30530413
14,70	TTD-3F04-1470-HP358	30530414
14,80	TTD-3F04-1480-HP358	30596972
15,00	TTD-3F04-1500-HP358	30530415
15,10	TTD-3F04-1510-HP358	30596974
15,20	TTD-3F04-1520-HP358	30596975
15,50	TTD-3F04-1550-HP358	30530416
15,70	TTD-3F04-1570-HP358	30530417
15,80	TTD-3F04-1580-HP358	30596979
16,00	TTD-3F04-1600-HP358	30530418
16,10	TTD-3F04-1610-HP358	30596981
16,20	TTD-3F04-1620-HP358	30596982
16,30	TTD-3F04-1630-HP358	30596983
16,40	TTD-3F04-1640-HP358	30596984
16,50	TTD-3F04-1650-HP358	30530419
16,60	TTD-3F04-1660-HP358	30596985
16,70	TTD-3F04-1670-HP358	30530420
16,80	TTD-3F04-1680-HP358	30596986
17,00	TTD-3F04-1700-HP358	30530421

d ₁ von 17,10 bis 21,40		
d ₁ m7	Spezifikation	Bestell-Nr.
17,10	TTD-3F04-1710-HP358	30596988
17,30	TTD-3F04-1730-HP358	30596990
17,50	TTD-3F04-1750-HP358	30530422
17,60	TTD-3F04-1760-HP358	30596992
17,70	TTD-3F04-1770-HP358	30530423
17,80	TTD-3F04-1780-HP358	30596993
18,00	TTD-3F04-1800-HP358	30530424
18,10	TTD-3F04-1810-HP358	30596995
18,20	TTD-3F04-1820-HP358	30596996
18,30	TTD-3F04-1830-HP358	30596997
18,40	TTD-3F04-1840-HP358	30596998
18,50	TTD-3F04-1850-HP358	30530425
18,80	TTD-3F04-1880-HP358	30597000
18,90	TTD-3F04-1890-HP358	30597001
19,00	TTD-3F04-1900-HP358	30530427
19,20	TTD-3F04-1920-HP358	30597003
19,30	TTD-3F04-1930-HP358	30597004
19,50	TTD-3F04-1950-HP358	30530428
19,70	TTD-3F04-1970-HP358	30530429
19,80	TTD-3F04-1980-HP358	30597007
19,90	TTD-3F04-1990-HP358	30597008
20,00	TTD-3F04-2000-HP358	30530431
20,10	TTD-3F04-2010-HP358	30597009
20,20	TTD-3F04-2020-HP358	30597010
20,30	TTD-3F04-2030-HP358	30597011
20,40	TTD-3F04-2040-HP358	30597012
20,50	TTD-3F04-2050-HP358	30530432
20,60	TTD-3F04-2060-HP358	30597013
20,70	TTD-3F04-2070-HP358	30530433
21,00	TTD-3F04-2100-HP358	30530434
21,10	TTD-3F04-2110-HP358	30597016
21,20	TTD-3F04-2120-HP358	30597017
21,40	TTD-3F04-2140-HP358	30597019

Fortsetzung auf nächster Seite.

Wechselbohrkopf TTD aus Vollhartmetall, innere Kühlmittelzufuhr – Typ 04

d ₁ von 21,50 bis 26,10			d ₁ von 26,20 bis 41,00		
d ₁ m7	Spezifikation	Bestell-Nr.	d ₁ m7	Spezifikation	Bestell-Nr.
21,50	TTD-3F04-2150-HP358	30530435	26,20	TTD-3F04-2620-HP358	30597052
21,70	TTD-3F04-2170-HP358	30530436	26,50	TTD-3F04-2650-HP358	30530450
21,80	TTD-3F04-2180-HP358	30597021	26,70	TTD-3F04-2670-HP358	30530451
22,00	TTD-3F04-2200-HP358	30530437	27,00	TTD-3F04-2700-HP358	30530452
22,10	TTD-3F04-2210-HP358	30597023	27,50	TTD-3F04-2750-HP358	30530453
22,20	TTD-3F04-2220-HP358	30597024	27,70	TTD-3F04-2770-HP358	30530454
22,30	TTD-3F04-2230-HP358	30597025	27,80	TTD-3F04-2780-HP358	30597063
22,40	TTD-3F04-2240-HP358	30597026	28,00	TTD-3F04-2800-HP358	30530455
22,50	TTD-3F04-2250-HP358	30530438	28,20	TTD-3F04-2820-HP358	30597066
22,60	TTD-3F04-2260-HP358	30597027	28,30	TTD-3F04-2830-HP358	30597067
22,70	TTD-3F04-2270-HP358	30530439	28,50	TTD-3F04-2850-HP358	30530456
23,00	TTD-3F04-2300-HP358	30530440	29,00	TTD-3F04-2900-HP358	30530458
23,10	TTD-3F04-2310-HP358	30597030	30,00	TTD-3F04-3000-HP358	30530461
23,30	TTD-3F04-2330-HP358	30597032	30,30	TTD-3F04-3030-HP358	30597082
23,50	TTD-3F04-2350-HP358	30530441	30,50	TTD-3F04-3050-HP358	30530462
23,70	TTD-3F04-2370-HP358	30530442	31,00	TTD-3F04-3100-HP358	30530464
24,00	TTD-3F04-2400-HP358	30530443	31,50	TTD-3F04-3150-HP358	30530465
24,40	TTD-3F04-2440-HP358	30597040	31,70	TTD-3F04-3170-HP358	30530466
24,50	TTD-3F04-2450-HP358	30530444	32,00	TTD-3F04-3200-HP358	30530467
24,70	TTD-3F04-2470-HP358	30530445	33,00	TTD-3F04-3300-HP358	30530469
24,80	TTD-3F04-2480-HP358	30597042	34,00	TTD-3F04-3400-HP358	30530471
25,00	TTD-3F04-2500-HP358	30530446	34,50	TTD-3F04-3450-HP358	30530472
25,20	TTD-3F04-2520-HP358	30597045	35,00	TTD-3F04-3500-HP358	30530473
25,30	TTD-3F04-2530-HP358	30597046	36,00	TTD-3F04-3600-HP358	30530475
25,40	TTD-3F04-2540-HP358	30597047	37,00	TTD-3F04-3700-HP358	30530477
25,50	TTD-3F04-2550-HP358	30530447	38,00	TTD-3F04-3800-HP358	30530479
25,90	TTD-3F04-2590-HP358	30597050	39,00	TTD-3F04-3900-HP358	30530481
26,00	TTD-3F04-2600-HP358	30530449	40,00	TTD-3F04-4000-HP358	30530483
26,10	TTD-3F04-2610-HP358	30597051	41,00	TTD-3F04-4100-HP358	30530485

Konfigurierbare Merkmale



Durchmesser:
Durchmesser in Abstufungen
von 0,01 mm frei wählbar



Spezifikation:

TTD-3F04-[Durchmesser]-HP358

Abmessungen konfigurierbare Baureihe

d ₁ min.	d ₁ max.
12,00	45,00

Beispiel:

TTD-3F04-1401-HP358

Werkzeugdurchmesser d₁ = 14,01 mm

Wechselbohrkopf TTD

Aus Vollhartmetall, innere Kühlmittelzufuhr
Typ 02 - Inox

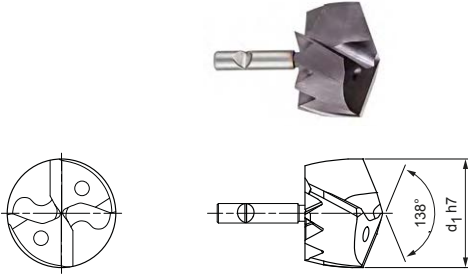

Ausführung:

Bohrerdurchmesser: 12,00 – 45,00 mm
Bohrungstoleranz: $\geq IT 9$
Schneidstoff: HP385
Schneidenanzahl: 2
Anzahl Führungsfasen: 3
Spitzenwinkel: 138°



Lagerhaltige Vorzugsbaureihe

d ₁ von 12,00 bis 16,40		
d ₁ h7	Spezifikation	Bestell-Nr.
12,00	TTD-3F02-1200-HP385	30231780
12,10	TTD-3F02-1210-HP385	30248920
12,20	TTD-3F02-1220-HP385	30248921
12,40	TTD-3F02-1240-HP385	30248923
12,50	TTD-3F02-1250-HP385	30231784
12,60	TTD-3F02-1260-HP385	30248924
12,70	TTD-3F02-1270-HP385	30231787
13,00	TTD-3F02-1300-HP385	30231791
13,10	TTD-3F02-1310-HP385	30248927
13,50	TTD-3F02-1350-HP385	30231792
13,80	TTD-3F02-1380-HP385	30248932
14,00	TTD-3F02-1400-HP385	30231795
14,10	TTD-3F02-1410-HP385	30239446
14,20	TTD-3F02-1420-HP385	30248934
14,30	TTD-3F02-1430-HP385	30248935
14,40	TTD-3F02-1440-HP385	30248936
14,50	TTD-3F02-1450-HP385	30231802
14,60	TTD-3F02-1460-HP385	30248937
14,70	TTD-3F02-1470-HP385	30231804
14,80	TTD-3F02-1480-HP385	30248938
15,00	TTD-3F02-1500-HP385	30231805
15,10	TTD-3F02-1510-HP385	30248940
15,30	TTD-3F02-1530-HP385	30248942
15,50	TTD-3F02-1550-HP385	30231806
15,60	TTD-3F02-1560-HP385	30248944
15,70	TTD-3F02-1570-HP385	30219115
15,80	TTD-3F02-1580-HP385	30248945
15,90	TTD-3F02-1590-HP385	30248946
16,00	TTD-3F02-1600-HP385	30191427
16,10	TTD-3F02-1610-HP385	30248947
16,20	TTD-3F02-1620-HP385	30248948
16,30	TTD-3F02-1630-HP385	30248949
16,40	TTD-3F02-1640-HP385	30248950

d ₁ von 16,50 bis 21,00		
d ₁ h7	Spezifikation	Bestell-Nr.
16,50	TTD-3F02-1650-HP385	30191428
16,60	TTD-3F02-1660-HP385	30248951
16,70	TTD-3F02-1670-HP385	30219122
16,80	TTD-3F02-1680-HP385	30248952
17,00	TTD-3F02-1700-HP385	30191429
17,50	TTD-3F02-1750-HP385	30191430
17,60	TTD-3F02-1760-HP385	30248958
17,70	TTD-3F02-1770-HP385	30219123
17,80	TTD-3F02-1780-HP385	30248959
18,00	TTD-3F02-1800-HP385	30191431
18,20	TTD-3F02-1820-HP385	30248962
18,30	TTD-3F02-1830-HP385	30248963
18,50	TTD-3F02-1850-HP385	30191432
18,60	TTD-3F02-1860-HP385	30248965
18,80	TTD-3F02-1880-HP385	30248966
18,90	TTD-3F02-1890-HP385	30248967
19,00	TTD-3F02-1900-HP385	30191433
19,10	TTD-3F02-1910-HP385	30248968
19,20	TTD-3F02-1920-HP385	30248969
19,30	TTD-3F02-1930-HP385	30248970
19,40	TTD-3F02-1940-HP385	30248971
19,50	TTD-3F02-1950-HP385	30191434
19,70	TTD-3F02-1970-HP385	30219125
19,80	TTD-3F02-1980-HP385	30248973
19,90	TTD-3F02-1990-HP385	30248974
20,00	TTD-3F02-2000-HP385	30191435
20,10	TTD-3F02-2010-HP385	30248975
20,20	TTD-3F02-2020-HP385	30248976
20,30	TTD-3F02-2030-HP385	30248977
20,40	TTD-3F02-2040-HP385	30248978
20,50	TTD-3F02-2050-HP385	30191436
20,70	TTD-3F02-2070-HP385	30219126
21,00	TTD-3F02-2100-HP385	30191437

Fortsetzung auf nächster Seite.

Wechselbohrkopf TTD aus Vollhartmetall, innere Kühlmittelzufuhr – Typ O2

d ₁ von 21,20 bis 25,80			d ₁ von 26,00 bis 38,50		
d ₁ h7	Spezifikation	Bestell-Nr.	d ₁ h7	Spezifikation	Bestell-Nr.
21,20	TTD-3F02-2120-HP385	30248982	26,00	TTD-3F02-2600-HP385	30191447
21,50	TTD-3F02-2150-HP385	30191438	26,50	TTD-3F02-2650-HP385	30191448
21,70	TTD-3F02-2170-HP385	30219127	26,80	TTD-3F02-2680-HP385	30249020
21,80	TTD-3F02-2180-HP385	30248986	27,00	TTD-3F02-2700-HP385	30191449
22,00	TTD-3F02-2200-HP385	30191439	27,10	TTD-3F02-2710-HP385	30249022
22,10	TTD-3F02-2210-HP385	30248988	27,40	TTD-3F02-2740-HP385	30249025
22,40	TTD-3F02-2240-HP385	30248990	27,50	TTD-3F02-2750-HP385	30191450
22,50	TTD-3F02-2250-HP385	30191440	28,00	TTD-3F02-2800-HP385	30191451
22,60	TTD-3F02-2260-HP385	30248991	28,10	TTD-3F02-2810-HP385	30249029
22,70	TTD-3F02-2270-HP385	30219128	28,20	TTD-3F02-2820-HP385	30249030
22,80	TTD-3F02-2280-HP385	30248992	28,50	TTD-3F02-2850-HP385	30191452
22,90	TTD-3F02-2290-HP385	30248993	28,60	TTD-3F02-2860-HP385	30249033
23,00	TTD-3F02-2300-HP385	30191441	28,70	TTD-3F02-2870-HP385	30219134
23,50	TTD-3F02-2350-HP385	30191442	29,00	TTD-3F02-2900-HP385	30191453
23,70	TTD-3F02-2370-HP385	30219129	29,50	TTD-3F02-2950-HP385	30191454
24,00	TTD-3F02-2400-HP385	30191443	29,70	TTD-3F02-2970-HP385	30219135
24,20	TTD-3F02-2420-HP385	30249002	29,80	TTD-3F02-2980-HP385	30249041
24,40	TTD-3F02-2440-HP385	30249004	29,90	TTD-3F02-2990-HP385	30249042
24,50	TTD-3F02-2450-HP385	30191444	30,00	TTD-3F02-3000-HP385	30191455
24,70	TTD-3F02-2470-HP385	30219130	30,10	TTD-3F02-3010-HP385	30249043
24,80	TTD-3F02-2480-HP385	30249006	30,30	TTD-3F02-3030-HP385	30249045
25,00	TTD-3F02-2500-HP385	30191445	31,00	TTD-3F02-3100-HP385	30191457
25,20	TTD-3F02-2520-HP385	30249009	31,30	TTD-3F02-3130-HP385	30249052
25,30	TTD-3F02-2530-HP385	30249010	31,50	TTD-3F02-3150-HP385	30191458
25,40	TTD-3F02-2540-HP385	30249011	31,80	TTD-3F02-3180-HP385	30249055
25,50	TTD-3F02-2550-HP385	30191446	32,00	TTD-3F02-3200-HP385	30191459
25,70	TTD-3F02-2570-HP385	30219131	38,50	TTD-3F02-3850-HP385	30322384
25,80	TTD-3F02-2580-HP385	30249013			

Konfigurierbare Merkmale



Durchmesser:
Durchmesser in Abstufungen
von 0,01 mm frei wählbar



Spezifikation:

TTD-3F02-[Durchmesser]-HP358

Abmessungen konfigurierbare Baureihe

d ₁ min.	d ₁ max.
12,00	45,00

Beispiel:

TTD-3F02-1401-HP358

Werkzeugdurchmesser d₁ = 14,01 mm

Maßangaben in mm.

Schnittwertempfehlung siehe Kapitelende.

Sonderausführungen und andere Beschichtungen auf Anfrage.

Wechselbohrkopf TTD

Aus Vollhartmetall, innere Kühlmittelzufuhr
Typ 05 - Iron

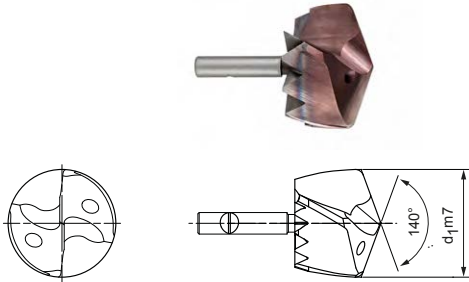

Ausführung:

Bohrerdurchmesser: 12,00 – 45,00 mm
Bohrungstoleranz: \geq IT 9
Schneidstoff: HP240
Schneidenanzahl: 2
Anzahl Führungsfasen: 4
Spitzenwinkel: 140°



Lagerhaltige Vorzugsbaureihe

d ₁ von 12,50 bis 20,80		
d ₁ m7	Spezifikation	Bestell-Nr.
12,50	TTD-4F05-1250-HP240	30597144
12,70	TTD-4F05-1270-HP240	30597146
14,00	TTD-4F05-1400-HP240	30597159
14,50	TTD-4F05-1450-HP240	30597164
15,30	TTD-4F05-1530-HP240	30597173
15,70	TTD-4F05-1570-HP240	30597177
16,30	TTD-4F05-1630-HP240	30597183
16,50	TTD-4F05-1650-HP240	30597185
16,70	TTD-4F05-1670-HP240	30597187
16,80	TTD-4F05-1680-HP240	30597188
17,00	TTD-4F05-1700-HP240	30597190
17,10	TTD-4F05-1710-HP240	30597191
17,50	TTD-4F05-1750-HP240	30597195
18,00	TTD-4F05-1800-HP240	30597200
18,20	TTD-4F05-1820-HP240	30597202
18,50	TTD-4F05-1850-HP240	30597205
18,60	TTD-4F05-1860-HP240	30597206
18,80	TTD-4F05-1880-HP240	30597208
19,00	TTD-4F05-1900-HP240	30597210
19,70	TTD-4F05-1970-HP240	30597217
20,50	TTD-4F05-2050-HP240	30597225
20,70	TTD-4F05-2070-HP240	30597227
20,80	TTD-4F05-2080-HP240	30597228

d ₁ von 21,00 bis 37,00		
d ₁ m7	Spezifikation	Bestell-Nr.
21,00	TTD-4F05-2100-HP240	30597230
21,10	TTD-4F05-2110-HP240	30597231
21,50	TTD-4F05-2150-HP240	30597235
21,70	TTD-4F05-2170-HP240	30597237
22,00	TTD-4F05-2200-HP240	30597240
22,10	TTD-4F05-2210-HP240	30597241
22,30	TTD-4F05-2230-HP240	30597243
22,70	TTD-4F05-2270-HP240	30597247
23,00	TTD-4F05-2300-HP240	30597250
23,50	TTD-4F05-2350-HP240	30597255
24,00	TTD-4F05-2400-HP240	30597260
24,40	TTD-4F05-2440-HP240	30597264
24,80	TTD-4F05-2480-HP240	30597268
25,00	TTD-4F05-2500-HP240	30597270
25,80	TTD-4F05-2580-HP240	30597278
26,00	TTD-4F05-2600-HP240	30597280
27,00	TTD-4F05-2700-HP240	30597290
27,10	TTD-4F05-2710-HP240	30597291
28,00	TTD-4F05-2800-HP240	30597300
28,50	TTD-4F05-2850-HP240	30597305
30,00	TTD-4F05-3000-HP240	30597320
32,00	TTD-4F05-3200-HP240	30597341
37,00	TTD-4F05-3700-HP240	30597351

Konfigurierbare Merkmale



Durchmesser:
Durchmesser in Abstufungen
von 0,01 mm frei wählbar



Spezifikation:

TTD-4F05-[Durchmesser]-HP240

Abmessungen konfigurierbare Baureihe

d ₁ min.	d ₁ max.
12,00	45,00

Beispiel:

TTD-4F05-1401-HP619

Werkzeugdurchmesser d₁ = 14,01 mm

Maßangaben in mm.

Schnittwertempfehlung siehe Kapitelende.

Sonderausführungen und andere Beschichtungen auf Anfrage.

Wechselbohrkopf TTD

Aus Vollhartmetall, innere Kühlmittelzufuhr
Typ 03 - Alu

Ausführung:
Bohrerdurchmesser: 12,00 – 45,00 mm
Bohrungstoleranz: ≥ IT 9
Schneidstoff: HP685
Schneidenanzahl: 2
Anzahl Führungsfasen: 4
Spitzenwinkel: 140°

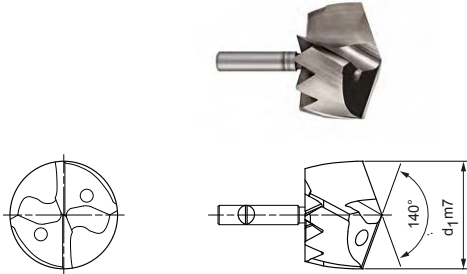

Lagerhaltige Vorzugsbaureihe

d ₁ von 12,10 bis 21,00		
d ₁ m7	Spezifikation	Bestell-Nr.
12,10	TTD-4F03-1210-HP685	30249057
12,50	TTD-4F03-1250-HP685	30231808
12,80	TTD-4F03-1280-HP685	30249062
13,00	TTD-4F03-1300-HP685	30231812
13,50	TTD-4F03-1350-HP685	30231815
14,00	TTD-4F03-1400-HP685	30231817
14,50	TTD-4F03-1450-HP685	30231818
14,70	TTD-4F03-1470-HP685	30231819
14,90	TTD-4F03-1490-HP685	30249077
15,00	TTD-4F03-1500-HP685	30231820
16,00	TTD-4F03-1600-HP685	30191460
16,10	TTD-4F03-1610-HP685	30249085
16,50	TTD-4F03-1650-HP685	30191461
17,00	TTD-4F03-1700-HP685	30191462
17,50	TTD-4F03-1750-HP685	30191463
18,00	TTD-4F03-1800-HP685	30191464
18,10	TTD-4F03-1810-HP685	30234210
18,20	TTD-4F03-1820-HP685	30249099
18,30	TTD-4F03-1830-HP685	30249100
18,50	TTD-4F03-1850-HP685	30191465
18,60	TTD-4F03-1860-HP685	30249102
18,70	TTD-4F03-1870-HP685	30219141
19,00	TTD-4F03-1900-HP685	30191466
19,50	TTD-4F03-1950-HP685	30191467
19,60	TTD-4F03-1960-HP685	30249109
20,00	TTD-4F03-2000-HP685	30191468
20,30	TTD-4F03-2030-HP685	30216431
20,50	TTD-4F03-2050-HP685	30191469
21,00	TTD-4F03-2100-HP685	30191470

d ₁ von 21,50 bis 43,00		
d ₁ m7	Spezifikation	Bestell-Nr.
21,50	TTD-4F03-2150-HP685	30191471
22,00	TTD-4F03-2200-HP685	30191472
22,50	TTD-4F03-2250-HP685	30191473
22,60	TTD-4F03-2260-HP685	30249129
23,00	TTD-4F03-2300-HP685	30191474
23,50	TTD-4F03-2350-HP685	30191475
23,90	TTD-4F03-2390-HP685	30249138
24,00	TTD-4F03-2400-HP685	30191476
24,10	TTD-4F03-2410-HP685	30249139
24,40	TTD-4F03-2440-HP685	30249142
24,50	TTD-4F03-2450-HP685	30191477
25,00	TTD-4F03-2500-HP685	30191478
25,10	TTD-4F03-2510-HP685	30249146
25,20	TTD-4F03-2520-HP685	30249147
25,50	TTD-4F03-2550-HP685	30191479
26,00	TTD-4F03-2600-HP685	30191480
26,40	TTD-4F03-2640-HP685	30249156
27,00	TTD-4F03-2700-HP685	30191482
27,50	TTD-4F03-2750-HP685	30191483
28,00	TTD-4F03-2800-HP685	30191484
28,30	TTD-4F03-2830-HP685	30249169
28,40	TTD-4F03-2840-HP685	30249170
29,50	TTD-4F03-2950-HP685	30191487
31,00	TTD-4F03-3100-HP685	30191490
31,20	TTD-4F03-3120-HP685	30249189
32,00	TTD-4F03-3200-HP685	30191492
35,00	TTD-4F03-3500-HP685	30322405
43,00	TTD-4F03-4300-HP685	30322423

Konfigurierbare Merkmale



Durchmesser:
Durchmesser in Abstufungen von 0,01 mm frei wählbar



Spezifikation:
TTD-4F03-[Durchmesser]-HP685

Abmessungen konfigurierbare Baureihe

d ₁ min.	d ₁ max.
12.00	45.00

Beispiel:
TTD-4F03-1401-HP685

Werkzeugdurchmesser d₁ = 14.01 mm

Maßangaben in mm.
Schnittwertempfehlung siehe Kapitelende.
Sonderausführungen und andere Beschichtungen auf Anfrage.

Wechselkopfhalter TTS

Mit Frontspannsystem für Wechselkopfbohrer TTD
TTS100, innere Kühlmittelzufuhr

Ausführung:

Für Bohrer Durchmesser: 12,00 - 45,49 mm
Wechselsystem: System-Frontspannung
Kopfwechsel auf der Maschine möglich

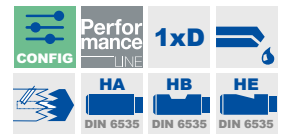
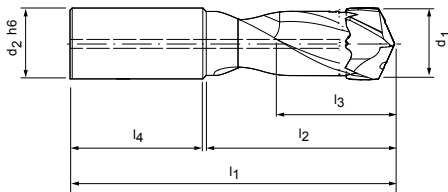

Lagerhaltige Vorzugsbaureihe

Baumaße							Schaftform HB	
d ₁	Trennstelle	d ₂ h6	l ₁	l ₂	l ₃	l ₄	Spezifikation	Bestell-Nr.
12,00-12,49	TTS12-S	14	81	29	13	45	TTS100-12-DR1-1200-14-HB	30324304
12,50-12,99	TTS12-S	14	81	29	13	45	TTS100-12-DR1-1250-14-HB	30324305
13,00-13,49	TTS12-S	14	81	31	14	45	TTS100-12-DR1-1300-14-HB	30324306
13,50-13,99	TTS12-S	16	86	32	14	48	TTS100-12-DR1-1350-16-HB	30324307
14,00-14,49	TTS12-S	16	86	33	15	48	TTS100-12-DR1-1400-16-HB	30324308
14,50-14,99	TTS12-S	16	91	34	15	48	TTS100-12-DR1-1450-16-HB	30324309
15,00-15,49	TTS12-S	16	91	36	16	48	TTS100-12-DR1-1500-16-HB	30324310
15,50-16,49	TTS12-S	18	92	38	17	48	TTS100-12-DR1-1550-18-HB	30324311
16,50-17,49	TTS12-S	18	94	40	18	48	TTS100-12-DR1-1650-18-HB	30324312
17,50-18,49	TTS12-S	18	99	43	19	48	TTS100-12-DR1-1750-18-HB	30324313
18,50-19,49	TTS12-S	20	99	45	20	50	TTS100-12-DR1-1850-20-HB	30324314
19,50-20,49	TTS12-S	20	104	47	21	50	TTS100-12-DR1-1950-20-HB	30324316
20,50-21,49	TTS12-S	25	111	49	22	56	TTS100-12-DR1-2050-25-HB	30324317
21,50-22,49	TTS12-S	25	116	52	23	56	TTS100-12-DR1-2150-25-HB	30324318
22,50-23,49	TTS12-S	25	116	54	24	56	TTS100-12-DR1-2250-25-HB	30324319
23,50-24,49	TTS12-S	25	121	56	25	56	TTS100-12-DR1-2350-25-HB	30324320
24,50-25,49	TTS18-S	25	123	59	26	56	TTS100-18-DR1-2450-25-HB	30324321
25,50-26,49	TTS18-S	25	123	61	27	56	TTS100-18-DR1-2550-25-HB	30324322
26,50-27,49	TTS18-S	25	128	63	28	56	TTS100-18-DR1-2650-25-HB	30324323
27,50-28,49	TTS18-S	25	128	66	29	56	TTS100-18-DR1-2750-25-HB	30324325
28,50-29,49	TTS18-S	32	134	68	30	60	TTS100-18-DR1-2850-32-HB	30324327
29,50-30,49	TTS18-S	32	139	70	31	60	TTS100-18-DR1-2950-32-HB	30324328
30,50-31,49	TTS18-S	32	139	75	32	60	TTS100-18-DR1-3050-32-HB	30324329
31,50-32,49	TTS18-S	32	139	75	33	60	TTS100-18-DR1-3150-32-HB	30324330
32,50-33,49	TTS18-S	32	150	78	34	60	TTS100-18-DR1-3250-32-HB	30374587
33,50-34,49	TTS18-S	32	150	79	35	60	TTS100-18-DR1-3350-32-HB	30374590
34,50-35,49	TTS12-S	32	152	86	36	60	TTS100-18-DR1-3550-32-HB	30496703
34,50-35,49	TTS18-S	32	150	82	36	60	TTS100-18-DR1-3450-32-HB	30374593
35,50-37,49	TTS18-S	40	162	86	38	70	TTS100-18-DR1-3550-40-HB	30535302
37,50-39,49	TTS18-S	32	157	91	40	60	TTS100-18-DR1-3750-32-HB	30496704
37,50-39,49	TTS18-S	40	167	71	40	70	TTS100-18-DR1-3750-40-HB	30535303

Fortsetzung auf nächster Seite.

Wechselkopfhalter TTS 100, innere Kühlmittelzufuhr

Baumaße							Schaffform HB	
d ₁	Trennstelle	d ₂ h6	l ₁	l ₂	l ₃	l ₄	Spezifikation	Bestell-Nr.
39,50-41,49	TTS18-S	32	167	95	42	60	TTS100-18-DR1-3950-32-HB	30496705
39,50-41,49	TTS18-S	40	177	95	42	70	TTS100-18-DR1-3950-40-HB	30535305
41,50-43,49	TTS18-S	40	180	100	44	70	TTS100-18-DR1-4150-40-HB	30535307
43,50-45,49	TTS18-S	40	185	105	46	70	TTS100-18-DR1-4350-40-HB	30535312

Konfigurierbare Merkmale



Schaffform:
Schaffform: HA | HE



Spezifikation:
TTS100-18-DR1-4150-40-[Schaffform]

Beispiel:

TTS100-18-DR1-4150-40-HE

Schaffform HE

Wechselkopfhalter TTS

Mit Frontspannsystem für Wechselkopfbohrer TTD
TTS100 (3xD), innere Kühlmittelzufuhr

Ausführung:

Für Bohrer Durchmesser: 12,00 - 45,49 mm
Wechselsystem: System-Frontspannung
Kopfwechsel auf der Maschine möglich

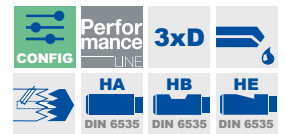
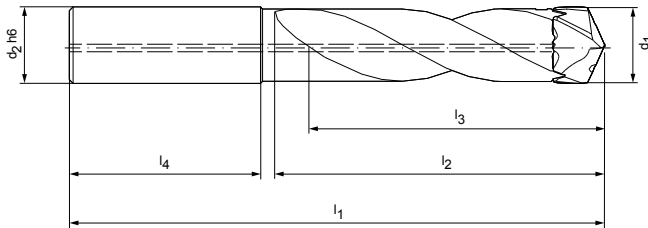

Lagerhaltige Vorzugsbaureihe

Baumaße							Schaftform HB	
d ₁	Trennstelle	d ₂ h6	l ₁	l ₂	l ₃	l ₄	Spezifikation	Bestell-Nr.
12,00-12,49	TTS12-S	14	100	53	38	45	TTS100-12-DR3-1200-14-HB	30232785
12,50-12,99	TTS12-S	14	105	55	39	45	TTS100-12-DR3-1250-14-HB	30232787
13,00-13,49	TTS12-S	14	105	57	41	45	TTS100-12-DR3-1300-14-HB	30232789
13,50-13,99	TTS12-S	16	110	59	42	48	TTS100-12-DR3-1350-16-HB	30232790
14,00-14,49	TTS12-S	16	115	61	44	48	TTS100-12-DR3-1400-16-HB	30232792
14,50-14,99	TTS12-S	16	115	63	45	48	TTS100-12-DR3-1450-16-HB	30232793
15,00-15,49	TTS12-S	16	115	65	47	48	TTS100-12-DR3-1500-16-HB	30232794
15,50-16,49	TTS12-S	18	120	70	50	48	TTS100-12-DR3-1550-18-HB	30191496
16,50-17,49	TTS12-S	18	125	74	53	48	TTS100-12-DR3-1650-18-HB	30191497
17,50-18,49	TTS12-S	18	130	78	56	48	TTS100-12-DR3-1750-18-HB	30191498
18,50-19,49	TTS12-S	20	135	82	59	50	TTS100-12-DR3-1850-20-HB	30191499
19,50-20,49	TTS12-S	20	140	87	62	50	TTS100-12-DR3-1950-20-HB	30191500
20,50-21,49	TTS12-S	25	150	91	65	56	TTS100-12-DR3-2050-25-HB	30191501
21,50-22,49	TTS12-S	25	155	95	68	56	TTS100-12-DR3-2150-25-HB	30191502
22,50-23,49	TTS12-S	25	160	99	71	56	TTS100-12-DR3-2250-25-HB	30191503
23,50-24,49	TTS12-S	25	165	103	74	56	TTS100-12-DR3-2350-25-HB	30191504
24,50-25,49	TTS18-S	25	165	108	77	56	TTS100-18-DR3-2450-25-HB	30191505
25,50-26,49	TTS18-S	25	175	112	80	56	TTS100-18-DR3-2550-25-HB	30191507
26,50-27,49	TTS18-S	25	175	116	83	56	TTS100-18-DR3-2650-25-HB	30191508
27,50-28,49	TTS18-S	25	180	120	86	56	TTS100-18-DR3-2750-25-HB	30191509
28,50-29,49	TTS18-S	32	190	124	89	60	TTS100-18-DR3-2850-32-HB	30191510
29,50-30,49	TTS18-S	32	195	129	92	60	TTS100-18-DR3-2950-32-HB	30191511
30,50-31,49	TTS18-S	32	195	133	95	60	TTS100-18-DR3-3050-32-HB	30191512
31,50-32,49	TTS18-S	32	200	137	98	60	TTS100-18-DR3-3150-32-HB	30191513
32,50-33,49	TTS18-S	32	210	144	101	60	TTS100-18-DR3-3250-32-HB	30322289
33,50-34,49	TTS18-S	32	215	148	104	60	TTS100-18-DR3-3350-32-HB	30322290
34,50-35,49	TTS18-S	32	227	161	107	60	TTS100-18-DR3-3550-32-HB	30496706
34,50-35,49	TTS18-S	32	220	153	107	60	TTS100-18-DR3-3450-32-HB	30322291
35,50-37,49	TTS18-S	40	237	161	113	70	TTS100-18-DR3-3550-40-HB	30535313
37,50-39,49	TTS18-S	32	237	170	119	60	TTS100-18-DR3-3750-32-HB	30496707
37,50-39,49	TTS18-S	40	247	170	119	70	TTS100-18-DR3-3750-40-HB	30535316
39,50-41,49	TTS18-S	32	247	178	125	60	TTS100-18-DR3-3950-32-HB	30496708

Fortsetzung auf nächster Seite.

Wechselkopfhalter TTS 100 (3xD), innere Kühlmittelzufuhr

Baumaße							Schaftform HB	
d ₁	Trennstelle	d ₂ h6	l ₁	l ₂	l ₃	l ₄	Spezifikation	Bestell-Nr.
39,50-41,49	TTS18-S	40	257	178	125	70	TTS100-18-DR3-3950-40-HB	30535318
41,50-43,49	TTS18-S	40	265	187	131	70	TTS100-18-DR3-4150-40-HB	30535320
43,50-45,49	TTS18-S	40	275	196	137	70	TTS100-18-DR3-4350-40-HB	30535321

Konfigurierbare Merkmale



Schaftform:
Schaftform: HA | HE



Spezifikation:
TTS100-18-DR5-4150-40-[Schaftform]

Beispiel:

TTS100-18-DR5-4150-40-HE

Schaftform HE

Wechselkopfhalter TTS

Mit Frontspannsystem für Wechselkopfbohrer TTD
TTS100 (5xD), innere Kühlmittelzufuhr

Ausführung:

Für Bohrer Durchmesser: 12,00 - 45,49 mm
Wechselsystem: System-Frontspannung
Kopfwechsel auf der Maschine möglich

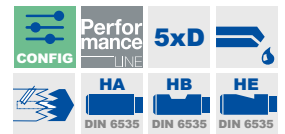
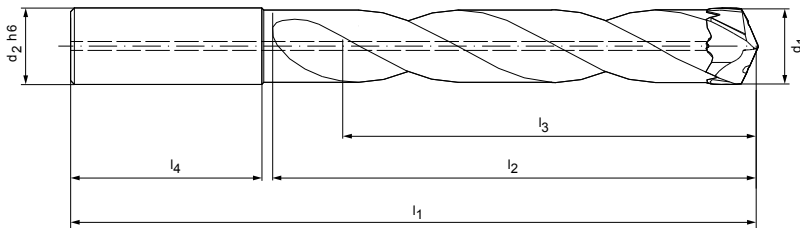

Lagerhaltige Vorzugsbaureihe

Baumaße							Schaftform HB	
d ₁	Trennstelle	d ₂ h6	l ₁	l ₂	l ₃	l ₄	Spezifikation	Bestell-Nr.
12,00-12,49	TTS12-S	14	125	78	63	45	TTS100-12-DR5-1200-14-HB	30232796
12,50-12,99	TTS12-S	14	130	81	65	45	TTS100-12-DR5-1250-14-HB	30232798
13,00-13,49	TTS12-S	14	130	84	68	45	TTS100-12-DR5-1300-14-HB	30232799
13,50-13,99	TTS12-S	16	140	88	70	48	TTS100-12-DR5-1350-16-HB	30232800
14,00-14,49	TTS12-S	16	140	90	73	48	TTS100-12-DR5-1400-16-HB	30232801
14,50-14,99	TTS12-S	16	145	94	75	48	TTS100-12-DR5-1450-16-HB	30232802
15,00-15,49	TTS12-S	16	145	96	78	48	TTS100-12-DR5-1500-16-HB	30232803
15,50-16,49	TTS12-S	18	155	103	83	48	TTS100-12-DR5-1550-18-HB	30191514
16,50-17,49	TTS12-S	18	160	109	88	48	TTS100-12-DR5-1650-18-HB	30191515
17,50-18,49	TTS12-S	18	165	115	93	48	TTS100-12-DR5-1750-18-HB	30191516
18,50-19,49	TTS12-S	20	175	121	98	50	TTS100-12-DR5-1850-20-HB	30191517
19,50-20,49	TTS12-S	20	180	128	103	50	TTS100-12-DR5-1950-20-HB	30191518
20,50-21,49	TTS12-S	25	195	134	108	56	TTS100-12-DR5-2050-25-HB	30191519
21,50-22,49	TTS12-S	25	200	140	113	56	TTS100-12-DR5-2150-25-HB	30191520
22,50-23,49	TTS12-S	25	205	146	118	56	TTS100-12-DR5-2250-25-HB	30191521
23,50-24,49	TTS12-S	25	210	152	123	56	TTS100-12-DR5-2350-25-HB	30191522
24,50-25,49	TTS18-S	25	220	159	128	56	TTS100-18-DR5-2450-25-HB	30191523
25,50-26,49	TTS18-S	25	225	165	133	56	TTS100-18-DR5-2550-25-HB	30191525
26,50-27,49	TTS18-S	25	230	171	138	56	TTS100-18-DR5-2650-25-HB	30191526
27,50-28,49	TTS18-S	25	240	177	143	56	TTS100-18-DR5-2750-25-HB	30191527
28,50-29,49	TTS18-S	32	250	183	148	60	TTS100-18-DR5-2850-32-HB	30191528
29,50-30,49	TTS18-S	32	255	190	153	60	TTS100-18-DR5-2950-32-HB	30191529
30,50-31,49	TTS18-S	32	260	196	158	60	TTS100-18-DR5-3050-32-HB	30191530
31,50-32,49	TTS18-S	32	265	202	163	60	TTS100-18-DR5-3150-32-HB	30191531
32,50-33,49	TTS18-S	32	275	210	168	60	TTS100-18-DR5-3250-32-HB	30322313
33,50-34,49	TTS18-S	32	285	217	173	60	TTS100-18-DR5-3350-32-HB	30322314
34,50-35,49	TTS18-S	32	290	224	178	60	TTS100-18-DR5-3450-32-HB	30322315
35,50-37,49	TTS18-S	32	302	236	188	60	TTS100-18-DR5-3550-32-HB	30496709
*35,50-37,49	TTS18-S	40	312	236	188	70	TTS100-18-DR5-3550-40-HB	30535324
37,50-39,49	TTS18-S	32	317	249	198	60	TTS100-18-DR5-3750-32-HB	30496710
*37,50-39,49	TTS18-S	40	327	249	198	70	TTS100-18-DR5-3750-40-HB	30534860

Fortsetzung auf nächster Seite.

Wechselkopfhalter TTS 100 (5xD), innere Kühlmittelzufuhr

Baumaße							Schافتform HB	
d ₁	Trennstelle	d ₂ h6	l ₁	l ₂	l ₃	l ₄	Spezifikation	Bestell-Nr.
39,50-41,49	TTS18-S	32	327	261	208	60	TTS100-18-DR5-3950-32-HB	30496711
*39,50-41,49	TTS18-S	40	337	261	208	70	TTS100-18-DR5-3950-40-HB	30535326
*41,50-43,49	TTS18-S	40	350	274	218	70	TTS100-18-DR5-4150-40-HB	30535327
*43,50-45,49	TTS18-S	40	365	287	228	70	TTS100-18-DR5-4350-40-HB	30535328

Konfigurierbare Merkmale



Schaftform:
Schaftform: HA | HE



Spezifikation:
TTS100-18-DR5-4150-40-[Schaftform]

Beispiel:

TTS100-18-DR5-4150-40-HE

Schaftform HE

Wechselkopfhalter TTS

Mit Frontspannsystem für Wechselkopfbohrer TTD
TTS100 (8xD), innere Kühlmittelzufuhr

Ausführung:

Für Bohrer Durchmesser: 12,00 - 45,49 mm
Wechselsystem: System-Frontspannung
Kopfwechsel auf der Maschine möglich

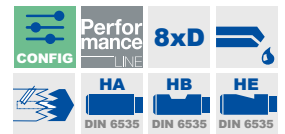
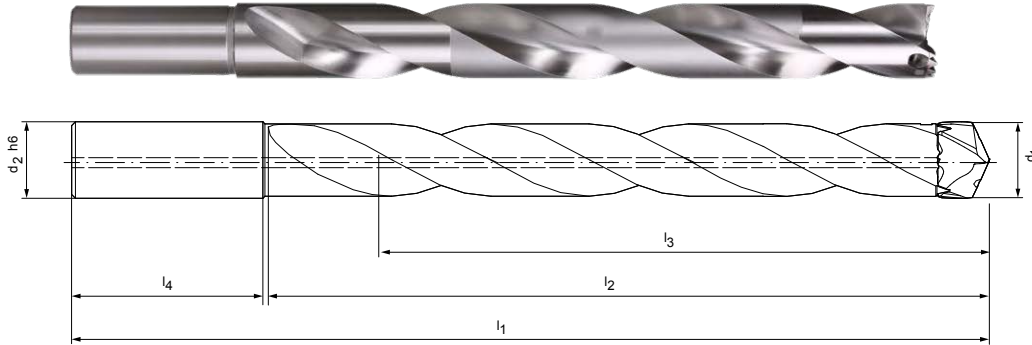

Lagerhaltige Vorzugsbaureihe

Baumaße							Schaftform HB	
d_1	Trennstelle	$d_2 h6$	l_1	l_2	l_3	l_4	Spezifikation	Bestell-Nr.
12,00-12,49	TTS12-S	14	165	116	100	45	TTS100-12-DR8-1200-14-HB	30232805
12,50-12,99	TTS12-S	14	170	121	104	45	TTS100-12-DR8-1250-14-HB	30232806
13,00-13,49	TTS12-S	14	175	126	108	45	TTS100-12-DR8-1300-14-HB	30232807
13,50-13,99	TTS12-S	16	180	129	112	48	TTS100-12-DR8-1350-16-HB	30232808
14,00-14,49	TTS12-S	16	185	134	116	48	TTS100-12-DR8-1400-16-HB	30232809
14,50-14,99	TTS12-S	16	190	139	120	48	TTS100-12-DR8-1450-16-HB	30232810
15,00-15,49	TTS12-S	16	195	144	124	48	TTS100-12-DR8-1500-16-HB	30232811
15,50-16,49	TTS12-S	18	205	152	132	48	TTS100-12-DR8-1550-18-HB	30191532
16,50-17,49	TTS12-S	18	215	161	140	48	TTS100-12-DR8-1650-18-HB	30191533
17,50-18,49	TTS12-S	18	220	171	148	48	TTS100-12-DR8-1750-18-HB	30191534
18,50-19,49	TTS12-S	20	235	180	156	50	TTS100-12-DR8-1850-20-HB	30191535
19,50-20,49	TTS12-S	20	240	189	164	50	TTS100-12-DR8-1950-20-HB	30191536
20,50-21,49	TTS12-S	25	260	198	172	56	TTS100-12-DR8-2050-25-HB	30191537
21,50-22,49	TTS12-S	25	270	207	180	56	TTS100-12-DR8-2150-25-HB	30191538
22,50-23,49	TTS12-S	25	275	217	188	56	TTS100-12-DR8-2250-25-HB	30191539
23,50-24,49	TTS12-S	25	285	226	196	56	TTS100-12-DR8-2350-25-HB	30191540
24,50-25,49	TTS18-S	25	295	235	204	56	TTS100-18-DR8-2450-25-HB	30191541
25,50-26,49	TTS18-S	25	305	244	212	56	TTS100-18-DR8-2550-25-HB	30191543
26,50-27,49	TTS18-S	25	315	253	220	56	TTS100-18-DR8-2650-25-HB	30191544
27,50-28,49	TTS18-S	25	325	263	228	56	TTS100-18-DR8-2750-25-HB	30191545
28,50-29,49	TTS18-S	32	340	272	236	60	TTS100-18-DR8-2850-32-HB	30191546
29,50-30,49	TTS18-S	32	345	281	244	60	TTS100-18-DR8-2950-32-HB	30191547
30,50-31,49	TTS18-S	32	355	290	252	60	TTS100-18-DR8-3050-32-HB	30191548
31,50-32,49	TTS18-S	32	360	299	260	60	TTS100-18-DR8-3150-32-HB	30191549
32,50 - 33,49	TTS18-S	32	375	275	268	60	TTS100-18-DR8-3250-32-HB	30809129
33,50 - 34,49	TTS18-S	32	385	317	276	60	TTS100-18-DR8-3350-32-HB	30809654
34,50 - 35,49	TTS18-S	32	395	329	284	60	TTS100-18-DR8-3450-32-HB	30809664
35,50 - 37,49	TTS18-S	32	402	336	300	60	TTS100-18-DR8-3550-32-HB	30812380
35,50 - 37,49	TTS18-S	40	412	336	300	70	TTS100-18-DR8-3550-40-HB	30809673

Fortsetzung auf nächster Seite.

Wechselkopfhalter TTS 100 (8xD), innere Kühlmittelzufuhr

Baumaße							Schaftform HB	
d ₁	Trennstelle	d ₂ h6	l ₁	l ₂	l ₃	l ₄	Spezifikation	Bestell-Nr.
37,50 - 39,49	TTS18-S	32	421	353	316	60	TTS100-18-DR8-3750-32-HB	30812379
37,50 - 39,49	TTS18-S	40	431	353	316	70	TTS100-18-DR8-3750-40-HB	30809961
39,50 - 41,49	TTS18-S	32	440	374	332	70	TTS100-18-DR8-3950-32-HB	30812376
39,50 - 41,49	TTS18-S	40	450	374	332	70	TTS100-18-DR8-3950-40-HB	30809964
41,50 - 43,49	TTS18-S	40	470	394	348	70	TTS100-18-DR8-4150-40-HB	30809976
43,50 - 45,49	TTS18-S	40	500	422	364	70	TTS100-18-DR8-4350-40-HB	30809158

Konfigurierbare Merkmale



Schaftform:
Schaftform: HA | HE

**Spezifikation:**

TTS100-18-DR8-4150-40-[Schaftform]

Beispiel:

TTS100-18-DR8-4150-40-HE

Schaftform HE

Wechselkopfhalter TTS

Mit Frontspannsystem für Wechselkopfbohrer TTD
TTS100 (12xD), innere Kühlmittelzufuhr

Ausführung:

Für Bohrerdurchmesser: 12,00 - 32,49 mm
Wechselsystem: System-Frontspannung
Kopfwechsel auf der Maschine möglich

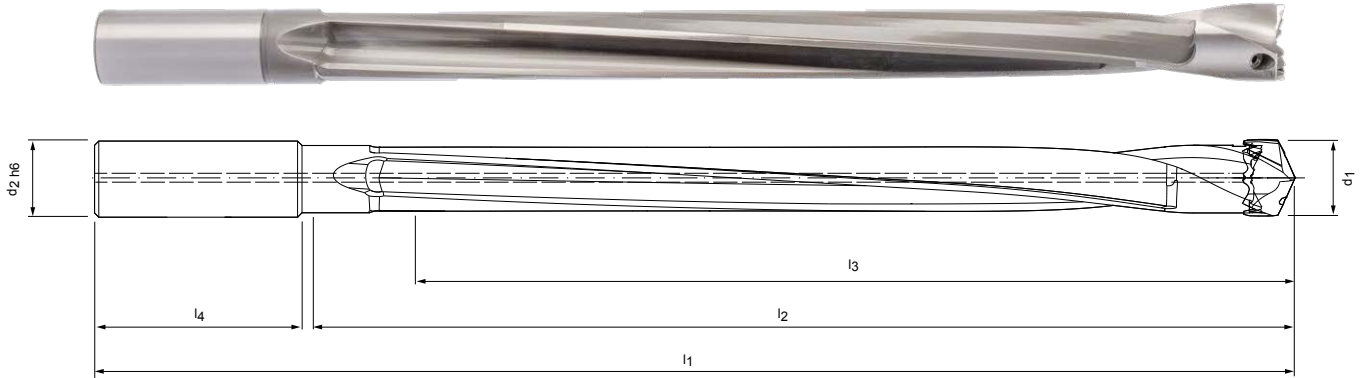

Lagerhaltige Vorzugsbaureihe

		Baumaße					Schaftform HB	
d ₁	Trennstelle	d ₂ h6	l ₁	l ₂	l ₃	l ₄	Spezifikation	Bestell-Nr.
12,00-12,49	TTS12-S	14	210	162	150	45	TTS100-12-DR12-1200-14-HB	30327798
12,50-12,99	TTS12-S	14	216	168	156	45	TTS100-12-DR12-1250-14-HB	30327802
13,00-13,49	TTS12-S	14	223	175	162	45	TTS100-12-DR12-1300-14-HB	30327805
13,50-13,99	TTS12-S	16	235	182	168	48	TTS100-12-DR12-1350-16-HB	30327808
14,00-14,49	TTS12-S	16	242	189	174	48	TTS100-12-DR12-1400-16-HB	30327811
14,50-14,99	TTS12-S	16	248	195	180	48	TTS100-12-DR12-1450-16-HB	30327814
15,00-15,49	TTS12-S	16	255	202	186	48	TTS100-12-DR12-1500-16-HB	30327817
15,50-16,49	TTS12-S	18	262	209	198	48	TTS100-12-DR12-1550-18-HB	30327820
16,50-17,49	TTS12-S	18	275	222	210	48	TTS100-12-DR12-1650-18-HB	30327824
17,50-18,49	TTS12-S	18	289	236	222	48	TTS100-12-DR12-1750-18-HB	30327828
18,50-19,49	TTS12-S	20	304	249	234	50	TTS100-12-DR12-1850-20-HB	30327833
19,50-20,49	TTS12-S	20	318	263	246	50	TTS100-12-DR12-1950-20-HB	30255588
20,50-21,49	TTS12-S	25	337	276	258	56	TTS100-12-DR12-2050-25-HB	30327844
21,50-22,49	TTS12-S	25	351	290	270	56	TTS100-12-DR12-2150-25-HB	30327847
22,50-23,49	TTS12-S	25	364	303	282	56	TTS100-12-DR12-2250-25-HB	30327851
23,50-24,49	TTS12-S	25	378	317	294	56	TTS100-12-DR12-2350-25-HB	30327854
24,50-25,49	TTS18-S	25	391	330	306	56	TTS100-18-DR12-2450-25-HB	30327859
25,50-26,49	TTS18-S	25	405	344	318	56	TTS100-18-DR12-2550-25-HB	30327863
26,50-27,49	TTS18-S	25	418	357	330	56	TTS100-18-DR12-2650-25-HB	30327866
27,50-28,49	TTS18-S	25	432	371	342	56	TTS100-18-DR12-2750-25-HB	30327870
28,50-29,49	TTS18-S	32	449	384	354	60	TTS100-18-DR12-2850-32-HB	30327873
29,50-30,49	TTS18-S	32	463	398	366	60	TTS100-18-DR12-2950-32-HB	30327876
30,50-31,49	TTS18-S	32	476	411	378	60	TTS100-18-DR12-3050-32-HB	30327879
31,50-32,49	TTS18-S	32	490	425	390	60	TTS100-18-DR12-3150-32-HB	30327883

Konfigurierbare Merkmale



Schaftform:
Schaftform: HA | HE



Spezifikation:

TTS100-18-DR12-2850-32-[Schaftform]

Beispiel:

TTS100-18-DR12-2850-32-HE

Schaftform HE

Maßangaben in mm.

Beachten Sie die Handhabungshinweise für den Wechselkopfbohrer TTD (12xD) auf Seite 748. Sonderausführungen auf Anfrage.

Ersatzteile

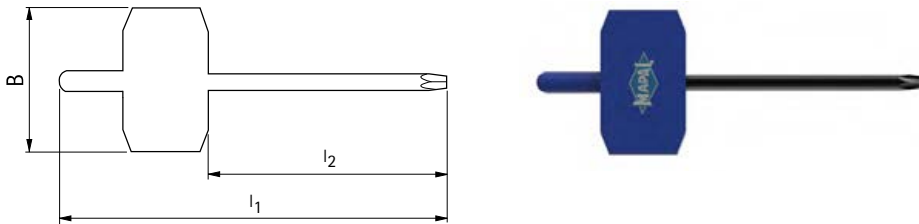

Sechskant-Schraubendreher

Haltertyp	sw	l_1	l_2	B	Bestell-Nr.
TS100-12-DRx-1200-14-HB	1,3	95	60	38	10004355
TS100-12-DRx-1250-14-HB	1,3	95	60	38	10004355
TS100-12-DRx-1300-14-HB	1,3	95	60	38	10004355
TS100-12-DRx-1350-16-HB	1,5	95	60	38	10098108
TS100-12-DRx-1400-16-HB	1,5	95	60	38	10098108
TS100-12-DRx-1450-16-HB	1,5	95	60	38	10098108
TS100-12-DRx-1500-16-HB	1,5	95	60	38	10098108
TS100-12-DRx-1550-18-HB	1,5	95	60	38	10098108
TS100-12-DRx-1650-18-HB	2	95	60	38	10098109
TS100-12-DRx-1750-18-HB	2	95	60	38	10098109
TS100-12-DRx-1850-20-HB	2	95	60	38	10098109
TS100-12-DRx-1950-20-HB	2	95	60	38	10098109
TS100-12-DRx-2050-25-HB	2	95	60	38	10098109
TS100-12-DRx-2150-25-HB	2	95	60	38	10098109
TS100-12-DRx-2250-25-HB	2	95	60	38	10098109
TS100-12-DRx-2350-25-HB	2	95	60	38	10098109
TS100-18-DRx-2450-25-HB	2,5	95	60	38	10098110
TS100-18-DRx-2550-25-HB	2,5	95	60	38	10098110
TS100-18-DRx-2650-25-HB	2,5	95	60	38	10098110
TS100-18-DRx-2750-25-HB	2,5	95	60	38	10098110
TS100-18-DRx-2850-32-HB	2,5	95	60	38	10098110
TS100-18-DRx-2950-32-HB	2,5	95	60	38	10098110
TS100-18-DRx-3050-32-HB	2,5	95	60	38	10098110
TS100-18-DRx-3150-32-HB	2,5	95	60	38	10098110
TS100-18-DRx-3250-32-HB	3	100	60	38	10006234
TS100-18-DRx-3350-32-HB	3	100	60	38	10006234
TS100-18-DRx-3450-32-HB	3	100	60	38	10006234
TS100-18-DRx-3550-40-HB	3	100	60	38	10006234
TS100-18-DRx-3750-40-HB	3	100	60	38	10006234
TS100-18-DRx-3950-40-HB	3	100	60	38	10006234
TS100-18-DRx-4150-40-HB	4	100	60	38	10006235
TS100-18-DRx-4350-40-HB	4	100	60	38	10006235

Gewindestift mit Spezialbeschichtung

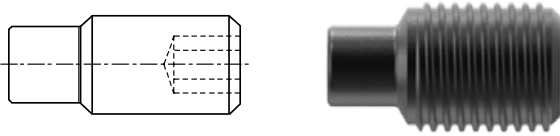

Haltertyp	Gewindestift	Anzugsdrehmoment [Nm]	Bestell-Nr.
TS100-12-DRx-1200-14-HB	M2,5x5	1,0	30259117
TS100-12-DRx-1250-14-HB	M2,5x6	1,0	30259118
TS100-12-DRx-1300-14-HB	M2,5x6	1,0	30259118
TS100-12-DRx-1350-16-HB	M3x6	1,3	30259119
TS100-12-DRx-1400-16-HB	M3x6	1,3	30259119
TS100-12-DRx-1450-16-HB	M3x7	1,3	30193231
TS100-12-DRx-1500-16-HB	M3x7	1,3	30193231
TS100-12-DRx-1550-18-HB	M3x7	1,3	30193231
TS100-12-DRx-1650-18-HB	M4x0,5x7,5	3,5	30193232
TS100-12-DRx-1750-18-HB	M4x0,5x7,5	3,5	30193232
TS100-12-DRx-1850-20-HB	M4x0,5x7,5	3,5	30193232
TS100-12-DRx-1950-20-HB	M4x0,5x7,5	3,5	30193232
TS100-12-DRx-2050-25-HB	M4x0,5x10	3,5	30193233
TS100-12-DRx-2150-25-HB	M4x0,5x10	3,5	30193233
TS100-12-DRx-2250-25-HB	M4x0,5x10	3,5	30193233
TS100-12-DRx-2350-25-HB	M4x0,5x10	3,5	30193233
TS100-18-DRx-2450-25-HB	M5x0,5x11	4,0	30193234
TS100-18-DRx-2550-25-HB	M5x0,5x11	4,0	30193234
TS100-18-DRx-2650-25-HB	M5x0,5x11	4,0	30193234
TS100-18-DRx-2750-25-HB	M5x0,5x11	4,0	30193234
TS100-18-DRx-2850-32-HB	M5x0,5x14	4,0	30193235
TS100-18-DRx-2950-32-HB	M5x0,5x14	4,0	30193235
TS100-18-DRx-3050-32-HB	M5x0,5x14	4,0	30193235
TS100-18-DRx-3150-32-HB	M5x0,5x14	4,0	30193235
TS100-18-DRx-3250-32-HB	M6x0,5x16	6,0	30320812
TS100-18-DRx-3350-32-HB	M6x0,5x16	6,0	30320812
TS100-18-DRx-3450-32-HB	M6x0,5x16	6,0	30320812
TS100-18-DRx-3550-40-HB	M6x0,5x18	6,0	30320811
TS100-18-DRx-3750-40-HB	M6x0,5x18	6,0	30320811
TS100-18-DRx-3950-40-HB	M6x0,5x20	6,0	30320810
TS100-18-DRx-4150-40-HB	M8x1x20	10,0	30320806
TS100-18-DRx-4350-40-HB	M8x1x20	10,0	30320806

Schnittwertempfehlung für Wechselkopfbohrer TTD

Vorschub und Schnittgeschwindigkeit

Typ 01 – Uni-Plus

MZG*	Werkstoff	Festigkeit/Härte [N/mm ²] [HRC]
P	P1.1 Bau-, Automaten-, Einsatz- und Vergütungsstähle, unlegiert	< 700
	P1.2 Bau-, Automaten-, Einsatz- und Vergütungsstähle, unlegiert	< 1.200
	P2.1 Nitrier-, Einsatz- und Vergütungsstähle, legiert	< 900
	P2.2 Nitrier-, Einsatz- und Vergütungsstähle, legiert	< 1.400
	P3.1 Werkzeug-, Wälzlager-, Feder- und Schnellarbeitsstähle**	< 800
	P3.2 Werkzeug-, Wälzlager-, Feder- und Schnellarbeitsstähle**	< 1.000
	P3.3 Werkzeug-, Wälzlager-, Feder- und Schnellarbeitsstähle**	< 1.500
P5	P5.1 Stahlguss	
K	K1.1 Gusseisen mit Lamellengraphit (Grauguss), GJL	< 300
	K2.1 Gusseisen mit Kugelgraphit, GJS	< 500
	K2.2 Gusseisen mit Kugelgraphit, GJS	≤ 800
	K2.3 Gusseisen mit Kugelgraphit, GJS	> 800
	K3.1 Gusseisen mit Vermiculargraphit, GJV; Temperguss, GJM	< 500
	K3.2 Gusseisen mit Vermiculargraphit, GJV; Temperguss, GJM	> 500

Typ 04 – Steel

MZG*	Werkstoff	Festigkeit/Härte [N/mm ²] [HRC]
P	P1.1 Bau-, Automaten-, Einsatz- und Vergütungsstähle, unlegiert	< 700
	P1.2 Bau-, Automaten-, Einsatz- und Vergütungsstähle, unlegiert	< 1.200
	P2.1 Nitrier-, Einsatz- und Vergütungsstähle, legiert	< 900
	P2.2 Nitrier-, Einsatz- und Vergütungsstähle, legiert	< 1.400
	P3.1 Werkzeug-, Wälzlager-, Feder- und Schnellarbeitsstähle**	< 800
	P3.2 Werkzeug-, Wälzlager-, Feder- und Schnellarbeitsstähle**	< 1.000
	P3.3 Werkzeug-, Wälzlager-, Feder- und Schnellarbeitsstähle**	< 1.500
P4	P4.1 Rostfreie Stähle, ferritisch und martensitisch	
P5	P5.1 Stahlguss	
P6	P6.1 Rostfreier Stahlguss, ferritisch und martensitisch	
K	K1.1 Gusseisen mit Lamellengraphit (Grauguss), GJL	< 300
	K2.1 Gusseisen mit Kugelgraphit, GJS	< 500
	K2.2 Gusseisen mit Kugelgraphit, GJS	≤ 800
	K2.3 Gusseisen mit Kugelgraphit, GJS	> 800
	K3.1 Gusseisen mit Vermiculargraphit, GJV; Temperguss, GJM	< 500
	K3.2 Gusseisen mit Vermiculargraphit, GJV; Temperguss, GJM	> 500

Typ 03 – Alu

MZG*	Werkstoff	Festigkeit/Härte [N/mm ²] [HRC]
N1	N1.1 Aluminium, unlegiert und legiert < 3 % Si	
	N1.2 Aluminium, legiert ≤ 7 % Si	
	N1.3 Aluminium, legiert > 7-12 % Si	
	N1.4 Aluminium, legiert > 12 % Si	
N2	N2.1 Kupfer, unlegiert und niedriglegiert	< 300
	N2.2 Kupfer, legiert	> 300
	N2.3 Messing, Bronze, Rotguss	< 1.200

* MAPAL Zerspanungsgruppen

** Wenn die Legierungsbestandteile Cr, Mo, Ni, V, W in Summe > 8 %, dann die nächst höhere MAPAL Zerspanungsgruppe wählen.

	Schnittgeschwindigkeit v_c [m/min]				Vorschub f [mm] bei Bohrerdurchmesser					
	Innenkühlung	Außenkühlung	MMS	Luft	12,00	15,50	19,50	25,00	32,00	40,00
	110	100	100		0,23	0,26	0,29	0,32	0,33	0,33
	100	85	85		0,29	0,33	0,37	0,40	0,41	0,41
	110	95	95		0,27	0,31	0,35	0,37	0,39	0,39
	75	65	65		0,22	0,25	0,27	0,30	0,31	0,31
	85	70	70		0,24	0,28	0,31	0,34	0,35	0,35
	65	60	60		0,20	0,23	0,25	0,27	0,28	0,29
	65	50	55		0,16	0,18	0,20	0,21	0,22	0,22
	110	95	95		0,27	0,31	0,35	0,37	0,39	0,39
	110	75	75	75	0,34	0,39	0,44	0,48	0,49	0,49
	145	90	110	110	0,31	0,36	0,40	0,44	0,45	0,46
	90	70	70		0,27	0,31	0,35	0,38	0,39	0,39
	55	35	45		0,18	0,21	0,23	0,25	0,26	0,26
	80	70	70		0,29	0,34	0,37	0,40	0,42	0,42
	70	65	65		0,23	0,27	0,30	0,32	0,33	0,33

	Schnittgeschwindigkeit v_c [m/min]				Vorschub f [mm] bei Bohrerdurchmesser					
	Innenkühlung	Außenkühlung	MMS	Luft	12,00	15,50	19,50	25,00	32,00	40,00
	110	100	100		0,26	0,30	0,34	0,36	0,38	0,38
	100	85	85		0,33	0,38	0,42	0,46	0,47	0,47
	110	95	95		0,31	0,36	0,40	0,43	0,45	0,45
	75	65	65		0,25	0,28	0,31	0,34	0,35	0,35
	85	70	70		0,28	0,32	0,36	0,39	0,40	0,41
	65	60	60		0,23	0,26	0,29	0,32	0,33	0,33
	65	50	55		0,18	0,20	0,23	0,24	0,25	0,25
	65	50	55		0,18	0,21	0,24	0,25	0,26	0,27
	110	95	95		0,31	0,36	0,40	0,43	0,45	0,45
	110	75	75	75	0,37	0,44	0,49	0,53	0,55	0,55
	145	90	110	110	0,35	0,40	0,45	0,49	0,50	0,51
	90	70	70		0,30	0,35	0,39	0,42	0,43	0,43
	55	35	45		0,20	0,23	0,25	0,27	0,28	0,29
	80	70	70		0,32	0,37	0,41	0,45	0,47	0,47
	70	65	65		0,26	0,30	0,33	0,35	0,37	0,37

	Schnittgeschwindigkeit v_c [m/min]				Vorschub f [mm] bei Bohrerdurchmesser					
	Innenkühlung	Außenkühlung	MMS	Luft	12,00	15,50	19,50	25,00	32,00	40,00
	300	200	250		0,23	0,26	0,29	0,32	0,33	0,33
	250	180	200		0,30	0,35	0,39	0,42	0,43	0,43
	220	150	180		0,30	0,35	0,39	0,42	0,43	0,43
	180	120	150		0,30	0,35	0,39	0,42	0,43	0,43
	140	100			0,23	0,26	0,29	0,32	0,33	0,33
	120	90			0,30	0,35	0,39	0,42	0,43	0,43
	200	160	160	120	0,37	0,44	0,49	0,53	0,55	0,55

Die angegebenen Schnittwerte sind Richtwerte.

Die für den jeweiligen Bearbeitungsfall optimalen Daten sollten im Versuch oder während der Bearbeitung ermittelt werden.

Schnittwertempfehlung für Wechselkopfbohrer TTD

Vorschub und Schnittgeschwindigkeit

Typ O2 – Inox

MZG*	Werkstoff	Festigkeit/Härte [N/mm ²] [HRC]
P	P1.1 Bau-, Automaten-, Einsatz- und Vergütungsstähle, unlegiert	< 700
	P1.2 Bau-, Automaten-, Einsatz- und Vergütungsstähle, unlegiert	< 1.200
	P2.1 Nitrier-, Einsatz- und Vergütungsstähle, legiert	< 900
	P2.2 Nitrier-, Einsatz- und Vergütungsstähle, legiert	< 1.400
	P3.1 Werkzeug-, Wälzlager-, Feder- und Schnellarbeitsstähle**	< 800
	P3.2 Werkzeug-, Wälzlager-, Feder- und Schnellarbeitsstähle**	< 1.000
	P3.3 Werkzeug-, Wälzlager-, Feder- und Schnellarbeitsstähle**	< 1.500
	P4.1 Rostfreie Stähle, ferritisch und martensitisch	
	P5.1 Stahlguss	
	P6.1 Rostfreier Stahlguss, ferritisch und martensitisch	
M	M1.1 Rostfreie Stähle, austenitisch	< 700
	M1.2 Rostfreie Stähle, ferritisch/austenitisch (Duplex)	< 1.000
	M2.1 Rostfreier Stahlguss, austenitisch	< 700
	M3.1 Rostfreier Stahlguss, ferritisch/austenitisch (Duplex)	< 1.000
K	K1.1 Gusseisen mit Lamellengraphit (Grauguss), GJL	< 300
	K2.1 Gusseisen mit Kugelgraphit, GJS	< 500
	K2.2 Gusseisen mit Kugelgraphit, GJS	≤ 800
	K2.3 Gusseisen mit Kugelgraphit, GJS	> 800
	K3.1 Gusseisen mit Vermiculargraphit, GJV; Temperguss, GJM	< 500
	K3.2 Gusseisen mit Vermiculargraphit, GJV; Temperguss, GJM	> 500
N2	N2.1 Kupfer, unlegiert und niedriglegiert	< 300
	N2.2 Kupfer, legiert	> 300
	N2.3 Messing, Bronze, Rotguss	< 1.200
S	S1.1 Titan, Titanlegierungen	< 400
	S2.1 Titan, Titanlegierungen	< 1.200
	S2.2 Titan, Titanlegierungen	> 1.200
	S3.1 Nickel, unlegiert und legiert	< 900
	S3.2 Nickel, unlegiert und legiert	> 900
	S4.1 Hochwarmfeste Superlegierung, Ni-, Co-, und Fe-basiert	
	S5.1 Wolfram- und Molybdänlegierungen	

Typ O5 – Iron

MZG*	Werkstoff	Festigkeit/Härte [N/mm ²] [HRC]
K	K1.1 Gusseisen mit Lamellengraphit (Grauguss), GJL	< 300
	K2.1 Gusseisen mit Kugelgraphit, GJS	< 500
	K2.2 Gusseisen mit Kugelgraphit, GJS	≤ 800
	K2.3 Gusseisen mit Kugelgraphit, GJS	> 800
	K3.1 Gusseisen mit Vermiculargraphit, GJV; Temperguss, GJM	< 500
	K3.2 Gusseisen mit Vermiculargraphit, GJV; Temperguss, GJM	> 500

* MAPAL Zerspanungsgruppen

** Wenn die Legierungsbestandteile Cr, Mo, Ni, V, W in Summe > 8 %, dann die nächst höhere MAPAL Zerspanungsgruppe wählen.

	Schnittgeschwindigkeit v_c [m/min]				Vorschub f [mm] bei Bohrerdurchmesser					
	Innenkühlung	Außenkühlung	MMS	Luft	12,00	15,50	19,50	25,00	32,00	40,00
	100	90	90		0,21	0,24	0,26	0,28	0,30	0,30
	90	75	75		0,26	0,30	0,33	0,36	0,37	0,37
	100	85	85		0,24	0,28	0,31	0,34	0,35	0,35
	70	60	60		0,19	0,22	0,25	0,27	0,28	0,28
	75	65	65		0,22	0,25	0,28	0,30	0,32	0,32
	60	55	55		0,18	0,21	0,23	0,25	0,26	0,26
	60	45	50		0,14	0,16	0,18	0,19	0,20	0,20
	60	45	50		0,14	0,17	0,18	0,20	0,21	0,21
	100	85	85		0,24	0,28	0,31	0,34	0,35	0,35
	60	45	50		0,14	0,17	0,18	0,20	0,21	0,21
	55	35	35		0,18	0,21	0,24	0,25	0,26	0,27
	50	30	30		0,16	0,18	0,20	0,22	0,23	0,23
	55	35	35		0,18	0,21	0,24	0,25	0,26	0,27
	50	30	30		0,16	0,18	0,20	0,22	0,23	0,23
	95	70	70	70	0,34	0,39	0,44	0,48	0,49	0,49
	130	80	95	95	0,31	0,36	0,40	0,44	0,45	0,46
	80	60	60		0,27	0,31	0,35	0,38	0,39	0,39
	50	30	40		0,18	0,21	0,23	0,25	0,26	0,26
	70	65	65		0,29	0,34	0,37	0,40	0,42	0,42
	65	55	55		0,23	0,27	0,30	0,32	0,33	0,33
	140	100			0,23	0,26	0,29	0,32	0,33	0,33
	120	90			0,30	0,35	0,39	0,42	0,43	0,43
	200	160	160	120	0,37	0,44	0,49	0,53	0,55	0,55
	40	25			0,16	0,18	0,21	0,22	0,23	0,23
	30	20			0,14	0,16	0,18	0,19	0,20	0,20
	25	15			0,11	0,13	0,15	0,16	0,16	0,17
	20	15			0,09	0,11	0,12	0,13	0,13	0,13
	15	10			0,11	0,13	0,15	0,16	0,16	0,17
	15	10			0,09	0,11	0,12	0,13	0,13	0,13
	15	10			0,09	0,11	0,12	0,13	0,13	0,13

	Schnittgeschwindigkeit v_c [m/min]				Vorschub f [mm] bei Bohrerdurchmesser					
	Innenkühlung	Außenkühlung	MMS	Luft	12,00	15,50	19,50	25,00	32,00	40,00
	120	85	85	85	0,45	0,52	0,58	0,63	0,66	0,66
	160	100	120	120	0,42	0,48	0,54	0,58	0,60	0,61
	100	75	75		0,36	0,42	0,46	0,50	0,52	0,52
	60	40	50		0,24	0,28	0,30	0,33	0,34	0,34
	90	80	80		0,39	0,45	0,50	0,54	0,56	0,56
	80	70	70		0,31	0,36	0,39	0,43	0,44	0,44

Die angegebenen Schnittwerte sind Richtwerte.

Die für den jeweiligen Bearbeitungsfall optimalen Daten sollten im Versuch oder während der Bearbeitung ermittelt werden.

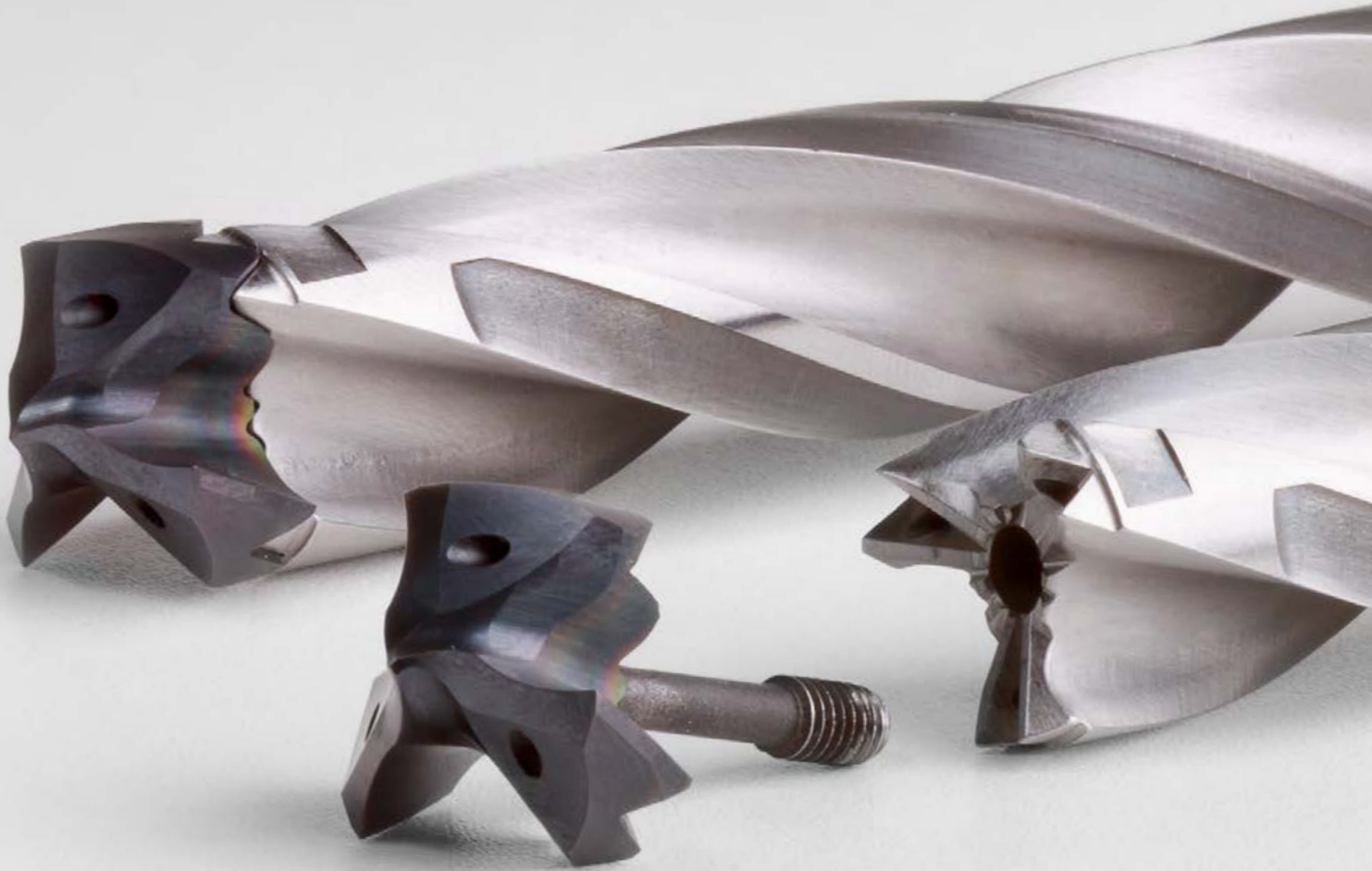

WECHSELKOPFBOHRER TTD-TRITAN

Minimierter Einsatz von Hartmetall bei höchster Stabilität und Präzision

Auch der dreischneidige Tritan-Drill steht als Wechselkopf-Variante zur Verfügung.

Werkzeugkopf und Werkzeughalter sind über eine Hirth-Verzahnung verbunden. Diese Schnittstelle ist besonders stabil, so dass mit der Wechselkopfvariante alle Vorteile sowie das Leistungsniveau des Pendants aus Vollhartmetall bestehen bleiben. Die Stabilität der Schnittstelle beruht unter anderem auf der Dreischneidigkeit, die prädestiniert ist für ein Wechselkopfsystem.

Durch die drei Schneiden ist die Belastung der Schnittstelle homogen, das heißt die Kräfte, die bei der Zerspanung entstehen, werden gleichmäßig an den Werkzeughalter aus Stahl übertragen. Zudem garantiert die Schnittstelle optimale Drehmomentübertragung bei gleichzeitig hoher Wechsel- und Rundlaufgenauigkeit.

Gegenüber zweischneidigen Wechselkopfborschern aus Vollhartmetall können mit dem TTD-Tritan bis zu doppelt so hohe Vorschübe realisiert werden.

Im Ergebnis kann prozesssicher und stabil auch bei schwierigen Bohrsituationen, wie bei schrägem Bohrungseintritt oder bei Querbohrungen, gearbeitet werden. Das Werkzeug zentriert sich optimal über seine ausgeprägte Bohrspitze und sorgt für sehr gute Rundheit. Und das zu geringeren Kosten als bei Vollhartmetallbohrern. Denn mit dem neuen Wechselkopfsystem ist das kostenintensive Hartmetall auf den Werkzeugkopf beschränkt. So sind geringere Kosten auch bei großen Durchmessern garantiert.

Werkzeugfeatures im Detail

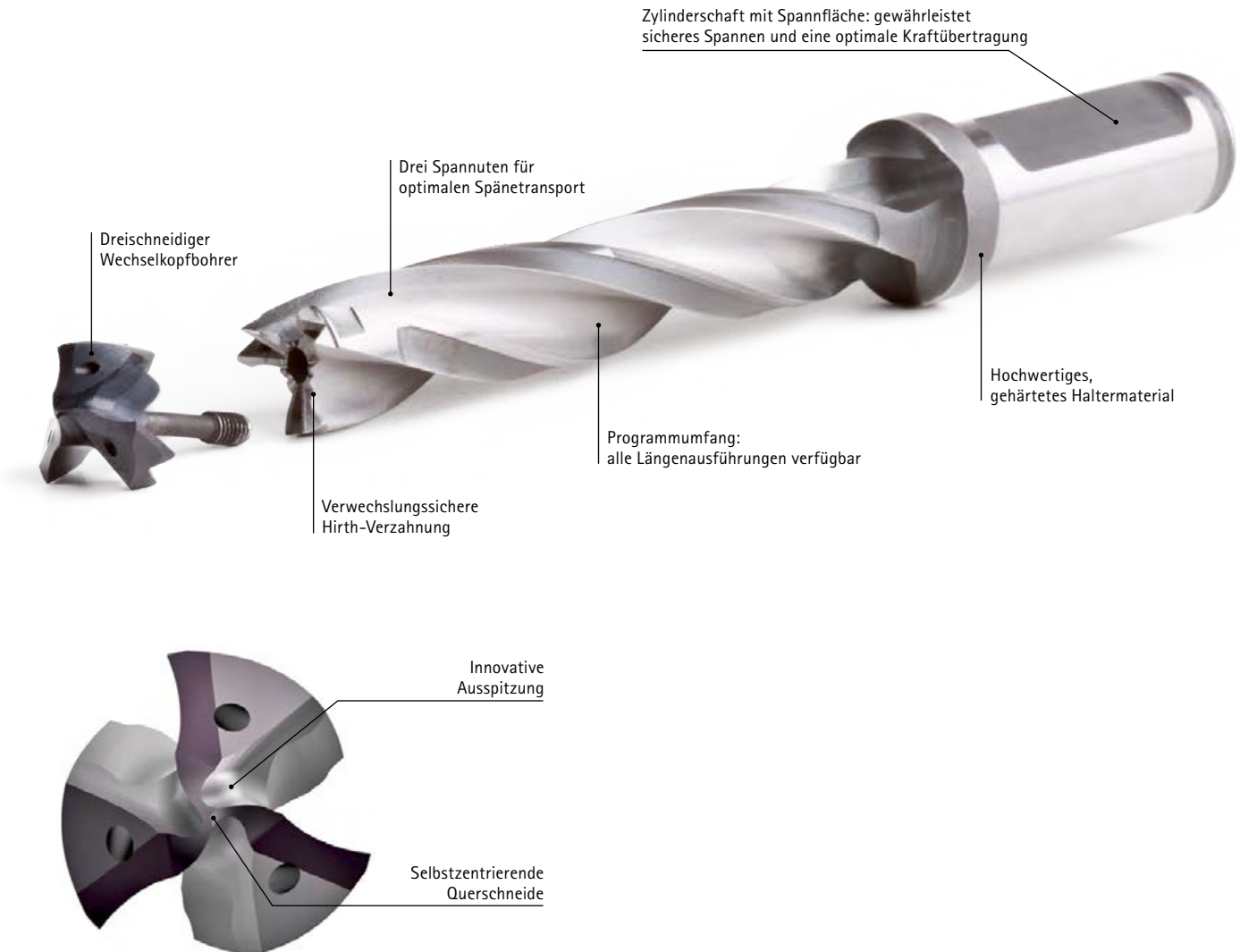

AUF EINEN BLICK

- Dreischneidiger Wechselkopfbohrer
- \varnothing -Bereich 12,00 bis 32,49 mm
- Bohrtiefen 3 | 5 und 8xD
- Mit Innenkühlung
- Einfaches Handling
- Kopfwechsel in der Maschine möglich

LEISTUNGSMERKMALE

- Bis zu doppelter Vorschub gegenüber zweischneidigen Wechselkopfbohrern
- Hohe Wechsel- und Rundlaufgenauigkeit
- Optimal bei schrägem Bohrungseintritt
- Werkzeug zentriert sich über seine ausgeprägte Bohrerspitze
- Hohe Drehmomentübertragung

VORTEILE

- Signifikante Steigerungen von Vorschubgeschwindigkeit und Standweg
- Tritan-Geometrie für gute Bohrungsergebnisse
- Hohe Prozesssicherheit und Stabilität auch bei schwierigen Bohrsituationen
- Homogene Belastung der Schnittstelle durch drei Schneiden

Wechselbohrkopf TTD-Tritan

Aus Vollhartmetall, innere Kühlmittelzufuhr
Typ 01 - Uni

Ausführung:
Bohrerdurchmesser: 12,00 – 32,49 mm
Bohrungstoleranz: IT 9 (erreichbar)
Schneidstoff: HP926
Schneidenanzahl: 3
Anzahl Führungsfasen: 3
Spitzenwinkel: 140°

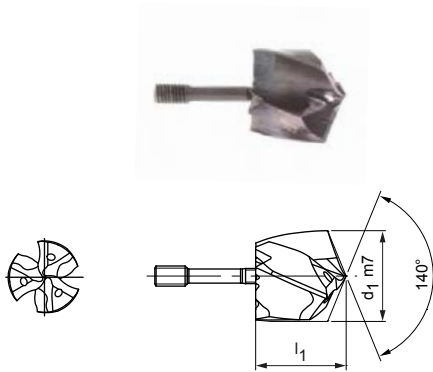

Lagerhaltige Vorzugsbaureihe

d ₁ von 13,50 bis 20,00		
d ₁ m7	Spezifikation	Bestell-Nr.
13,50	TTD300-3F01-1350-HP926	30871173
14,00	TTD300-3F01-1400-HP926	30871178
14,40	TTD300-3F01-1440-HP926	30871182
14,60	TTD300-3F01-1460-HP926	30871184
15,00	TTD300-3F01-1500-HP926	30871188
15,10	TTD300-3F01-1510-HP926	30871189
15,20	TTD300-3F01-1520-HP926	30871190
15,38	TTD300-3F01-1538-HP926	31290822
15,40	TTD300-3F01-1540-HP926	30871192
16,00	TTD300-3F01-1600-HP926	30871198
16,50	TTD300-3F01-1650-HP926	30871203
17,00	TTD300-3F01-1700-HP926	30871209
17,50	TTD300-3F01-1750-HP926	30871214
18,00	TTD300-3F01-1800-HP926	30871219
18,50	TTD300-3F01-1850-HP926	30871224
19,00	TTD300-3F01-1900-HP926	30871229
19,80	TTD300-3F01-1980-HP926	30871237
20,00	TTD300-3F01-2000-HP926	30871239

d ₁ von 20,50 bis 32,00		
d ₁ m7	Spezifikation	Bestell-Nr.
20,50	TTD300-3F01-2050-HP926	30871244
21,00	TTD300-3F01-2100-HP926	30871249
22,00	TTD300-3F01-2200-HP926	30871259
24,00	TTD300-3F01-2400-HP926	30871279
24,70	TTD300-3F01-2470-HP926	30871287
25,00	TTD300-3F01-2500-HP926	30871290
25,10	TTD300-3F01-2510-HP926	30871291
25,20	TTD300-3F01-2520-HP926	30871292
26,00	TTD300-3F01-2600-HP926	30871300
26,10	TTD300-3F01-2610-HP926	30871301
26,50	TTD300-3F01-2650-HP926	30871305
27,00	TTD300-3F01-2700-HP926	30871310
27,10	TTD300-3F01-2710-HP926	30871311
28,00	TTD300-3F01-2800-HP926	30871320
28,50	TTD300-3F01-2850-HP926	30871325
31,00	TTD300-3F01-3100-HP926	30871350
32,00	TTD300-3F01-3200-HP926	30871360

Konfigurierbare Merkmale



Durchmesser:
Durchmesser in Abstufungen von 0,01 mm frei wählbar

Spezifikation:
TTD300-3F01-[Durchmesser]-HP929

Abmessungen konfigurierbare Baureihe

d ₁ min.	d ₁ max.
12,00	32,49

Beispiel:
TTD300-4F03-1401-HP619

Werkzeugdurchmesser d₁ = 14,01 mm

Maßangaben in mm.
Schnittwertempfehlung siehe Kapitelende.
Sonderausführungen und andere Beschichtungen auf Anfrage.

Wechselkopfhalter TTS

TTS300 mit Axialspannsystem für Wechselkopfbohrer TTD-Tritan (3xD),
innere Kühlmittelzufuhr

Ausführung:

Bohrerdurchmesser: 12,00 – 32,49 mm
Wechselsystem: Zentrale Spannung
über Kühlmittel-
bohrung

Anmerkung:

Montageschlüssel im Lieferumfang enthalten.

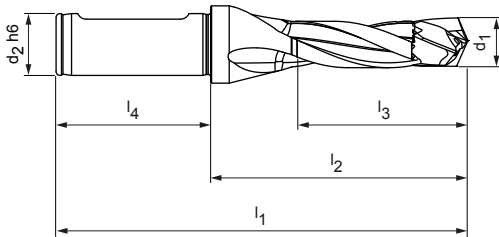

Lagerhaltige Vorzugsbaureihe

Baumaße						Schaftform HB	
d ₁	d ₂ h6	l ₁	l ₂	l ₃	l ₄	Spezifikation	Bestell-Nr.
14,00 - 14,49	16	120	72	48	48	TTS300B-1400-DR3-ZYL-16-MN	30839684
14,50 - 14,99	16	122	74	49	48	TTS300B-1450-DR3-ZYL-16-MN	30839685
15,00 - 15,49	16	124	76	51	48	TTS300B-1500-DR3-ZYL-16-MN	30839686
17,50 - 18,49	20	140	90	61	50	TTS300B-1750-DR3-ZYL-20-MN	30839689
18,50 - 19,49	25	150	94	64	56	TTS300B-1850-DR3-ZYL-25-MN	30839690
20,50 - 21,49	25	159	103	71	56	TTS300B-2050-DR3-ZYL-25-MN	30839692
21,50 - 22,49	25	164	108	74	56	TTS300B-2150-DR3-ZYL-25-MN	30839693
24,50 - 25,49	32	182	122	84	60	TTS300B-2450-DR3-ZYL-32-MN	30839696
26,50 - 27,49	32	191	131	91	60	TTS300B-2650-DR3-ZYL-32-MN	30839698

Auf Anfrage erhältlich

Baumaße						Schaftform HB	
d ₁	d ₂ h6	l ₁	l ₂	l ₃	l ₄	Spezifikation	Bestell-Nr.
12,00 - 12,49	16	111	63	39	48	TTS300B-1200-DR3-ZYL-16-MN	30839680
12,50 - 12,99	16	113	65	43	48	TTS300B-1250-DR3-ZYL-16-MN	30839681
13,00 - 13,49	16	115	67	45	48	TTS300B-1300-DR3-ZYL-16-MN	30839682
13,50 - 13,99	16	117	69	46	48	TTS300B-1350-DR3-ZYL-16-MN	30839683
15,50 - 16,49	20	131	81	54	50	TTS300B-1550-DR3-ZYL-20-MN	30839687
16,50 - 17,49	20	135	85	58	50	TTS300B-1650-DR3-ZYL-20-MN	30839688
19,50 - 20,49	25	155	99	68	56	TTS300B-1950-DR3-ZYL-25-MN	30839691
22,50 - 23,49	25	168	112	78	56	TTS300B-2250-DR3-ZYL-25-MN	30839694
23,50 - 24,49	25	173	117	81	56	TTS300B-2350-DR3-ZYL-25-MN	30839695
25,50 - 26,49	32	186	126	87	60	TTS300B-2550-DR3-ZYL-32-MN	30839697
27,50 - 28,49	32	195	135	94	60	TTS300B-2750-DR3-ZYL-32-MN	30839699
28,50 - 29,49	32	200	140	97	60	TTS300B-2850-DR3-ZYL-32-MN	30839700
29,50 - 30,49	32	204	144	101	60	TTS300B-2950-DR3-ZYL-32-MN	30839701
30,50 - 31,49	32	209	149	104	60	TTS300B-3050-DR3-ZYL-32-MN	30839702
31,50 - 32,49	32	213	153	107	60	TTS300B-3150-DR3-ZYL-32-MN	30839703

Maßangaben in mm.

Sonderausführungen auf Anfrage.

Wechselkopfhalter TTS

TTS300 mit Axialspannsystem für Wechselkopfbohrer TTD-Tritan (5xD),
innere Kühlmittelzufuhr

Ausführung:

Bohrerdurchmesser: 12,00 – 32,49 mm
Wechselsystem: Zentrale Spannung
über Kühlmittel-
bohrung

Anmerkung:

Montageschlüssel im Lieferumfang enthalten.

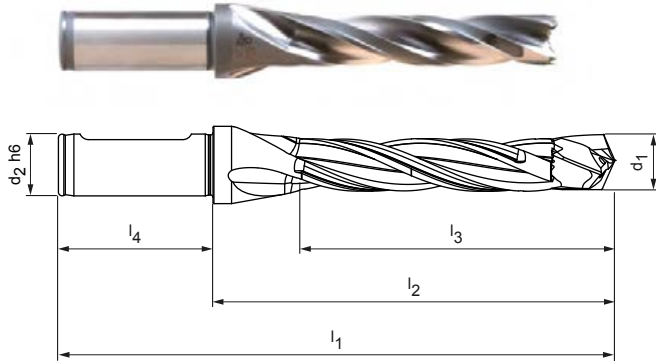

Lagerhaltige Vorzugsbaureihe

Baumaße						Schaftform HB	
d ₁	d ₂ h6	l ₁	l ₂	l ₃	l ₄	Spezifikation	Bestell-Nr.
14,00 - 14,49	16	149	101	77	48	TTS300B-1400-DR5-ZYL-16-MN	30839708
15,00 - 15,49	16	155	107	82	48	TTS300B-1500-DR5-ZYL-16-MN	30839710
16,50 - 17,49	20	170	120	93	50	TTS300B-1650-DR5-ZYL-20-MN	30839712
17,50 - 18,49	20	177	127	98	50	TTS300B-1750-DR5-ZYL-20-MN	30839713
23,50 - 24,49	25	222	166	130	56	TTS300B-2350-DR5-ZYL-25-MN	30839719
24,50 - 25,49	32	233	173	135	60	TTS300B-2450-DR5-ZYL-32-MN	30839720
26,50 - 27,49	32	246	186	146	60	TTS300B-2650-DR5-ZYL-32-MN	30839722

Auf Anfrage erhältlich

Baumaße						Schaftform HB	
d ₁	d ₂ h6	l ₁	l ₂	l ₃	l ₄	Spezifikation	Bestell-Nr.
12,00 - 12,49	16	136	88	66	48	TTS300B-1200-DR5-ZYL-16-MN	30839704
12,50 - 12,99	16	139	91	69	48	TTS300B-1250-DR5-ZYL-16-MN	30839705
13,00 - 13,49	16	142	94	71	48	TTS300B-1300-DR5-ZYL-16-MN	30839706
13,50 - 13,99	16	145	97	74	48	TTS300B-1350-DR5-ZYL-16-MN	30839707
14,50 - 14,99	16	152	104	79	48	TTS300B-1450-DR5-ZYL-16-MN	30839709
15,50 - 16,49	20	164	114	87	50	TTS300B-1550-DR5-ZYL-20-MN	30839711
18,50 - 19,49	25	189	133	103	56	TTS300B-1850-DR5-ZYL-25-MN	30839714
19,50 - 20,49	25	196	140	109	56	TTS300B-1950-DR5-ZYL-25-MN	30839715
20,50 - 21,49	25	202	146	114	56	TTS300B-2050-DR5-ZYL-25-MN	30839716
21,50 - 22,49	25	209	153	119	56	TTS300B-2150-DR5-ZYL-25-MN	30839717
22,50 - 23,49	25	215	159	124	56	TTS300B-2250-DR5-ZYL-25-MN	30839718
25,50 - 26,49	32	239	179	140	60	TTS300B-2550-DR5-ZYL-32-MN	30839721
27,50 - 28,49	32	252	192	151	60	TTS300B-2750-DR5-ZYL-32-MN	30839723
28,50 - 29,49	32	259	199	156	60	TTS300B-2850-DR5-ZYL-32-MN	30839724
29,50 - 30,49	32	265	205	162	60	TTS300B-2950-DR5-ZYL-32-MN	30839725
30,50 - 31,49	32	272	212	167	60	TTS300B-3050-DR5-ZYL-32-MN	30839726
31,50 - 32,49	32	278	218	172	60	TTS300B-3150-DR5-ZYL-32-MN	30839727

Maßangaben in mm.

Sonderausführungen auf Anfrage.

Wechselkopfhalter TTS

TTS300 mit Axialspannsystem für Wechselkopfbohrer TTD-Tritan (8xD),
innere Kühlmittelzufuhr

Ausführung:

Bohrerdurchmesser: 12,00 – 32,49 mm
Wechselsystem: Zentrale Spannung
über Kühlmittel-
bohrung

Anmerkung:

Montageschlüssel im Lieferumfang enthalten.

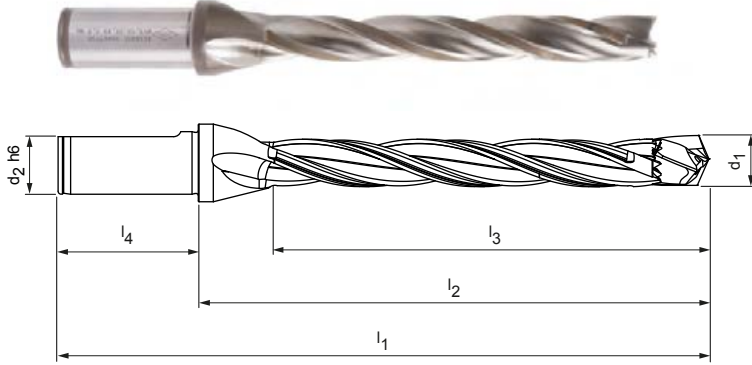

Lagerhaltige Vorzugsbaureihe

Baumaße						Schaftform HB	
d ₁	d ₂ h6	l ₁	l ₂	l ₃	l ₄	Spezifikation	Bestell-Nr.
15,50 - 16,49	20	213	163	137	50	TTS300B-1550-DR8-ZYL-20-MN	30867702
20,50 - 21,49	25	267	211	178	56	TTS300B-2050-DR8-ZYL-25-MN	30867707

Auf Anfrage erhältlich

Baumaße						Schaftform HB	
d ₁	d ₂ h6	l ₁	l ₂	l ₃	l ₄	Spezifikation	Bestell-Nr.
12,00 - 12,49	16	173	125	104	48	TTS300B-1200-DR8-ZYL-16-MN	30867695
12,50 - 12,99	16	178	130	108	48	TTS300B-1250-DR8-ZYL-16-MN	30867696
13,00 - 13,49	16	183	135	112	48	TTS300B-1300-DR8-ZYL-16-MN	30867697
13,50 - 13,99	16	187	139	116	48	TTS300B-1350-DR8-ZYL-16-MN	30867698
14,00 - 14,49	16	192	144	120	48	TTS300B-1400-DR8-ZYL-16-MN	30867699
14,50 - 14,99	16	197	149	124	48	TTS300B-1450-DR8-ZYL-16-MN	30867700
15,00 - 15,49	16	202	154	129	48	TTS300B-1500-DR8-ZYL-16-MN	30867701
16,50 - 17,49	20	223	173	145	50	TTS300B-1650-DR8-ZYL-20-MN	30867703
17,50 - 18,49	20	232	182	153	50	TTS300B-1750-DR8-ZYL-20-MN	30867704
18,50 - 19,49	25	248	192	162	56	TTS300B-1850-DR8-ZYL-25-MN	30867705
19,50 - 20,49	25	257	201	170	56	TTS300B-1950-DR8-ZYL-25-MN	30867706
21,50 - 22,49	25	276	220	187	56	TTS300B-2150-DR8-ZYL-25-MN	30867708
22,50 - 23,49	25	286	230	195	56	TTS300B-2250-DR8-ZYL-25-MN	30867709
23,50 - 24,49	25	295	239	203	56	TTS300B-2350-DR8-ZYL-25-MN	30867710
24,50 - 25,49	32	309	249	212	60	TTS300B-2450-DR8-ZYL-32-MN	30867711
25,50 - 26,49	32	319	259	220	60	TTS300B-2550-DR8-ZYL-32-MN	30885879
26,50 - 27,49	32	328	268	228	60	TTS300B-2650-DR8-ZYL-32-MN	30867713
27,50 - 28,49	32	338	278	236	60	TTS300B-2750-DR8-ZYL-32-MN	30867714
28,50 - 29,49	32	342	282	245	60	TTS300B-2850-DR8-ZYL-32-MN	30867715
29,50 - 30,49	32	352	292	253	60	TTS300B-2950-DR8-ZYL-32-MN	30867716
30,50 - 31,49	32	361	301	261	60	TTS300B-3050-DR8-ZYL-32-MN	30867717
31,50 - 32,49	32	371	311	270	60	TTS300B-3150-DR8-ZYL-32-MN	30867718

Maßangaben in mm.

Sonderausführungen auf Anfrage.



Zubehör und Ersatzteile für TTD-Tritan



TORX®-Schlüssel

Durchmesserbereich Wechselbohrkopf TTD-Tritan	Torx	Anzugsdrehmoment Spezials- pannschraube [Nm]	Bestell-Nr.
			für Halterlänge 3xD, 5xD und 8xD
12,00 - 12,49	6	0,4	30890316
12,50 - 12,99			
13,00 - 13,49			
13,50 - 13,99			
14,00 - 14,49	7	0,7	30890318
14,50 - 14,99			
15,00 - 15,49			
15,50 - 16,49			
16,50 - 17,49	8	1,3	30890321
17,50 - 18,49			
18,50 - 19,49			
19,50 - 20,49			
20,50 - 21,49	10	2	30890323
21,50 - 22,49			
22,50 - 23,49			
23,50 - 24,49			
24,50 - 25,49	15	3,1	30890326
25,50 - 26,49			
26,50 - 27,49			
27,50 - 28,49		5,6	
28,50 - 29,49			
29,50 - 30,49			
30,50 - 31,49			
31,50 - 32,49			

Drehmomentschlüssel

Zubehör	Anzugsdrehmomentbereich [Nm]	Bestell-Nr.
Drehmomentschlüssel 	0,2 – 1,2	30911425
Drehmomentschlüssel 	1,0 – 6,0	30911426

Griff für TORX®-Schlüssel

Erstatzteil	Einsteckschaft	Bestell-Nr.
Multi-Griff 	Innensechskant 1/4"	30918896

Schnittwertempfehlung für Wechselkopfbohrer TTD-Tritan

Vorschub und Schnittgeschwindigkeit

Typ 01 – Uni

MZG*	Werkstoff	Festigkeit/Härte [N/mm ²] [HRC]
P	P1.1 Bau-, Automaten-, Einsatz- und Vergütungsstähle, unlegiert	< 700
	P1.2 Bau-, Automaten-, Einsatz- und Vergütungsstähle, unlegiert	< 1.200
	P2.1 Nitrier-, Einsatz- und Vergütungsstähle, legiert	< 900
	P2.2 Nitrier-, Einsatz- und Vergütungsstähle, legiert	< 1.400
	P3.1 Werkzeug-, Wälzlager-, Feder- und Schnellarbeitsstähle**	< 800
	P3.2 Werkzeug-, Wälzlager-, Feder- und Schnellarbeitsstähle**	< 1.000
	P3.3 Werkzeug-, Wälzlager-, Feder- und Schnellarbeitsstähle**	< 1.500
	P5.1 Stahlguss	
K	K1.1 Gusseisen mit Lamellengraphit (Grauguss), GJL	< 300
	K2.1 Gusseisen mit Kugelgraphit, GJS	< 500
	K2.2 Gusseisen mit Kugelgraphit, GJS	≤ 800
	K2.3 Gusseisen mit Kugelgraphit, GJS	> 800
	K3.1 Gusseisen mit Vermiculargraphit, GJV; Temperguss, GJM	< 500
	K3.2 Gusseisen mit Vermiculargraphit, GJV; Temperguss, GJM	> 500

* MAPAL Zerspanungsgruppen

** Wenn die Legierungsbestandteile Cr, Mo, Ni, V, W in Summe > 8 %, dann die nächst höhere MAPAL Zerspanungsgruppe wählen.

	Schnittgeschwindigkeit v_c [m/min]				Vorschub f [mm] bei Bohrerdurchmesser					
	Innenkühlung	Außenkühlung	MMS	Luft	12,00	14,50	17,50	21,50	26,00	32,00
	90	80	80		0,38	0,42	0,46	0,50	0,53	0,54
	80	70	70		0,47	0,53	0,58	0,63	0,66	0,68
	90	75	75		0,45	0,50	0,55	0,59	0,62	0,64
	65	55	55		0,36	0,40	0,43	0,47	0,49	0,51
	70	60	60		0,40	0,45	0,49	0,53	0,56	0,58
	55	50	50		0,33	0,37	0,40	0,43	0,46	0,47
	55	40	45		0,26	0,28	0,31	0,33	0,35	0,36
	90	75	75		0,45	0,50	0,55	0,59	0,62	0,64
	110	75	75	75	0,62	0,69	0,77	0,83	0,88	0,90
	145	90	110	110	0,57	0,64	0,71	0,77	0,81	0,83
	90	70	70		0,49	0,55	0,61	0,66	0,69	0,71
	55	35	45		0,33	0,37	0,40	0,43	0,46	0,47
	80	70	70		0,53	0,59	0,65	0,71	0,75	0,77
	70	65	65		0,43	0,47	0,52	0,56	0,59	0,61

Die angegebenen Schnittwerte sind Richtwerte.

Die für den jeweiligen Bearbeitungsfall optimalen Daten sollten im Versuch oder während der Bearbeitung ermittelt werden.



VOLLBOHREN MIT WENDESCHNEID- PLATTEN

Vollbohren mit Wendeschneidplatten

Wendeschneidplattenbohrer 240

Radial-Wendeschneidplatte WOGT, dreischneidig 241

Technischer Anhang

Schnittwertempfehlung für Wendeschneidplattenbohrer 242

Anwendungshinweise 744

VOLLBOHREN MIT WENDESCHNEIDPLATTEN

Die Wendeschneidplatten zum Vollbohren von Aluminium überzeugen mit drei nutzbaren Schneidkanten und einer leistungsstarken CVD-Diamantbeschichtung. Die Schneiden sind in fünf Größen verfügbar. So ist ihr Einsatz in einem sehr breiten Anwendungsspektrum möglich.

Die ein- oder mehrstufigen Sonderwerkzeuge zeichnen sich durch eine extrem hohe Wirtschaftlichkeit und einfaches Handling aus.



Aus der Praxis

Material: AISi1 v_c : 800 - 1000 m/min
 Durchmesser: 39,0 mm f : 0,30 - 0,45 mm
 Bohrtiefe: 65 mm

Standweg pro Schneidkante

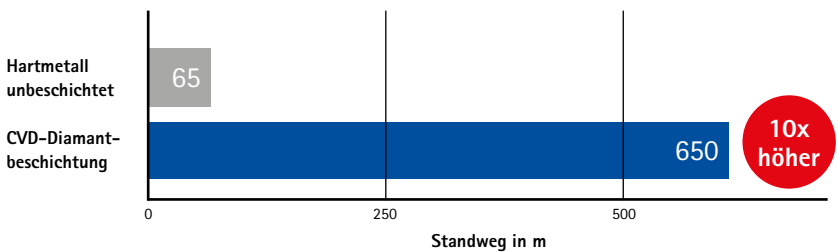

AUF EINEN BLICK

- Kundenspezifische Lösungen für: \varnothing 16 - 54,9 mm
- Vollbohren von AISi1 bis AISi12
- Mit Innenkühlung, auch MMS möglich
- Ein- oder mehrstufig mit Wendeschneidplatten- oder PKD-Aufbohrstufe

VORTEILE

- Extrem wirtschaftlich bei höchster Produktivität
- Breites Anwendungsspektrum
- Einfaches Handling



Fünf Wendeschneidplattengrößen für den Durchmesserbereich 16 bis 54,9 mm.

WOGT

Radial-Wendeschneidplatte, dreischneidig



	Hartmetall	
Werkstoff	N	
	Al leg. ← verschleißfest	→ Cu leg. zäh
Schneidstoffsorte	HC698	
Schneidkantenausführung	X40	

ø-Bereich [mm]

WOGT030206N-...-...	16,0 - 20,9	31033174
WOGT040206N-...-...	21,0 - 25,9	31033175
WOGT053006N-...-...	26,0 - 30,9	31033177
WOGT063008N-...-...	31,0 - 44,9	30787196
WOGT073808N-...-...	45,0 - 54,9	31033178

Bezeichnungsschlüssel siehe Seite 676.

Schneidstoffübersicht siehe Seite 672.

Zubehör für Radial-Wendeschneidplatten

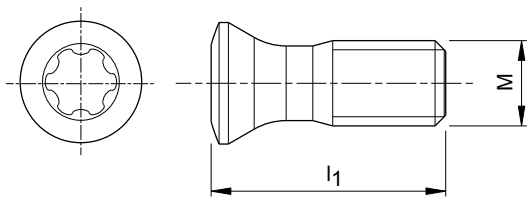

WSP	WSP-Größe	Spannschraube					Schraubendreher
		Abmessung [MxI]	Bezeichnung	Anzugsdrehmoment [Nm]	Torxgröße	Bestell-Nr.	Bestell-Nr.
WOGT... 	0302	M2x4.95	MN659 M2x4.95-TX6-IP	0,4	TX6-IP	10002712	30414758
	0402	M2.2x6	MN659 M2.2x6-TX7-IP	0,9	TX7-IP	31074485	30414759
	0530	M3x8.5	MN659 M3x8.5-TX8-IP	1,5	TX8-IP	31074486	30414760
	0630	M3.5x9	MN659 M3.5x9-TX15-IP	2,8	TX15-IP	10105078	30414764
	0738	M4x9.4	MN659 M4x9.4-TX15-IP	3,5	TX15-IP	30480629	30414764

Schnittwertempfehlung für Wendeschneidplattenbohrer

Vorschub und Schnittgeschwindigkeit

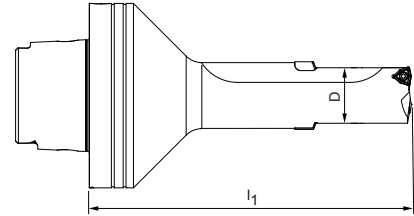

Wendeschneidplattenbohrer

Startwerte für Schnittgeschwindigkeit und Vorschub mit WOGT...-X40-HC698

MZG*	Werkstoff	Festigkeit/Härte [N/mm ²] [HRC]
N1	N1.1 Aluminium, unlegiert und legiert < 3 % Si	
	N1.2 Aluminium, legiert ≤ 7 % Si	
	N1.3 Aluminium, legiert > 7-12 % Si	
	N1.4 Aluminium, legiert > 12 % Si	
N2	N2.1 Kupfer, unlegiert und niedriglegiert	< 300
	N2.2 Kupfer, legiert	> 300
	N2.3 Messing, Bronze, Rotguss	< 1.200
N3	N3.1 Graphit	
N4	N4.1 Kunststoff, Thermoplaste	
	N4.2 Kunststoff, Duroplaste	
	N4.3 Kunststoff, Schaumstoffe	

Korrekturfaktor:

Anbohren/Austritt des Bohrers

l_1	v_c	f_z
3xD	0,8	0,7
4xD	0,7	0,6
5xD	0,6	0,5

	Schnittgeschwindigkeit v_c [m/min]	Vorschub f [mm] bei Bohrerdurchmesserbereich [mm]				
		16,00 - 20,90	21,00 - 25,90	26,00 - 30,90	31,00 - 44,90	45,00 - 54,90
	300 - 1.000	0,08 - 0,20	0,12 - 0,22	0,14 - 0,30	0,16 - 0,40	0,20 - 0,45
	230 - 900	0,06 - 0,18	0,10 - 0,20	0,12 - 0,25	0,14 - 0,30	0,18 - 0,35
	220 - 800	0,05 - 0,15	0,08 - 0,18	0,10 - 0,20	0,12 - 0,25	0,15 - 0,30
	200 - 700	0,05 - 0,15	0,08 - 0,18	0,10 - 0,20	0,12 - 0,25	0,15 - 0,30

Die angegebenen Schnittwerte sind Richtwerte.

Die für den jeweiligen Bearbeitungsfall optimalen Daten sollten im Versuch oder während der Bearbeitung ermittelt werden.



ANBOHREN

Anbohrer

Tritan-Spot-Drill-Steel	246
ECU-Centre-Drill	248
CPD-Spot-Drill	249
CFS-Wechselkopfhalter	250

Technischer Anhang

Schnittwertempfehlung	251
-----------------------------	-----

Tritan-Spot-Drill-Steel

Vollhartmetall-NC-Anbohrer
SCD670, äußere Kühlmittelzufuhr

Ausführung:
Bohrerdurchmesser: 4,00 – 20,00 mm
Schaftform: HA (DIN 6535)
Schneidstoff: HP358
Schneidenanzahl: 3
Spitzenwinkel: 155°

Anwendung:
Spezieller NC-Anbohrer für den Tritan-Drill-Steel.

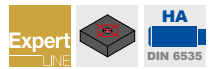
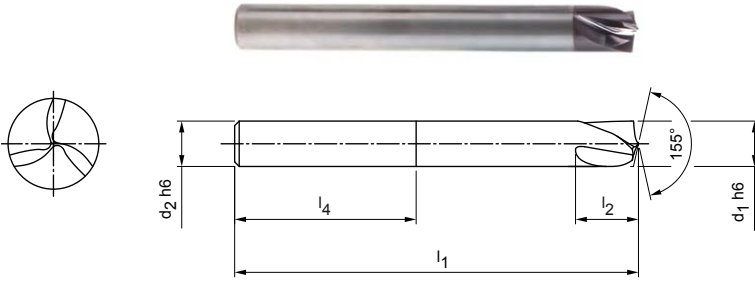

Lagerhaltige Vorzugsbaureihe

Baumaße					Schaftform HA	
d ₁ h6	d ₂ h6	l ₁	l ₂	l ₄	Spezifikation	Bestell-Nr.
4,00	4	55	6	28	SCD670-0400-3-0-155HA-HP358	30980587
5,00	6	62	7	36	SCD670-0500-3-0-155HA-HP358	30980588
6,00	6	66	9	36	SCD670-0600-3-0-155HA-HP358	30980589
8,00	8	79	11	36	SCD670-0800-3-0-155HA-HP358	30980590
10,00	10	89	14	40	SCD670-1000-3-0-155HA-HP358	30980592
12,00	12	102	17	45	SCD670-1200-3-0-155HA-HP358	30980594
16,00	16	115	23	48	SCD670-1600-3-0-155HA-HP358	30980595
20,00	20	131	28	50	SCD670-2000-3-0-155HA-HP358	30980596

Anbohrtiefen

d ₁ h6	d ₂ h6	l ₁	l ₂	l ₄	Maximale Anbohrtiefe *	Minimale Anbohrtiefe **
4,00	4	55	6	28	0,40	0,24
5,00	6	62	7	36	0,50	0,30
6,00	6	66	9	36	0,60	0,36
8,00	8	79	11	36	0,80	0,48
10,00	10	89	14	40	1,00	0,60
12,00	12	102	17	45	1,20	0,72
16,00	16	115	23	48	1,60	0,96
20,00	20	131	28	50	2,00	1,20

* 10 % der Nenn-Ø

** 6 % der Nenn-Ø

Maßangaben in mm.

Schnittwertempfehlung siehe Kapitelende.

Sonderausführungen und andere Beschichtungen auf Anfrage.

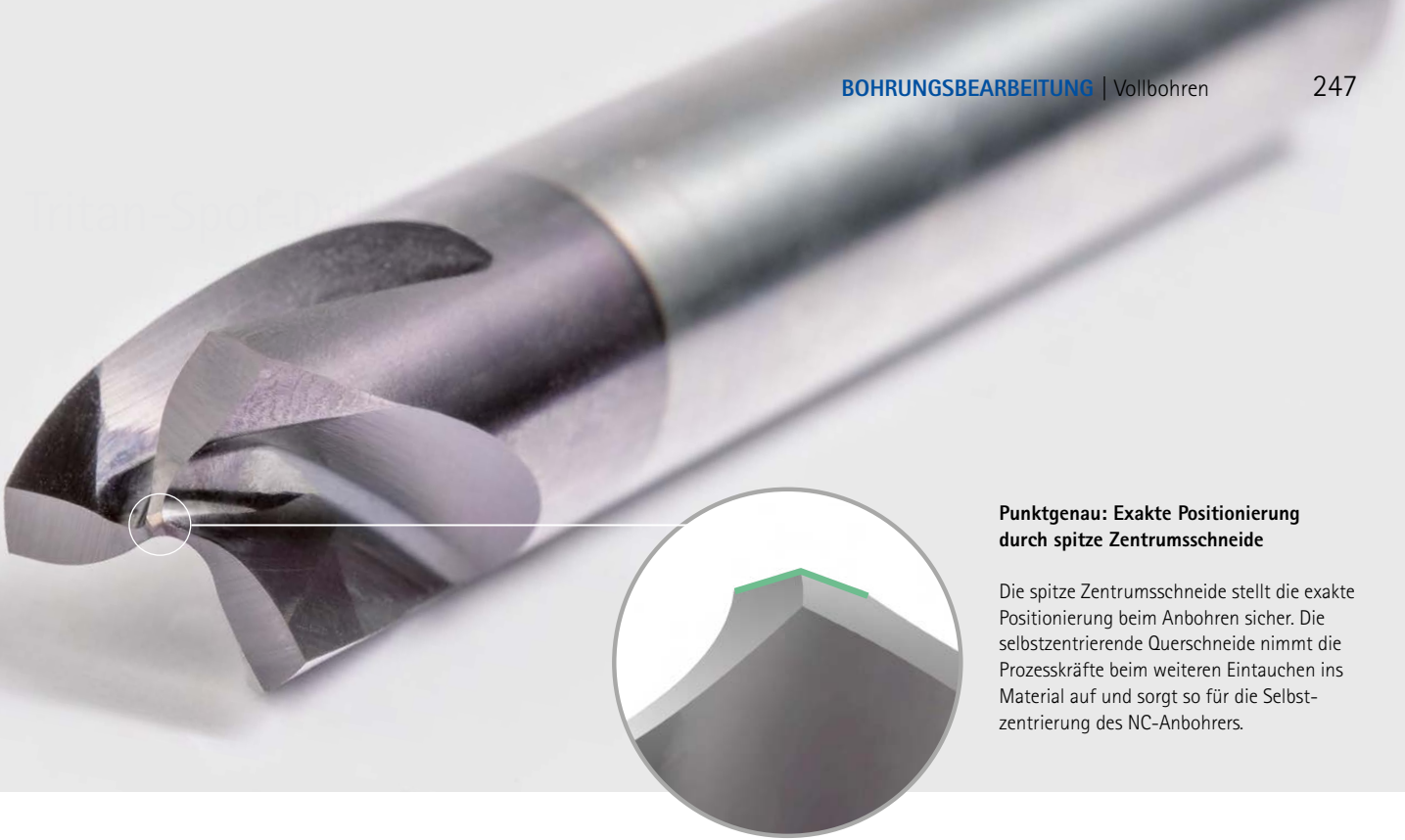

Punktgenau: Exakte Positionierung durch spitze Zentrumschneide

Die spitze Zentrumschneide stellt die exakte Positionierung beim Anbohren sicher. Die selbstzentrierende Querschneide nimmt die Prozesskräfte beim weiteren Eintauchen ins Material auf und sorgt so für die Selbstzentrierung des NC-Anbohrers.

Tritan-Drill-Steel



Die Spitzenwinkel des Tritan-Spot-Drill-Steel (155°) und des Tritan-Drill-Steel (140°/145°) sind perfekt aufeinander abgestimmt.

Der Tritan-Drill-Steel ist erhältlich in:



Bohrstrategie 3xD bis 12xD:

Maximale Anbohrtiefe: 10 %
(%-Angabe des
Nenndurchmessers)

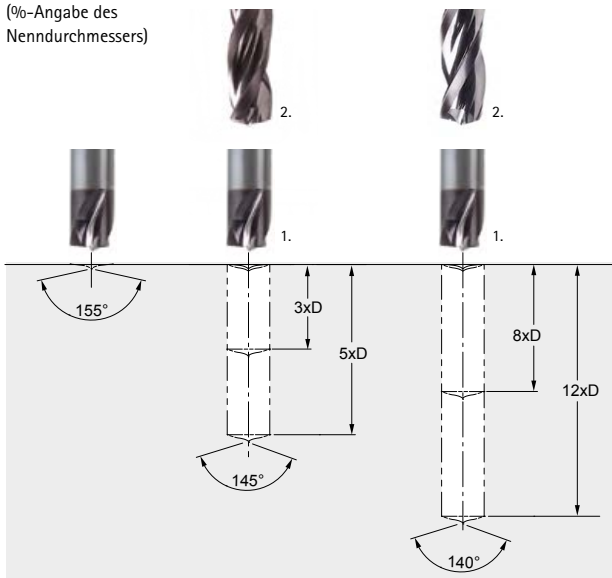

AUF EINEN BLICK

- Dreischneidiger NC-Anbohrer mit 155° Spitzenwinkel
- Perfekt auf den Tritan-Drill-Steel abgestimmt
- Hohe Positionsgenauigkeit
- Selbstzentrierende Querschneide
- Geeignet auch für schwierige Bohrsituationen

ECU-Centre-Drill

Vollhartmetall-Zentrierbohrer
SCD450

Ausführung:

Bohrerdurchmesser: 0,50 – 2,50 mm
Schneidstoff: HU318
Schneidenanzahl: 2
Anzahl Führungsfasen: 2
Spitzenwinkel: 120°/60°
Spiralwinkel: 5°

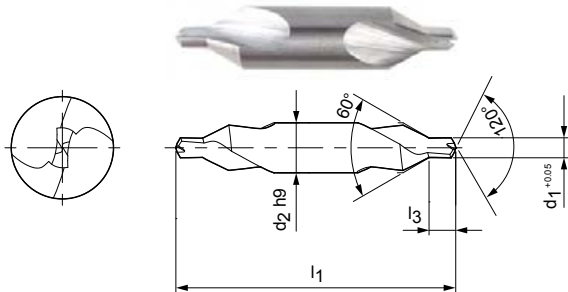

Lagerhaltige Vorzugsbaureihe

Baumaße				Spezifikation	Bestell-Nr.
d_1 (0 +0,05)	d_2 h9	l_1	l_3		
0,50*	3,15	20	0,8	SCD450-0050-2-2-120HA-HU318	30561506
0,80*	3,15	20	1,1	SCD450-0080-2-2-120HA-HU318	30561507
1,00	3,15	31,5	1,3	SCD450-0100-2-2-120HA-HU318	30561508
1,25	3,15	31,5	1,6	SCD450-0125-2-2-120HA-HU318	30561509
1,60	4	35,5	2	SCD450-0160-2-2-120HA-HU318	30561510
2,00	5	40	2,5	SCD450-0200-2-2-120HA-HU318	30561511
2,50	6,3	45	3,1	SCD450-0250-2-2-120HA-HU318	30561512

Maßangaben in mm.

* Einseitig schneidend.

Schnittwertempfehlung siehe Kapitelende.

Sonderausführungen und andere Beschichtungen auf Anfrage.

CPD-Spot-Drill

Ausführung mit CFS-Trennstelle
CPD100

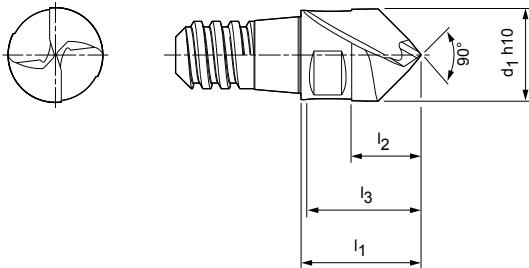

Lagerhaltige Vorzugsbaureihe

Baumaße					z	a _p max.	SW	Spezifikation	Bestell-Nr.
d ₁ h10	CFS-Größe	l ₁	l ₂	l ₃					
8,00	6	11	6	10	2	4	SW 6	CPD100-0800Z02-W090-06-HP338	30371388
10,00	8	13	7,5	12	2	5	SW 8	CPD100-1000Z02-W090-08-HP338	30371389
12,00	10	16	9	15	2	6	SW 10	CPD100-1200Z02-W090-10-HP338	30371390
16,00	12	20	12	18	2	8	SW 13	CPD100-1600Z02-W090-12-HP338	30371391
20,00	16	25	15	23	2	10	SW 16	CPD100-2000Z02-W090-16-HP338	30371393

Zubehör

	CFS-Wechselkopfhalter CFS201	Seite 250
---	---------------------------------	-----------

Maßangaben in mm.

Schnittwertempfehlung siehe Kapitelende.

Sonderausführungen und andere Beschichtungen auf Anfrage.

CFS-Wechselkopfhalter

Konische Ausführung, mit Innenkühlung

CFS201

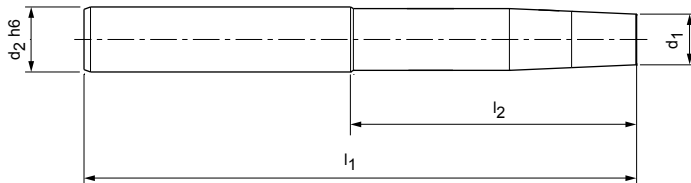

Ausführung aus Stahl

CFS Größe	Baumaße				Spezifikation	Bestell-Nr.
	d ₁	d ₂ h6	l ₁	l ₂		
6	7,8	10	60	20	CFS201N-06-020-ZYL-HA10-S	30393776
8	9,8	16	70	30	CFS201N-08-030-ZYL-HA16-S	30393787
8	9,8	16	90	40	CFS201N-08-040-ZYL-HA16-S	30393788
10	11,8	16	70	30	CFS201N-10-030-ZYL-HA16-S	30393798
10	11,8	16	90	42	CFS201N-10-042-ZYL-HA16-S	30393799
12	15,8	20	80	30	CFS201N-12-030-ZYL-HA20-S	30393963
12	15,8	20	105	55	CFS201N-12-055-ZYL-HA20-S	30393964
16	19,8	25	90	40	CFS201N-16-040-ZYL-HA25-S	30393976

Ausführung aus Hartmetall

6	7,8	10	110	70	CFS201N-06-070-ZYL-HA10-H	30393779
8	9,8	16	110	60	CFS201N-08-060-ZYL-HA16-H	30393790
10	11,8	20	110	60	CFS201N-10-060-ZYL-HA20-H	30393801
10	11,8	20	150	100	CFS201N-10-100-ZYL-HA20-H	30393802
12	15,8	20	130	80	CFS201N-12-080-ZYL-HA20-H	30393966
12	15,8	20	150	100	CFS201N-12-100-ZYL-HA20-H	30393967
16	19,8	25	150	94	CFS201N-16-094-ZYL-HA25-H	30393979

Schnittwertempfehlung für Anbohrer

Vorschub und Schnittgeschwindigkeit

CPD-Spot-Drill | CPD100

MZG*	Werkstoff	Festigkeit/ Härte [N/mm ²] [HRC]	Kühlung			v _c [m/min]	f _z [mm]					
			MMS/Luft	Trocken	KSS		Bohrerdurchmesser [mm]					
							8,00	10,00	12,00	16,00	20,00	
P	P1.1	Bau-, Automaten-, Einsatz- und Vergütungsstähle, unlegiert	< 700	✓	✓	✓	160	0,084	0,100	0,115	0,141	0,161
	P1.2	Bau-, Automaten-, Einsatz- und Vergütungsstähle, unlegiert	< 1.200	✓	✓	✓	130	0,078	0,094	0,108	0,131	0,150
	P2.1	Nitrier-, Einsatz- und Vergütungsstähle, legiert	< 900	✓	✓	✓	145	0,084	0,100	0,115	0,141	0,161
	P2.2	Nitrier-, Einsatz- und Vergütungsstähle, legiert	< 1.400	✓		✓	100	0,070	0,084	0,096	0,117	0,134
	P3.1	Werkzeug-, Wälzlager-, Feder- und Schnellarbeitsstähle**	< 800	✓	✓	✓	95	0,081	0,097	0,111	0,136	0,156
	P3.2	Werkzeug-, Wälzlager-, Feder- und Schnellarbeitsstähle**	< 1.000	✓		✓	85	0,077	0,092	0,106	0,129	0,148
	P3.3	Werkzeug-, Wälzlager-, Feder- und Schnellarbeitsstähle**	< 1.500	✓		✓	80	0,073	0,087	0,100	0,122	0,140
	P4.1	Rostfreie Stähle, ferritisch und martensitisch		✓		✓	65	0,056	0,067	0,077	0,094	0,107
	P5.1	Stahlguss				✓	95	0,081	0,097	0,111	0,136	0,156
P6.1	Rostfreier Stahlguss, ferritisch und martensitisch				✓	65	0,039	0,047	0,054	0,066	0,075	
M	M1.1	Rostfreie Stähle, austenitisch	< 700	✓		✓	45	0,049	0,059	0,067	0,082	0,094
	M1.2	Rostfreie Stähle, ferritisch/austenitisch (Duplex)	< 1.000			✓	40	0,040	0,048	0,056	0,068	0,078
	M2.1	Rostfreier Stahlguss, austenitisch	< 700	✓		✓	50	0,053	0,064	0,073	0,089	0,102
	M3.1	Rostfreier Stahlguss, ferritisch/austenitisch (Duplex)	< 1.000			✓	45	0,042	0,050	0,058	0,070	0,081
K	K1.1	Gusseisen mit Lamellengraphit (Grauguss), GJL	< 300	✓	✓	✓	175	0,140	0,167	0,192	0,235	0,268
	K2.1	Gusseisen mit Kugelgraphit, GJS	< 500	✓	✓	✓	160	0,119	0,142	0,163	0,199	0,228
	K2.2	Gusseisen mit Kugelgraphit, GJS	500-800	✓	✓	✓	130	0,098	0,117	0,134	0,164	0,188
	K2.3	Gusseisen mit Kugelgraphit, GJS	> 800	✓	✓	✓	70	0,056	0,067	0,077	0,094	0,107
	K3.1	Gusseisen mit Vermiculargraphit, GJV; Temperguss, GJM	< 500	✓	✓	✓	115	0,098	0,117	0,134	0,164	0,188
	K3.2	Gusseisen mit Vermiculargraphit, GJV; Temperguss, GJM	> 500	✓	✓	✓	110	0,084	0,100	0,115	0,141	0,161
N	N1.1	Aluminium, unlegiert und legiert <3 % Si		✓	✓	✓	610	0,142	0,170	0,196	0,239	0,273
	N1.2	Aluminium, legiert ≤ 7 % Si		✓	✓	✓	405	0,149	0,179	0,206	0,251	0,287
	N1.3	Aluminium, legiert > 7-12 % Si		✓	✓	✓	325	0,156	0,187	0,215	0,263	0,301
	N1.4	Aluminium, legiert > 12 % Si		✓	✓	✓	235	0,171	0,204	0,235	0,287	0,328
	N2.1	Kupfer, unlegiert und niedriglegiert	< 300	✓	✓	✓	235	0,114	0,136	0,157	0,191	0,219
	N2.2	Kupfer, legiert	> 300	✓	✓	✓	175	0,114	0,136	0,157	0,191	0,219
	N2.3	Messing, Bronze, Rotguss	< 1.200	✓	✓	✓	295	0,071	0,085	0,098	0,120	0,137

* MAPAL Zerspanungsgruppen

** Wenn die Legierungsbestandteile Cr, Mo, Ni, V, W in Summe > 8 %, dann die nächst höhere MAPAL Zerspanungsgruppe wählen.

Die angegebenen Arbeitswerte sind Richtwerte.

Die für den jeweiligen Bearbeitungsfall optimalen Daten sollten im Versuch oder während der Bearbeitung ermittelt werden.

Schnittwertempfehlung für Anbohrer

Vorschub und Schnittgeschwindigkeit

Tritan-Spot-Drill-Steel | SCD670

MZG*	Werkstoff	Festigkeit/Härte [N/mm ²] [HRC]
P	P1.1 Bau-, Automaten-, Einsatz- und Vergütungsstähle, unlegiert	< 700
	P1.2 Bau-, Automaten-, Einsatz- und Vergütungsstähle, unlegiert	< 1.200
	P2.1 Nitrier-, Einsatz- und Vergütungsstähle, legiert	< 900
	P2.2 Nitrier-, Einsatz- und Vergütungsstähle, legiert	< 1.400
	P3.1 Werkzeug-, Wälzlager-, Feder- und Schnellarbeitsstähle**	< 800
	P3.2 Werkzeug-, Wälzlager-, Feder- und Schnellarbeitsstähle**	< 1.000
	P3.3 Werkzeug-, Wälzlager-, Feder- und Schnellarbeitsstähle**	< 1.500
	P5.1 Stahlguss	
M	M1.1 Rostfreie Stähle, austenitisch	< 700
	M1.2 Rostfreie Stähle, ferritisch/austenitisch (Duplex)	< 1.000
	M2.1 Rostfreier Stahlguss, austenitisch	< 700
	M3.1 Rostfreier Stahlguss, ferritisch/austenitisch (Duplex)	< 1.000
K	K1.1 Gusseisen mit Lamellengraphit (Grauguss), GJL	< 300
	K2.1 Gusseisen mit Kugelgraphit, GJS	< 500
	K2.2 Gusseisen mit Kugelgraphit, GJS	≤ 800
	K2.3 Gusseisen mit Kugelgraphit, GJS	> 800
	K3.1 Gusseisen mit Vermiculargraphit, GJV; Temperguss, GJM	< 500
	K3.2 Gusseisen mit Vermiculargraphit, GJV; Temperguss, GJM	> 500
N	N1.1 Aluminium, unlegiert und legiert < 3 % Si	
	N1.2 Aluminium, legiert ≤ 7 % Si	
	N1.3 Aluminium, legiert > 7-12 % Si	
	N1.4 Aluminium, legiert > 12 % Si	
	N2.1 Kupfer, unlegiert und niedriglegiert	< 300
	N2.2 Kupfer, legiert	> 300
	N2.3 Messing, Bronze, Rotguss	< 1.200
	N4.1 Kunststoff, Thermoplaste	
	N4.2 Kunststoff, Duroplaste	
	N4.3 Kunststoff, Schaumstoffe	
S	S1.1 Titan, Titanlegierungen	< 400
	S2.1 Titan, Titanlegierungen	< 1.200
	S2.2 Titan, Titanlegierungen	> 1.200
	S3.1 Nickel, unlegiert und legiert	< 900
	S3.2 Nickel, unlegiert und legiert	> 900
	S4.1 Hochwarmfeste Superlegierung, Ni-, Co-, und Fe-basiert	
	S5.1 Wolfram- und Molybdänlegierungen	
H	H1.1 Gehärteter Stahl/Stahlguss	< 44
	H1.2 Gehärteter Stahl/Stahlguss	< 55

* MAPAL Zerspanungsgruppen

** Wenn die Legierungsbestandteile Cr, Mo, Ni, V, W in Summe > 8 %, dann die nächst höhere MAPAL Zerspanungsgruppe wählen.

	Schnittgeschwindigkeit v_c [m/min]				Vorschub f [mm] bei Bohrerdurchmesser					
	Innenkühlung	Außenkühlung	MMS	Luft	4,00	5,50	7,50	10,50	14,50	20,00
	175	160	160		0,09	0,10	0,11	0,13	0,14	0,15
	160	130	130		0,11	0,12	0,14	0,16	0,17	0,18
	170	145	145		0,10	0,12	0,13	0,15	0,16	0,17
	120	100	100		0,08	0,09	0,11	0,12	0,13	0,14
	110	95	95		0,09	0,11	0,12	0,13	0,15	0,16
	90	85	85		0,08	0,09	0,10	0,11	0,12	0,13
	90	70	75		0,06	0,07	0,08	0,08	0,09	0,10
	110	95	95		0,10	0,12	0,13	0,15	0,16	0,17
	70	45	45		0,06	0,07	0,08	0,09	0,10	0,10
	75	50	50		0,06	0,07	0,08	0,09	0,10	0,10
	245	175	175	175	0,17	0,19	0,22	0,25	0,27	0,30
	225	140	170	170	0,16	0,18	0,20	0,23	0,25	0,27
	170	130	130		0,14	0,15	0,18	0,20	0,22	0,23
	100	70	85		0,09	0,10	0,12	0,13	0,14	0,15
	155	135	135		0,15	0,17	0,19	0,21	0,23	0,25
	135	120	120		0,12	0,13	0,15	0,17	0,19	0,20
	300	200	250		0,11	0,12	0,13	0,15	0,17	0,18
	250	180	200		0,14	0,15	0,18	0,20	0,22	0,23
	220	150	180		0,14	0,15	0,18	0,20	0,22	0,23
	180	120	150		0,14	0,15	0,18	0,20	0,22	0,23
	140	100			0,11	0,12	0,13	0,15	0,17	0,18
	120	90			0,14	0,15	0,18	0,20	0,22	0,23
	200	160	160	120	0,17	0,19	0,22	0,25	0,27	0,30
		60		50	0,09	0,10	0,12	0,13	0,14	0,15
		65		40	0,07	0,08	0,09	0,11	0,12	0,12
			400	0,07	0,08	0,09	0,11	0,12	0,12	
	40	25			0,062	0,069	0,078	0,088	0,097	0,104
	30	20			0,053	0,059	0,067	0,075	0,083	0,089
	25	15			0,044	0,050	0,056	0,063	0,069	0,074
	20	15			0,035	0,040	0,045	0,050	0,055	0,059
	15	10			0,044	0,050	0,056	0,063	0,069	0,074
	15	10			0,035	0,040	0,045	0,050	0,055	0,059
	15	10			0,035	0,040	0,045	0,050	0,055	0,059
	80	80	80		0,078	0,087	0,098	0,109	0,120	0,128
	30	30	30		0,053	0,059	0,067	0,075	0,083	0,089

Die angegebenen Schnittwerte sind Richtwerte.

Die für den jeweiligen Bearbeitungsfall optimalen Daten sollten im Versuch oder während der Bearbeitung ermittelt werden.

Schnittwertempfehlung für Anbohrer

Vorschub und Schnittgeschwindigkeit

ECU-Centre-Drill | SCD450

MZG*	Werkstoff	Festigkeit/Härte [N/mm ²] [HRC]
P	P1.1 Bau-, Automaten-, Einsatz- und Vergütungsstähle, unlegiert	< 700
	P1.2 Bau-, Automaten-, Einsatz- und Vergütungsstähle, unlegiert	< 1.200
	P2.1 Nitrier-, Einsatz- und Vergütungsstähle, legiert	< 900
	P2.2 Nitrier-, Einsatz- und Vergütungsstähle, legiert	< 1.400
	P3.1 Werkzeug-, Wälzlager-, Feder- und Schnellarbeitsstähle**	< 800
	P3.2 Werkzeug-, Wälzlager-, Feder- und Schnellarbeitsstähle**	< 1.000
	P3.3 Werkzeug-, Wälzlager-, Feder- und Schnellarbeitsstähle**	< 1.500
	P4.1 Rostfreie Stähle, ferritisch und martensitisch	
	P5.1 Stahlguss	
	P6.1 Rostfreier Stahlguss, ferritisch und martensitisch	
M	M1.1 Rostfreie Stähle, austenitisch	< 700
	M1.2 Rostfreie Stähle, ferritisch/austenitisch (Duplex)	< 1.000
	M2.1 Rostfreier Stahlguss, austenitisch	< 700
	M3.1 Rostfreier Stahlguss, ferritisch/austenitisch (Duplex)	< 1.000
N	N2.1 Kupfer, unlegiert und niedriglegiert	< 300
	N2.2 Kupfer, legiert	> 300
	N2.3 Messing, Bronze, Rotguss	< 1.200
S	S1.1 Titan, Titanlegierungen	< 400
	S2.1 Titan, Titanlegierungen	< 1.200
	S2.2 Titan, Titanlegierungen	> 1.200
	S3.1 Nickel, unlegiert und legiert	< 900
	S3.2 Nickel, unlegiert und legiert	> 900
	S4.1 Hochwarmfeste Superlegierung, Ni-, Co-, und Fe-basiert	
S5.1 Wolfram- und Molybdänlegierungen		

* MAPAL Zerspanungsgruppen

** Wenn die Legierungsbestandteile Cr, Mo, Ni, V, W in Summe > 8 %, dann die nächst höhere MAPAL Zerspanungsgruppe wählen.

	Schnittgeschwindigkeit v_c [m/min]				Vorschub f [mm] bei Bohrerdurchmesser					
	Innenkühlung	Außenkühlung	MMS	Luft	0,50	0,83	1,38	2,29	3,80	6,30
		70	70		0,01	0,01	0,02	0,02	0,03	0,04
		55	55		0,01	0,02	0,02	0,03	0,04	0,06
		65	65		0,01	0,01	0,02	0,03	0,04	0,05
		45	45		0,01	0,01	0,02	0,02	0,03	0,04
		50	50		0,01	0,01	0,02	0,02	0,03	0,05
		40	40		0,01	0,01	0,02	0,02	0,03	0,04
		35	40		0,01	0,01	0,01	0,02	0,02	0,03
		35	40		0,01	0,01	0,01	0,02	0,02	0,03
		65	65		0,01	0,01	0,02	0,03	0,04	0,05
		35	40		0,01	0,01	0,01	0,02	0,02	0,03
		30	30		0,01	0,01	0,01	0,02	0,02	0,03
		25	25		0,01	0,01	0,01	0,01	0,02	0,03
		30	30		0,01	0,01	0,01	0,02	0,02	0,03
		25	25		0,01	0,01	0,01	0,01	0,02	0,03
		85			0,01	0,01	0,02	0,02	0,03	0,04
		75			0,01	0,01	0,02	0,03	0,04	0,06
		135	135		0,01	0,01	0,02	0,03	0,04	0,07
		40	40		0,01	0,01	0,02	0,02	0,03	0,04
		35	35		0,01	0,01	0,02	0,02	0,03	0,04
		30	30		0,01	0,01	0,02	0,02	0,03	0,04
		25	25		0,01	0,01	0,02	0,02	0,03	0,04
		20	20		0,01	0,01	0,02	0,02	0,03	0,04
		20	20		0,01	0,01	0,02	0,02	0,03	0,04
		20	20		0,01	0,01	0,02	0,02	0,03	0,04

Die angegebenen Schnittwerte sind Richtwerte.

Die für den jeweiligen Bearbeitungsfall optimalen Daten sollten im Versuch oder während der Bearbeitung ermittelt werden.



STUFENBOHREN

Stufenbohrer

Tritan-Step-Drill-Steel 258

MEGA-Step-Drill-Steel-Plus 259

Technischer Anhang

Schnittwertempfehlung 262

Tritan-Step-Drill-Steel

Vollhartmetall-Stufenbohrer
SCD561, innere Kühlmittelzufuhr

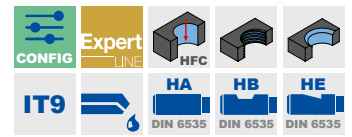
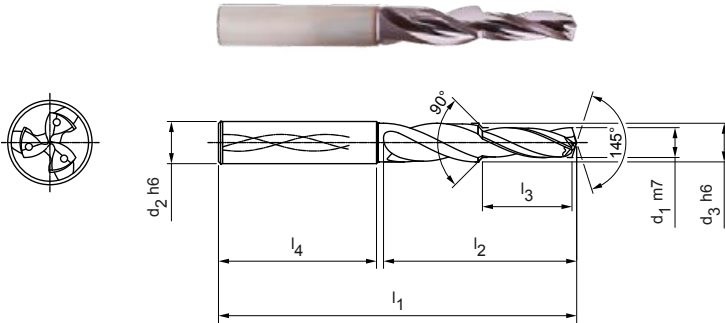

Ausführung:
Bohrerdurchmesser: 3,98 – 17,50 mm
Bohrungstoleranz: IT 9 (erreichbar)
Schneidstoff: HP835
Schneidenanzahl: 3
Anzahl Führungsfasen: 3
Spitzenwinkel: 145°
Spiralwinkel: 30°

Anwendung:
Für Gewinde-Kernlochbohrung mit Ansenkung 90°.

Lagerhaltige Vorzugsbaureihe in Schaftform HA

Baumaße								Schaftform HA	
Für Gewinde	d ₁ m7	d ₂ h6	d ₃ h6	l ₁	l ₂	l ₃	l ₄	Spezifikation	Bestell-Nr.
M5	4,25	6	5,5	66	28	13,6	36	SCD561-0425-3-3-145HA-HP835	31053657
M6	5,10	8	6,6	79	41	16,5	36	SCD561-0510-3-3-145HA-HP835	31053658
M8	6,85	10	8,8	89	47	21	40	SCD561-0685-3-3-145HA-HP835	31053659
M8x1	7,10	10	8,8	89	47	21	40	SCD561-0710-3-3-145HA-HP835	31073436
M10	8,60	12	11	102	55	25,5	45	SCD561-0860-3-3-145HA-HP835	31053670
M10x1	9,10	12	11	102	55	25,5	45	SCD561-0910-3-3-145HA-HP835	31073438
M12	10,35	14	13,2	107	60	30	45	SCD561-1035-3-3-145HA-HP835	31053671
M16	14,15	18	17,6	123	73	38,5	48	SCD561-1415-3-3-145HA-HP835	31053672

Konfigurierbare Merkmale

Durchmesser:
Durchmesser in Abstufungen von 0,01 mm frei wählbar

Stufenlänge:
Stufenlänge in Abstufungen von 0,01 mm frei wählbar

Schaftform:
Schaftform: HB | HE

Spezifikation:
SCD561-[Durchmesser]-3-3-145[Schaftform]-HP835

Beispiel:
SCD561-0431-3-3-145HE-HP835

Schaftform HE

Werkzeugdurchmesser d₁ = 4,31 mm

Maßangaben in mm.
Schnittwertempfehlung siehe Kapitelende.
Sonderausführungen und andere Beschichtungen auf Anfrage.

Abmessungen konfigurierbare Baureihe

d ₁ min.	d ₁ max.	d ₂ h6	d ₃ h6	l ₁	l ₂	l ₃ min.	l ₃ max.
3,98	4,50	6	5	66	28	4,00	15,4
4,51	5,50	6	6	66	28	4,50	15,4
5,51	6,50	8	7	79	41	5,50	22,55
6,51	7,50	8	8	79	41	6,50	22,55
7,51	8,50	10	9	89	47	7,50	25,85
8,51	9,50	10	10	89	47	8,50	25,85
9,51	11,50	12	12	102	55	9,50	30,25
11,51	13,50	14	14	107	60	11,50	33
13,51	15,50	16	16	115	65	13,50	35,75
15,51	17,50	18	18	123	73	15,50	40,15

Kernlochbohrungen mit 90°-Fase

nach DIN 8378 mit dem Tritan-Step-Drill-Steel



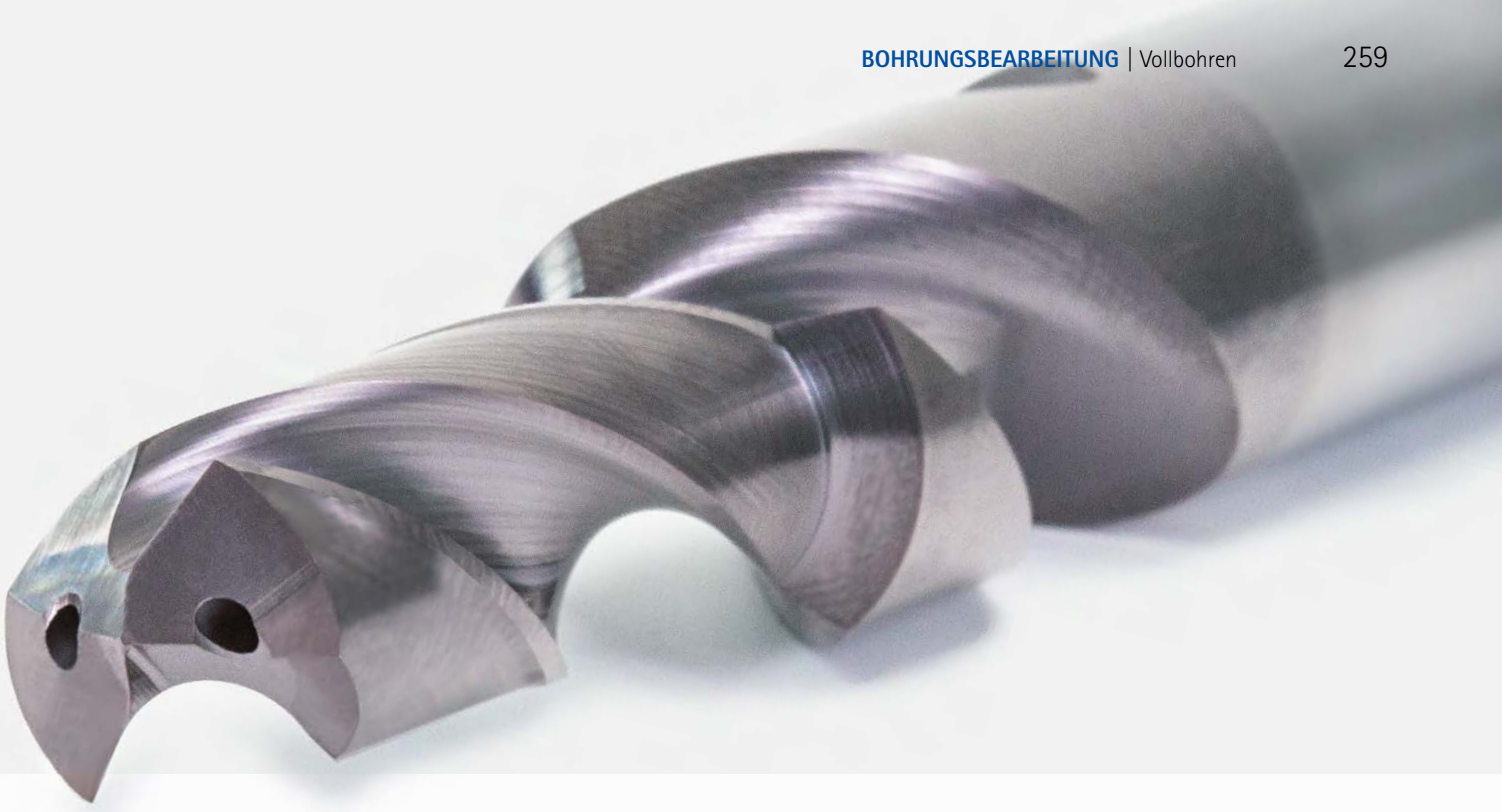

MEGA-STEP-DRILL-STEEL-PLUS

Wirtschaftliche Bearbeitung von Gewindekernlöchern (nach DIN 8378)

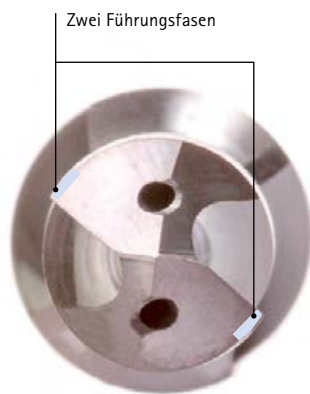

Kernlochbohrung M10

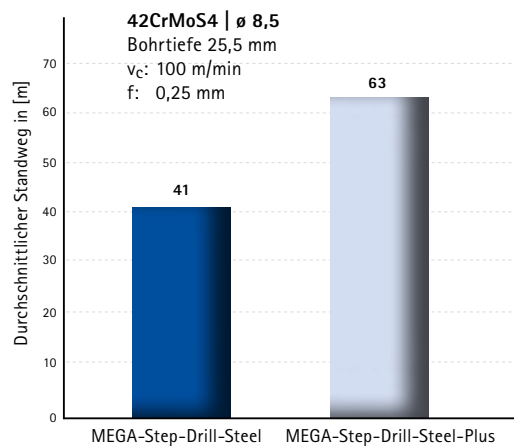
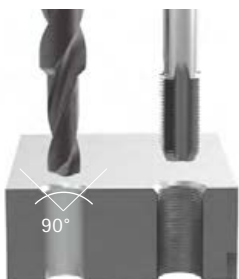

AUF EINEN BLICK

- Upgrade des MEGA-Step-Drill-Steel mit und ohne IK
- Innovative Beschichtung
- Optimierte Mikro- und Makrogeometrie
- Durchmesserbereich von 2,50 bis 15,00 mm

VORTEILE

- 15 Prozent höhere Schnittgeschwindigkeit*
- 15 Prozent höherer Vorschub*
- 50 Prozent höhere Standzeit*

* Im Vergleich zum Vorgängermodell

MEGA-Step-Drill-Steel-Plus

Vollhartmetall-Stufenbohrer

SCD590, äußere Kühlmittelzufuhr, Nachfolgeprodukt des MEGA-Step-Drill-Steel

Ausführung:

Bohrerdurchmesser: 2,50 – 14,00 mm
 Schneidstoff: HP358
 Schneidanzahl: 2
 Anzahl Führungsfasen: 2
 Spitzenwinkel: 140°
 Spiralwinkel: 30°

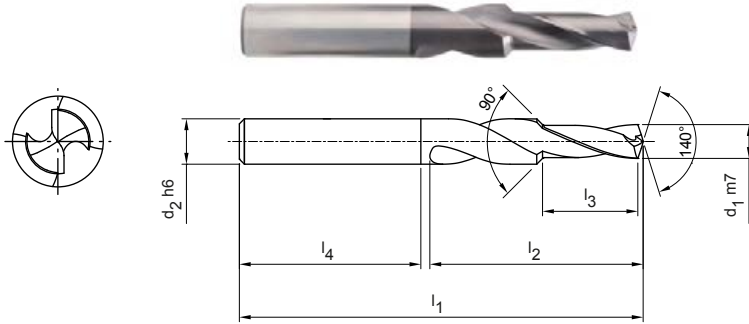

Lagerhaltige Vorzugsbaureihe in Schaftform HA

		Baumaße						Schaftform HA	
Für Gewinde	Art	d ₁ m7	d ₂ h6	l ₁	l ₂	l ₃	l ₄	Spezifikation	Bestell-Nr.
M3	GB	2,50	6	62	20	8,8	36	SCD590-0250-2-2-140HA-HP358	31228957
M3	FO	2,80	6	62	20	8,8	36	SCD590-0280-2-2-140HA-HP358	31228958
M4	GB	3,30	6	62	24	11,4	36	SCD590-0330-2-2-140HA-HP358	31228959
M4	FO	3,70	6	62	24	11,4	36	SCD590-0370-2-2-140HA-HP358	31228960
M5	GB	4,20	6	66	28	13,6	36	SCD590-0420-2-2-140HA-HP358	31228961
M5	FO	4,65	6	66	28	13,6	36	SCD590-0465-2-2-140HA-HP358	31228962
M6	GB	5,00	8	79	34	16,5	36	SCD590-0500-2-2-140HA-HP358	31149619
M6	FO	5,55	8	79	34	16,5	36	SCD590-0555-2-2-140HA-HP358	31228963
M8	GB	6,80	10	89	47	21	40	SCD590-0680-2-2-140HA-HP358	31141315
M8	FO	7,45	10	89	47	21	40	SCD590-0745-2-2-140HA-HP358	31228964
M10	GB	8,50	12	102	55	25,5	45	SCD590-0850-2-2-140HA-HP358	31228965
M10	FO	9,30	12	102	55	25,5	45	SCD590-0930-2-2-140HA-HP358	31228966
M12	GB	10,20	14	107	60	30	45	SCD590-1020-2-2-140HA-HP358	31228967
M12	FO	11,20	14	107	60	30	45	SCD590-1120-2-2-140HA-HP358	31228968
M14	GB	12,00	16	115	65	34,5	48	SCD590-1200-2-2-140HA-HP358	31149650
M16	GB	14,00	18	123	73	38,5	48	SCD590-1400-2-2-140HA-HP358	31228970

GB: Kernloch Gewindebohren | FO: Kernloch Gewindeformen / Gewindefurchen

Konfigurierbare Merkmale



Schaftform:
Schaftform: HB | HE



Spezifikation:
SCD590-0420-2-2-140[**Schaftform**]-HP358

Beispiel:

SCD590-0420-2-2-140**HE**05-HP358

Schaftform HE

Maßangaben in mm.

Schnittwertempfehlung siehe Kapitelende.

Sonderausführungen und andere Beschichtungen auf Anfrage.

MEGA-Step-Drill-Steel-Plus

Vollhartmetall-Stufenbohrer

SCD591, innere Kühlmittelzufuhr, Nachfolgeprodukt des MEGA-Step-Drill-Steel

Ausführung:

Bohrerdurchmesser: 3,30 - 14,00 mm

Schneidstoff: HP358

Schneidenanzahl: 2

Anzahl Führungsfasen: 2

Spitzenwinkel: 140°

Spiralwinkel: 30°

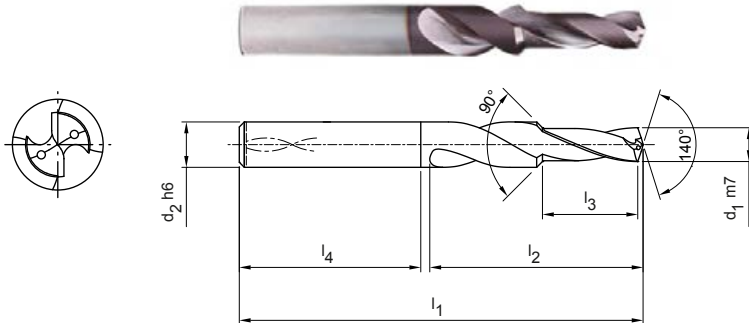

Lagerhaltige Vorzugsbaureihe in Schaftform HA

		Baumaße						Schaftform HA	
Für Gewinde	Art	d ₁ m7	d ₂ h6	l ₁	l ₂	l ₃	l ₄	Spezifikation	Bestell-Nr.
M4	GB	3,30	6	62	24	11,4	36	SCD591-0330-2-2-140HA-HP358	31140987
M4	F0	3,70	6	62	24	11,4	36	SCD591-0370-2-2-140HA-HP358	31140988
M5	GB	4,20	6	66	28	13,6	36	SCD591-0420-2-2-140HA-HP358	31140989
M6	GB	5,00	8	79	34	16,5	36	SCD591-0500-2-2-140HA-HP358	31140991
M6	F0	5,55	8	79	34	16,5	36	SCD591-0555-2-2-140HA-HP358	31140992
M8	GB	6,80	10	89	47	21	40	SCD591-0680-2-2-140HA-HP358	31140993
M8	F0	7,45	10	89	47	21	40	SCD591-0745-2-2-140HA-HP358	31140994
M10	GB	8,50	12	102	55	25,5	45	SCD591-0850-2-2-140HA-HP358	31140995
M10	F0	9,30	12	102	55	25,5	45	SCD591-0930-2-2-140HA-HP358	31140996
M12	GB	10,20	14	107	60	30	45	SCD591-1020-2-2-140HA-HP358	31140997
M12	GB	10,20	14	107	60	30	45	SCD591-1020-2-2-140HA-HP358	31140997

Auf Anfrage erhältlich

M12	F0	11,20	14	107	60	30	45	SCD591-1120-2-2-140HA-HP358	31140998
M16	GB	14,00	18	123	73	38,5	48	SCD591-1400-2-2-140HA-HP358	31140999

GB: Kernloch Gewindebohren | F0: Kernloch Gewindeformen / Gewindefurchen

Konfigurierbare Merkmale



Schaftform:
Schaftform: HB | HE



Spezifikation:
SCD591-0420-2-2-140[**Schaftform**]-HP358

Beispiel:

SCD591-0420-2-2-140**HE**05-HP358

Schaftform HE

Maßangaben in mm.

Schnittwertempfehlung siehe Kapitelende.

Sonderausführungen und andere Beschichtungen auf Anfrage.

Schnittwertempfehlung für Stufenbohrer

Vorschub und Schnittgeschwindigkeit

Tritan-Step-Drill-Steel | SCD561

MZG*	Werkstoff	Festigkeit/Härte [N/mm ²] [HRC]
P	P1.1 Bau-, Automaten-, Einsatz- und Vergütungsstähle, unlegiert	< 700
	P1.2 Bau-, Automaten-, Einsatz- und Vergütungsstähle, unlegiert	< 1.200
	P2.1 Nitrier-, Einsatz- und Vergütungsstähle, legiert	< 900
	P2.2 Nitrier-, Einsatz- und Vergütungsstähle, legiert	< 1.400
	P3.1 Werkzeug-, Wälzlager-, Feder- und Schnellarbeitsstähle**	< 800
	P3.2 Werkzeug-, Wälzlager-, Feder- und Schnellarbeitsstähle**	< 1.000
	P3.3 Werkzeug-, Wälzlager-, Feder- und Schnellarbeitsstähle**	< 1.500
	P5.1 Stahlguss	
M	M1.1 Rostfreie Stähle, austenitisch	< 700
	M1.2 Rostfreie Stähle, ferritisch/austenitisch (Duplex)	< 1.000
K	K1.1 Gusseisen mit Lamellengraphit (Grauguss), GJL	< 300
	K2.1 Gusseisen mit Kugelgraphit, GJS	< 500
	K2.2 Gusseisen mit Kugelgraphit, GJS	≤ 800
	K2.3 Gusseisen mit Kugelgraphit, GJS	> 800
	K3.1 Gusseisen mit Vermiculargraphit, GJV; Temperguss, GJM	< 500
	K3.2 Gusseisen mit Vermiculargraphit, GJV; Temperguss, GJM	> 500

* MAPAL Zerspanungsgruppen

** Wenn die Legierungsbestandteile Cr, Mo, Ni, V, W in Summe > 8 %, dann die nächst höhere MAPAL Zerspanungsgruppe wählen.

	Schnittgeschwindigkeit v_c [m/min]				Vorschub f [mm] bei Bohrerdurchmesser					
	Innenkühlung	Außenkühlung	MMS	Luft	4,00	5,50	7,50	10,50	14,50	20,00
	115	105	105		0,24	0,30	0,37	0,46	0,56	0,65
	105	85	85		0,30	0,37	0,46	0,58	0,70	0,81
	115	100	100		0,28	0,35	0,44	0,55	0,66	0,77
	80	70	70		0,24	0,29	0,36	0,44	0,53	0,61
	85	75	75		0,25	0,31	0,39	0,49	0,60	0,69
	70	65	65		0,21	0,26	0,33	0,41	0,49	0,56
	70	50	60		0,18	0,21	0,26	0,32	0,38	0,43
	115	100	100		0,28	0,35	0,44	0,55	0,66	0,77
	55	35	35		0,11	0,14	0,18	0,22	0,27	0,31
	140	100	100	100	0,36	0,45	0,55	0,67	0,80	0,91
	185	115	140	140	0,35	0,43	0,52	0,63	0,74	0,84
	115	85	85		0,31	0,38	0,46	0,55	0,64	0,73
	70	45	60		0,17	0,20	0,24	0,28	0,33	0,37
	105	90	90		0,34	0,41	0,49	0,59	0,69	0,78
	90	80	80		0,28	0,34	0,40	0,47	0,55	0,62

Die angegebenen Schnittwerte sind Richtwerte.

Die für den jeweiligen Bearbeitungsfall optimalen Daten sollten im Versuch oder während der Bearbeitung ermittelt werden.

Schnittwertempfehlung für Stufenbohrer

Vorschub und Schnittgeschwindigkeit

MEGA-Step-Drill-Steel-Plus | SCD590, 591

MZG*	Werkstoff	Festigkeit/Härte [N/mm ²] [HRC]	
P	P1.1 Bau-, Automaten-, Einsatz- und Vergütungsstähle, unlegiert	< 700	
	P1.2 Bau-, Automaten-, Einsatz- und Vergütungsstähle, unlegiert	< 1.200	
	P2.1 Nitrier-, Einsatz- und Vergütungsstähle, legiert	< 900	
	P2.2 Nitrier-, Einsatz- und Vergütungsstähle, legiert	< 1.400	
	P3.1 Werkzeug-, Wälzlager-, Feder- und Schnellarbeitsstähle**	< 800	
	P3.2 Werkzeug-, Wälzlager-, Feder- und Schnellarbeitsstähle**	< 1.000	
	P3.3 Werkzeug-, Wälzlager-, Feder- und Schnellarbeitsstähle**	< 1.500	
	P4.1 Rostfreie Stähle, ferritisch und martensitisch		
	P5.1 Stahlguss		
	P6.1 Rostfreier Stahlguss, ferritisch und martensitisch		
	K	K1.1 Gusseisen mit Lamellengraphit (Grauguss), GJL	< 300
		K2.1 Gusseisen mit Kugelgraphit, GJS	< 500
K2.2 Gusseisen mit Kugelgraphit, GJS		≤ 800	
K2.3 Gusseisen mit Kugelgraphit, GJS		> 800	
K3.1 Gusseisen mit Vermiculargraphit, GJV; Temperguss, GJM		< 500	
K3.2 Gusseisen mit Vermiculargraphit, GJV; Temperguss, GJM		> 500	
H	H1.1 Gehärteter Stahl/Stahlguss	< 44	
	H1.2 Gehärteter Stahl/Stahlguss	< 55	

* MAPAL Zerspanungsgruppen

** Wenn die Legierungsbestandteile Cr, Mo, Ni, V, W in Summe > 8 %, dann die nächst höhere MAPAL Zerspanungsgruppe wählen.

	Schnittgeschwindigkeit v_c [m/min]				Vorschub f [mm] bei Bohrerdurchmesser					
	Innenkühlung	Außenkühlung	MMS	Luft	2,50	3,70	5,00	7,45	10,20	15,00
	110	100	100		0,09	0,11	0,14	0,18	0,23	0,29
	100	85	85		0,11	0,14	0,18	0,23	0,29	0,36
	110	95	95		0,10	0,13	0,17	0,22	0,27	0,34
	75	65	65		0,09	0,11	0,14	0,18	0,22	0,27
	85	70	70		0,09	0,11	0,15	0,19	0,25	0,30
	65	60	60		0,08	0,10	0,13	0,16	0,20	0,25
	65	50	55		0,07	0,08	0,10	0,13	0,16	0,19
	65	50	55		0,06	0,08	0,10	0,13	0,16	0,20
	110	95	95		0,10	0,13	0,17	0,22	0,27	0,34
	65	50	55		0,06	0,08	0,10	0,13	0,16	0,20
	120	85	85	85	0,13	0,19	0,26	0,35	0,45	0,54
	160	100	120	120	0,13	0,18	0,25	0,33	0,42	0,50
	100	75	75		0,12	0,16	0,22	0,28	0,36	0,43
	60	40	50		0,09	0,12	0,15	0,19	0,24	0,28
	90	80	80		0,13	0,18	0,23	0,31	0,39	0,46
	80	70	70		0,11	0,15	0,19	0,25	0,31	0,36
	90	90	90		0,08	0,10	0,13	0,16	0,20	0,25
	25	25	25		0,04	0,05	0,07	0,09	0,11	0,14

Die angegebenen Schnittwerte sind Richtwerte.

Die für den jeweiligen Bearbeitungsfall optimalen Daten sollten im Versuch oder während der Bearbeitung ermittelt werden.





TIEFBOHREN

Tiefbohrer

MEGA-Pilot-Drill	268
MEGA-Deep-Drill	269
MEGA-Deep-Drill-Alu	278

Technischer Anhang

Schnittwertempfehlung	284
Anwendungshinweise Tiefbohrer	742

MEGA-Pilot-Drill

Vollhartmetall-Stufenbohrer
SCD581, innere Kühlmittelzufuhr

Ausführung:
Bohrerdurchmesser: 1,00 – 3,00 mm
Bohrungstoleranz: IT 9 (erreichbar)
Schneidstoff: HP246
Schneidenanzahl: 2
Anzahl Führungsfasen: 2
Spitzenwinkel: 142°

Anwendung:
Speziell auf den MEGA-Deep-Drill abgestimmter Pilotbohrer.
Maximal einsetzbar bis Durchmesser 3,00 mm.

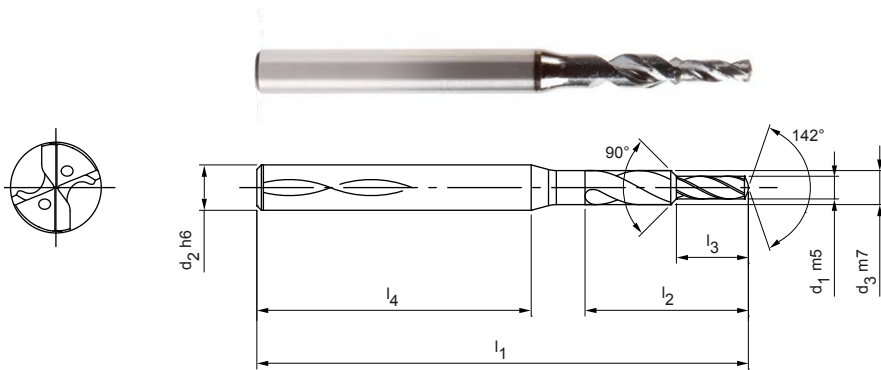

Lagerhaltige Vorzugsbaureihe in Schaftform HA

Baumaße							Schaftform HA	
d_1 m5	d_2 h6	d_3 m7	l_1	l_2	l_3	l_4	Spezifikation	Bestell-Nr.
1,00	3	1,5	50	7,2	3	38	SCD581-0100-2-2-142HA-HP246	31080870
1,10	3	1,65	50	7,9	3,3	37,5	SCD581-0110-2-2-142HA-HP246	31080871
1,20	3	1,8	50	8,6	3,6	36,9	SCD581-0120-2-2-142HA-HP246	31080872
1,30	3	1,95	50	9,4	3,9	36,3	SCD581-0130-2-2-142HA-HP246	31080873
1,40	3	2,1	50	10,1	4,2	35,7	SCD581-0140-2-2-142HA-HP246	31080874
1,50	3	2,25	50	10,8	4,5	35,1	SCD581-0150-2-2-142HA-HP246	31080875
1,60	3	2,4	50	11,5	4,8	34,6	SCD581-0160-2-2-142HA-HP246	31080876
1,70	3	2,55	50	12,2	5,1	34	SCD581-0170-2-2-142HA-HP246	31080877
1,80	3	2,7	50	13	5,4	33,4	SCD581-0180-2-2-142HA-HP246	31080878
1,90	4	2,85	55	13,7	5,7	35,9	SCD581-0190-2-2-142HA-HP246	31080879
2,00	4	3	55	14,4	6	35,3	SCD581-0200-2-2-142HA-HP246	31080880
2,10	4	3,15	55	15,1	6,3	34,8	SCD581-0210-2-2-142HA-HP246	31080881
2,20	4	3,3	55	15,8	6,6	34,2	SCD581-0220-2-2-142HA-HP246	31080882
2,30	4	3,45	55	16,6	6,9	33,6	SCD581-0230-2-2-142HA-HP246	31080883
2,40	4	3,6	55	17,3	7,2	33	SCD581-0240-2-2-142HA-HP246	31080884
2,50	4	3,75	55	18	7,5	32,4	SCD581-0250-2-2-142HA-HP246	31080885
2,60	6	3,9	66	18,7	7,8	39,1	SCD581-0260-2-2-142HA-HP246	31080886
2,70	6	4,05	66	19,4	8,1	38,5	SCD581-0270-2-2-142HA-HP246	31080887
2,80	6	4,2	66	20,2	8,4	37,9	SCD581-0280-2-2-142HA-HP246	31080888
2,90	6	4,35	66	20,9	8,7	37,4	SCD581-0290-2-2-142HA-HP246	31080889
3,00	6	4,5	66	21,6	9	36,8	SCD581-0300-2-2-142HA-HP246	31080890

Maßangaben in mm.
Schnittwertempfehlung siehe Kapitelende.
Sonderausführungen und andere Beschichtungen auf Anfrage.

MEGA-Deep-Drill

Vollhartmetall-Spiralbohrer
SCD171 (20xD), innere Kühlmittelzufuhr

Ausführung:

Bohrerdurchmesser: 1,00 – 2,99 mm
Bohrungstoleranz: \geq IT 9
Schneidstoff: HP246
Schneidenanzahl: 2
Anzahl Führungsfasen: 4
Spitzenwinkel: 135°
Spiralwinkel: 30°
Besonderheiten: Kopfbeschichtung

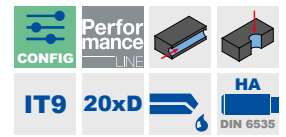
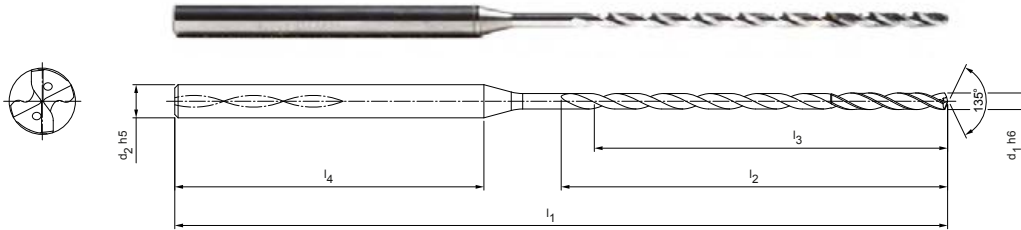

Lagerhaltige Vorzugsbaureihe in Schaftform HA

Baumaße						L/d- Verhältnis	Schaftform HA	
d ₁ h6	d ₂ h5	l ₁	l ₂	l ₃	l ₄		Spezifikation	Bestell-Nr.
1,00	3	62	27	25	28	28	SCD171-0100-2-4-135HA20-HP246	30998795
1,10	3	62	27	25	28	28	SCD171-0110-2-4-135HA20-HP246	30998796
1,20	3	62	27	25	28	28	SCD171-0120-2-4-135HA20-HP246	30998798
1,30	3	70	35	33	28	28	SCD171-0130-2-4-135HA20-HP246	30998799
1,40	3	70	35	32	28	28	SCD171-0140-2-4-135HA20-HP246	30998800
1,50	3	70	35	32	28	28	SCD171-0150-2-4-135HA20-HP246	30998801
1,60	3	75	41	38	28	28	SCD171-0160-2-4-135HA20-HP246	30998802
1,70	3	75	41	38	28	28	SCD171-0170-2-4-135HA20-HP246	30998803
1,80	3	75	41	38	28	28	SCD171-0180-2-4-135HA20-HP246	30998804
1,90	3	80	46	43	28	28	SCD171-0190-2-4-135HA20-HP246	30998805
2,00	3	80	46	43	28	28	SCD171-0200-2-4-135HA20-HP246	30998806
2,10	3	80	46	42	28	28	SCD171-0210-2-4-135HA20-HP246	30998807
2,20	3	90	55	51	28	28	SCD171-0220-2-4-135HA20-HP246	30998808
2,30	3	90	55	51	28	28	SCD171-0230-2-4-135HA20-HP246	30998809
2,40	3	90	55	51	28	28	SCD171-0240-2-4-135HA20-HP246	30998810
2,50	3	90	55	51	28	28	SCD171-0250-2-4-135HA20-HP246	30998811
2,60	3	100	66	62	28	28	SCD171-0260-2-4-135HA20-HP246	30998812
2,70	3	100	66	61	28	28	SCD171-0270-2-4-135HA20-HP246	30998813
2,80	3	100	66	61	28	28	SCD171-0280-2-4-135HA20-HP246	30998814
2,90	3	100	66	61	28	28	SCD171-0290-2-4-135HA20-HP246	30998815

Fortsetzung auf nächster Seite.

Empfehlung für Pilotbohrer:

Bitte verwenden Sie als Pilotbohrer den MEGA-Pilot-Drill (SCD581) oder den MICRO-Drill-Steel (SCD371 - 5xD) mit dem gleichen Nenndurchmesser. Spitzenwinkel und Durchmesser-toleranzen sind für eine optimale Funktionalität sowie auf das Zusammenspiel von Pilotbohrer und Tiefbohrer abgestimmt.

MEGA-Deep-Drill | Vollhartmetall-Spiralbohrer SCD171 (20xD), innere Kühlmittelzufuhr

Konfigurierbare Merkmale



Durchmesser:
Durchmesser in Abstufungen
von 0,01 mm frei wählbar

**Spezifikation:**

SCD171-[Durchmesser]-2-4-135HA20-HP246

Beispiel:

SCD171-0221-2-4-135HA20-HP246

Werkzeugdurchmesser $d_1 = 2,21$ mm

Abmessungen konfigurierbare Baureihe

d_1 min.	d_1 max.	d_2 h6	l_1	l_2	l_3	l_4
1,00	1,29	3	62	27	25	28
1,30	1,39	3	70	35	33	28
1,40	1,59	3	70	35	32	28
1,60	1,89	3	75	41	38	28
1,90	2,09	3	80	46	43	28
2,10	2,19	3	80	46	42	28
2,20	2,59	3	90	55	51	28
2,60	2,69	3	100	66	62	28
2,70	2,99	3	100	66	61	28

Anwendungstechnische Hinweise zum Tiefbohren
finden Sie im Kapitel Technischer Anhang.

Maßangaben in mm.

Schnittwertempfehlung siehe Kapitelende.

Sonderausführungen und andere Beschichtungen auf Anfrage.

MEGA-Deep-Drill

Vollhartmetall-Spiralbohrer
SCD171 (30xD), innere Kühlmittelzufuhr

Ausführung:

Bohrerdurchmesser: 1,00 – 2,99 mm
Bohrungstoleranz: \geq IT 9
Schneidstoff: HP246
Schneidenanzahl: 2
Anzahl Führungsfasen: 4
Spitzenwinkel: 135°
Spiralwinkel: 30°
Besonderheiten: Kopfbeschichtung

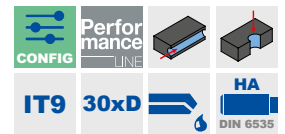
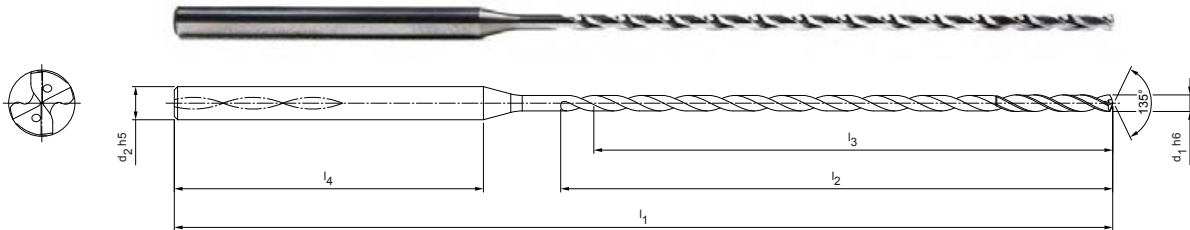

Lagerhaltige Vorzugsbaureihe in Schaftform HA

Baumaße						L/d-Verhältnis	Schaftform HA	
d ₁ h6	d ₂ h5	l ₁	l ₂	l ₃	l ₄		Spezifikation	Bestell-Nr.
1,00	3	75	38	36	28	36	SCD171-0100-2-4-135HA30-HP246	30998816
1,10	3	75	38	36	28	33	SCD171-0110-2-4-135HA30-HP246	30998817
1,20	3	75	38	36	28	30	SCD171-0120-2-4-135HA30-HP246	30998818
1,30	3	85	50	48	28	37	SCD171-0130-2-4-135HA30-HP246	30998819
1,40	3	85	50	47	28	34	SCD171-0140-2-4-135HA30-HP246	30998820
1,50	3	85	50	47	28	31	SCD171-0150-2-4-135HA30-HP246	30998821
1,60	3	95	59	56	28	35	SCD171-0160-2-4-135HA30-HP246	30998822
1,70	3	95	59	56	28	33	SCD171-0170-2-4-135HA30-HP246	30998823
1,80	3	95	59	56	28	31	SCD171-0180-2-4-135HA30-HP246	30998824
1,90	3	100	66	63	28	33	SCD171-0190-2-4-135HA30-HP246	30998825
2,00	3	100	66	63	28	32	SCD171-0200-2-4-135HA30-HP246	30998826
2,10	3	100	66	62	28	30	SCD171-0210-2-4-135HA30-HP246	30998827
2,20	3	115	80	76	28	35	SCD171-0220-2-4-135HA30-HP246	30998828
2,30	3	115	80	76	28	33	SCD171-0230-2-4-135HA30-HP246	30998829
2,40	3	115	80	76	28	32	SCD171-0240-2-4-135HA30-HP246	30998830
2,50	3	115	80	76	28	30	SCD171-0250-2-4-135HA30-HP245	30451572
2,60	3	130	96	92	28	35	SCD171-0260-2-4-135HA30-HP246	30998832
2,70	3	130	96	91	28	34	SCD171-0270-2-4-135HA30-HP246	30998833
2,80	3	130	96	91	28	33	SCD171-0280-2-4-135HA30-HP246	30998834
2,90	3	130	96	91	28	31	SCD171-0290-2-4-135HA30-HP246	30998835

Fortsetzung auf nächster Seite.

Empfehlung für Pilotbohrer:

Bitte verwenden Sie als Pilotbohrer den MEGA-Pilot-Drill (SCD581) oder den MICRO-Drill-Steel (SCD371 - 5xD) mit dem gleichen Nenndurchmesser. Spitzenwinkel und Durchmesser-toleranzen sind für eine optimale Funktionalität sowie auf das Zusammenspiel von Pilotbohrer und Tiefbohrer abgestimmt.

MEGA-Deep-Drill | Vollhartmetall-Spiralbohrer SCD171 (20xD), innere Kühlmittelzufuhr

Konfigurierbare Merkmale



Durchmesser:
Durchmesser in Abstufungen
von 0,01 mm frei wählbar

**Spezifikation:**

SCD171-[Durchmesser]-2-4-135HA30-HP246

Beispiel:

SCD171-0221-2-4-135HA30-HP246

Werkzeughdurchmesser $d_1 = 2,21$ mm

Abmessungen konfigurierbare Baureihe

d_1 min.	d_1 max.	d_2 h6	l_1	l_2	l_3	l_4
1,00	1,29	3	75	38	36	28
1,30	1,39	3	85	50	48	28
1,40	1,59	3	85	50	47	28
1,60	1,89	3	95	59	56	28
1,90	2,09	3	100	66	63	28
2,10	2,19	3	100	66	62	28
2,20	2,59	3	115	80	76	28
2,60	2,69	3	130	96	92	28
2,70	2,99	3	130	96	91	28

Anwendungstechnische Hinweise zum Tiefbohren
finden Sie im Kapitel Technischer Anhang.

Maßangaben in mm.

Schnittwertempfehlung siehe Kapitelende.

Sonderausführungen und andere Beschichtungen auf Anfrage.

MEGA-Deep-Drill

Vollhartmetall-Spiralbohrer
SCD171 (15xD), innere Kühlmittelzufuhr

Ausführung:

Bohrerdurchmesser: 3,00 - 15,00 mm
Bohrungstoleranz: \geq IT 9
Schneidstoff: HP285 / HP245
Schneidenanzahl: 2
Anzahl Führungsfasen: 4
Spitzenwinkel: 135°
Spiralwinkel: 30°
Besonderheiten: Kopfbeschichtung

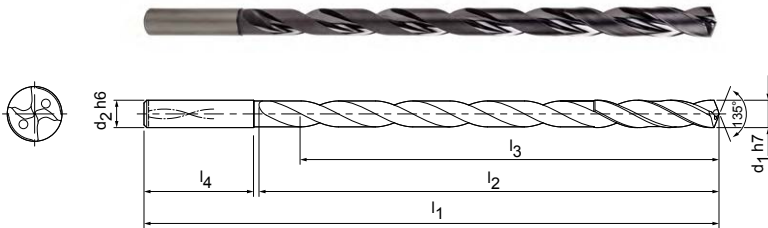

Lagerhaltige Vorzugsbaureihe in Schaftform HA

Baumaße						L/d- Verhältnis	Schaftform HA	
d ₁ h7	d ₂ h6	l ₁	l ₂	l ₃	l ₄		Spezifikation	Bestell-Nr.
3,00	4	90	56	52	32	17	SCD171-0300-2-4-135HA15-HP285	30392214
3,50	4	100	66	61	32	17	SCD171-0350-2-4-135HA15-HP285	30392215
4,00	4	100	66	60	32	15	SCD171-0400-2-4-135HA15-HP285	30392216
4,50	5	110	74	67	34	15	SCD171-0450-2-4-135HA15-HP285	30392217
5,00	5	120	84	77	34	15	SCD171-0500-2-4-135HA15-HP285	30392218
5,50	6	130	92	84	36	15	SCD171-0550-2-4-135HA15-HP285	30392219
6,00	6	140	102	93	36	16	SCD171-0600-2-4-135HA15-HP285	30392220
7,00	7	155	115	105	38	15	SCD171-0700-2-4-135HA15-HP285	30392221
8,00	8	175	133	121	40	15	SCD171-0800-2-4-135HA15-HP285	30392222
9,00	9	190	148	135	40	15	SCD171-0900-2-4-135HA15-HP285	30392223
9,50	10	210	168	153	40	15	SCD171-0950-2-4-135HA15-HP245	30453021
10,00	10	210	168	153	40	15	SCD171-1000-2-4-135HA15-HP285	30392224
11,00	11	230	183	167	45	15	SCD171-1100-2-4-135HA15-HP245	30392225
12,00	12	250	203	185	45	15	SCD171-1200-2-4-135HA15-HP245	30392226
13,00	13	265	218	199	45	15	SCD171-1300-2-4-135HA15-HP245	30392227
14,00	14	285	233	212	50	15	SCD171-1400-2-4-135HA15-HP245	30392228
15,00	15	305	253	231	50	15	SCD171-1500-2-4-135HA15-HP245	30392229

Empfehlung für Pilotbohrer:

Bitte verwenden Sie als Pilotbohrer für den MEGA-Drill-Steel-Plus (SCD601 - 3xD) mit dem gleichen Nenndurchmesser.

Spitzenwinkel und Durchmesser-toleranzen sind für eine optimale Funktionalität sowie auf das Zusammenspiel von Pilotbohrer und Tiefbohrer abgestimmt.

Anwendungstechnische Hinweise zum Tiefbohren finden Sie im Kapitel Technischer Anhang.

Maßangaben in mm.

Schnittwertempfehlung siehe Kapitelende.

Sonderausführungen und andere Beschichtungen auf Anfrage.

MEGA-Deep-Drill

Vollhartmetall-Spiralbohrer
SCD171 (20xD), innere Kühlmittelzufuhr

Ausführung:

- Bohrerdurchmesser: 3,00 – 16,00 mm
- Bohrungstoleranz: ≥ IT 9
- Schneidstoff: HP245 / HP285
- Schneidenanzahl: 2
- Anzahl Führungsfasen: 4
- Spitzenwinkel: 135°
- Spiralwinkel: 30°
- Besonderheiten: Kopfbeschichtung

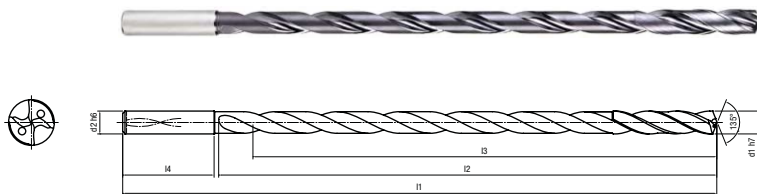

Lagerhaltige Vorzugsbaureihe in Schaftform HA

Baumaße						L/d-Verhältnis	Schaftform HA	
d ₁ h7	d ₂ h6	l ₁	l ₂	l ₃	l ₄		Spezifikation	Bestell-Nr.
3,00	4	110	74	70	32	23	SCD171-0300-2-4-135HA20-HP285	30392231
3,50	4	120	86	81	32	23	SCD171-0350-2-4-135HA20-HP285	30392232
4,00	4	120	86	80	32	20	SCD171-0400-2-4-135HA20-HP285	30392233
5,00	5	145	109	102	34	20	SCD171-0500-2-4-135HA20-HP285	30392235
5,50	6	160	120	112	36	20	SCD171-0550-2-4-135HA20-HP285	30392236
6,00	6	170	130	121	36	20	SCD171-0600-2-4-135HA20-HP285	30392237
6,50	7	190	150	140	36	20	SCD171-0650-2-4-135HA20-HP245	30451508
7,00	7	190	150	140	38	20	SCD171-0700-2-4-135HA20-HP285	30392238
8,00	8	215	173	161	40	20	SCD171-0800-2-4-135HA20-HP285	30392239
9,00	9	240	196	183	40	20	SCD171-0900-2-4-135HA20-HP285	30392240
10,00	10	260	218	203	40	20	SCD171-1000-2-4-135HA20-HP285	30392241
11,00	11	285	238	222	45	20	SCD171-1100-2-4-135HA20-HP245	30392242
12,00	12	305	258	240	45	20	SCD171-1200-2-4-135HA20-HP245	30392243
14,00	14	355	303	282	50	20	SCD171-1400-2-4-135HA20-HP245	30392245
15,00	15	375	323	301	50	20	SCD171-1500-2-4-135HA20-HP245	30392246
16,00	16	400	348	324	50	20	SCD171-1600-2-4-135HA20-HP245	30392247

Empfehlung für Pilotbohrer:

Bitte verwenden Sie als Pilotbohrer den MEGA-Drill-Steel-Plus (SCD601 - 3xD) mit dem gleichen Nenndurchmesser.

Spitzenwinkel und Durchmesser-toleranzen sind für eine optimale Funktionalität sowie auf das Zusammenspiel von Pilotbohrer und Tiefbohrer abgestimmt.

Anwendungstechnische Hinweise zum Tiefbohren finden Sie im Kapitel Technischer Anhang.

Maßangaben in mm.

Schnittwertempfehlung siehe Kapitelende.

Sonderausführungen und andere Beschichtungen auf Anfrage.

MEGA-Deep-Drill

Vollhartmetall-Spiralbohrer
SCD171 (25xD), innere Kühlmittelzufuhr

Ausführung:

Bohrerdurchmesser: 3,00 – 14,00 mm
Bohrungstoleranz: \geq IT 9
Schneidstoff: HP285 / HP245
Schneidenanzahl: 2
Anzahl Führungsfasen: 4
Spitzenwinkel: 135°
Spiralwinkel: 30°
Besonderheiten: Kopfbeschichtung

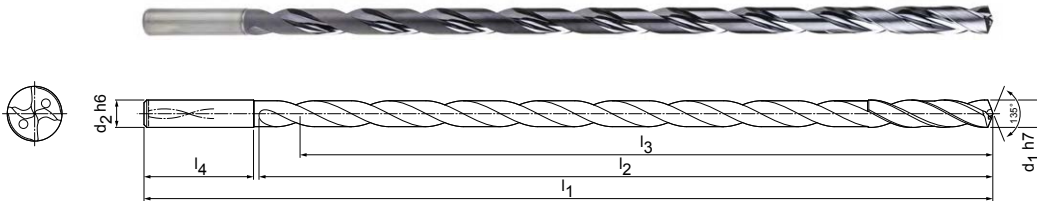

Lagerhaltige Vorzugsbaureihe in Schaftform HA

Baumaße						L/d-Verhältnis	Schaftform HA	
d ₁ h7	d ₂ h6	l ₁	l ₂	l ₃	l ₄		Spezifikation	Bestell-Nr.
3,00	4	125	91	87	32	29	SCD171-0300-2-4-135HA25-HP285	30392248
3,50	4	140	106	101	32	29	SCD171-0350-2-4-135HA25-HP285	30392249
4,00	4	140	106	100	32	25	SCD171-0400-2-4-135HA25-HP285	30392250
5,00	5	170	134	127	34	25	SCD171-0500-2-4-135HA25-HP285	30392252
5,50	6	185	147	139	36	25	SCD171-0550-2-4-135HA25-HP285	30392253
6,00	6	200	160	151	36	25	SCD171-0600-2-4-135HA25-HP285	30392254
7,00	7	225	185	175	38	25	SCD171-0700-2-4-135HA25-HP285	30392255
8,00	8	255	213	201	40	25	SCD171-0800-2-4-135HA25-HP285	30392256
9,00	9	280	238	225	40	25	SCD171-0900-2-4-135HA25-HP285	30392257
10,00	10	310	268	253	40	25	SCD171-1000-2-4-135HA25-HP285	30392258
11,00	11	340	293	277	45	25	SCD171-1100-2-4-135HA25-HP245	30392259
12,00	12	365	318	300	45	25	SCD171-1200-2-4-135HA25-HP245	30392260
14,00	14	425	373	352	50	25	SCD171-1400-2-4-135HA25-HP245	30392262

Empfehlung für Pilotbohrer:

Bitte verwenden Sie als Pilotbohrer den MEGA-Drill-Steel-Plus (SCD601 - 3xD) mit dem gleichen Nenndurchmesser.

Spitzenwinkel und Durchmesser-toleranzen sind für eine optimale Funktionalität sowie auf das Zusammenspiel von Pilotbohrer und Tiefbohrer abgestimmt.

Anwendungstechnische Hinweise zum Tiefbohren finden Sie im Kapitel Technischer Anhang.

Maßangaben in mm.

Schnittwertempfehlung siehe Kapitelende.

Sonderausführungen und andere Beschichtungen auf Anfrage.

MEGA-Deep-Drill

Vollhartmetall-Spiralbohrer
SCD171 (30xD), innere Kühlmittelzufuhr

Ausführung:
Bohrerdurchmesser: 3,00 – 12,00 mm
Bohrungstoleranz: \geq IT 9
Schneidstoff: HP245 / HP285
Schneidenanzahl: 2
Anzahl Führungsfasen: 4
Spitzenwinkel: 135°
Spiralwinkel: 30°
Besonderheiten: Kopfbeschichtung

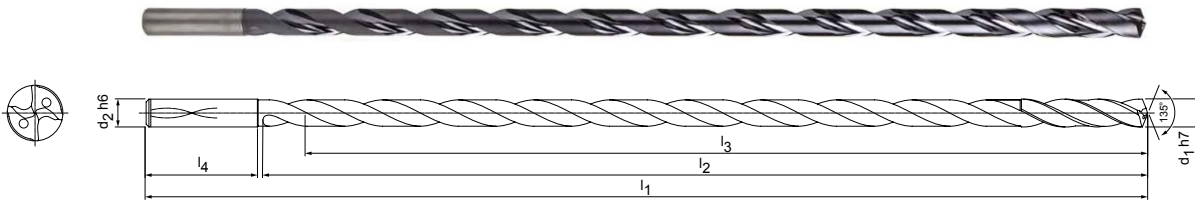

Performance LINE HA
IT9 30xD HA DIN 6535

P 1 2 3 4 5 6 M 1 2 3 K 1 2 3 N 1 2 3 4 S 1 2 3 4 5 H 1 2 3

Lagerhaltige Vorzugsbaureihe in Schaftform HA

Baumaße						L/d-Verhältnis	Schaftform HA	
d ₁ h7	d ₂ h6	l ₁	l ₂	l ₃	l ₄		Spezifikation	Bestell-Nr.
3,00	4	145	110	106	32	35	SCD171-0300-2-4-135HA30-HP285	30392264
4,00	4	160	126	120	32	30	SCD171-0400-2-4-135HA30-HP285	30392266
4,50	5	180	144	137	34	31	SCD171-0450-2-4-135HA30-HP285	30392267
5,00	5	195	159	152	34	30	SCD171-0500-2-4-135HA30-HP285	30392268
5,50	6	210	172	164	36	30	SCD171-0550-2-4-135HA30-HP285	30392269
6,00	6	230	192	183	36	31	SCD171-0600-2-4-135HA30-HP285	30392270
7,00	7	260	220	210	38	30	SCD171-0700-2-4-135HA30-HP285	30392271
8,00	8	295	253	241	40	30	SCD171-0800-2-4-135HA30-HP285	30392272
9,00	9	325	283	270	40	30	SCD171-0900-2-4-135HA30-HP285	30392273
10,00	10	360	318	303	40	30	SCD171-1000-2-4-135HA30-HP285	30392274
11,00	11	400	353	337	45	31	SCD171-1100-2-4-135HA30-HP245	30392275
12,00	12	430	383	365	45	30	SCD171-1200-2-4-135HA30-HP245	30392276

Empfehlung für Pilotbohrer:

Bitte verwenden Sie als Pilotbohrer den MEGA-Drill-Steel-Plus (SCD601 - 3xD) mit dem gleichen Nenndurchmesser.
Spitzenwinkel und Durchmesser-toleranzen sind für eine optimale Funktionalität sowie auf das Zusammenspiel von Pilotbohrer und Tiefbohrer abgestimmt.

Anwendungstechnische Hinweise zum Tiefbohren finden Sie im Kapitel Technischer Anhang.

Maßangaben in mm.
Schnittwertempfehlung siehe Kapitelende.
Sonderausführungen und andere Beschichtungen auf Anfrage.

MEGA-Deep-Drill

Vollhartmetall-Spiralbohrer
SCD171 (40xD), innere Kühlmittelzufuhr

Ausführung:

Bohrerdurchmesser: 4,00 – 6,00 mm
Bohrungstoleranz: \geq IT 9
Schneidstoff: HP285
Schneidenanzahl: 2
Anzahl Führungsfasen: 4
Spitzenwinkel: 130°
Spiralwinkel: 30°
Besonderheiten: Kopfbeschichtung

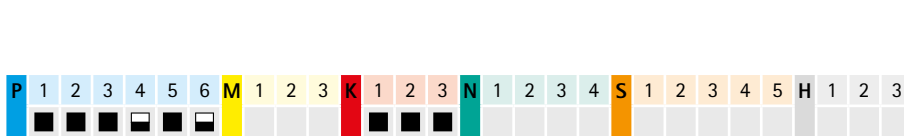
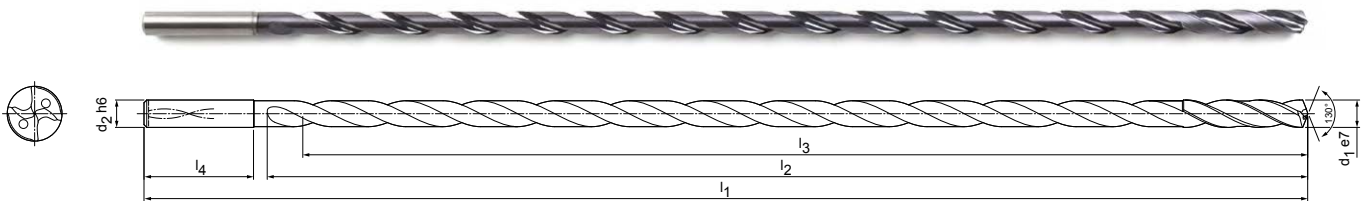

Lagerhaltige Vorzugsbaureihe in Schaftform HA

Baumaße						L/d- Verhältnis	Schaftform HA	
d ₁ e7	d ₂ h6	l ₁	l ₂	l ₃	l ₄		Spezifikation	Bestell-Nr.
4,00	4	205	170	164	32	43	SCD171-0400-2-4-130HA40-HP285	30549867
5,00	5	245	208	201	34	42	SCD171-0500-2-4-130HA40-HP285	30549869
6,00	6	290	250	241	36	42	SCD171-0600-2-4-130HA40-HP285	30549871

Empfehlung für Pilot- bzw. Vorbohrer:

Bitte verwenden Sie als Pilotbohrer den MEGA-Drill-Steel-Plus (SCD601 - 3xD) mit dem gleichen Nenndurchmesser. Anschließend mit MEGA-Deep-Drill (SCD171 - 20xD) und ebenfalls gleichem Nenndurchmesser vorbohren. Spitzenwinkel und Durchmesser sind für eine optimale Funktionalität sowie auf das Zusammenspiel von Pilotbohrer und Tiefbohrer abgestimmt.

Anwendungstechnische Hinweise zum Tiefbohren
finden Sie im Kapitel Technischer Anhang.

Maßangaben in mm.

Schnittwertempfehlung siehe Kapitelende.

Sonderausführungen und andere Beschichtungen auf Anfrage.

MEGA-Deep-Drill-Alu

Vollhartmetall-Spiralbohrer
SCD181 (15xD), innere Kühlmittelzufuhr

Ausführung:

Bohrerdurchmesser: 3,00 – 12,00 mm
Bohrungstoleranz: ≥ IT 9
Schneidstoff: HU680 / HU644
Schneidenanzahl: 2
Anzahl Führungsfasen: 4
Spitzenwinkel: 135°
Spiralwinkel: 30°

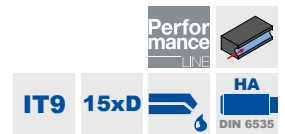
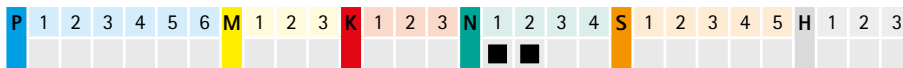
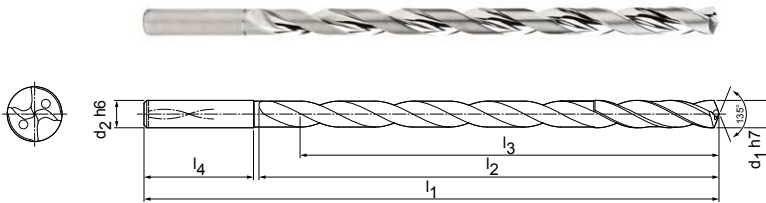

Lagerhaltige Vorzugsbaureihe in Schaftform HA

Baumaße						L/d-Verhältnis	Schaftform HA	
d ₁ h7	d ₂ h6	l ₁	l ₂	l ₃	l ₄		Spezifikation	Bestell-Nr.
3,00	4	90	56	52	32	17	SCD181-0300-2-4-135HA15-HU680	30392277
3,50	4	100	66	61	32	17	SCD181-0350-2-4-135HA15-HU680	30392278
4,00	4	100	66	60	32	15	SCD181-0400-2-4-135HA15-HU680	30392279
5,00	5	120	84	77	34	15	SCD181-0500-2-4-135HA15-HU680	30392281
6,00	6	140	102	93	36	16	SCD181-0600-2-4-135HA15-HU680	30392283
7,00	7	155	115	105	38	15	SCD181-0700-2-4-135HA15-HU680	30392284
8,00	8	175	133	121	40	15	SCD181-0800-2-4-135HA15-HU680	30392285
10,00	10	210	168	153	40	15	SCD181-1000-2-4-135HA15-HU680	30392287
12,00	12	250	203	185	45	15	SCD181-1200-2-4-135HA15-HU644	30392289

Empfehlung für Pilotbohrer:

Bitte verwenden Sie als Pilotbohrer den MEGA-Drill-Alu (SCD131 - 3xD/5xD) mit dem gleichen Nenndurchmesser.

Spitzenwinkel und Durchmesser-toleranzen sind für eine optimale Funktionalität sowie auf das Zusammenspiel von Pilotbohrer und Tiefbohrer abgestimmt.

Anwendungstechnische Hinweise zum Tiefbohren finden Sie im Kapitel Technischer Anhang.

Maßangaben in mm.

Schnittwertempfehlung siehe Kapitelende.

Sonderausführungen und andere Beschichtungen auf Anfrage.

MEGA-Deep-Drill-Alu

Vollhartmetall-Spiralbohrer
SCD181 (20xD), innere Kühlmittelzufuhr

Ausführung:

Bohrerdurchmesser: 3,00 – 12,00 mm
Bohrungstoleranz: \geq IT 9
Schneidstoff: HU680 / HU644
Schneidenanzahl: 2
Anzahl Führungsfasen: 4
Spitzenwinkel: 135°
Spiralwinkel: 30°

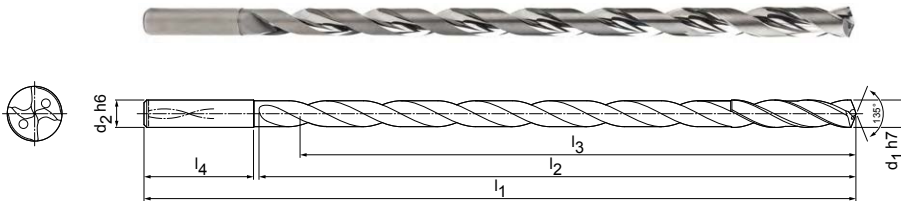

Lagerhaltige Vorzugsbaureihe in Schaftform HA

Baumaße						L/d-Verhältnis	Schaftform HA	
d ₁ h7	d ₂ h6	l ₁	l ₂	l ₃	l ₄		Spezifikation	Bestell-Nr.
3,00	4	110	74	70	32	23	SCD181-0300-2-4-135HA20-HU680	30392294
4,00	4	120	86	80	32	20	SCD181-0400-2-4-135HA20-HU680	30392296
5,00	5	145	109	102	34	20	SCD181-0500-2-4-135HA20-HU680	30392298
5,50	6	160	120	112	36	20	SCD181-0550-2-4-135HA20-HU680	30392299
6,00	6	170	130	121	36	20	SCD181-0600-2-4-135HA20-HU680	30392300
7,00	7	190	150	140	38	20	SCD181-0700-2-4-135HA20-HU680	30392301
8,00	8	215	173	161	40	20	SCD181-0800-2-4-135HA20-HU680	30392302
10,00	10	260	218	203	40	20	SCD181-1000-2-4-135HA20-HU680	30392304
12,00	12	305	258	240	45	20	SCD181-1200-2-4-135HA20-HU644	30392306

Empfehlung für Pilotbohrer:

Bitte verwenden Sie als Pilotbohrer den MEGA-Drill-Alu (SCD131 - 3xD/5xD) mit dem gleichen Nenndurchmesser.

Spitzenwinkel und Durchmesser toleranzen sind für eine optimale Funktionalität sowie auf das Zusammenspiel von Pilotbohrer und Tiefbohrer abgestimmt.

Anwendungstechnische Hinweise zum Tiefbohren finden Sie im Kapitel Technischer Anhang.

Maßangaben in mm.

Schnittwertempfehlung siehe Kapitelende.

Sonderausführungen und andere Beschichtungen auf Anfrage.

MEGA-Deep-Drill-Alu

Vollhartmetall-Spiralbohrer
SCD181 (25xD), innere Kühlmittelzufuhr

Ausführung:

Bohrerdurchmesser: 3,00 – 10,00 mm
Bohrungstoleranz: ≥ IT 9
Schneidstoff: HU680
Schneidenanzahl: 2
Anzahl Führungsfasen: 4
Spitzenwinkel: 135°
Spiralwinkel: 30°

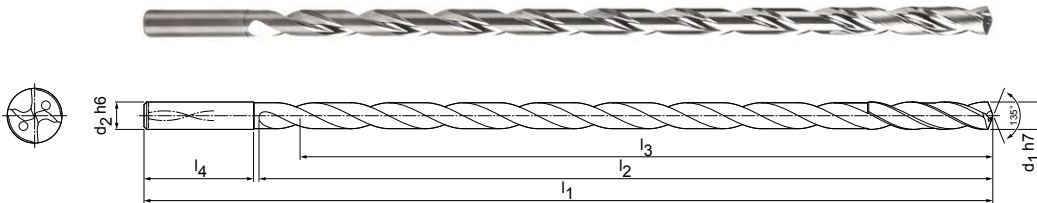

Lagerhaltige Vorzugsbaureihe in Schaftform HA

Baumaße						L/d-Verhältnis	Schaftform HA	
d ₁ h7	d ₂ h6	l ₁	l ₂	l ₃	l ₄		Spezifikation	Bestell-Nr.
3,00	4	125	91	87	32	29	SCD181-0300-2-4-135HA25-HU680	30392311
4,00	4	140	106	100	32	25	SCD181-0400-2-4-135HA25-HU680	30392313
5,00	5	170	134	127	34	25	SCD181-0500-2-4-135HA25-HU680	30392315
6,00	6	200	160	151	36	25	SCD181-0600-2-4-135HA25-HU680	30392317
7,00	7	225	185	175	38	25	SCD181-0700-2-4-135HA25-HU680	30392318
8,00	8	255	213	201	40	25	SCD181-0800-2-4-135HA25-HU680	30392319
10,00	10	310	268	253	40	25	SCD181-1000-2-4-135HA25-HU680	30392321

Empfehlung für Pilotbohrer:

Bitte verwenden Sie als Pilotbohrer den MEGA-Drill-Alu (SCD131 - 3xD/5xD) mit dem gleichen Nenndurchmesser.

Spitzenwinkel und Durchmesser-toleranzen sind für eine optimale Funktionalität sowie auf das Zusammenspiel von Pilotbohrer und Tiefbohrer abgestimmt.

Anwendungstechnische Hinweise zum Tiefbohren finden Sie im Kapitel Technischer Anhang.

Maßangaben in mm.
Schnittwertempfehlung siehe Kapitelende.
Sonderausführungen und andere Beschichtungen auf Anfrage.

MEGA-Deep-Drill-Alu

Vollhartmetall-Spiralbohrer
SCD181 (30xD), innere Kühlmittelzufuhr

Ausführung:

Bohrerdurchmesser: 4,00 - 6,00 mm
Bohrungstoleranz: \geq IT 9
Schneidstoff: HU680
Schneidenanzahl: 2
Anzahl Führungsfasen: 4
Spitzenwinkel: 135°
Spiralwinkel: 30°

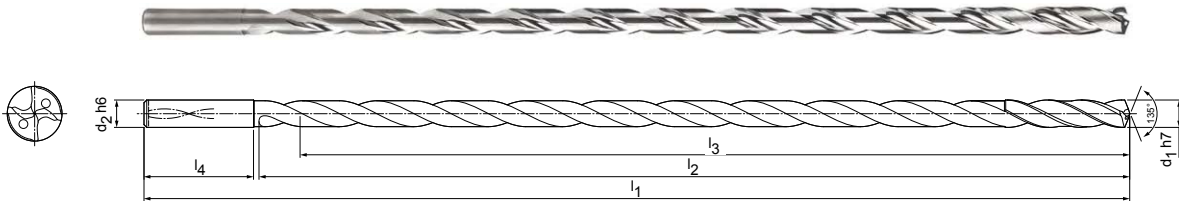

Lagerhaltige Vorzugsbaureihe in Schaftform HA

Baumaße						L/d- Verhältnis	Schaftform HA	
d ₁ h7	d ₂ h6	l ₁	l ₂	l ₃	l ₄		Spezifikation	Bestell-Nr.
4,00	4	160	126	120	32	30	SCD181-0400-2-4-135HA30-HU680	30392328
4,50	5	180	144	137	34	31	SCD181-0450-2-4-135HA30-HU680	30392329
5,00	5	195	159	152	34	30	SCD181-0500-2-4-135HA30-HU680	30392330
6,00	6	230	192	183	36	31	SCD181-0600-2-4-135HA30-HU680	30392332

Empfehlung für Pilotbohrer:

Bitte verwenden Sie als Pilotbohrer den MEGA-Drill-Alu (SCD131 - 3xD/5xD) mit dem gleichen Nenndurchmesser.

Spitzenwinkel und Durchmesser-toleranzen sind für eine optimale Funktionalität sowie auf das Zusammenspiel von Pilotbohrer und Tiefbohrer abgestimmt.

Anwendungstechnische Hinweise zum Tiefbohren finden Sie im Kapitel Technischer Anhang.

Maßangaben in mm.

Schnittwertempfehlung siehe Kapitelende.

Sonderausführungen und andere Beschichtungen auf Anfrage.

MEGA-Deep-Drill-Alu



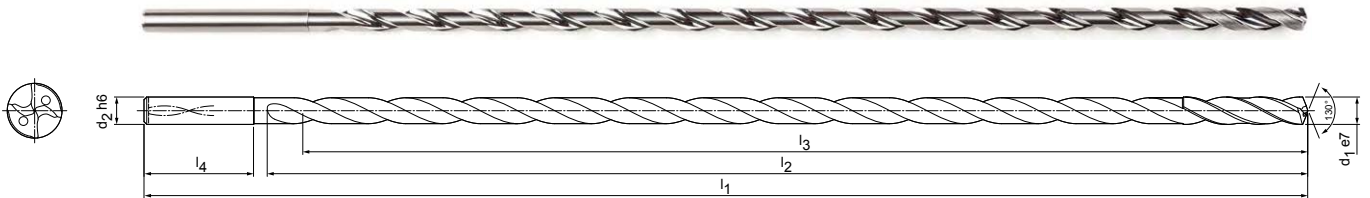

Vollhartmetall-Spiralbohrer
SCD181 (40xD), innere Kühlmittelzufuhr

Ausführung:

Bohrerdurchmesser: 6,00 - 7,00 mm
Bohrungstoleranz: \geq IT 9
Schneidstoff: HU680
Schneidenanzahl: 2
Anzahl Führungsfasen: 4
Spitzenwinkel: 130°
Spiralwinkel: 30°



P
1
2
3
4
5
6
M
1
2
3
K
1
2
3
N
1
2
3
4
S
1
2
3
4
5
H
1
2
3

Lagerhaltige Vorzugsbaureihe in Schaftform HA

Baumaße						L/d-Verhältnis	Schaftform HA	
d ₁ h7	d ₂ h6	l ₁	l ₂	l ₃	l ₄		Spezifikation	Bestell-Nr.
6,00	6	290	250	241	36	42	SCD181-0600-2-4-130HA40-HU680	30549881
7,00	7	330	290	280	38	41	SCD181-0700-2-4-130HA40-HU680	30549882

Empfehlung für Pilotbohrer:

Bitte verwenden Sie als Pilotbohrer den MEGA-Drill-Alu (SCD131 - 3xD/5xD) mit dem gleichen Nenndurchmesser.
Spitzenwinkel und Durchmesser-toleranzen sind für eine optimale Funktionalität sowie auf das Zusammenspiel von Pilotbohrer und Tiefbohrer abgestimmt.

Anwendungstechnische Hinweise zum Tiefbohren finden Sie im Kapitel Technischer Anhang.

Maßangaben in mm.
Schnittwertempfehlung siehe Kapitelende.
Sonderausführungen und andere Beschichtungen auf Anfrage.



Schnittwertempfehlung für Tiefbohrer

Vorschub und Schnittgeschwindigkeit

MEGA-Pilot-Drill | SCD581

MZG*	Werkstoff	Festigkeit/Härte [N/mm ²] [HRC]
P	P1.1 Bau-, Automaten-, Einsatz- und Vergütungsstähle, unlegiert	< 700
	P1.2 Bau-, Automaten-, Einsatz- und Vergütungsstähle, unlegiert	< 1.200
	P2.1 Nitrier-, Einsatz- und Vergütungsstähle, legiert	< 900
	P2.2 Nitrier-, Einsatz- und Vergütungsstähle, legiert	< 1.400
	P3.1 Werkzeug-, Wälzlager-, Feder- und Schnellarbeitsstähle**	< 800
	P3.2 Werkzeug-, Wälzlager-, Feder- und Schnellarbeitsstähle**	< 1.000
	P3.3 Werkzeug-, Wälzlager-, Feder- und Schnellarbeitsstähle**	< 1.500
	P5.1 Stahlguss	
M	M1.1 Rostfreie Stähle, austenitisch	< 700
	M1.2 Rostfreie Stähle, ferritisch/austenitisch (Duplex)	< 1.000
K	K1.1 Gusseisen mit Lamellengraphit (Grauguss), GJL	< 300
	K2.1 Gusseisen mit Kugelgraphit, GJS	< 500
	K2.2 Gusseisen mit Kugelgraphit, GJS	≤ 800
	K2.3 Gusseisen mit Kugelgraphit, GJS	> 800
	K3.1 Gusseisen mit Vermiculargraphit, GJV; Temperguss, GJM	< 500
	K3.2 Gusseisen mit Vermiculargraphit, GJV; Temperguss, GJM	> 500

* MAPAL Zerspanungsgruppen

** Wenn die Legierungsbestandteile Cr, Mo, Ni, V, W in Summe > 8 %, dann die nächst höhere MAPAL Zerspanungsgruppe wählen.

	Schnittgeschwindigkeit v_c [m/min]				Vorschub f [mm] bei Bohrerdurchmesser					
	Innenkühlung	Außenkühlung	MMS	Luft	1,00	1,20	1,60	1,90	2,40	3,00
	80	70	70		0,05	0,06	0,06	0,07	0,08	0,09
	70	60	60		0,07	0,07	0,08	0,09	0,10	0,11
	80	70	70		0,06	0,07	0,08	0,08	0,10	0,11
	55	50	50		0,06	0,06	0,07	0,07	0,08	0,09
	60	50	50		0,06	0,06	0,07	0,07	0,08	0,10
	50	45	45		0,05	0,05	0,06	0,07	0,07	0,08
	50	35	40		0,05	0,05	0,05	0,06	0,06	0,07
	80	70	70		0,06	0,07	0,08	0,08	0,10	0,11
	45	30	30		0,04	0,04	0,05	0,05	0,06	0,06
	95	70	70	70	0,06	0,07	0,08	0,09	0,10	0,12
	130	80	95	95	0,07	0,07	0,08	0,09	0,11	0,13
	80	60	60		0,06	0,07	0,08	0,09	0,10	0,11
	70	65	65		0,07	0,08	0,08	0,09	0,11	0,12
	65	55	55		0,06	0,07	0,08	0,08	0,09	0,11

Die angegebenen Schnittwerte sind Richtwerte.

Die für den jeweiligen Bearbeitungsfall optimalen Daten sollten im Versuch oder während der Bearbeitung ermittelt werden.

Schnittwertempfehlung für Tiefbohrer

Vorschub und Schnittgeschwindigkeit

MEGA-Deep-Drill | SCD171

MZG*	Werkstoff	Festigkeit/Härte [N/mm ²] [HRC]
P	P1.1 Bau-, Automaten-, Einsatz- und Vergütungsstähle, unlegiert	< 700
	P1.2 Bau-, Automaten-, Einsatz- und Vergütungsstähle, unlegiert	< 1.200
	P2.1 Nitrier-, Einsatz- und Vergütungsstähle, legiert	< 900
	P2.2 Nitrier-, Einsatz- und Vergütungsstähle, legiert	< 1.400
	P3.1 Werkzeug-, Wälzlager-, Feder- und Schnellarbeitsstähle**	< 800
	P3.2 Werkzeug-, Wälzlager-, Feder- und Schnellarbeitsstähle**	< 1.000
	P3.3 Werkzeug-, Wälzlager-, Feder- und Schnellarbeitsstähle**	< 1.500
	P5.1 Stahlguss	
K	K1.1 Gusseisen mit Lamellengraphit (Grauguss), GJL	< 300
	K2.1 Gusseisen mit Kugelgraphit, GJS	< 500
	K2.2 Gusseisen mit Kugelgraphit, GJS	≤ 800
	K2.3 Gusseisen mit Kugelgraphit, GJS	> 800
	K3.1 Gusseisen mit Vermiculargraphit, GJV; Temperguss, GJM	< 500
	K3.2 Gusseisen mit Vermiculargraphit, GJV; Temperguss, GJM	> 500

MEGA-Deep-Drill-Alu | SCD181

MZG*	Werkstoff	Festigkeit/Härte [N/mm ²] [HRC]
N	N1.1 Aluminium, unlegiert und legiert < 3 % Si	
	N1.2 Aluminium, legiert ≤ 7 % Si	
	N1.3 Aluminium, legiert > 7-12 % Si	
	N1.4 Aluminium, legiert > 12 % Si	
	N2.1 Kupfer, unlegiert und niedriglegiert	< 300
	N2.2 Kupfer, legiert	> 300
	N2.3 Messing, Bronze, Rotguss	< 1.200

* MAPAL Zerspanungsgruppen

** Wenn die Legierungsbestandteile Cr, Mo, Ni, V, W in Summe > 8 %, dann die nächst höhere MAPAL Zerspanungsgruppe wählen.

	Schnittgeschwindigkeit v_c [m/min]				Vorschub f [mm] bei Bohrerdurchmesser					
	Innenkühlung	Außenkühlung	MMS	Luft	1,00	2,00	4,00	6,00	9,00	16,00
	90	80	80		0,04	0,06	0,09	0,13	0,19	0,27
	80	70	70		0,06	0,08	0,11	0,16	0,24	0,34
	90	75	75		0,05	0,07	0,10	0,16	0,23	0,32
	65	55	55		0,05	0,07	0,09	0,13	0,18	0,25
	70	60	60		0,05	0,06	0,09	0,14	0,21	0,29
	55	50	50		0,04	0,06	0,08	0,12	0,17	0,23
	55	40	45		0,04	0,05	0,07	0,09	0,13	0,18
	90	75	75		0,05	0,07	0,10	0,16	0,23	0,32
	110	75	75	75	0,14	0,18	0,25	0,32	0,41	0,53
	145	90	110	110	0,14	0,18	0,24	0,30	0,38	0,49
	90	70	70		0,13	0,16	0,21	0,26	0,33	0,42
	55	35	45		0,10	0,12	0,14	0,18	0,22	0,28
	80	70	70		0,14	0,18	0,22	0,28	0,36	0,46
	70	65	65		0,12	0,15	0,18	0,23	0,29	0,36

	Schnittgeschwindigkeit v_c [m/min]				Vorschub f [mm] bei Bohrerdurchmesser					
	Innenkühlung	Außenkühlung	MMS	Luft	3,00	4,00	5,50	7,50	10,50	16,00
	300	200	250		0,11	0,13	0,16	0,20	0,25	0,32
	250	180	200		0,13	0,16	0,21	0,26	0,33	0,42
	220	150	180		0,13	0,16	0,21	0,26	0,33	0,42
	180	120	150		0,13	0,16	0,21	0,26	0,33	0,42
	140	100			0,09	0,11	0,14	0,17	0,21	0,27
	120	90			0,11	0,14	0,17	0,22	0,28	0,35
	200	160	160	120	0,14	0,18	0,25	0,32	0,41	0,53

Die angegebenen Schnittwerte sind Richtwerte.

Die für den jeweiligen Bearbeitungsfall optimalen Daten sollten im Versuch oder während der Bearbeitung ermittelt werden.



BOHRREIBEN

Bohrreibahlen

Technologie 290

Tritan-Drill-Reamer 292

Technischer Anhang

Schnittwertempfehlung 298

TRITAN-DRILL-REAMER

Die genaueste Lösung zum Bohren und Reiben in einem Arbeitsgang

Um möglichst wirtschaftlich zu fertigen, ist es ein bewährtes Mittel, mehrere Bearbeitungsschritte in einem Werkzeug zusammenzufassen. So können beispielsweise Bohrungen mit dem Tritan-Drill-Reamer von MAPAL gleichzeitig gebohrt und gerieben werden.

Um Passungsbohrungen noch genauer mit nur einem Werkzeug herstellen zu können, hat MAPAL den Tritan-Drill-Reamer entwickelt.

Mit sechs Führungsfasen für exzellente Führungseigenschaften, feinstgeschliffenen Spannuten mit abgestimmter Nutform für gute Spanabfuhr und einer selbstzentrierenden Querschnitte überzeugt der neue Tritan-Drill-Reamer auf ganzer Linie.

Die selbstzentrierende Querschnitte sorgt für gute Positionsgenauigkeit und ein verbessertes Anbohrverhalten. Drei Schneiden garantieren eine optimale Rundheit der Passungsbohrung und höchste Leistungsfähigkeit. Die Führungsfasen erzeugen beste Oberflächen.

MERKMALE

- Kombination aus Bohren und Reiben
- Längenausführung 3xD und 5xD
- Drei Schneiden und sechs Führungsfasen
- Mit Innenkühlung
- Toleranzausführungen $\pm 0,003$ mm und H7

VORTEILE

- Reduzierte Haupt- und Nebenzeiten
- Beste Performance und höchste Genauigkeiten
- Hohe Positionsgenauigkeit
- Optimale Rundheit

Werkzeugfeatures im Detail

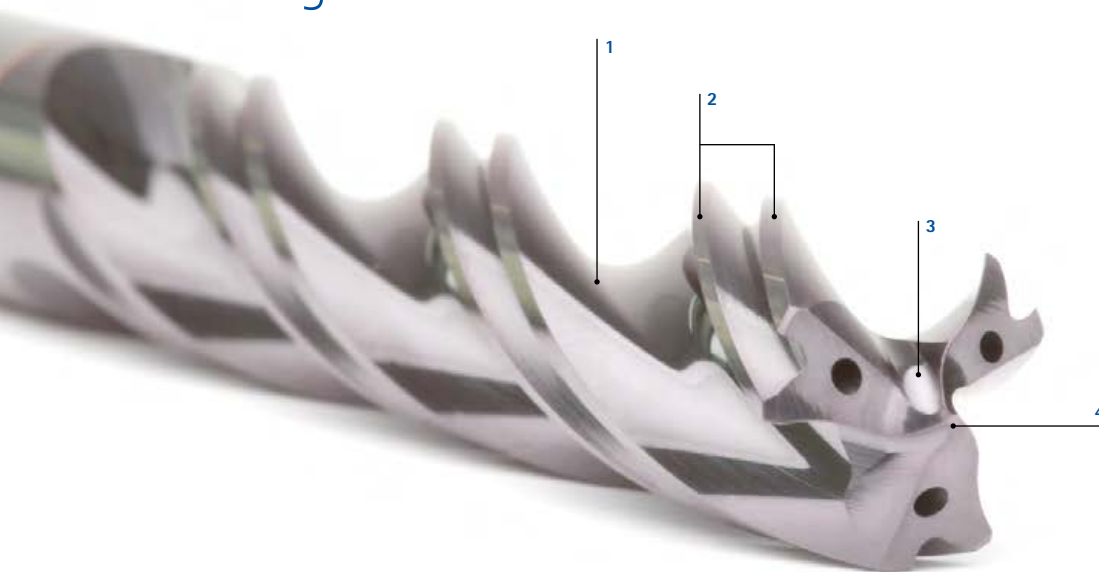

- 1 Feinstgeschliffenes Nutprofil
- 2 Sechs Führungsfasen
- 3 Innovative Ausspitzung
- 4 Selbstzentrierende Querschnitte



Sechs Führungsfasen

- Für exzellente Führungseigenschaften
- Zur Herstellung von Passungsbohrungen mit höchster Wirtschaftlichkeit und Genauigkeit mit nur einem Werkzeug



Innovative Zentrierspitze

- Selbstzentrierende Querschnitte für sehr gute Positionsgenauigkeit und verbessertes Anbohrverhalten



Feinstgeschliffenes Nutprofil

- Feinstgeschliffene Spannuten mit abgestimmter Nutform für sehr gute Spanabfuhr



Vergleich Tritan-Drill-Reamer und zweischneidige Lösung

Durchmesserabweichung vom gemessenen Werkzeugdurchmesser (42CrMoS4)

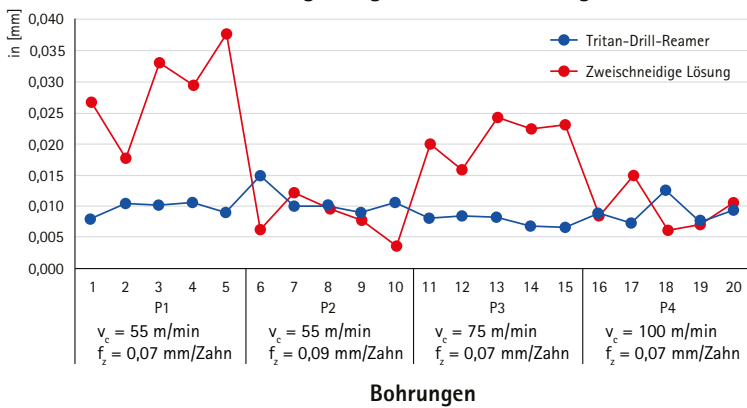

Rundheit über 600 Bohrungen

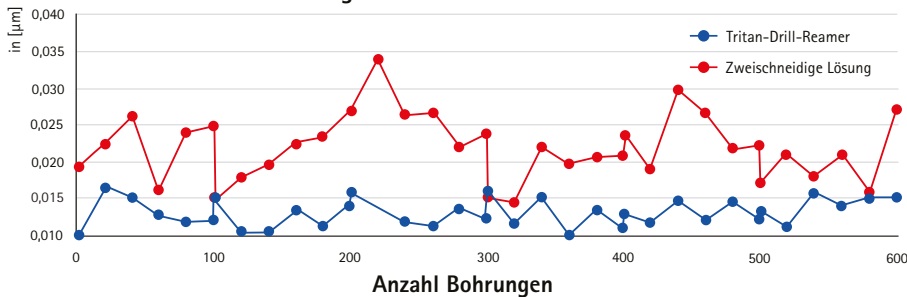

Tritan-Drill-Reamer

Bohrreibahle
SDR301G (3xD), innere Kühlmittelzufuhr

Ausführung:
Bohrerdurchmesser: 3,80 – 20,05 mm
Bohrungstoleranz: ≥ IT 7
Schneidstoff: HP358
Schneidenanzahl: 3
Anzahl Führungsfasen: 6
Spitzenwinkel: 140°
Spiralwinkel: 30°

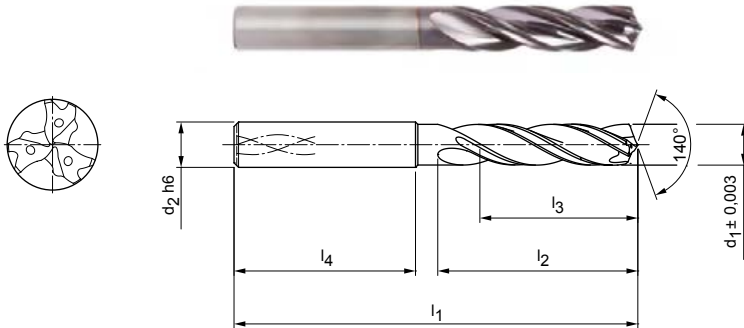

Lagerhaltige Vorzugsbaureihe in Schaftform HA

Baumaße						Schaftform HA	
d ₁ +/-0,003	d ₂ h6	l ₁	l ₂	l ₃	l ₄	Spezifikation	Bestell-Nr.
3,99	6	66	24	17	36	SDR301G-3.990+3-3-HA03-HP358	31196569
4,00	6	66	24	17	36	SDR301G-4.000+3-3-HA03-HP358	31196570
4,01	6	66	24	17	36	SDR301G-4.010+3-3-HA03-HP358	31196571
4,99	6	66	28	20	36	SDR301G-4.990+3-3-HA03-HP358	31196575
5,00	6	66	28	20	36	SDR301G-5.000+3-3-HA03-HP358	31196576
5,01	6	66	28	20	36	SDR301G-5.010+3-3-HA03-HP358	31196577
5,02	6	66	28	20	36	SDR301G-5.020+3-3-HA03-HP358	31196578
5,99	6	66	28	20	36	SDR301G-5.990+3-3-HA03-HP358	31196581
6,00	6	66	28	20	36	SDR301G-6.000+3-3-HA03-HP358	31196582
6,01	6	66	28	20	36	SDR301G-6.010+3-3-HA03-HP358	31196583
7,99	8	79	41	29	36	SDR301G-7.990+3-3-HA03-HP358	31196587
8,00	8	79	41	29	36	SDR301G-8.000+3-3-HA03-HP358	31196588
8,01	8	79	41	29	36	SDR301G-8.010+3-3-HA03-HP358	31196589
9,99	10	89	47	35	40	SDR301G-9.990+3-3-HA03-HP358	31196593
10,00	10	89	47	35	40	SDR301G-10.000+3-3-HA03-HP358	31196594
10,01	10	89	47	35	40	SDR301G-10.010+3-3-HA03-HP358	31196595
10,02	10	89	47	35	40	SDR301G-10.020+3-3-HA03-HP358	31196596
11,99	12	102	55	40	45	SDR301G-11.990+3-3-HA03-HP358	31196599
12,00	12	102	55	40	45	SDR301G-12.000+3-3-HA03-HP358	31196600
12,01	12	102	55	40	45	SDR301G-12.010+3-3-HA03-HP358	31196601
13,99	14	107	60	43	45	SDR301G-13.990+3-3-HA03-HP358	31196605
14,00	14	107	60	43	45	SDR301G-14.000+3-3-HA03-HP358	31196606
14,01	14	107	60	43	45	SDR301G-14.010+3-3-HA03-HP358	31196607
15,99	16	115	65	45	48	SDR301G-15.990+3-3-HA03-HP358	31196611
16,00	16	115	65	45	48	SDR301G-16.000+3-3-HA03-HP358	31196612
16,01	16	115	65	45	48	SDR301G-16.010+3-3-HA03-HP358	31196613

Tritan-Drill-Reamer | Bohrreibahle SDR301G (3xD), innere Kühlmittelzufuhr

Konfigurierbare Merkmale



Durchmesser:
Durchmesser in Abstufungen
von 0,001 mm frei wählbar

**Spezifikation:**

SDR301G-[Durchmesser]+3-3-HA03-HP358

Beispiel:

SDR301G-4.001+3-3-HA03-HP358

Werkzeugdurchmesser $d_1 = 4,001$ mm

Abmessungen konfigurierbare Baureihe

d_1 min.	d_1 max.	d_2 h6	l_1	l_2	l_3	l_4
3,800	4,700	6	66	24	17	36
4,701	6,050	6	66	28	20	36
6,051	8,050	8	79	41	29	36
8,051	10,050	10	89	47	35	40
10,051	12,050	12	102	55	40	45
12,970	14,050	14	107	60	43	45
14,970	16,050	16	115	65	45	48
16,800	18,050	18	123	73	51	48
18,700	20,050	20	131	79	55	50

Maßangaben in mm.

Für Passungsbohrungen der Toleranzklassen bis max. IT7, bei ausreichender Maschinenstabilität und Kühlung.

Die Hilfe zur Berechnung des optimalen Nenndurchmessers für unterschiedliche Passungsbohrungen entnehmen Sie bitte dem Informationsfeld am Kapitelende.

Schnittwertempfehlung siehe Kapitelende.

Sonderausführungen und andere Beschichtungen auf Anfrage.

Tritan-Drill-Reamer

Bohrreibahle
SDR301 (3xD), innere Kühlmittelzufuhr

Ausführung:
Bohrerdurchmesser: 4,00 – 16,00 mm
Bohrungstoleranz: \geq IT 7
Schneidstoff: HP358
Schneidenanzahl: 3
Anzahl Führungsfasen: 6
Spitzenwinkel: 140°
Spiralwinkel: 30°

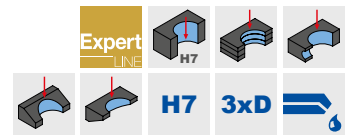
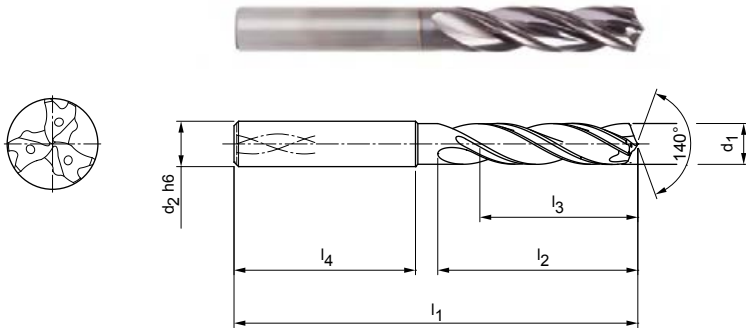

Lagerhaltige Vorzugsbaureihe in Schaftform HA

Baumaße						Schaftform HA	
d ₁ H7	d ₂ h6	l ₁	l ₂	l ₃	l ₄	Spezifikation	Bestell-Nr.
4,00	6	66	24	17	36	SDR301-4.000H7-HA03-HP358	31196337
5,00	6	66	28	20	36	SDR301-5.000H7-HA03-HP358	31196338
6,00	6	66	28	20	36	SDR301-6.000H7-HA03-HP358	31196339
8,00	8	79	41	29	36	SDR301-8.000H7-HA03-HP358	31196560
10,00	10	89	47	35	40	SDR301-10.000H7-HA03-HP358	31196561
12,00	12	102	55	40	45	SDR301-12.000H7-HA03-HP358	31196562
14,00	14	107	60	43	45	SDR301-14.000H7-HA03-HP358	31196563
16,00	16	115	65	45	48	SDR301-16.000H7-HA03-HP358	31196564

Maßangaben in mm.
Für Passungsbohrungen der Toleranzklasse H7, bei ausreichender Maschinenstabilität und Kühlung.
Schnittwertempfehlung siehe Kapitelende.
Sonderausführungen und andere Beschichtungen auf Anfrage.

Tritan-Drill-Reamer

Bohrreibahle

SDR301G (5xD), innere Kühlmittelzufuhr

Ausführung:

Bohrerdurchmesser: 3,80 – 20,05 mm
 Bohrungstoleranz: \geq IT 7
 Schneidstoff: HP358
 Schneidenanzahl: 3
 Anzahl Führungsfasen: 6
 Spitzenwinkel: 140°
 Spiralwinkel: 30°

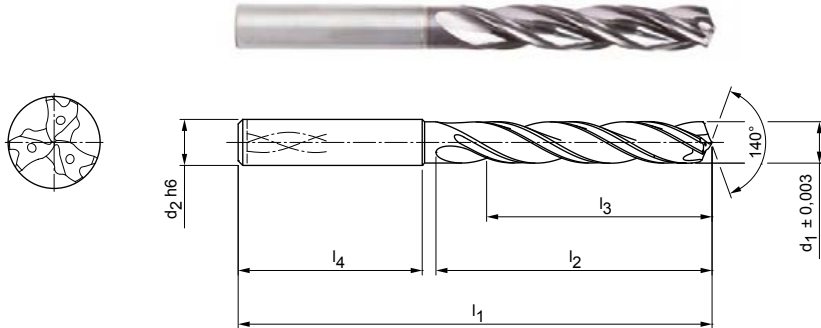

Lagerhaltige Vorzugsbaureihe in Schaftform HA

Baumaße						Schaftform HA	
$d_1 \pm 0,003$	$d_2 h6$	l_1	l_2	l_3	l_4	Spezifikation	Bestell-Nr.
3,99	6	74	36	29	36	SDR301G-3.990+3-3-HA05-HP358	31196639
4,00	6	74	36	29	36	SDR301G-4.000+3-3-HA05-HP358	31196640
4,01	6	74	36	29	36	SDR301G-4.010+3-3-HA05-HP358	31196641
4,02	6	74	36	29	36	SDR301G-4.020+3-3-HA05-HP358	31196642
4,99	6	82	44	35	36	SDR301G-4.990+3-3-HA05-HP358	31196645
5,00	6	82	44	35	36	SDR301G-5.000+3-3-HA05-HP358	31196646
5,01	6	82	44	35	36	SDR301G-5.010+3-3-HA05-HP358	31196647
5,99	6	82	44	35	36	SDR301G-5.990+3-3-HA05-HP358	31196651
6,00	6	82	44	35	36	SDR301G-6.000+3-3-HA05-HP358	31196652
6,01	6	82	44	35	36	SDR301G-6.010+3-3-HA05-HP358	31196653
7,99	8	91	53	43	36	SDR301G-7.990+3-3-HA05-HP358	31196658
8,00	8	91	53	43	36	SDR301G-8.000+3-3-HA05-HP358	31196659
8,01	8	91	53	43	36	SDR301G-8.010+3-3-HA05-HP358	31196660
8,02	8	91	53	43	36	SDR301G-8.020+3-3-HA05-HP358	31196661
9,99	10	103	61	49	40	SDR301G-9.990+3-3-HA05-HP358	31196664
10,00	10	103	61	49	40	SDR301G-10.000+3-3-HA05-HP358	31196665
10,01	10	103	61	49	40	SDR301G-10.010+3-3-HA05-HP358	31196666
11,99	12	118	71	59	45	SDR301G-11.990+3-3-HA05-HP358	31196670
12,00	12	118	71	59	45	SDR301G-12.000+3-3-HA05-HP358	31196671
12,01	12	118	71	59	45	SDR301G-12.010+3-3-HA05-HP358	31196672
13,99	14	124	77	60	45	SDR301G-13.990+3-3-HA05-HP358	31196676
14,00	14	124	77	60	45	SDR301G-14.000+3-3-HA05-HP358	31196677
14,01	14	124	77	60	45	SDR301G-14.010+3-3-HA05-HP358	31196678
15,99	16	133	83	63	48	SDR301G-15.990+3-3-HA05-HP358	31196682
16,00	16	133	83	63	48	SDR301G-16.000+3-3-HA05-HP358	31196683
16,01	16	133	83	63	48	SDR301G-16.010+3-3-HA05-HP358	31196684

Fortsetzung auf nächster Seite.

Tritan-Drill-Reamer | Bohrreibahle SDR301G (5xD), innere Kühlmittelzufuhr

Konfigurierbare Merkmale



Durchmesser:
Durchmesser in Abstufungen von 0,001 mm frei wählbar

Spezifikation:
SDR301G-[Durchmesser]+3-3-HA05-HP358

Beispiel:
SDR301G-04001+3-3-HA05-HP358

Werkzeughdurchmesser $d_1 = 4,001$ mm

Abmessungen konfigurierbare Baureihe

d ₁ min.	d ₁ max.	d ₂ h6	l ₁	l ₂	l ₃	l ₄
3,800	4,700	6	74	36	29	36
4,701	6,050	6	82	44	35	36
6,051	8,050	8	91	53	43	36
8,051	10,050	10	103	61	49	40
10,051	12,050	12	118	71	56	45
12,970	14,050	14	124	77	60	45
14,970	16,050	16	133	83	63	48
16,800	18,050	18	143	93	71	48
18,700	20,050	20	153	101	77	50

Maßangaben in mm.
Für Passungsbohrungen der Toleranzklassen bis max. IT7, bei ausreichender Maschinenstabilität und Kühlung.
Die Hilfe zur Berechnung des optimalen Nenndurchmessers für unterschiedliche Passungsbohrungen entnehmen Sie bitte dem Informationsfeld am Kapitelende.
Schnittwertempfehlung siehe Kapitelende.
Sonderausführungen und andere Beschichtungen auf Anfrage.

Tritan-Drill-Reamer

Bohrreibahle

SDR301 (5xD), innere Kühlmittelzufuhr

Ausführung:

Bohrerdurchmesser: 4,00 – 20,00 mm
 Bohrungstoleranz: \geq IT 7
 Schneidstoff: HP358
 Schneidenanzahl: 3
 Anzahl Führungsfasen: 6
 Spitzenwinkel: 140°
 Spiralwinkel: 30°

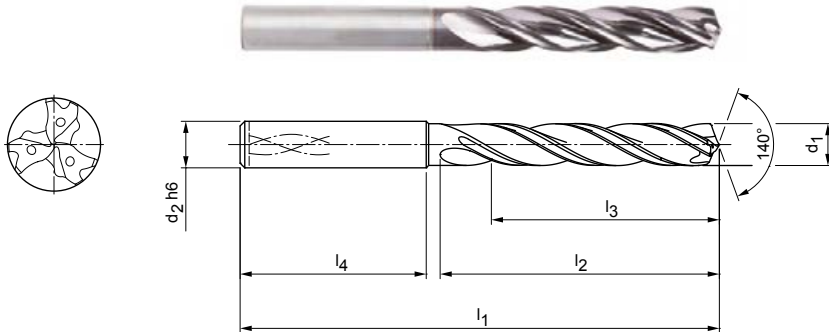

Lagerhaltige Vorzugsbaureihe in Schaftform HA

Baumaße						Schaftform HA	
d ₁ H7	d ₂ h6	l ₁	l ₂	l ₃	l ₄	Spezifikation	Bestell-Nr.
4,00	6	74	36	29	36	SDR301-4.000H7-HA05-HP358	31196627
5,00	6	82	44	35	36	SDR301-5.000H7-HA05-HP358	31196628
6,00	6	82	44	35	36	SDR301-6.000H7-HA05-HP358	31196629
8,00	8	91	53	43	36	SDR301-8.000H7-HA05-HP358	31196630
10,00	10	103	61	49	40	SDR301-10.000H7-HA05-HP358	31196631
12,00	12	118	71	56	45	SDR301-12.000H7-HA05-HP358	31196632
14,00	14	124	77	60	45	SDR301-14.000H7-HA05-HP358	31196633
16,00	16	133	83	63	48	SDR301-16.000H7-HA05-HP358	31196634
18,00	18	143	93	71	48	SDR301-18.000H7-HA05-HP358	31196635
20,00	20	153	101	77	50	SDR301-20.000H7-HA05-HP358	31196636

Maßangaben in mm.

Für Passungsbohrungen der Toleranzklasse H7, bei ausreichender Maschinenstabilität und Kühlung.

Schnittwertempfehlung siehe Kapitelende.

Sonderausführungen und andere Beschichtungen auf Anfrage.

Schnittwertempfehlung für Bohrreibahlen

Vorschub und Schnittgeschwindigkeit

Tritan-Drill-Reamer | SDR301

MZG*	Werkstoff	Festigkeit/Härte [N/mm ²] [HRC]
P	P1.1 Bau-, Automaten-, Einsatz- und Vergütungsstähle, unlegiert	< 700
	P1.2 Bau-, Automaten-, Einsatz- und Vergütungsstähle, unlegiert	< 1.200
	P2.1 Nitrier-, Einsatz- und Vergütungsstähle, legiert	< 900
	P2.2 Nitrier-, Einsatz- und Vergütungsstähle, legiert	< 1.400
	P3.1 Werkzeug-, Wälzlager-, Feder- und Schnellarbeitsstähle**	< 800
	P3.2 Werkzeug-, Wälzlager-, Feder- und Schnellarbeitsstähle**	< 1.000
	P3.3 Werkzeug-, Wälzlager-, Feder- und Schnellarbeitsstähle**	< 1.500
	P5.1 Stahlguss	
	K	K1.1 Gusseisen mit Lamellengraphit (Grauguss), GJL
K2.1 Gusseisen mit Kugelgraphit, GJS		< 500
K2.2 Gusseisen mit Kugelgraphit, GJS		≤ 800
K2.3 Gusseisen mit Kugelgraphit, GJS		> 800
K3.1 Gusseisen mit Vermiculargraphit, GJV; Temperguss, GJM		< 500
K3.2 Gusseisen mit Vermiculargraphit, GJV; Temperguss, GJM		> 500

BERECHNUNGSBEISPIEL

Bitte beachten Sie, dass das Ergebnis von zusätzlichen Parametern wie der Werkzeugmaschine oder der Werkzeugspannung beeinflusst werden kann.

Formel zur Berechnung des optimalen Werkzeugennendurchmessers:

$$(G_{oB} + G_{uB}) / 2$$

Beispiel:

- Passungsbohrung: ∅ 10 F7
- Höchstmaß Bohrung G_{oB} : 10,028 mm
- Mindestmaß Bohrung G_{uB} : 10,013 mm

$$\rightarrow (10,028 \text{ mm} + 10,013 \text{ mm}) / 2 = 10,021 \text{ mm} = \text{Auswahl Werkzeugennendurchmesser } 10,021 \text{ mm}$$

* MAPAL Zerspanungsgruppen

** Wenn die Legierungsbestandteile Cr, Mo, Ni, V, W in Summe > 8 %, dann die nächst höhere MAPAL Zerspanungsgruppe wählen.

	Schnittgeschwindigkeit v_c [m/min]				Vorschub f [mm] bei Bohrerdurchmesser					
	Innenkühlung	Außenkühlung	MMS	Luft	4,00	5,50	7,50	10,50	14,50	20,00
	70	65	65		0,17	0,22	0,27	0,34	0,41	0,47
	65	55	55		0,22	0,27	0,34	0,42	0,51	0,59
	70	60	60		0,20	0,26	0,32	0,40	0,48	0,56
	50	40	40		0,17	0,21	0,26	0,32	0,38	0,44
	55	45	45		0,18	0,23	0,29	0,36	0,43	0,50
	40	40	40		0,15	0,19	0,24	0,30	0,36	0,41
	40	30	35		0,13	0,16	0,19	0,23	0,28	0,32
	70	60	60		0,20	0,26	0,32	0,40	0,48	0,56
	100	70	70	70	0,25	0,33	0,42	0,55	0,67	0,79
	135	85	100	100	0,24	0,32	0,40	0,51	0,62	0,72
	85	65	65		0,22	0,28	0,35	0,44	0,54	0,62
	50	35	45		0,11	0,13	0,16	0,20	0,24	0,28
	75	70	70		0,23	0,30	0,38	0,47	0,58	0,67
	70	60	60		0,20	0,25	0,31	0,38	0,46	0,53

Die angegebenen Schnittwerte sind Richtwerte.

Die für den jeweiligen Bearbeitungsfall optimalen Daten sollten im Versuch oder während der Bearbeitung ermittelt werden.

SONDERLÖSUNGEN

Vollbohren mit Vollhartmetall



MAPAL bietet neben einem umfangreichen Standardprogramm an Bohrwerkzeugen auch Sonderwerkzeuge an.

Individuelle Kundenanforderungen verlangen nach Sonderlösungen, die speziell auf die Bearbeitungsaufgaben zugeschnitten sind. Mit dem großen Know-how in der Metallbearbeitung und der langjährigen Erfahrung ist MAPAL weltweit der kompetente Partner, wenn es um die Konstruktion und die Fertigung von Sonderwerkzeugen sowie die Auslegung von kompletten Zerspanungsprozessen für die Bohrungsbearbeitung geht. Das Programm umfasst spiralisierte und gerade genutete Bohrer sowie Stufenbohrer aus Vollhartmetall und PKD-bestückte Bohrer.

MAPAL – der Partner wenn es um anwendungsspezifische Sonderlösungen geht.



Sonderwerkzeuge zum Bohren von MAPAL

- 1 VHM-Sonder-Stufenbohrer mit drei Schneiden, selbstzentrierende Querschneide, für die Pleuelbearbeitung in einem Schuss
- 2 VHM-Stufenbohrer mit drei Führungsfasen und spezieller Beschichtung für die Hochgeschwindigkeitsbearbeitung
- 3 VHM-Kernlochbohrer für die Pleuelbearbeitung im zweistufigen Prozess
- 4 VHM-Stufenbohrer mit drei Führungsfasen und spezieller Beschichtung für die Hochgeschwindigkeitsbearbeitung von Achsschenkelgelenken aus ADI 900
- 5 VHM-Sonderbohrer mit Tritan-Drill-Geometrie und spezieller Beschichtung für die Turboladerbearbeitung
- 6 Bohrreibahle mit drei Schneiden und zusätzlichen Reibschneiden am Umfang mit spezieller Beschichtung für die Bearbeitung von Achsen aus GJS
- 7 VHM-Pilotbohrer für die Pleuelbearbeitung im zweistufigen Prozess
- 8 VHM-Tiefbohrer mit Sonderbeschichtung zur Bearbeitung von Zylinderblöcken aus GJV
- 9 VHM-Aluminiumbohrer mit drei Schneiden, selbstzentrierender Querschneide und hochglanzpolierten Spannuten für die Bearbeitung von AISi1
- 10 VHM-Stufenbohrer mit 180°-Stirnanschliff für die Ventilbearbeitung



SONDERLÖSUNGEN

Vollbohren mit PKD

Bei der Bearbeitung von Bauteilen aus Aluminium und anderen Nichteisen-Metallen kommen zum Bohren meist gerade genutete PKD-Bohrwerkzeuge zum Einsatz. Für die hohe Leistungsfähigkeit der PKD-Bohrer sind die Werkzeugmerkmale optimal aufeinander abgestimmt. Die Spannuten sind über die gesamte Länge des Bohrers poliert, um die Reibung der Späne möglichst gering zu halten. Die optimal eingebetteten PKD-Schneiden führen zu einem guten Schnittverhalten der Bohrer. Dadurch wird auch der Wärmeeintrag in das Bauteil reduziert.

Bei Prozessen mit Minimalmengenschmierung (MMS) hat MAPAL die Platzierung der Kühlmittelaustritte an den Werkzeugen angepasst, damit das Aerosol an genau den Stellen ankommt, wo es zur Schmierung benötigt wird. So wird das Risiko von Aufbauschneiden reduziert und die Standzeit des Bohrers verlängert.

Moderne Bearbeitungsprozesse erfordern jedoch zunehmend PKD-bestückte Bohrwerkzeuge mit einem großen Spiralwinkel.

Die spiralisierten PKD-Werkzeuge ermöglichen eine sichere und produktive Bohrungsbearbeitung. Spänestau oder Werkzeugbruch werden durch ein "mechanisch gefördertes" Abführen der Späne vermieden. Hochpositive Spanwinkel verringern die notwendigen Schnittkräfte. Mehrere Arbeitsgänge, wie Vollbohr- und Aufbohrprozess können in einem Arbeitsgang durchgeführt werden. Die Reduzierung der Bearbeitungszeit steigert Produktivität, bei hoher Prozesssicherheit und Bohrungsqualität.

Werkzeugfeatures im Detail



1 PKD-Schneiden

2 Spiralisierte und hochglanzpolierte Spannut

3 Optimierte Kühlmittelaustritte für MMS-Prozess

Optimal eingebettete PKD-Schneiden



Die optimale Einbettung von PKD-Segmenten in eine spiralisierte, allseits abgerundete Nut stellt hohe Ansprüche an die Produktionstechnik. Modernste Produktionsausstattung stellt sicher, dass spiralisierte PKD-Bohrwerkzeuge prozesssicher und reproduzierbar ausgelegt und gefertigt werden können. Um die Werkzeuge laufend zu verbessern, fließen über die technischen Berater und Produktspezialisten von MAPAL umfassende Anwendungsdetails mit in die Auslegung und in die Konstruktion ein.

Hochglanzpolierte Spannut



Die Spannuten sind hochglanzpoliert, sodass sich die entstehende Reibung durch Späne reduziert, und in der Konsequenz auch der Wärmeeintrag ins Bauteil sinkt. Die spiralisierte Ausführung der Spannuten ermöglicht ein „mechanisch gefördertes“ Abführen der Späne. Hochpositive Spanwinkel verringern die notwendigen Schnittkräfte.

Optimal für MMS-Prozesse



Die richtige Platzierung der Kühlmittelaustritte bei der MMS-Bearbeitung ist entscheidend für die Leistung des Bohrers. Das Aerosol muss an den Stellen ankommen, wo es zur Schmierung benötigt wird. So wird beispielsweise das Risiko von Aufbauschneiden reduziert und natürlich auch die Standzeit des Bohrers verlängert.



REIBEN UND FEINBOHREN

Höchste Genauigkeiten mit dem MAPAL Prinzip



PRODUKTÜBERSICHT

Reiben und Feinbohren

Werkzeuge zur Feinbearbeitung von Bohrungen stellen die Kernkompetenz von MAPAL dar. Mit der „Urreibahle“ im Jahr 1954 begann die Erfolgsgeschichte, die MAPAL bis heute in diesem Bereich schreibt. Die jahrzehntelange Erfahrung und kontinuierliche Weiterentwicklungen und Optimierungen der Werkzeuglösungen stellen sicher, dass MAPAL entsprechend der Komplexität der Bearbeitung und der Präzisionsanforderungen die passende Lösung bietet. Neben maßgeschneiderten Sonderlösungen steht dabei ein vielfältiges Standardprogramm an Werkzeugen zum Reiben und Feinbohren zur Verfügung.

Reiben und Feinbohren sind die gebräuchlichsten Verfahren zum Feinbearbeiten von Boh-

rungen und überzeugen durch präziseste Ergebnisse. Denn die gleiche Präzision, die die MAPAL Werkzeuge in der Praxis liefern, legt MAPAL der Fertigung der Werkzeuge zugrunde. Je nach Komplexität der Bearbeitung und den Anforderungen an Präzision und Oberfläche bietet MAPAL die passende Lösung:

Für höchste Präzision stehen Einschnidenreibahlen, Feinbohrwerkzeuge mit Führungsleisten und WP-Schneiden. Zudem umfasst das Programm Feste Mehrschneidenreibahlen: HPR-Wechselkopfreibahlen mit hochgenauem Spannsystem, Hochleistungsreibahlen aus Hartmetall oder Cermet sowie Systeme für die Bearbeitung großer Durchmesser.



Basic
LINE

Basic Line:
Universalwerkzeuge, breites Anwendungsgebiet, niedrige Anschaffungskosten

Performance
LINE

Performance Line:
Hochleistungswerkzeuge, breites Anwendungsgebiet, hohe Produktivität in der Serienfertigung

Expert
LINE

Expert Line:
Spezialistenwerkzeuge für ausgewählte Anwendungen, maximale Präzision und Produktivität

Feste Mehrschneidenreibahlen



Hochleistungsreibahle | FXR

Die Hochleistungsreibahlen der FXR-Reihe - die Mittel der Wahl wenn kurze Taktzeiten gefragt sind - sind mit unterschiedlichen Schneidstoffen und Beschichtungen verfügbar. So können nahezu sämtliche Werkstoffe mit ihnen wirtschaftlich und prozesssicher bearbeitet werden. Ohne jeglichen Einstellaufwand erreichen die Werkzeuge, die im Durchmesserbereich 2,800 bis 20,200 mm erhältlich sind, IT7-Toleranzen.

Ø-Bereich: 2,800 - 20,200 mm*



Bestückte Hochleistungsreibahlen | MOR/MRP

Einfach, leistungsfähig und standardisiert - so lässt sich das Reibsystem der Mono-Ream-Baureihe zusammenfassen. Die Schneiden der Hochleistungsreibahlen der FXR-Reihe sind auf den Grundkörper aufgelötet. Die MOR-Reibahlen können - im Gegensatz zu den FXR-Reibahlen - wiederaufbereitet werden. Dafür sind sie mit einer Dehnschraube versehen, die die Reibahle im Durchmesser aufweitet und so ein Nachschleifen ermöglicht.

Ø-Bereich: 3,850 - 40,200 mm*



HPR-Wechselkopfreibahle mit HFS-Trennstelle

Ist ein Höchstmaß an Wirtschaftlichkeit gefragt, empfiehlt sich im kleinen Durchmesserbereich der Einsatz der HPR-Wechselkopfreibahlen. Durch die hochpräzise Trennstelle HFS sind - trotz Wechselkopfsystem - ein exakter Rundlauf sowie eine hohe Wechselgenauigkeit garantiert. Dabei ist das Handling denkbar einfach. Die HPR-Reibahlen sind mit fest gelöteten Schneiden sowie mit justierbaren Schneiden verfügbar.

Ø-Bereich: 7,000 - 65,000 mm*



Werkzeuge mit Führungsleisten



Einschnidenreibahle

Für größtmögliche Präzision sind Einschnidenreibahlen mit Führungsleisten nach dem MAPAL Prinzip nahezu konkurrenzlos. Ihre Schneidplatten sind mit zwei Schneidkanten und speziellen Anschnitten erhältlich.

Ø-Bereich: 5,000 - 30,290 mm*



* Der Durchmesserbereich kann je nach Baureihe variieren.



Lösungen für große Durchmesser

Sonderlösungen



EasyAdjust-System

Die drastische Reduzierung des Einstellaufwandes bei Werkzeugen mit Führungsleistentechnologie war das Ziel bei der Entwicklung des EasyAdjust-Systems. Im Mittelpunkt des Systems steht eine innovative Kassette, die die sechs- bzw. vierschneidigen Wendschneidplatten spielfrei und stabil aufnimmt. Die Verjüngung der Nebenschneide ist bereits in die Kassette integriert, somit entfällt dieser Einstellaufwand. Durch die exakte Führung der Kassette auf einem Präzisionsführungsstift bleibt die Verjüngung auch während der DurchmesserEinstellung unverändert.

Ø-Bereich: ab 20,000 mm*

P M K N S H

Lösungen für große Durchmesser

Mehrschneidige Hochleistungsreibahlen für große Durchmesserbereiche. HPR400 – schnelles Wechseln der Schneiden vor Ort ohne lange Wiederaufbereitung. HPR400 plus – vier statt bisher einer Schneidkante. Einfaches Wenden und Wechseln der Schneidplatten.

Ø-Bereich: 63,000 – 319,999 mm*

P M K N H

Sonderwerkzeuge nach Maß

Spezielle Bearbeitungsaufgaben erfordern besondere Werkzeuge. Deshalb bietet MAPAL Reibwerkzeuge in Sonderausführungen, die individuell auf die Anforderungen des Kunden zugeschnitten sind. Mit speziellen Anschnittgeometrien und Beschichtungen sowie Stufenwerkzeugen werden die jeweiligen Aufgaben optimal erfüllt. Kombinationslösungen mit weiteren Werkzeugtechnologien von MAPAL können zusätzlich die Produktivität steigern und Nebenzeiten reduzieren.

AUSWAHLSYSTEM

Feste Mehrschneidenreibahlen | Werkzeuge mit Führungsleisten

Feste Mehrschneidenreibahlen

Erste Wahl für folgende Anwendungen:

- Bearbeitung mit hohen Vorschubgeschwindigkeiten
- Höchste Ausbringung in der Serienproduktion
- Abrasive und harte Werkstoffe
- Mehrspindelbearbeitungen
- Bearbeitungen im Durchmesser < 5 mm



Werkzeuge mit Führungsleisten

Erste Wahl für folgende Anwendungen:

- Instabile Maschinenverhältnisse
- Optimal mit Pendelhalter auf der Drehmaschine
- Stegbearbeitungen und dünnwandige Bauteile
- Ungünstige Längen- und Durchmesserhältnisse
- Extrem hohe Form- und Lagetoleranzen





WERKZEUGEIGENSCHAFTEN

- Feste Ausführungen ohne Einstellaufwand
- Feinjustierbare Ausführungen optimiert zum Nachschleifen
- Hochgenaue Wechselkopfsysteme mit einfachem Handling
- Unterschiedliche Leistungsklassen im Standardprogramm
- Wiederaufbereitung für hohe Wirtschaftlichkeit
- Vorzugsbaureihe ab Lager lieferbar, Zwischenabmessung kurzfristig lieferbar

Mit festen mehrschneidigen Reibahlen sind drastisch reduzierte Bearbeitungszeiten möglich. Die Mehrschneidigkeit erlaubt vielfach höhere Vorschubwerte, was letztendlich die Bearbeitungszeiten bestimmt. Durch

spezifisch entwickelte Systeme und modernste Fertigungstechnologie bietet MAPAL auch bei diesen Werkzeugen höchste Genauigkeiten.

► [Mehr ab Seite 311](#)



WERKZEUGEIGENSCHAFTEN

- Höchste Genauigkeiten durch exaktes und μ -genaues Einstellen
- Wendelplattentechnik für höchste Flexibilität bei der Schneidstoffwahl
- Zwischenabmessungen und alle Toleranzen kurzfristig lieferbar

Die MAPAL Führungsleistentechnologie ist unerreicht bezüglich der Feinbearbeitung von Bohrungen in jeglichen Konstruktionswerkstoffen. Die Genauigkeiten des Bohrungsdurchmessers, der Rundheit und Zylinderform, als

auch der Oberflächengüte, sind mit anderen Fertigungsmitteln nicht herstellbar oder zumindest nicht wirtschaftlich zu erreichen.

► [Mehr ab Seite 477](#)



FESTE MEHR- SCHNEIDENREIBBAHLEN

Feste Mehrschneidenreibbahlen

Auswahlhilfe	312
--------------------	-----

FixReam FXR

Produktübersicht	316
Auswahlübersicht FXR	318
FXR510	322
FXR500	330
FXR505	332
FXR503-short	342
Schnittwertempfehlung	344

MonoReam MOR

Produktübersicht	350
Auswahlübersicht MOR/MRP	352
MOR710	356
MOR700	358
MOR705	359
MRP510	362
MRP505	363
Schnittwertempfehlung	364

Wechselkopfreibbahlen HPR

Produktübersicht	368
Auswahlübersicht HPR	370
HPR130	374
HPR131	379
HPR100	383
HPR110	390
HPR180	396
HPR150	405
HPR230	414
HPR231	418
HPR200	422
HPR210	426
HPR280	430
HPR250	438
Schnittwertempfehlung	446
Aufmaße beim Reiben	458
Halterprogramm HFS	460
Ersatzteile und Zubehör	474



AUSWAHL MEHRSCHEIDENREIBAHLEN

Schritt für Schritt zur richtigen Reibahle

Sie suchen zum Beispiel eine VHM Mehrschneidenreibahle im Durchmesser 10,000H7 für die Bearbeitung einer Grundbohrung in Stahl? Diese Auswahlhilfe führt Sie Schritt für Schritt zur richtigen Reibahle.

1	Design	Wählen Sie Ihr bevorzugtes Design (monolithisch oder modular).		Monolithisch		Modular Trennstelle HFS
2	Bohrungsmerkmale	Überprüfen Sie, ob die Geometriemerkmale Ihren Anforderungen entsprechen. Wählen Sie den Durchmesserbereich und die erforderliche Toleranz.		Durchmesserbereich		Erreichbare Bohrungs-toleranz \geq IT7
3	Produktklasse	Entscheiden Sie sich für eine Produktklasse.		Basic Line: Universalwerkzeuge, breites Anwendungsgebiet, niedrige Anschaffungskosten		
4	Materialeignung	Bestimmen Sie Ihren Werkstückstoff gemäß den MZG (MAPAL Zerspanungsgruppen).		Stahl		Rostfreier Stahl
5	Bohrungsart	Prüfen Sie die Anforderungen, die durch die Bohrungsart an Ihr Werkzeug gestellt werden.		Durchgangsbohrung		Grundbohrung
6	Produkt	Wählen Sie Ihre Reibahle. Produkte der lagerhaltigen Vorzugsbaureihe sind kurzfristig lieferbar während Produkte mit konfigurierbaren Merkmalen innerhalb vorgegebener Grenzen frei konfiguriert werden können.		Lagerhaltige Vorzugsbaureihe		Freie Konfiguration





Performance Line:
Hochleistungswerkzeuge, breites Anwendungsgebiet, hohe Produktivität in der Serienfertigung



Expert Line:
Spezialistenwerkzeuge für ausgewählte Anwendungen, maximale Präzision und Produktivität



Gusseisen



Nichteisenmetalle und Kunststoffe

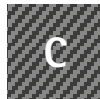

Verbundwerkstoffe



Superlegierungen und Titan



Gehärteter Stahl und Stahlguss





Reibahle | Auswahlssystem

Design	Empfohlener Durchmesserbereich [mm]	Toleranz	Baureihe			Produktklasse	
				Durchmesser	Serie		
	3,000 - 14,000	≥ IT6	FixReam	<p>Vollhartmetallreibahle für einen breiten Anwendungsbereich. Je nach Durchmesser haben die Hochleistungsreibahlen FixReam zwischen vier und acht Schneiden mit Innenkühlung und erreichen dadurch entsprechend hohe Vorschubgeschwindigkeiten.</p>	2,800 - 20,200*	FXR510	Performance LINE
					2,800 - 20,200*	FXR505	
					3,701 - 20,200*	FXR500	
					2,800 - 20,100*	FXR503	
	14,000 - 40,000	≥ IT6	MonoReam	<p>Die MOR700 wird als festes Werkzeug eingesetzt, jedoch ist diese Baureihe für das Nachschleifen optimiert. Durch eine einteilige Dehnschraube wird die Reibahle im Durchmesser aufgeweitet.</p>	7,700 - 40,200	MOR700	Performance LINE
						MOR705	
						MOR710	
	4,000 - 8,000	≥ IT6	MonoReam Plus	<p>Speziell für die Bearbeitung von Guss und Stahl. Eine Hülse sichert die optimale Kühlmittelversorgung der HPC-Schneiden.</p>	3,850 - 8,200	MRP505	Performance LINE
						MRP510	
	7,000 - 65,000	≥ IT5	HPR	<p>Hochgenaues Wechselkopf-System in fester und feinjustierbarer Ausführung.</p>	7,000 - 65,000	HPR1XX fest	Performance LINE
						7,000 - 65,000	
	63,000 - 319,999	≥ IT7	HPR 400 400 plus	<p>Durch wechselbare Schneiden kann vor Ort einfach die Schneide erneuert werden. Somit entstehen sehr kurze Rüstzeiten.</p>	63,000 - 319,999	HPR400 400 plus	Expert LINE

* Der Durchmesserbereich kann je nach Baureihe variieren.

Schritt 1:
Design



Schritt 2:
Bohrungsmerkmale



Schritt 3:
Produktklasse



Schritt 4:
Materialeignung



Schritt 5:
Bohrungsart

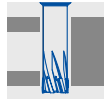

	Materialeignung														Bohrungsart				Produkt										
	P						M	K					N		C			S	H		Drehbohrung	Reiben	Durchmesserbereich (konfigurierbar)	Seite					
	1	2	3.1	3.2	3.3	4	5	6	1-3	1	2.1	2.2	2.3	3	1-2	N3	1.1	1.2	1.3	1-5					1	2			
	■	■	■	■	■	■	■	■	■	■	■	■	■	■	■		■	■	■	■			■		2,800-20,200*	316			
	■	■	■	■	■	■	■	■	■	■	■	■	■	■		■	■	■	■	■	■	■	■						
								■						■						■	■	■	■						
	■	■	■	■	■	■	■	■	■	■	■	■	■											■			■		
								■						■	■									■	■	7,700-40,200	350		
	■	■	■	■	■	■	■	■	■	■	■	■	■	■	■									■	■				
	■	■	■	■	■	■	■	■	■	■	■	■	■											■	■				
	■	■	■	■				■	■	■														■	■	3,850-8,200	350		
	■	■	■	■				■	■	■														■	■				
	■	■	■	■	■	■	■	■	■	■	■	■	■	■					■					■	■	7,000-65,000	368		
	■	■	■	■	■	■	■	■	■	■	■	■	■	■					■					■	■				
	■	■	■	■	■	■	■	■	■	■	■	■	■	■										■	■	63,000-319,999	562		

PRODUKTÜBERSICHT

FixReam: FXR500 | FXR510 | FXR505 | FXR503

Die Baureihen der Hochleistungsreibahlen FXR aus Vollhartmetall decken einen breiten Anwendungsbereich ab. Je nach Durchmesser haben die Hochleistungsreibahlen FixReam zwischen vier bis acht Schneiden mit Innenkühlung und erreichen dadurch entsprechend hohe Vorschubgeschwindigkeiten. Dank unterschiedlicher Schneidstoffe und Beschichtungen können zahlreiche Werkstoffe wirtschaftlich und prozesssicher im Durchmesserbereich 2,850 bis 20,200 mm* ohne Justiervorgang im Toleranzbereich IT7 bearbeitet werden.

Für den Einsatz bei begrenzten Platzverhältnissen, beispielsweise auf Drehautomaten, stehen die kurzen „Short“-Ausführungen zur Verfügung.



FixReam



FixReam | FXR500 Vollhartmetall

Hochleistungsreibahlen gerade genutet mit Innenkühlung aus Vollhartmetall. Als Vorzugsbaureihe in H7.

Vorzugsbaureihe ϕ -Bereich: 3,701 - 20,200 mm*



FixReam | FXR510 Vollhartmetall

Hochleistungsreibahlen linksschräg genutet mit Innenkühlung aus Vollhartmetall. Als Vorzugsbaureihe in H7.

Vorzugsbaureihe ϕ -Bereich: 2,800 - 20,200 mm*





FixReam | FXR505 Vollhartmetall

Hochleistungsreibahlen gerade genutet mit Innenkühlung aus Vollhartmetall. Als Vorzugsbaureihe in H7.

Vorzugsbaureihe ϕ -Bereich: 2,800 - 20,200 mm*

Perfor-
mance
LINE



P M K N C S H



FixReam | FXR503-short Vollhartmetall

Extra kurze Hochleistungsreibahle aus Vollhartmetall, die speziell für den Einsatz auf Drehautomaten ausgelegt ist. Als Vorzugsbaureihe in H7.

Vorzugsbaureihe ϕ -Bereich: 2,800 - 20,100 mm*

Perfor-
mance
LINE



P K

Auswahlübersicht FixReam (1/2)

Pro- dukt- klasse	Bohrungsart	Materialeignung													
		P				M	K	N			C	S	H		
		1-3	4	5	6	1-3	1-3	1	2	4	1	1-5	1	2	
Performance LINE		■	■	■	■		■								
			■		■										
								■							
								■	■	■					
											■				
												■			
													■		
														■	■
		■	■	■	■		■								
		■	■	■	■		■								
			■		■										
									■						
									■	■	■				
												■			

Bestellbeispiel:

Baureihe

Durchmesser

Toleranz



FixReam

Ausführungen:
Vollhartmetall

Bohrungsart:
0 | 2 = Durchgangs-
bohrung
3 | 5 = Grund-
bohrung







Schrägungswinkel der Schneiden:
0 = Gerade genutet
1 = Linksschräg genutet

Angabe
Werkzeugschleifdurchmesser
(Stelle wird nur bei G-Variante belegt)

Bohrungsdurchmesser

IT oder Abmaße in µm
(Beispiel: +30+10)
oder bei G-Variante
Angabe der Fertigungs-
toleranz des Werkzeug-
schleifdurchmessers
zum Beispiel -3µm

Schritt 1:
ProduktklasseSchritt 2:
BohrungsartSchritt 3:
MaterialeignungSchritt 4:
AusführungSchritt 5:
Vorkonfigurierte Durchmesser oder Konfiguration

	Ausführung					Vorkonfigurierte Durchmesser		Konfiguration
	d1	Schneidstoff	Anschnitt			Baureihe	Seite	
	2,800-20,200	HP145	MG1M	■		FXR510	322	FXR510 Feste Ausführung, linksschräg genutet, für Durchgangsbohrung 
	3,701-20,200	HP145	MF1M	■		FXR510	326	
	3,701-20,200	HP622	MG0A		■	FXR500	330	
	2,800-20,200	HU612	MG1M	■		FXR510	324	FXR500 Feste Ausführung, gerade genutet, für Durchgangsbohrung 
	3,701-20,200	HC614	MF1M	■		FXR510	329	
	3,701-20,200	HP625	MF1M	■		FXR510	328	
	3,701-20,200	HP141	MFOA		■	FXR500	331	
	2,800-20,200	HP145	MV0A		■	FXR505	332	
	2,800-20,100	HP145	MC1F		■	FXR503	342	FXR505 Feste Ausführung, gerade genutet, für Grundbohrung 
	3,701-20,200	HP145	MT0A		■	FXR505	334	
	3,701-20,200	HP622	MV0A		■	FXR505	335	
	2,800-20,200	HU612	MV0A		■	FXR505	336	
	3,701-20,200	HC614	MV0A		■	FXR505	339	
	3,701-20,200	HP625	MT0A		■	FXR505	338	
	3,701-20,200	HP141	MT0A		■	FXR505	340	FXR503-short Feste Ausführung, gerade genutet, für Grundbohrung 

Baureihenkonfiguration auf nächster Seite.

Anschnitt [Lead]

Schneidstoff [Cut]

M	G	O	A	-	H	P	6	2	2
---	---	---	---	---	---	---	---	---	---

Anschnittform und

Spanwinkel:

MG0A	MT0A	Erklärung der Anschnittgeometrien siehe Seiten 752
MG1M	MFOA	
MF1M	MC1F	
MV0A		

Schneidstoff:

HP145	HP141
HU612	HP625
HP622	
HC614	

Auswahlübersicht FixReam | Konfiguration (2/2)

FXR510

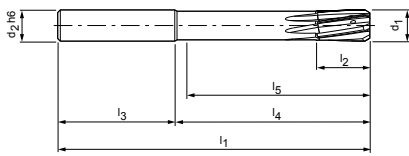

FXR500

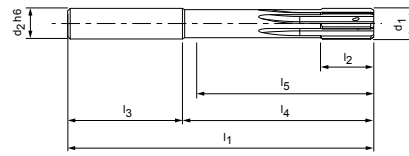

FXR505

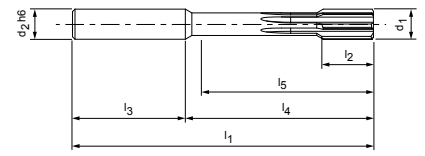

Werkzeugabmessungen

FXR510

d ₁	d ₂	l ₁	l ₂	l ₃	l ₄	l ₅	z
2,800 - 3,700	4	65	12	28	37	34	4
3,701 - 4,700	6	75	12	36	39	34	4
4,701 - 6,200	6	75	12	36	39	35	4
6,201 - 7,200	8	100	16	36	64	59	6
7,201 - 8,200	8	100	16	36	64	60	6
8,201 - 9,200	10	100	20	40	60	55	6
9,201 - 10,200	10	120	20	40	80	76	6
10,201 - 11,200	12	120	20	45	75	70	6
11,201 - 12,200	12	120	20	45	75	71	6
12,201 - 14,200	14	130	22	45	85	80	6
14,201 - 15,200	16	130	22	48	82	77	6
15,201 - 16,200	16	150	25	48	102	97	6
16,201 - 18,200	18	150	25	48	102	97	8
18,201 - 20,200	20	150	25	50	100	95	8

FXR505

d ₁	d ₂	l ₁	l ₂	l ₃	l ₄	l ₅	z
2,800 - 3,350	4	65	12	37	28	33	4
3,351 - 3,700	4	65	12	28	37	33	4
3,701 - 6,200	6	75	12	36	39	34	4
6,201 - 8,200	8	100	16	36	64	58	6
8,201 - 9,200	10	100	20	40	60	54	6
9,201 - 10,200	10	120	20	40	80	74	6
10,201 - 12,200	12	120	20	45	75	68	6
12,201 - 14,200	14	130	22	45	85	78	6
14,201 - 15,200	16	130	22	48	82	75	6
15,201 - 16,200	16	150	25	48	102	95	6
16,201 - 18,200	18	150	25	48	102	95	6
18,201 - 20,200	20	150	25	50	100	92	6

Toleranzen für die G-Variante/feste Variante FXR5XX:

Schneidstoff	Durchmesserbereich
	Ø2,800 - 20,200
Unbeschichtet	-0,003
HU612	
Beschichtet (Schichtdicke 0,8 - 2 µm)	-0,004
HP145	
HP625	
HP622	
HC614	
Beschichtet (Schichtdicke 2 - 4 µm)	-0,005
HP141	

Erklärung G-Variante FXR

Zulässige Werkstücktoleranzen zur Auswahl des Werkzeugdurchmessers

Ausführung G-Variante:

Die G-Variante gibt den Werkzeugdurchmesser der Reibahle mit unseren Fertigungstoleranzen an. Die Fertigungstoleranzen sind vom Schneidstoff abhängig, siehe zulässige kleinste Toleranzen für die G-Variante.

FXR503-short

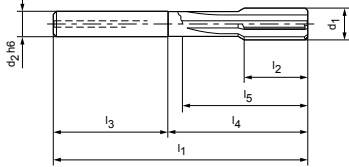

FXR500

d_1	d_2	l_1	l_2	l_3	l_4	l_5	z
3,701 - 4,700	6	75	12	36	39	34	4
4,701 - 6,200	6	75	12	36	39	35	4
6,201 - 7,200	8	100	16	36	64	59	6
7,201 - 8,200	8	100	16	36	64	60	6
8,201 - 9,200	10	100	20	40	60	55	6
9,201 - 10,200	10	120	20	40	80	76	6
10,201 - 11,200	12	120	20	45	75	70	6
11,201 - 12,200	12	120	20	45	75	71	6
12,201 - 14,200	14	130	22	45	85	80	6
14,201 - 15,200	16	130	22	48	82	77	6
15,201 - 16,200	16	150	25	48	102	97	6
16,201 - 18,200	18	150	25	48	102	97	8
18,201 - 20,200	20	150	25	50	100	95	8

FXR503-short

d_1	d_2	l_1	l_2	l_3	l_4	l_5	z
2,800 - 4,050	4	56	12	28	28	24	4
4,051 - 5,100	6	64	12	36	28	23	4
5,101 - 5,600	6	64	12	36	28	24	4
6,101 - 6,600	8	75	16	36	39	32	6
6,601 - 7,100	8	75	16	36	39	34	6
7,101 - 8,100	8	75	16	36	39	35	6
8,101 - 10,100	8	75	20	36	39	35	6
10,101 - 11,600	10	80	20	40	40	35	6
11,601 - 13,100	12	90	22	45	45	40	6
13,101 - 15,100	14	90	22	45	45	40	6
15,101 - 18,100	16	100	25	48	52	47	8
18,101 - 20,100	18	100	25	48	52	47	8



Kundenspezifische Sonderlösungen
zur mehrstufigen Bearbeitung.

FixReam

Feste Ausführung, linksschräg genutet, für Durchgangsbohrung
FXR510

Ausführung:

Reibahldurchmesser: 2,800 - 20,200 mm
 Anschnitt: MG1M
 Schneidstoff: HP145
 Hartmetall
 PVD-beschichtet

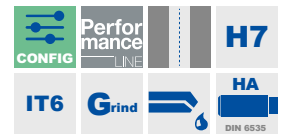
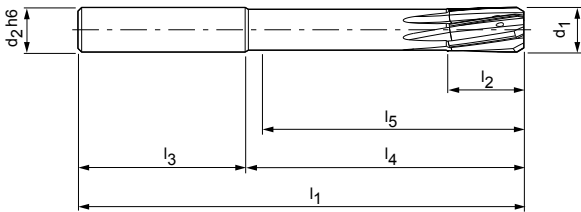

Lagerhaltige Vorzugsbaureihe in H7

d ₁ H7	Baumaße						z	Spezifikation	Bestell-Nr.
	d ₂ h6	l ₁	l ₂	l ₃	l ₄	l ₅			
4,000	6	75	12	36	39	34	4	FXR510Ø4.000H7MG1M-HP145	30570722
5,000	6	75	12	36	39	35	4	FXR510Ø5.000H7MG1M-HP145	30570724
6,000	6	75	12	36	39	35	4	FXR510Ø6.000H7MG1M-HP145	30570726
7,000	8	100	16	36	64	59	6	FXR510Ø7.000H7MG1M-HP145	30570728
8,000	8	100	16	36	64	60	6	FXR510Ø8.000H7MG1M-HP145	30570730
9,000	10	100	20	40	60	55	6	FXR510Ø9.000H7MG1M-HP145	30570732
10,000	10	120	20	40	80	76	6	FXR510Ø10.000H7MG1M-HP145	30570734
11,000	12	120	20	45	75	70	6	FXR510Ø11.000H7MG1M-HP145	30570736
12,000	12	120	20	45	75	71	6	FXR510Ø12.000H7MG1M-HP145	30570738
13,000	14	130	22	45	85	80	6	FXR510Ø13.000H7MG1M-HP145	30570739
14,000	14	130	22	45	85	80	6	FXR510Ø14.000H7MG1M-HP145	30570740
15,000	16	130	22	48	82	77	6	FXR510Ø15.000H7MG1M-HP145	30570741
16,000	16	150	25	48	102	97	6	FXR510Ø16.000H7MG1M-HP145	30570742
17,000	18	150	25	48	102	97	8	FXR510Ø17.000H7MG1M-HP145	30570743
18,000	18	150	25	48	102	97	8	FXR510Ø18.000H7MG1M-HP145	30570744
19,000	20	150	25	50	100	95	8	FXR510Ø19.000H7MG1M-HP145	30570745

Maßangaben in mm.
Schnittwertempfehlung siehe Kapitelende.

FXR510 | Feste Ausführung, linksschräg genutet

Konfigurierbare Merkmale

**Bohrungsdurchmesser Toleranz \geq IT6:**

- Durchmesser in Abstufungen von 0,001 mm frei wählbar
- In Toleranz \geq IT6 bestellbar

**Spezifikation:**

FXR510Ø[Durchmesser][Toleranz]MG1M-HP145

G-Variante:

- Durchmesser in Abstufungen von 0,001 mm frei wählbar
- Ab Toleranz \geq 4 μ m bestellbar (G-Variante siehe Seite 320)

Spezifikation G-Variante:

FXR510GØ[Durchmesser][Toleranz]MG1M-HP145

Abmessungen konfigurierbare Baureihe IT6

d_1	d_2	l_1	l_2	l_3	l_4	l_5	z
2,800 - 3,700	4	65	12	28	37	34	4
3,701 - 4,700	6	75	12	36	39	34	4
4,701 - 6,200	6	75	12	36	39	35	4
6,201 - 7,200	8	100	16	36	64	59	6
7,201 - 8,200	8	100	16	36	64	60	6
8,201 - 9,200	10	100	20	40	60	55	6
9,201 - 10,200	10	120	20	40	80	76	6
10,201 - 11,200	12	120	20	45	75	70	6
11,201 - 12,200	12	120	20	45	75	71	6
12,201 - 14,200	14	130	22	45	85	80	6
14,201 - 15,200	16	130	22	48	82	77	6
15,201 - 16,200	16	150	25	48	102	97	6
16,201 - 18,200	18	150	25	48	102	97	8
18,201 - 20,200	20	150	25	50	100	95	8

Beispiel Toleranz IT6:

FXR510Ø16.350H6MG1M-HP145

Bohrungsdurchmesser $d_1 = 16,350$ H6**Beispiel G-Variante:**

FXR510GØ16.350-4MG1M-HP145

Spezieller Werkzeugdurchmesser $d_1 = 16,350 -4 \mu$ m

FixReam

Feste Ausführung, linksschräg genutet, für Durchgangsbohrung
FXR510

Ausführung:

Reibahldurchmesser: 2,800 - 20,200 mm
 Anschnitt: MG1M
 Schneidstoff: HU612
 Hartmetall
 unbeschichtet

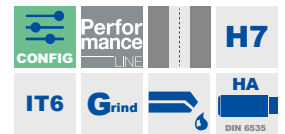
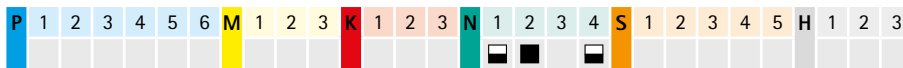
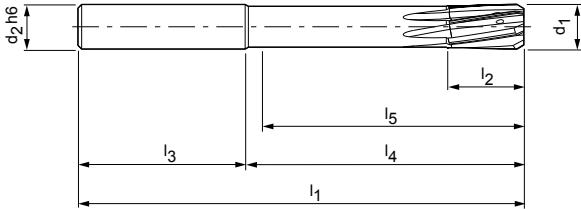

Lagerhaltige Vorzugsbaureihe in H7

d ₁ H7	Baumaße						z	Spezifikation	Bestell-Nr.
	d ₂ h6	l ₁	l ₂	l ₃	l ₄	l ₅			
4,000	6	75	12	36	39	34	4	FXR510Ø4.000H7MG1M-HU612	30570665
5,000	6	75	12	36	39	35	4	FXR510Ø5.000H7MG1M-HU612	30570667
6,000	6	75	12	36	39	35	4	FXR510Ø6.000H7MG1M-HU612	30570669
7,000	8	100	16	36	64	59	6	FXR510Ø7.000H7MG1M-HU612	30570671
8,000	8	100	16	36	64	60	6	FXR510Ø8.000H7MG1M-HU612	30570673
9,000	10	100	20	40	60	55	6	FXR510Ø9.000H7MG1M-HU612	30570675
10,000	10	120	20	40	80	76	6	FXR510Ø10.000H7MG1M-HU612	30570677
11,000	12	120	20	45	75	70	6	FXR510Ø11.000H7MG1M-HU612	30570679
12,000	12	120	20	45	75	71	6	FXR510Ø12.000H7MG1M-HU612	30570682
13,000	14	130	22	45	85	80	6	FXR510Ø13.000H7MG1M-HU612	30570683
14,000	14	130	22	45	85	80	6	FXR510Ø14.000H7MG1M-HU612	30570684
15,000	16	130	22	48	82	77	6	FXR510Ø15.000H7MG1M-HU612	30570685
16,000	16	150	25	48	102	97	6	FXR510Ø16.000H7MG1M-HU612	30570686
17,000	18	150	25	48	102	97	8	FXR510Ø17.000H7MG1M-HU612	30570687
18,000	18	150	25	48	102	97	8	FXR510Ø18.000H7MG1M-HU612	30570688

Maßangaben in mm.
 Schnittwertempfehlung siehe Kapitelende.

FXR510 | Feste Ausführung, linksschräg genutet

Konfigurierbare Merkmale

**Bohrungsdurchmesser Toleranz \geq IT6:**

- Durchmesser in Abstufungen von 0,001 mm frei wählbar
- In Toleranz \geq IT6 bestellbar

**Spezifikation:**

FXR510Ø[Durchmesser][Toleranz]MG1M-HU612

G-Variante:

- Durchmesser in Abstufungen von 0,001 mm frei wählbar
- Ab Toleranz \geq 3 μ m bestellbar (G-Variante siehe Seite 320)

Spezifikation G-Variante:

FXR510GØ[Durchmesser][Toleranz]MG1M-HU612

Abmessungen konfigurierbare Baureihe IT6

d ₁	d ₂	l ₁	l ₂	l ₃	l ₄	l ₅	z
2,800 - 3,700	4	65	12	28	37	34	4
3,701 - 4,700	6	75	12	36	39	34	4
4,701 - 6,200	6	75	12	36	39	35	4
6,201 - 7,200	8	100	16	36	64	59	6
7,201 - 8,200	8	100	16	36	64	60	6
8,201 - 9,200	10	100	20	40	60	55	6
9,201 - 10,200	10	120	20	40	80	76	6
10,201 - 11,200	12	120	20	45	75	70	6
11,201 - 12,200	12	120	20	45	75	71	6
12,201 - 14,200	14	130	22	45	85	80	6
14,201 - 15,200	16	130	22	48	82	77	6
15,201 - 16,200	16	150	25	48	102	97	6
16,201 - 18,200	18	150	25	48	102	97	8
18,201 - 20,200	20	150	25	50	100	95	8

Beispiel Toleranz IT6:

FXR510Ø16.350H6MG1M-HU612

Bohrungsdurchmesser d₁ = 16,350 H6**Beispiel G-Variante:**

FXR510GØ16.350-3MG1M-HU612

Spezieller Werkzeugdurchmesser d₁ = 16,350 -3 μ m

FixReam

Feste Ausführung, linksschräg genutet, für Durchgangsbohrung
FXR510

Ausführung:

Reibahldurchmesser: 3,701 - 20,200 mm
Anschnitt: MF1M
Schneidstoff: HP145
Hartmetall
PVD-beschichtet

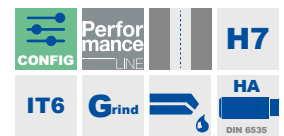
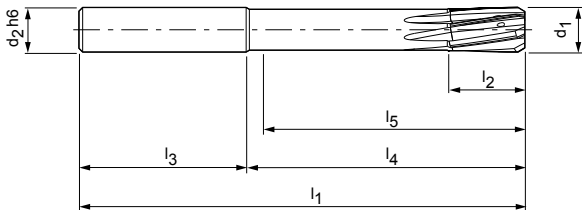

Lagerhaltige Vorzugsbaureihe in H7

d ₁ H7	Baumaße						z	Spezifikation	Bestell-Nr.
	d ₂ h6	l ₁	l ₂	l ₃	l ₄	l ₅			
4,000	6	75	12	36	39	35	4	FXR510Ø4.000H7MF1M-HP145	30570772
5,000	6	75	12	36	39	35	4	FXR510Ø5.000H7MF1M-HP145	30570774
6,000	6	75	12	36	39	35	4	FXR510Ø6.000H7MF1M-HP145	30570776
7,000	8	100	16	36	64	59	6	FXR510Ø7.000H7MF1M-HP145	30570778
8,000	8	100	16	36	64	60	6	FXR510Ø8.000H7MF1M-HP145	30570780
10,000	10	120	20	40	80	76	6	FXR510Ø10.000H7MF1M-HP145	30570784
11,000	12	120	20	45	75	70	6	FXR510Ø11.000H7MF1M-HP145	30570786
12,000	12	120	20	45	75	71	6	FXR510Ø12.000H7MF1M-HP145	30570788
14,000	14	130	22	45	85	80	6	FXR510Ø14.000H7MF1M-HP145	30570790
16,000	16	150	25	48	102	97	6	FXR510Ø16.000H7MF1M-HP145	30570792

Maßangaben in mm.

Schnittwertempfehlung siehe Kapitelende.

FXR510 | Feste Ausführung, linksschräg genutet

Konfigurierbare Merkmale

**Bohrungsdurchmesser Toleranz \geq IT6:**

- Durchmesser in Abstufungen von 0,001 mm frei wählbar
- In Toleranz \geq IT6 bestellbar

**Spezifikation:**

FXR510Ø[Durchmesser][Toleranz]MF1M-HP145

G-Variante:

- Durchmesser in Abstufungen von 0,001 mm frei wählbar
- Ab Toleranz \geq 4 μ m bestellbar (G-Variante siehe Seite 320)

Spezifikation G-Variante:

FXR510GØ[Durchmesser][Toleranz]MF1M-HP145

Abmessungen konfigurierbare Baureihe IT6

d ₁	d ₂	l ₁	l ₂	l ₃	l ₄	l ₅	z
3,701 - 4,700	6	75	12	36	39	34	4
4,701 - 6,200	6	75	12	36	39	35	4
6,201 - 7,200	8	100	16	36	64	59	6
7,201 - 8,200	8	100	16	36	64	60	6
8,201 - 9,200	10	100	20	40	60	55	6
9,201 - 10,200	10	120	20	40	80	76	6
10,201 - 11,200	12	120	20	45	75	70	6
11,201 - 12,200	12	120	20	45	75	71	6
12,201 - 14,200	14	130	22	45	85	80	6
14,201 - 15,200	16	130	22	48	82	77	6
15,201 - 16,200	16	150	25	48	102	97	6
16,201 - 18,200	18	150	25	48	102	97	8
18,201 - 20,200	20	150	25	50	100	95	8

Beispiel Toleranz IT6:

FXR510Ø16.350H6MF1M-HP145

Bohrungsdurchmesser d₁ = 16,350 H6**Beispiel G-Variante:**

FXR510GØ16.350-4MF1M-HP145

Spezieller Werkzeugdurchmesser d₁ = 16,350 -4 μ m

FixReam

Feste Ausführung, linksschräg genutet, für Durchgangsbohrung
FXR510

Ausführung:

Reibahldurchmesser: 3,701 - 20,200 mm
 Anschnitt: MF1M
 Schneidstoff: HP625
 Hartmetall
 PVD-beschichtet

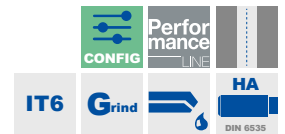
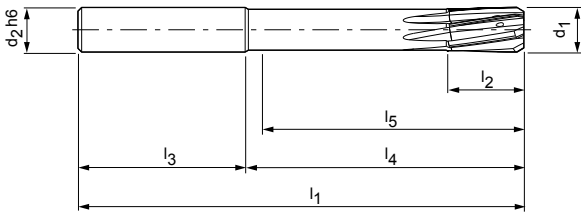

Konfigurierbare Merkmale



Bohrungsdurchmesser Toleranz \geq IT6:
 - Durchmesser in Abstufungen von 0,001 mm frei wählbar
 - In Toleranz \geq IT6 bestellbar

Spezifikation:
 FXR510Ø[Durchmesser][Toleranz]MF1M-HP625

G-Variante:
 - Durchmesser in Abstufungen von 0,001 mm frei wählbar
 - Ab Toleranz \geq 4 μ m bestellbar
 (G-Variante siehe Seite 320)

Spezifikation G-Variante:
 FXR510GØ[Durchmesser][Toleranz]MF1M-HP625

Abmessungen konfigurierbare Baureihe IT6

d ₁	d ₂	l ₁	l ₂	l ₃	l ₄	l ₅	z
3,701 - 4,700	6	75	12	36	39	34	4
4,701 - 6,200	6	75	12	36	39	35	4
6,201 - 7,200	8	100	16	36	64	59	6
7,201 - 8,200	8	100	16	36	64	60	6
8,201 - 9,200	10	100	20	40	60	55	6
9,201 - 10,200	10	120	20	40	80	76	6
10,201 - 11,200	12	120	20	45	75	70	6
11,201 - 12,200	12	120	20	45	75	71	6
12,201 - 14,200	14	130	22	45	85	80	6
14,201 - 15,200	16	130	22	48	82	77	6
15,201 - 16,200	16	150	25	48	102	97	6
16,201 - 18,200	18	150	25	48	102	97	8
18,201 - 20,200	20	150	25	50	100	95	8

Beispiel Toleranz IT6:
 FXR510Ø16.350H6MF1M-HP625

Bohrungsdurchmesser d₁ = 16,350 H6

Beispiel G-Variante:
 FXR510GØ16.350-4MF1M-HP625

Spezieller Werkzeugdurchmesser d₁ = 16,350 -4 μ m

FixReam

Feste Ausführung, linksschräg genutet, für Durchgangsbohrung
FXR510

Ausführung:

Reibahldurchmesser: 3,701 - 20,200 mm
Anschnitt: MF1M
Schneidstoff: HC614
Hartmetall
CVD-beschichtet

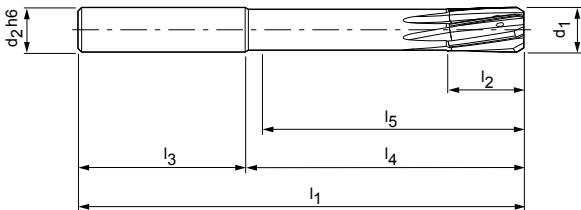

N	1.1	1.2	1.3	1.4	2.1	2.2	2.3	3.1	4.1	4.2	4.3	C	1.1	1.2	1.3	2.1	3.1	4.1	4.2	4.3	4.4	5.1	5.2
---	-----	-----	-----	-----	-----	-----	-----	-----	-----	-----	-----	---	-----	-----	-----	-----	-----	-----	-----	-----	-----	-----	-----

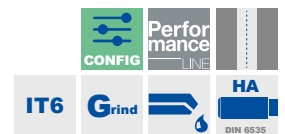

Konfigurierbare Merkmale



Bohrungsdurchmesser Toleranz \geq IT6:

- Durchmesser in Abstufungen von 0,001 mm frei wählbar
- In Toleranz \geq IT6 bestellbar

Spezifikation:

FXR510Ø[Durchmesser][Toleranz]MF1M-HC614

G-Variante:

- Durchmesser in Abstufungen von 0,001 mm frei wählbar
- Ab Toleranz \geq 4 μ m bestellbar (G-Variante siehe Seite 320)

Spezifikation G-Variante:

FXR510GØ[Durchmesser][Toleranz]MF1M-HC614

Abmessungen konfigurierbare Baureihe IT6

d ₁	d ₂	l ₁	l ₂	l ₃	l ₄	l ₅	z
3,701 - 4,700	6	75	12	36	39	34	4
4,701 - 6,200	6	75	12	36	39	35	4
6,201 - 7,200	8	100	16	36	64	59	6
7,201 - 8,200	8	100	16	36	64	60	6
8,201 - 9,200	10	100	20	40	60	55	6
9,201 - 10,200	10	120	20	40	80	76	6
10,201 - 11,200	12	120	20	45	75	70	6
11,201 - 12,200	12	120	20	45	75	71	6
12,201 - 14,200	14	130	22	45	85	80	6
14,201 - 15,200	16	130	22	48	82	77	6
15,201 - 16,200	16	150	25	48	102	97	6
16,201 - 18,200	18	150	25	48	102	97	8
18,201 - 20,200	20	150	25	50	100	95	8

Beispiel Toleranz IT6:

FXR510Ø16.350H6MF1M-HC614

Bohrungsdurchmesser d₁ = 16,350 H6

Beispiel G-Variante:

FXR510GØ16.350-4MF1M-HC614

Spezieller Werkzeugdurchmesser d₁ = 16,350 -4 μ m

FixReam

Feste Ausführung, gerade genutet, für Durchgangsbohrung
FXR500

Ausführung:

Reibahldurchmesser: 3,701 - 20,200 mm
 Anschnitt: MG0A
 Schneidstoff: HP622
 Hartmetall
 PVD-beschichtet

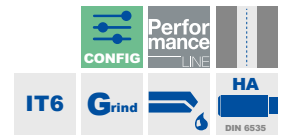
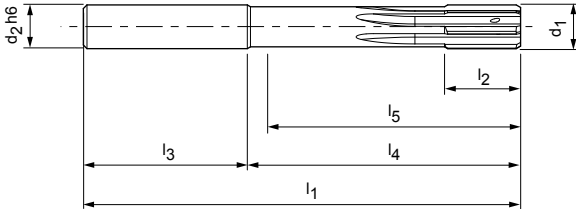

Konfigurierbare Merkmale



Bohrungsdurchmesser Toleranz \geq IT6:

- Durchmesser in Abstufungen von 0,001 mm frei wählbar
- In Toleranz \geq IT6 bestellbar

Spezifikation:

FXR500Ø[Durchmesser][Toleranz]MG0A-HP622

G-Variante:

- Durchmesser in Abstufungen von 0,001 mm frei wählbar
- Ab Toleranz \geq 4 μ m bestellbar (G-Variante siehe Seite 320)

Spezifikation G-Variante:

FXR500GØ[Durchmesser][Toleranz]MG0A-HP622

Abmessungen konfigurierbare Baureihe IT6

d ₁	d ₂	l ₁	l ₂	l ₃	l ₄	l ₅	z
3,701 - 4,700	6	75	12	36	39	34	4
4,701 - 6,200	6	75	12	36	39	35	4
6,201 - 7,200	8	100	16	36	64	59	6
7,201 - 8,200	8	100	16	36	64	60	6
8,201 - 9,200	10	100	20	40	60	55	6
9,201 - 10,200	10	120	20	40	80	76	6
10,201 - 11,200	12	120	20	45	75	70	6
11,201 - 12,200	12	120	20	45	75	71	6
12,201 - 14,200	14	130	22	45	85	80	6
14,201 - 15,200	16	130	22	48	82	77	6
15,201 - 16,200	16	150	25	48	102	97	6
16,201 - 18,200	18	150	25	48	102	97	8
18,201 - 20,200	20	150	25	50	100	95	8

Beispiel Toleranz IT6:

FXR500Ø16.350H6MG0A-HP622

Bohrungsdurchmesser d₁ = 16,350 H6

Beispiel G-Variante:

FXR500GØ16.350-4MG0A-HP622

Spezieller Werkzeugdurchmesser d₁ = 16,350 -4 μ m

FixReam

Feste Ausführung, gerade genutet, für Durchgangsbohrung
FXR500

Ausführung:

Reibahldurchmesser: 3,701 - 20,200 mm
Anschnitt: MF0A
Schneidstoff: HP141
Hartmetall
PVD-beschichtet

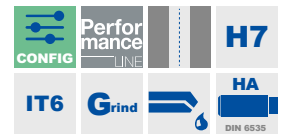
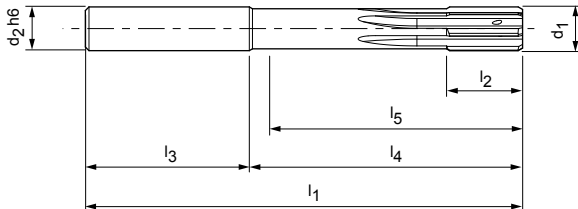

Lagerhaltige Vorzugsbaureihe in H7

d ₁ H7	Baumaße						z	Spezifikation	Bestell-Nr.
	d ₂ h6	l ₁	l ₂	l ₃	l ₄	l ₅			
5,000	6	75	12	36	39	35	4	FXR500Ø5.000H7MF0A-HP141	30570824
6,000	6	75	12	36	39	35	4	FXR500Ø6.000H7MF0A-HP141	30570826
8,000	8	100	16	36	64	60	6	FXR500Ø8.000H7MF0A-HP141	30570830
10,000	10	120	20	40	80	76	6	FXR500Ø10.000H7MF0A-HP141	30570834
12,000	12	120	20	45	75	71	6	FXR500Ø12.000H7MF0A-HP141	30570838

Konfigurierbare Merkmale



Bohrungsdurchmesser Toleranz \geq IT6:

- Durchmesser in Abstufungen von 0,001 mm frei wählbar
- In Toleranz \geq IT6 bestellbar

Spezifikation:

FXR500Ø[Durchmesser][Toleranz]MF0A-HP141

G-Variante:

- Durchmesser in Abstufungen von 0,001 mm frei wählbar
- Ab Toleranz \geq 5 μ m bestellbar (G-Variante siehe Seite 320)

Spezifikation G-Variante:

FXR500GØ[Durchmesser][Toleranz]MF0A-HP141

Abmessungen konfigurierbare Baureihe IT6

d ₁	d ₂	l ₁	l ₂	l ₃	l ₄	l ₅	z
3,701 - 4,700	6	75	12	36	39	34	4
4,701 - 6,200	6	75	12	36	39	35	4
6,201 - 7,200	8	100	16	36	64	59	6
7,201 - 8,200	8	100	16	36	64	60	6
8,201 - 9,200	10	100	20	40	60	55	6
9,201 - 10,200	10	120	20	40	80	76	6
10,201 - 11,200	12	120	20	45	75	70	6
11,201 - 12,200	12	120	20	45	75	71	6
12,201 - 14,200	14	130	22	45	85	80	6
14,201 - 15,200	16	130	22	48	82	77	6
15,201 - 16,200	16	150	25	48	102	97	6
16,201 - 18,200	18	150	25	48	102	97	8
18,201 - 20,200	20	150	25	50	100	95	8

Beispiel Toleranz IT6:

FXR500Ø16.350H6MF0A-HP141

Bohrungsdurchmesser d₁ = 16,350 H6

Beispiel G-Variante:

FXR500GØ16.350-5MF0A-HP141

Spezieller Werkzeugdurchmesser d₁ = 16,350 -5 μ m

FixReam

Feste Ausführung, gerade genutet, für Grundbohrung
FXR505

Ausführung:
Reibahldurchmesser: 2,800 - 20,200 mm
Anschnitt: MV0A
Schneidstoff: HP145
Hartmetall
PVD-beschichtet

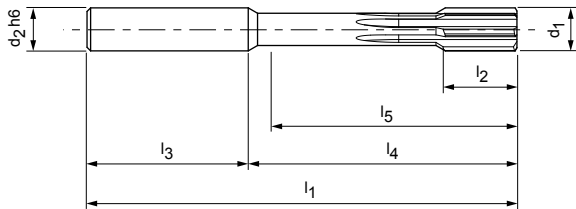

Lagerhaltige Vorzugsbaureihe in H7

d ₁ H7	Baumaße						z	Spezifikation	Bestell-Nr.
	d ₂ h6	l ₁	l ₂	l ₃	l ₄	l ₅			
4,000	6	75	12	36	39	34	4	FXR505Ø4.000H7MV0A-HP145	30570747
5,000	6	75	12	36	39	34	4	FXR505Ø5.000H7MV0A-HP145	30570749
6,000	6	75	12	36	39	34	4	FXR505Ø6.000H7MV0A-HP145	30570751
7,000	8	100	16	36	64	58	6	FXR505Ø7.000H7MV0A-HP145	30570753
8,000	8	100	16	36	64	58	6	FXR505Ø8.000H7MV0A-HP145	30570755
9,000	10	100	20	40	60	54	6	FXR505Ø9.000H7MV0A-HP145	30570757
10,000	10	120	20	40	80	74	6	FXR505Ø10.000H7MV0A-HP145	30570759
11,000	12	120	20	45	75	68	6	FXR505Ø11.000H7MV0A-HP145	30570761
12,000	12	120	20	45	75	68	6	FXR505Ø12.000H7MV0A-HP145	30570763
13,000	14	130	22	45	85	78	6	FXR505Ø13.000H7MV0A-HP145	30570764
14,000	14	130	22	45	85	78	6	FXR505Ø14.000H7MV0A-HP145	30570765
15,000	16	130	22	48	82	75	6	FXR505Ø15.000H7MV0A-HP145	30570766
16,000	16	150	25	48	102	95	6	FXR505Ø16.000H7MV0A-HP145	30570767
17,000	18	150	25	48	102	95	6	FXR505Ø17.000H7MV0A-HP145	30570768
18,000	18	150	25	48	102	95	6	FXR505Ø18.000H7MV0A-HP145	30570769
19,000	20	150	25	50	100	92	6	FXR505Ø19.000H7MV0A-HP145	30570770

Maßangaben in mm.
Schnittwertempfehlung siehe Kapitelende.

FXR505 | Feste Ausführung, gerade genutet

Konfigurierbare Merkmale

**Bohrungsdurchmesser Toleranz \geq IT6:**

- Durchmesser in Abstufungen von 0,001 mm frei wählbar
- In Toleranz \geq IT6 bestellbar

**Spezifikation:**

FXR505Ø[Durchmesser][Toleranz]MVOA-HP145

G-Variante:

- Durchmesser in Abstufungen von 0,001 mm frei wählbar
- Ab Toleranz \geq 4 μ m bestellbar (G-Variante siehe Seite 320)

Spezifikation G-Variante:

FXR505GØ[Durchmesser][Toleranz]MVOA-HP145

Abmessungen konfigurierbare Baureihe IT6

d ₁	d ₂	l ₁	l ₂	l ₃	l ₄	l ₅	z
2,800 - 3,350	4	65	12	37	28	33	4
3,351 - 3,700	4	65	12	28	37	33	4
3,701 - 6,200	6	75	12	36	39	34	4
6,201 - 8,200	8	100	16	36	64	58	6
8,201 - 9,200	10	100	20	40	60	54	6
9,201 - 10,200	10	120	20	40	80	74	6
10,201 - 12,200	12	120	20	45	75	68	6
12,201 - 14,200	14	130	22	45	85	78	6
14,201 - 15,200	16	130	22	48	82	75	6
15,201 - 16,200	16	150	25	48	102	95	6
16,201 - 18,200	18	150	25	48	102	95	6
18,201 - 20,200	20	150	25	50	100	92	6

Beispiel Toleranz IT6:

FXR505Ø16.350H6MVOA-HP145

Bohrungsdurchmesser d₁ = 16,350 H6**Beispiel G-Variante:**

FXR505GØ16.350-4MVOA-HP145

Spezieller Werkzeugdurchmesser d₁ = 16,350 -4 μ m

FixReam

Feste Ausführung, gerade genutet, für Grundbohrung
FXR505

Ausführung:

Reibahldurchmesser: 3,701 - 20,200 mm
 Anschnitt: MTOA
 Schneidstoff: HP145
 Hartmetall
 PVD-beschichtet

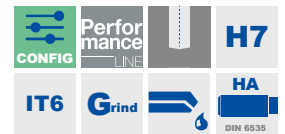
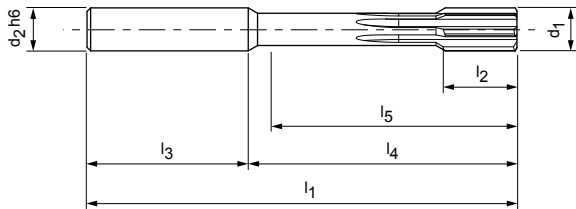

Lagerhaltige Vorzugsbaureihe in H7

d ₁ H7	Baumaße						z	Spezifikation	Bestell-Nr.
	d ₂ h6	l ₁	l ₂	l ₃	l ₄	l ₅			
4,000	6	75	12	36	39	34	4	FXR505Ø4.000H7MT0A-HP145	30570797
5,000	6	75	12	36	39	34	4	FXR505Ø5.000H7MT0A-HP145	30570799
6,000	6	75	12	36	39	34	4	FXR505Ø6.000H7MT0A-HP145	30570801
8,000	8	100	16	36	64	58	6	FXR505Ø8.000H7MT0A-HP145	30570805
10,000	10	120	20	40	80	74	6	FXR505Ø10.000H7MT0A-HP145	30570809
12,000	12	120	20	45	75	68	6	FXR505Ø12.000H7MT0A-HP145	30570813

Konfigurierbare Merkmale

Bohrungsdurchmesser Toleranz ≥ IT6:

- Durchmesser in Abstufungen von 0,001 mm frei wählbar
- In Toleranz ≥ IT6 bestellbar

Spezifikation:
FXR505Ø[Durchmesser][Toleranz]MT0A-HP145

G-Variante:

- Durchmesser in Abstufungen von 0,001 mm frei wählbar
- Ab Toleranz ≥ 4 µm bestellbar (G-Variante siehe Seite 320)

Spezifikation G-Variante:
FXR505GØ[Durchmesser][Toleranz]MT0A-HP145

Abmessungen konfigurierbare Baureihe IT6

d ₁	d ₂	l ₁	l ₂	l ₃	l ₄	l ₅	z
3,701 - 6,200	6	75	12	36	39	34	4
6,201 - 8,200	8	100	16	36	64	58	6
8,201 - 9,200	10	100	20	40	60	54	6
9,201 - 10,200	10	120	20	40	80	74	6
10,201 - 12,200	12	120	20	45	75	68	6
12,201 - 14,200	14	130	22	45	85	78	6
14,201 - 15,200	16	130	22	48	82	75	6
15,201 - 16,200	16	150	25	48	102	95	6
16,201 - 18,200	18	150	25	48	102	95	6
18,201 - 20,200	20	150	25	50	100	92	6

Beispiel Toleranz IT6:
FXR505Ø16.350H6MT0A-HP145

Bohrungsdurchmesser d₁ = 16,350 H6

Beispiel G-Variante:
FXR505GØ16.350-4MT0A-HP145

Spezieller Werkzeugdurchmesser d₁ = 16,350 -4 µm

Maßangaben in mm.
Schnittwertempfehlung siehe Kapitelende.

FixReam

Feste Ausführung, gerade genutet, für Grundbohrung
FXR505

Ausführung:

Reibahldurchmesser: 3,701 - 20,200 mm
Anschnitt: MVOA
Schneidstoff: HP622
Hartmetall
PVD-beschichtet

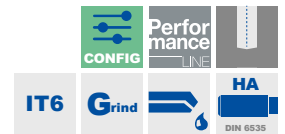
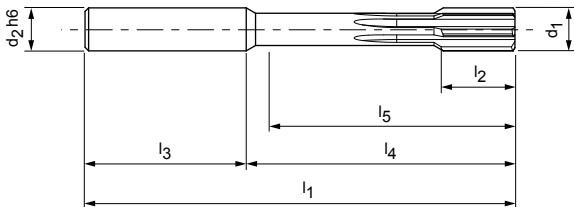

Konfigurierbare Merkmale



Bohrungsdurchmesser Toleranz \geq IT6:

- Durchmesser in Abstufungen von 0,001 mm frei wählbar
- In Toleranz \geq IT6 bestellbar

Spezifikation:

FXR505Ø[Durchmesser][Toleranz]MVOA-HP622

G-Variante:

- Durchmesser in Abstufungen von 0,001 mm frei wählbar
- Ab Toleranz \geq 4 μ m bestellbar (G-Variante siehe Seite 320)

Spezifikation G-Variante:

FXR505GØ[Durchmesser][Toleranz]MVOA-HP622

Abmessungen konfigurierbare Baureihe IT6

d_1	d_2	l_1	l_2	l_3	l_4	l_5	z
3,701 - 6,200	6	75	12	36	39	34	4
6,201 - 8,200	8	100	16	36	64	58	6
8,201 - 9,200	10	100	20	40	60	54	6
9,201 - 10,200	10	120	20	40	80	74	6
10,201 - 12,200	12	120	20	45	75	68	6
12,201 - 14,200	14	130	22	45	85	78	6
14,201 - 15,200	16	130	22	48	82	75	6
15,201 - 16,200	16	150	25	48	102	95	6
16,201 - 18,200	18	150	25	48	102	95	6
18,201 - 20,200	20	150	25	50	100	92	6

Beispiel Toleranz IT6:

FXR505Ø16.350H6MVOA-HP622

Bohrungsdurchmesser $d_1 = 16,350$ H6

Beispiel G-Variante:

FXR505GØ16.350-4MVOA-HP622

Spezieller Werkzeugdurchmesser $d_1 = 16,350 -4 \mu$ m

FixReam

Feste Ausführung, gerade genutet, für Grundbohrung
FXR505

Ausführung:

Reibahldurchmesser: 2,800 - 20,200 mm
Anschnitt: MV0A
Schneidstoff: HU612
Hartmetall
unbeschichtet

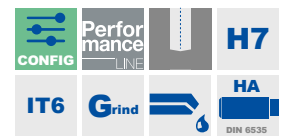
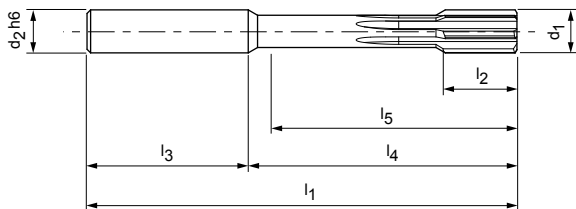

Lagerhaltige Vorzugsbaureihe in H7

d ₁ H7	Baumaße						z	Spezifikation	Bestell-Nr.
	d ₂ h6	l ₁	l ₂	l ₃	l ₄	l ₅			
4,000	6	75	12	36	39	34	4	FXR505Ø4.000H7MV0A-HU612	30570694
5,000	6	75	12	36	39	34	4	FXR505Ø5.000H7MV0A-HU612	30570696
6,000	6	75	12	36	39	34	4	FXR505Ø6.000H7MV0A-HU612	30570698
7,000	8	100	16	36	64	58	6	FXR505Ø7.000H7MV0A-HU612	30570700
8,000	8	100	16	36	64	58	6	FXR505Ø8.000H7MV0A-HU612	30570702
9,000	10	100	20	40	60	54	6	FXR505Ø9.000H7MV0A-HU612	30570704
10,000	10	120	20	40	80	74	6	FXR505Ø10.000H7MV0A-HU612	30570706
12,000	12	120	20	45	75	68	6	FXR505Ø12.000H7MV0A-HU612	30570710
13,000	14	130	22	45	85	78	6	FXR505Ø13.000H7MV0A-HU612	30570711
14,000	14	130	22	45	85	78	6	FXR505Ø14.000H7MV0A-HU612	30570712
15,000	16	130	22	48	82	75	6	FXR505Ø15.000H7MV0A-HU612	30570713
16,000	16	150	25	48	102	95	6	FXR505Ø16.000H7MV0A-HU612	30570714
18,000	18	150	25	48	102	95	6	FXR505Ø18.000H7MV0A-HU612	30570716
19,000	20	150	25	50	100	92	6	FXR505Ø19.000H7MV0A-HU612	30570717

Maßangaben in mm.

Schnittwertempfehlung siehe Kapitelende.

FXR505 | Feste Ausführung, gerade genutet

Konfigurierbare Merkmale

**Bohrungsdurchmesser Toleranz \geq IT6:**

- Durchmesser in Abstufungen von 0,001 mm frei wählbar
- In Toleranz \geq IT6 bestellbar

**Spezifikation:**

FXR505Ø[Durchmesser][Toleranz]MVOA-HU612

G-Variante:

- Durchmesser in Abstufungen von 0,001 mm frei wählbar
- Ab Toleranz \geq 3 μ m bestellbar (G-Variante siehe Seite 320)

Spezifikation G-Variante:

FXR505GØ[Durchmesser][Toleranz]MVOA-HU612

Abmessungen konfigurierbare Baureihe IT6

d ₁	d ₂	l ₁	l ₂	l ₃	l ₄	l ₅	z
2,800 - 3,350	4	65	12	37	28	33	4
3,351 - 3,700	4	65	12	28	37	33	4
3,701 - 6,200	6	75	12	36	39	34	4
6,201 - 8,200	8	100	16	36	64	58	6
8,201 - 9,200	10	100	20	40	60	54	6
9,201 - 10,200	10	120	20	40	80	74	6
10,201 - 12,200	12	120	20	45	75	68	6
12,201 - 14,200	14	130	22	45	85	78	6
14,201 - 15,200	16	130	22	48	82	75	6
15,201 - 16,200	16	150	25	48	102	95	6
16,201 - 18,200	18	150	25	48	102	95	6
18,201 - 20,200	20	150	25	50	100	92	6

Beispiel Toleranz IT6:

FXR505Ø16.350H6MVOA-HU612

Bohrungsdurchmesser d₁ = 16,350 H6**Beispiel G-Variante:**

FXR505GØ16.350-3MVOA-HU612

Spezieller Werkzeugdurchmesser d₁ = 16,350 -3 μ m

FixReam

Feste Ausführung, gerade genutet, für Grundbohrung
FXR505

Ausführung:

Reibahldurchmesser: 3,701 - 20,200 mm
 Anschnitt: MT0A
 Schneidstoff: HP625
 Hartmetall
 PVD-beschichtet

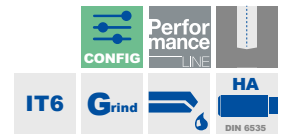
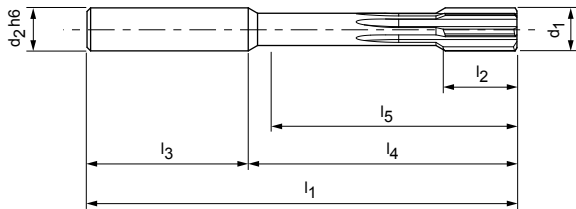

Konfigurierbare Merkmale



Bohrungsdurchmesser Toleranz \geq IT6:
 - Durchmesser in Abstufungen von 0,001 mm frei wählbar
 - In Toleranz \geq IT6 bestellbar

Spezifikation:
 FXR505Ø[Durchmesser][Toleranz]MT0A-HP625

G-Variante:
 - Durchmesser in Abstufungen von 0,001 mm frei wählbar
 - Ab Toleranz \geq 4 μ m bestellbar (G-Variante siehe Seite 320)

Spezifikation G-Variante:
 FXR505GØ[Durchmesser][Toleranz]MT0A-HP625

Abmessungen konfigurierbare Baureihe IT6

d_1	d_2	l_1	l_2	l_3	l_4	l_5	z
3,701 - 6,200	6	75	12	36	39	34	4
6,201 - 8,200	8	100	16	36	64	58	6
8,201 - 9,200	10	100	20	40	60	54	6
9,201 - 10,200	10	120	20	40	80	74	6
10,201 - 12,200	12	120	20	45	75	68	6
12,201 - 14,200	14	130	22	45	85	78	6
14,201 - 15,200	16	130	22	48	82	75	6
15,201 - 16,200	16	150	25	48	102	95	6
16,201 - 18,200	18	150	25	48	102	95	6
18,201 - 20,200	20	150	25	50	100	92	6

Beispiel Toleranz IT6:
 FXR505Ø16.350H6MT0A-HP625

Bohrungsdurchmesser $d_1 = 16,350$ H6

Beispiel G-Variante:
 FXR505GØ16.350-4MT0A-HP625

Spezieller Werkzeugdurchmesser $d_1 = 16,350 -4 \mu$ m

FixReam

Feste Ausführung, gerade genutet, für Grundbohrung
FXR505

Ausführung:

Reibahldurchmesser: 3,701 - 20,200 mm
Anschnitt: MVOA
Schneidstoff: HC614
Hartmetall
CVD-beschichtet

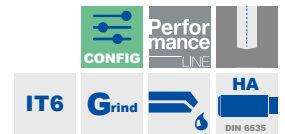
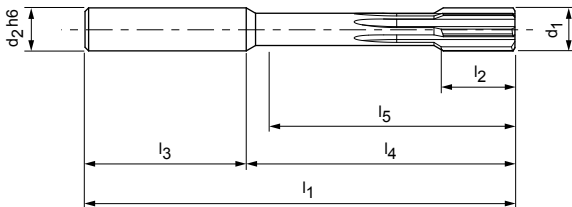

Konfigurierbare Merkmale



Bohrungsdurchmesser Toleranz \geq IT6:

- Durchmesser in Abstufungen von 0,001 mm frei wählbar
- In Toleranz \geq IT6 bestellbar

Spezifikation:

FXR505Ø[Durchmesser][Toleranz]MVOA-HC614

G-Variante:

- Durchmesser in Abstufungen von 0,001 mm frei wählbar
- Ab Toleranz \geq 4 μ m bestellbar (G-Variante siehe Seite 320)

Spezifikation G-Variante:

FXR505GØ[Durchmesser][Toleranz]MVOA-HC614

Abmessungen konfigurierbare Baureihe IT6

d_1	d_2	l_1	l_2	l_3	l_4	l_5	z
3,701 - 6,200	6	75	12	36	39	34	4
6,201 - 8,200	8	100	16	36	64	58	6
8,201 - 9,200	10	100	20	40	60	54	6
9,201 - 10,200	10	120	20	40	80	74	6
10,201 - 12,200	12	120	20	45	75	68	6
12,201 - 14,200	14	130	22	45	85	78	6
14,201 - 15,200	16	130	22	48	82	75	6
15,201 - 16,200	16	150	25	48	102	95	6
16,201 - 18,200	18	150	25	48	102	95	6
18,201 - 20,200	20	150	25	50	100	92	6

Beispiel Toleranz IT6:

FXR505Ø16.350H6MVOA-HC614

Bohrungsdurchmesser $d_1 = 16,350$ H6

Beispiel G-Variante:

FXR505GØ16.350-4MVOA-HC614

Spezieller Werkzeugdurchmesser $d_1 = 16,350 -4 \mu$ m

FixReam

Feste Ausführung, gerade genutet, für Grundbohrung
FXR505

Ausführung:

Reibahldurchmesser: 3,701 - 20,200 mm
Anschnitt: MTOA
Schneidstoff: HP141
Hartmetall
PVD-beschichtet

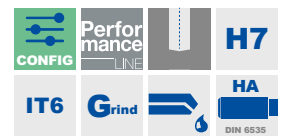
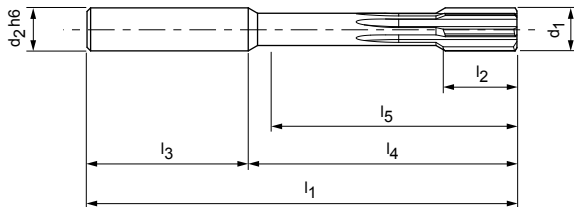

FXR505 | Feste Ausführung, gerade genutet

Konfigurierbare Merkmale

**Bohrungsdurchmesser Toleranz \geq IT6:**

- Durchmesser in Abstufungen von 0,001 mm frei wählbar
- In Toleranz \geq IT6 bestellbar

**Spezifikation:**

FXR505Ø[Durchmesser][Toleranz]MT0A-HP141

G-Variante:

- Durchmesser in Abstufungen von 0,001 mm frei wählbar
- Ab Toleranz \geq 5 μ m bestellbar (G-Variante siehe Seite 320)

Spezifikation G-Variante:

FXR505GØ[Durchmesser][Toleranz]MT0A-HP141

Abmessungen konfigurierbare Baureihe IT6

d ₁	d ₂	l ₁	l ₂	l ₃	l ₄	l ₅	z
3,701 - 6,200	6	75	12	36	39	34	4
6,201 - 8,200	8	100	16	36	64	58	6
8,201 - 9,200	10	100	20	40	60	54	6
9,201 - 10,200	10	120	20	40	80	74	6
10,201 - 12,200	12	120	20	45	75	68	6
12,201 - 14,200	14	130	22	45	85	78	6
14,201 - 15,200	16	130	22	48	82	75	6
15,201 - 16,200	16	150	25	48	102	95	6
16,201 - 18,200	18	150	25	48	102	95	6
18,201 - 20,200	20	150	25	50	100	92	6

Beispiel Toleranz IT6:

FXR505Ø16.350H6MT0A-HP141

Bohrungsdurchmesser d₁ = 16,350 H6**Beispiel G-Variante:**

FXR505GØ16.350-5MT0A-HP141

Spezieller Werkzeugdurchmesser d₁ = 16,350 -5 μ m

FixReam

Feste Ausführung, gerade genutet, für Grundbohrung
FXR503-short

Ausführung:

Reibahldurchmesser: 2,800 - 20,100 mm
 Anschnitt: MC1F
 Schneidstoff: HP145
 Hartmetall
 PVD-beschichtet

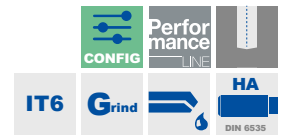
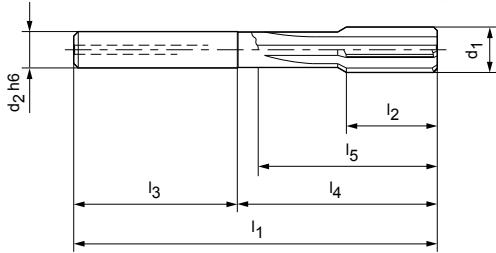

Konfigurierbare Merkmale



Bohrungsdurchmesser Toleranz \geq IT6:

- Durchmesser in Abstufungen von 0,001 mm frei wählbar
- In Toleranz \geq IT6 bestellbar

Spezifikation:

FXR503Ø[Durchmesser][Toleranz]MC1F-HP145

G-Variante:

- Durchmesser in Abstufungen von 0,001 mm frei wählbar
- Ab Toleranz \geq 4 μ m bestellbar (G-Variante siehe Seite 320)

Spezifikation G-Variante:

FXR503GØ[Durchmesser][Toleranz]MC1F-HP145

Abmessungen konfigurierbare Baureihe IT6

d ₁	d ₂	l ₁	l ₂	l ₃	l ₄	l ₅	z
2,800 - 4,050	4	56	12	28	28	24	4
4,051 - 5,100	6	64	12	36	28	23	4
5,101 - 5,600	6	64	12	36	28	24	4
6,101 - 6,600	8	75	16	36	39	32	6
6,601 - 7,100	8	75	16	36	39	34	6
7,101 - 8,100	8	75	16	36	39	35	6
8,101 - 10,100	8	75	20	36	39	35	6
10,101 - 11,600	10	80	20	40	40	35	6
11,601 - 13,100	12	90	22	45	45	40	6
13,101 - 15,100	14	90	22	45	45	40	6
15,101 - 18,100	16	100	25	48	52	47	8
18,101 - 20,100	18	100	25	48	52	47	8

Beispiel Toleranz IT6:

FXR503Ø16.350H6MC1F-HP145

Bohrungsdurchmesser d₁ = 16,350 H6

Beispiel G-Variante:

FXR503GØ16.350-4MC1F-HP145

Spezieller Werkzeugdurchmesser d₁ = 16,350 -4 μ m



Schnittwertempfehlung für FixReam FXR

Vorschub und Schnittgeschwindigkeit

FXR510 | FXR505

Schneidstoff: HP145 | Anschnitt: MF1M | MTOA

MZG*	Werkstoff	Festigkeit/Härte [N/mm ²] [HRC]	Schnittgeschwindigkeit v _c (m/min)			
			Innenkühlung	Außenkühlung	MMS	
P	P4 P4.1	Rostfreie Stähle, ferritisch und martensitisch	40	20	30	
	P6 P6.1	Rostfreier Stahlguss, ferritisch und martensitisch	40	20	30	
M	M1 M1.1	Rostfreie Stähle, austenitisch	< 700	40	20	30
	M1 M1.2	Rostfreie Stähle, ferritisch/austenitisch (Duplex)	< 1000	30	15	20
	M2 M2.1	Rostfreier Stahlguss, austenitisch	< 700	40	20	30
	M3 M3.1	Rostfreier Stahlguss, ferritisch/austenitisch (Duplex)	< 1000	30	15	20

FXR510 | FXR505

Schneidstoff: HP145 | Anschnitt: MG1M | MVOA

MZG*	Werkstoff	Festigkeit/Härte [N/mm ²] [HRC]	Schnittgeschwindigkeit v _c (m/min)			
			Innenkühlung	Außenkühlung	MMS	
P	P1 P1.1	Bau-, Automaten-, Einsatz- und Vergütungsstähle, unlegiert	< 700	180	90	150
	P1 P1.2	Bau-, Automaten-, Einsatz- und Vergütungsstähle, unlegiert	< 1200	140	70	115
	P2 P2.1	Nitrier-, Einsatz- und Vergütungsstähle, legiert	< 900	180	90	150
	P2 P2.2	Nitrier-, Einsatz- und Vergütungsstähle, legiert	< 1400	140	70	115
	P3 P3.1	Werkzeug-, Wälzlager-, Feder- und Schnellarbeitsstähle**	< 800	180	90	150
	P3 P3.2	Werkzeug-, Wälzlager-, Feder- und Schnellarbeitsstähle**	< 1000	140	70	110
	P3 P3.3	Werkzeug-, Wälzlager-, Feder- und Schnellarbeitsstähle**	< 1500	120	60	90
P6	P5.1	Stahlguss	140	75	100	
K	K1 K1.1	Gusseisen mit Lamellengraphit (Grauguss), GJL	< 300	120	100	100
	K2 K2.1	Gusseisen mit Kugelgraphit, GJS	< 500	150	105	130
	K2 K2.2	Gusseisen mit Kugelgraphit, GJS	≤ 800	120	85	98
	K2 K2.3	Gusseisen mit Kugelgraphit, GJS	> 800	90	55	70
	K3 K3.1	Gusseisen mit Vermiculargraphit, GJV; Temperguss, GJM	< 500	90	55	70
	K3 K3.2	Gusseisen mit Vermiculargraphit, GJV; Temperguss, GJM	> 500	90	55	70

* MAPAL Zerspanungsgruppen

** Wenn die Legierungsbestandteile Cr, Mo, Ni, V, W in Summe > 8 %, dann die nächst höhere MAPAL Zerspanungsgruppe wählen.

	Vorschub f_z (mm/U) bei Werkzeugdurchmesser						
	z 4	z 4	z 6	z 6	z 6	z 6	z 8
	< 5,000	> 5,000 - 6,200	> 6,200 - 8,000	> 8,000 - 12,000	> 12,000 - 16,000	> 16,000 - 16,200	> 16,200 - 20,200
	0,020	0,040	0,060	0,080	0,100	0,120	0,120
	0,020	0,040	0,060	0,080	0,100	0,120	0,120
	0,020	0,040	0,060	0,080	0,100	0,120	0,120
	0,020	0,040	0,060	0,080	0,100	0,120	0,120
	0,020	0,040	0,060	0,080	0,100	0,120	0,120
	0,020	0,040	0,060	0,080	0,100	0,120	0,120

	Vorschub f_z (mm/U) bei Werkzeugdurchmesser						
	z 4	z 4	z 6	z 6	z 6	z 6	z 8
	< 5,000	> 5,000 - 6,200	> 6,200 - 8,000	> 8,000 - 12,000	> 12,000 - 16,000	> 16,000 - 16,200	> 16,200 - 20,200
	0,050	0,080	0,080	0,140	0,180	0,180	0,190
	0,050	0,080	0,080	0,140	0,180	0,180	0,190
	0,050	0,080	0,080	0,140	0,180	0,180	0,190
	0,050	0,080	0,080	0,140	0,180	0,180	0,190
	0,050	0,080	0,080	0,140	0,180	0,180	0,190
	0,050	0,080	0,080	0,140	0,180	0,180	0,190
	0,050	0,080	0,080	0,140	0,180	0,180	0,190
	0,050	0,080	0,080	0,140	0,180	0,180	0,190
	0,080	0,100	0,100	0,170	0,220	0,220	0,230
	0,080	0,100	0,100	0,170	0,220	0,220	0,230
	0,080	0,100	0,100	0,170	0,220	0,220	0,230
	0,080	0,100	0,100	0,170	0,220	0,220	0,230
	0,080	0,100	0,100	0,170	0,220	0,220	0,230
	0,080	0,100	0,100	0,170	0,220	0,220	0,230

Die angegebenen Schnittwerte sind Richtwerte.

Die für den jeweiligen Bearbeitungsfall optimalen Daten sollten im Versuch oder während der Bearbeitung ermittelt werden.

Schnittwertempfehlung für FixReam FXR

Vorschub und Schnittgeschwindigkeit

FXR503-short

Schneidstoff: HP145 | Anschnitt: MC1F

MZG*	Werkstoff	Festigkeit/Härte [N/mm ²] [HRC]	Schnittgeschwindigkeit v _c (m/min)			
			Innenkühlung	Außenkühlung	MMS	
P	P1	P1.1 Bau-, Automaten-, Einsatz- und Vergütungsstähle, unlegiert	< 700	180	90	150
		P1.2 Bau-, Automaten-, Einsatz- und Vergütungsstähle, unlegiert	< 1200	140	70	115
	P2	P2.1 Nitrier-, Einsatz- und Vergütungsstähle, legiert	< 900	180	90	150
		P2.2 Nitrier-, Einsatz- und Vergütungsstähle, legiert	< 1400	140	70	115
	P3	P3.1 Werkzeug-, Wälzlager-, Feder- und Schnellarbeitsstähle**	< 800	180	90	150
		P3.2 Werkzeug-, Wälzlager-, Feder- und Schnellarbeitsstähle**	< 1000	140	70	110
		P3.3 Werkzeug-, Wälzlager-, Feder- und Schnellarbeitsstähle**	< 1500	120	60	90
	P6	P5.1 Stahlguss		140	75	100
K	K1	K1.1 Gusseisen mit Lamellengraphit (Grauguss), GJL	< 300	120	100	100
		K2.1 Gusseisen mit Kugelgraphit, GJS	< 500	150	105	130
	K2	K2.2 Gusseisen mit Kugelgraphit, GJS	≤ 800	120	85	98
		K2.3 Gusseisen mit Kugelgraphit, GJS	> 800	90	55	70
	K3	K3.1 Gusseisen mit Vermiculargraphit, GJV; Temperguss, GJM	< 500	90	55	70
		K3.2 Gusseisen mit Vermiculargraphit, GJV; Temperguss, GJM	> 500	90	55	70

FXR505 | FXR500

Schneidstoff: HP622 | Anschnitt: MVOA | MGOA

MZG*	Werkstoff	Festigkeit/Härte [N/mm ²] [HRC]	Schnittgeschwindigkeit v _c (m/min)			
			Innenkühlung	Außenkühlung	MMS	
N	N1	N1.1 Aluminium, unlegiert und legiert < 3 % Si		250	125	190
		N1.2 Aluminium, legiert ≤ 7 % Si		250	125	190
		N1.3 Aluminium, legiert > 7-12 % Si		250	125	190
		N1.4 Aluminium, legiert > 12 % Si		250	125	190

FXR505 | FXR510

Schneidstoff: HU612 | Anschnitt: MVOA | MG1M

MZG*	Werkstoff	Festigkeit/Härte [N/mm ²] [HRC]	Schnittgeschwindigkeit v _c (m/min)		
			Innenkühlung	Außenkühlung	MMS
N2	N2.1 Kupfer, unlegiert und niedriglegiert	< 300	50	25	
	N2.2 Kupfer, legiert	> 300	50	25	
	N2.3 Messing, Bronze, Rotguss	< 1200	50	25	40

* MAPAL Zerspanungsgruppen

** Wenn die Legierungsbestandteile Cr, Mo, Ni, V, W in Summe > 8 %, dann die nächst höhere MAPAL Zerspanungsgruppe wählen.

	Vorschub f_z (mm/U) bei Werkzeugdurchmesser						
	z 4	z 4	z 6	z 6	z 6	z 8	z 8
	< 5,000	> 5,000 - 6,100	> 6,100 - 8,000	> 8,000 - 12,000	> 12,000 - 15,100	> 15,100 - 16,000	> 16,000 - 20,100
	0,050	0,080	0,080	0,140	0,180	0,180	0,190
	0,050	0,080	0,080	0,140	0,180	0,180	0,190
	0,050	0,080	0,080	0,140	0,180	0,180	0,190
	0,050	0,080	0,080	0,140	0,180	0,180	0,190
	0,050	0,080	0,080	0,140	0,180	0,180	0,190
	0,050	0,080	0,080	0,140	0,180	0,180	0,190
	0,050	0,080	0,080	0,140	0,180	0,180	0,190
	0,050	0,080	0,080	0,140	0,180	0,180	0,190
	0,08	0,10	0,10	0,17	0,22	0,22	0,23
	0,08	0,10	0,10	0,17	0,22	0,22	0,23
	0,08	0,10	0,10	0,17	0,22	0,22	0,23
	0,08	0,10	0,10	0,17	0,22	0,22	0,23
	0,08	0,10	0,10	0,17	0,22	0,22	0,23
	0,08	0,10	0,10	0,17	0,22	0,22	0,23

	Vorschub f_z (mm/U) bei Werkzeugdurchmesser						
	z 4	z 4	z 6	z 6	z 6	z 6	z 6
	< 5,000	> 5,000 - 6,200	> 6,200 - 8,000	> 8,000 - 12,000	> 12,000 - 16,000	> 16,000 - 16,200	> 16,200 - 20,200
	0,120	0,150	0,150	0,210	0,250	0,250	0,300
	0,120	0,150	0,150	0,210	0,250	0,250	0,300
	0,120	0,150	0,150	0,210	0,250	0,250	0,300
	0,120	0,150	0,150	0,210	0,250	0,250	0,300

	Vorschub f_z (mm/U) bei Werkzeugdurchmesser						
	z 4	z 4	z 6	z 6	z 6	z 6	z 8
	< 5,000	> 5,000 - 6,200	> 6,200 - 8,000	> 8,000 - 12,000	> 12,000 - 16,000	> 16,000 - 16,200	> 16,200 - 20,200
	0,040	0,050	0,050	0,060	0,100	0,100	0,100
	0,040	0,050	0,050	0,060	0,100	0,100	0,100
	0,040	0,050	0,050	0,060	0,100	0,100	0,100

Die angegebenen Schnittwerte sind Richtwerte.

Die für den jeweiligen Bearbeitungsfall optimalen Daten sollten im Versuch oder während der Bearbeitung ermittelt werden.

Schnittwertempfehlung für FixReam FXR

Vorschub und Schnittgeschwindigkeit

FXR510 | FXR505

Schneidstoff: HP625 | Anschnitt: MF1M | MTOA

MZG*	Werkstoff	Festigkeit/Härte [N/mm ²] [HRC]	Schnittgeschwindigkeit v _c (m/min)			
			Innenkühlung	Außenkühlung	MMS	
S	S1 S1.1	Titan, Titanlegierungen	< 400	25	10	15
	S2 S2.1	Titan, Titanlegierungen	< 1200	25	10	15
	S2 S2.2	Titan, Titanlegierungen	> 1200	25	10	15
	S3 S3.1	Nickel, unlegiert und legiert	< 900	25	10	15
	S3 S3.2	Nickel, unlegiert und legiert	> 900	25	10	15
	S4 S4.1	Hochwarmfeste Superlegierung, Ni-, Co-, und Fe-basiert		25	10	15
	S5 S5.1	Wolfram- und Molybdänlegierungen		25	10	15

FXR510 | FXR505

Schneidstoff: HC614 | Anschnitt: MF1M | MVOA

MZG*	Werkstoff	Festigkeit/Härte [N/mm ²] [HRC]	Schnittgeschwindigkeit v _c (m/min)			
			Innenkühlung	Außenkühlung	MMS	
C	C1 C1.1	Kunststoffmatrix, Aramidfaserverstärkt (AFK)		50	25	30
	C1 C1.2	Kunststoffmatrix (duroplastisch), CFK/GFK		50	25	30
	C1 C1.3	Kunststoffmatrix (thermoplastisch), CFK/GFK		50	25	30

FXR500 | FXR505

Schneidstoff: HP141 | Anschnitt: MFOA | MTOA

MZG*	Werkstoff	Festigkeit/Härte [N/mm ²] [HRC]	Schnittgeschwindigkeit v _c (m/min)			
			Innenkühlung	Außenkühlung	MMS	
H	H1 H1.1	Gehärteter Stahl/Stahlguss	< 44	50	20	30
	H1 H1.2	Gehärteter Stahl/Stahlguss	< 55	10	5	5

	Vorschub f_z (mm/U) bei Werkzeugdurchmesser						
	z 4	z 4	z 6	z 6	z 6	z 6	z 8
	< 5,000	> 5,000 - 6,200	> 6,200 - 8,000	> 8,000 - 12,000	> 12,000 - 16,000	> 16,000 - 16,200	> 16,200 - 20,200
	0,020	0,040	0,060	0,080	0,100	0,100	0,100
	0,020	0,040	0,060	0,080	0,100	0,100	0,100
	0,020	0,040	0,060	0,080	0,100	0,100	0,100
	0,020	0,040	0,060	0,080	0,100	0,100	0,100
	0,020	0,040	0,060	0,080	0,100	0,100	0,100
	0,020	0,040	0,060	0,080	0,100	0,100	0,100
	0,020	0,040	0,060	0,080	0,100	0,100	0,100

	Vorschub f_z (mm/U) bei Werkzeugdurchmesser						
	z 4	z 4	z 6	z 6	z 6	z 6	z 8
	< 5,000	> 5,000 - 6,200	> 6,200 - 8,000	> 8,000 - 12,000	> 12,000 - 16,000	> 16,000 - 16,200	> 16,200 - 20,200
	0,060	0,100	0,100	0,100	0,100	0,100	0,100
	0,060	0,100	0,100	0,100	0,100	0,100	0,100
	0,060	0,100	0,100	0,100	0,100	0,100	0,100

	Vorschub f_z (mm/U) bei Werkzeugdurchmesser						
	z 4	z 4	z 6	z 6	z 6	z 6	z 6
	< 5,000	> 5,000 - 6,200	> 6,200 - 8,000	> 8,000 - 12,000	> 12,000 - 16,000	> 16,000 - 16,200	> 16,200 - 20,200
	0,015	0,025	0,020	0,040	0,050	0,050	0,050
	0,015	0,025	0,020	0,040	0,050	0,050	0,050

Die angegebenen Schnittwerte sind Richtwerte.

Die für den jeweiligen Bearbeitungsfall optimalen Daten sollten im Versuch oder während der Bearbeitung ermittelt werden.

PRODUKTÜBERSICHT

MonoReam 700 Baureihe

Die Mehrschneidenreibahnen der MonoReam 700 Baureihe bieten ein neues, einfaches, leistungsfähiges und standardisiertes Reibsystem. Die Reibahnen der MonoReam Baureihe sind als dehnbare Version verfügbar. Je nach Anwendungsfeld und Werkstoff sind sie als linksschräge oder geradegenutete Version für Durchgangs- und Grundbohrungen sowie mit unterschiedlichen Anschnitten und Schneidstoffen verfügbar.

MonoReam Plus

Die MonoReam Plus Baureihe ist speziell für die Bearbeitung von Guss und Stahl ausgelegt. Die Reibahnen dieser Baureihe sind mit einer innovativen und patentierten Kühlmittelführung versehen. Dabei sichert eine Hülse die optimale Kühlmittelversorgung der HPC-Schneiden.

Das Programm für Durchgangs- und Grundbohrungen eignet sich optimal für die Bearbeitungen im Durchmesserbereich 3,850 bis 8,200 mm.

MonoReam



MonoReam 700

Gerade genutete Ausführung zur Bearbeitung von Durchgangsbohrungen von Nichteisenmetallen mit unbeschichteten Hartmetallschneiden (PKD-Schneiden auf Anfrage).

Ø-Bereich: 7,700 - 40,200 mm*



N



MonoReam 710

Linksschräg genutete Ausführung zur Bearbeitung von Durchgangsbohrungen mit unbeschichteten oder beschichteten Hartmetallschneiden.

Ø-Bereich: 7,700 - 40,200 mm*



P K



MonoReam 705

Gerade genutete Ausführung zur Bearbeitung von Grundbohrungen mit unbeschichteten oder beschichteten Hartmetallschneiden (PKD-Schneiden auf Anfrage).

Ø-Bereich: 7,700 - 40,200 mm*



P K N



Systemerklärung Baureihe 700

Die MonoReam Reibahlen der Baureihe 700 werden als festes Werkzeug eingesetzt, jedoch ist diese Baureihe für das Nachschleifen optimiert. Durch eine einteilige Dehnschraube wird die Reibahle im Durchmesser aufgeweitet. Das Dehnsystem eignet sich lediglich zur Kompensation vor dem Nachschleifen und nicht zum Ein- oder Nachstellen des Durchmessers. Durch das Aufweiten des Durchmessers ist es möglich, alle Funktionsflächen nachzuschleifen, sowohl im Anschnitt, als auch im Werkzeugdurchmesser.

MonoReam Plus



MonoReam Plus | MRP510 Vollcermetkopf

Hochleistungsreibahle mit Vollcermetkopf, linksschräg genutet,

Ø-Bereich: 3,850 - 8,200 mm



MonoReam Plus | MRP505 Vollcermetkopf

Hochleistungsreibahle mit Vollcermetkopf, gerade genutet,

Ø-Bereich: 3,850 - 8,200 mm



Auswahlübersicht MonoReam | MonoReam Plus (1/2)

Pro- dukt- klasse	Bohrungsart	Materialeignung											
		P					K					N	
		1-2	3.1	3.2	3.3	4-6	1	2.1	2.2	2.3	K3	1-2	4
Perfor- mance		■	■	■			■	■	■	■			
		■	■	■	■	■	■	■	■	■	■		
												■	■
		■	■	■			■	■	■	■			
		■	■	■	■	■	■	■	■	■	■		
												■	■
		■	■	■			■	■					
		■	■	■			■	■					

Bestellbeispiel:

Baureihe MonoReam Plus

M R P

MonoReam Plus

5 1 0

Schrägungswinkel der Schneiden:
0 = Gerade genutet
1 = Linksschräg genutet

Ausführungen:
5 = Feste Reibahle, Vollcermetkopf

Durchmesser

∅ 0 7 . 5 0 0

Bohrungsart:
0 = Durchgangsbohrung
5 = Grundbohrung

Bohrungsdurchmesser

Toleranz

- 3

IT oder Abmaße in µm (Beispiel: +30+10) oder bei G-Variante Angabe der Fertigungstoleranz des Werkzeugschleifdurchmessers zum Beispiel -3µm

Bestellbeispiel:

Baureihe MonoReam

M O R

MonoReam

7 0 0

Ausführungen:
7 = Dehnreibahle

Durchmesser

∅ 2 0 . 0 0 0

Bohrungsart:
0 = Durchgangsbohrung
5 = Grundbohrung

Bohrungsdurchmesser







Toleranz

- 3

IT oder Abmaße in µm (Beispiel: +30+10) oder bei G-Variante Angabe der Fertigungstoleranz des Werkzeugschleifdurchmessers zum Beispiel -3µm

Schrägungswinkel der Schneiden:
0 = Gerade genutet
1 = Linksschräg genutet

Schritt 1:
ProduktklasseSchritt 2:
BohrungsartSchritt 3:
MaterialeignungSchritt 4:
AusführungSchritt 5:
Vorkonfigurierte Durchmesser oder Konfiguration

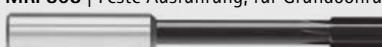
	Ausführung					Vorkonfigurierte Durchmesser		Konfiguration
	d ₁	Schneidstoff	Anschnitt	 fest	 dehnbar	Baureihe	Seite	
	7,700 - 40,200	CU130	MY1G		■	MOR710	356	MOR710 Dehnbare Ausführung, für Durchgangsbohrung 
	7,700 - 40,200	HP421	MY1G		■	MOR710	357	
	7,700 - 40,200	HU612	MY1G		■	MOR700	358	MOR700 
	7,700 - 40,200	CU130	MU2A		■	MOR705	359	MOR705 Dehnbare Ausführung, für Grundbohrung 
	7,700 - 40,200	HP421	MU2A		■	MOR705	360	
	7,700 - 40,200	HU612	MU2A		■	MOR705	361	
	3,850 - 8,200	CU178	MG1M	■		MRP510	362	MRP510 Feste Ausführung, für Durchgangsbohrung 
	3,850 - 8,200	CU178	MV3C	■		MRP505	363	MRP505 Feste Ausführung, für Grundbohrung 

Anschnitt [Lead]

Schneidstoff [Cut]

M	G	1	M	-	C	U	1	7	8
---	---	---	---	---	---	---	---	---	---

Anschnittform und
Spanwinkel:
MG1M
MV3C

Erklärung der
Anschnittgeometrien
siehe Seite 752.

Schneidstoff:
CU178

Anschnitt [Lead]

Schneidstoff [Cut]

M	Y	1	G	-	C	P	1	3	6
---	---	---	---	---	---	---	---	---	---

Anschnittform und
Spanwinkel:
MY1G
MU2A

Erklärung der
Anschnittgeometrien
siehe Seite 752.

Schneidstoff:
HP421
HU612
CU130
PKD auf Anfrage

Auswahlübersicht MonoReam | MonoReam Plus Konfiguration (2/2)

MOR710

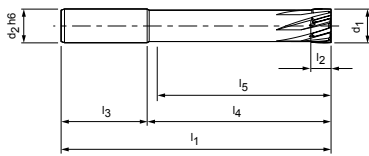

MOR700

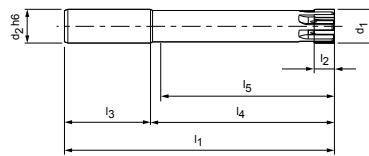

MOR705

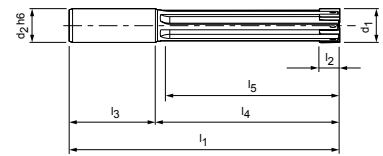

Werkzeugabmessungen

MOR710 | MOR700

d ₁	d ₂	l ₁	l ₂	l ₃	l ₄	l ₅	z
7,700 - 9,700	12	120	8	45	75	70	4
9,701 - 11,700	12	120	8	45	75	70	6
11,701 - 17,200	16	140	8	48	92	87	6
17,201 - 22,200	20	160	12	50	110	105	6
22,201 - 27,200	20	180	12	50	130	125	6
27,201 - 29,200	25	200	12	56	144	139	6
29,201 - 40,200	25	200	12	56	144	139	8

MOR705

d ₁	d ₂	l ₁	l ₂	l ₃	l ₄	l ₅	z
7,700 - 9,700	12	120	8	45	75	64	4
9,701 - 11,700	12	120	8	45	75	65	6
11,701 - 17,200	16	140	8	48	92	80	6
17,201 - 18,200	20	160	12	50	110	98	6
18,201 - 19,200	20	160	12	50	110	99	6
19,201 - 22,200	20	160	12	50	110	100	6
22,201 - 27,200	20	180	12	50	130	120	6
27,201 - 29,200	25	200	12	56	144	130	6
29,201 - 40,200	25	200	12	56	144	130	8



MRP510

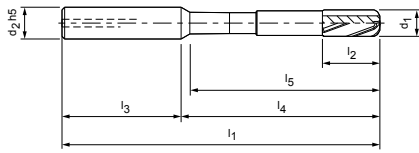

MRP505

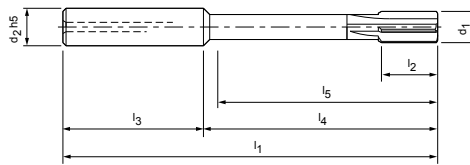
**Werkzeugabmessungen**

MRP510

d ₁	d ₂	l ₁	l ₂	l ₃	l ₄	l ₅	z
3,850 - 4,900	10	80	14	40	40	33	4
4,901 - 6,200	12	85	14	45	40	33	4
6,201 - 6,700	12	105	14	45	60	52	6
6,701 - 8,200	12	110	18	45	65	57	6

MRP505

d ₁	d ₂	l ₁	l ₂	l ₃	l ₄	l ₅	z
3,850 - 4,900	10	80	12	40	40	33	4
4,901 - 6,200	12	85	12	45	40	33	4
6,201 - 6,700	12	105	12	45	60	53	6
6,701 - 8,200	12	110	16	45	65	58	6

Toleranzen für die G-Variante/feste Variante MOR7XX | MRP5XX:

Schneidstoff	Durchmesserbereich
	Ø 7,700 - 40,200
Unbeschichtet	-0,003
CU130	
HU612	
CU178	
Beschichtet (Schichtdicke 1 - 2 µm)	-0,004
HP421	
CP136	

Erklärung G-Variante MOR | MRP

Zulässige Werkstücktoleranzen zur Auswahl des Werkzeugdurchmessers

Ausführung G-Variante:

Die G-Variante gibt den Werkzeugdurchmesser der Reibahle mit unseren Fertigungstoleranzen an. Die Fertigungstoleranzen sind vom Schneidstoff abhängig. Siehe zulässige kleinste Toleranzen für die G-Variante.

MonoReam

Dehbare Ausführung, für Durchgangsbohrung
MOR710

Ausführung:
Reibahldurchmesser: 7,700 - 40,200 mm
Anschnitt: MY1G
Schneidstoff: CU130
Cermet unbeschichtet

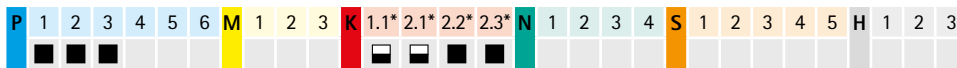
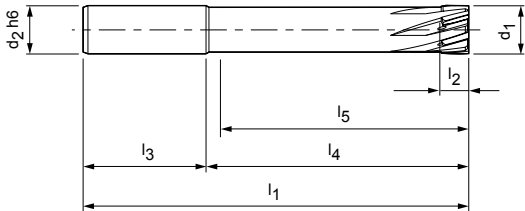

Konfigurierbare Merkmale

Bohrungsdurchmesser Toleranz \geq IT6:

- Durchmesser in Abstufungen von 0,001 mm frei wählbar
- In Toleranz \geq IT6 bestellbar

Spezifikation:
MOR710Ø[Durchmesser][Toleranz]MY1G-CU130

G-Variante:

- Durchmesser in Abstufungen von 0,001 mm frei wählbar
- Ab Toleranz \geq 3 μ m bestellbar (G-Variante siehe Seite 355)

Spezifikation G-Variante:
MOR710GØ[Durchmesser][Toleranz]MY1G-CU130

Abmessungen konfigurierbare Baureihe IT6

d ₁	d ₂	l ₁	l ₂	l ₃	l ₄	l ₅	z
7,700 - 9,700	12	120	8	45	75	70	4
9,701 - 11,700	12	120	8	45	75	70	6
11,701 - 17,200	16	140	8	48	92	87	6
17,201 - 22,200	20	160	12	50	110	105	6
22,201 - 27,200	20	180	12	50	130	125	6
27,201 - 29,200	25	200	12	56	144	139	6
29,201 - 40,200	25	200	12	56	144	139	8

Beispiel Toleranz IT6:
MOR710Ø16.350H6MY1G-CU130

Bohrungsdurchmesser d₁ = 16,350 H6

Beispiel G-Variante:
MOR710GØ16.350-3MY1G-CU130

Spezieller Werkzeugdurchmesser d₁ = 16,350 -3 μ m

Maßangaben in mm.
* für Oberflächen R_a < 2 μ m
Schnittwertempfehlung siehe Kapitelende.

MonoReam

Dehbare Ausführung, für Durchgangsbohrung
MOR710

Ausführung:

Reibahldurchmesser: 7,700 - 40,200 mm
Anschnitt: MY1G
Schneidstoff: HP421
Hartmetall
PVD-beschichtet

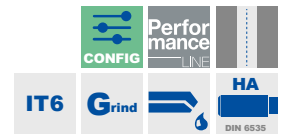
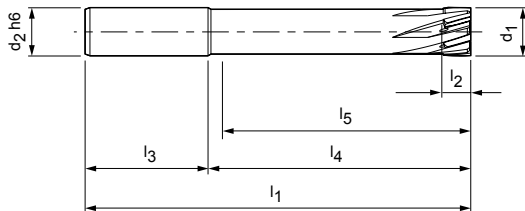

Konfigurierbare Merkmale



Bohrungsdurchmesser Toleranz \geq IT6:

- Durchmesser in Abstufungen von 0,001 mm frei wählbar
- In Toleranz \geq IT6 bestellbar

Spezifikation:

MOR710Ø[Durchmesser][Toleranz]MY1G-HP421

G-Variante:

- Durchmesser in Abstufungen von 0,001 mm frei wählbar
- Ab Toleranz \geq 4 μ m bestellbar (G-Variante siehe Seite 355)

Spezifikation G-Variante:

MOR710GØ[Durchmesser][Toleranz]MY1G-HP421

Abmessungen konfigurierbare Baureihe IT6

d_1	d_2	l_1	l_2	l_3	l_4	l_5	z
7,700 - 9,700	12	120	8	45	75	70	4
9,701 - 11,700	12	120	8	45	75	70	6
11,701 - 17,200	16	140	8	48	92	87	6
17,201 - 22,200	20	160	12	50	110	105	6
22,201 - 27,200	20	180	12	50	130	125	6
27,201 - 29,200	25	200	12	56	144	139	6
29,201 - 40,200	25	200	12	56	144	139	8

Beispiel Toleranz IT6:

MOR710Ø16.350H6MY1G-HP421

Bohrungsdurchmesser $d_1 = 16,350$ H6

Beispiel G-Variante:

MOR710GØ16.350-4MY1G-HP421

Spezieller Werkzeugdurchmesser $d_1 = 16,350 -4 \mu$ m

MonoReam

Dehnbare Ausführung, für Durchgangsbohrung
MOR700

Ausführung:

Reibahldurchmesser: 7,700 - 40,200 mm
 Anschnitt: MY1G
 Schneidstoff: HU612
 Hartmetall
 unbeschichtet

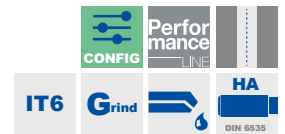
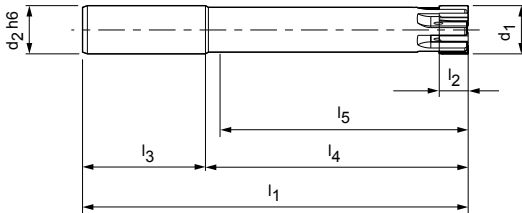

Konfigurierbare Merkmale



Bohrungsdurchmesser Toleranz \geq IT6:
 - Durchmesser in Abstufungen von 0,001 mm frei wählbar
 - In Toleranz \geq IT6 bestellbar

Spezifikation:
 MOR700Ø[Durchmesser][Toleranz]MY1G-HU612

G-Variante:
 - Durchmesser in Abstufungen von 0,001 mm frei wählbar
 - Ab Toleranz \geq 3 μ m bestellbar (G-Variante siehe Seite 355)

Spezifikation G-Variante:
 MOR700GØ[Durchmesser][Toleranz]MY1G-HU612

Abmessungen konfigurierbare Baureihe IT6

d_1	d_2	l_1	l_2	l_3	l_4	l_5	z
7,700 - 9,700	12	120	8	45	75	70	4
9,701 - 11,700	12	120	8	45	75	70	6
11,701 - 17,200	16	140	8	48	92	87	6
17,201 - 22,200	20	160	12	50	110	105	6
22,201 - 27,200	20	180	12	50	130	125	6
27,201 - 29,200	25	200	12	56	144	139	6
29,201 - 40,200	25	200	12	56	144	139	8

Beispiel Toleranz IT6:
 MOR700Ø16.350H6MY1G-HU612

Bohrungsdurchmesser $d_1 = 16,350$ H6

Beispiel G-Variante:
 MOR700GØ16.350-3MY1G-HU612

Spezieller Werkzeugdurchmesser $d_1 = 16,350 -3 \mu$ m

MonoReam

Dehbare Ausführung, gerade genutet, für Grundbohrung
MOR705

Ausführung:

Reibahldurchmesser: 7,700 - 40,200 mm
Anschnitt: MU2A
Schneidstoff: CU130
Cermet unbeschichtet

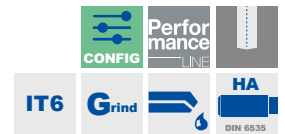
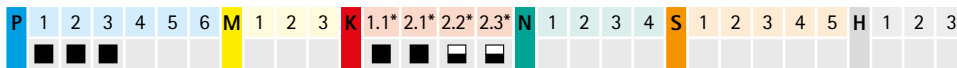
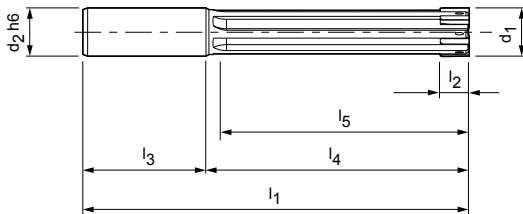

Konfigurierbare Merkmale



Bohrungsdurchmesser Toleranz \geq IT6:

- Durchmesser in Abstufungen von 0,001 mm frei wählbar
- In Toleranz \geq IT6 bestellbar

Spezifikation:

MOR705Ø[Durchmesser][Toleranz]MU2A-CU130

G-Variante:

- Durchmesser in Abstufungen von 0,001 mm frei wählbar
- Ab Toleranz \geq 3 μ m bestellbar (G-Variante siehe Seite 355)

Spezifikation G-Variante:

MOR705GØ[Durchmesser][Toleranz]MU2A-CU130

Abmessungen konfigurierbare Baureihe IT6

d_1	d_2	l_1	l_2	l_3	l_4	l_5	z
7,700 - 9,700	12	120	8	45	75	64	4
9,701 - 11,700	12	120	8	45	75	65	6
11,701 - 17,200	16	140	8	48	92	80	6
17,201 - 18,200	20	160	12	50	110	98	6
18,201 - 19,200	20	160	12	50	110	99	6
19,201 - 22,200	20	160	12	50	110	100	6
22,201 - 27,200	20	180	12	50	130	120	6
27,201 - 29,200	25	200	12	56	144	130	6
29,201 - 40,200	25	200	12	56	144	130	8

Beispiel Toleranz IT6:

MOR705Ø16.350H6MU2A-CU130

Bohrungsdurchmesser $d_1 = 16,350$ H6

Beispiel G-Variante:

MOR705GØ16.350-3MU2A-CU130

Spezieller Werkzeugdurchmesser $d_1 = 16,350 -3 \mu$ m

Maßangaben in mm.

* für Oberflächen $R_a < 2 \mu$ m

Schnittwertempfehlung siehe Kapitelende.

MonoReam

Dehnbare Ausführung, gerade genutet, für Grundbohrung MOR705

Ausführung:

Reibahldurchmesser: 7,700 - 40,200 mm
 Anschnitt: MU2A
 Schneidstoff: HP421
 Hartmetall
 PVD-beschichtet

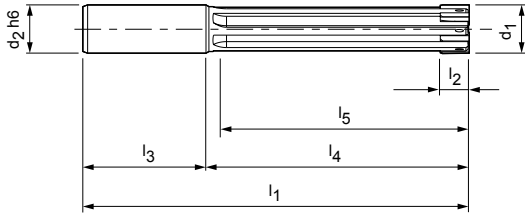

P
1
2
3.1
3.2
3.3
4
5
6
M
1
2
3
K
1
2
3
N
1
2
3
4
S
1
2
3
4
5
H
1
2
3

Konfigurierbare Merkmale

Bohrungsdurchmesser Toleranz ≥ IT6:

- Durchmesser in Abstufungen von 0,001 mm frei wählbar
- In Toleranz ≥ IT6 bestellbar

Spezifikation:
 MOR705Ø[Durchmesser][Toleranz]MU2A-HP421

G-Variante:

- Durchmesser in Abstufungen von 0,001 mm frei wählbar
- Ab Toleranz ≥ 4 µm bestellbar (G-Variante siehe Seite 355)

Spezifikation G-Variante:
 MOR705GØ[Durchmesser][Toleranz]MU2A-HP421

Abmessungen konfigurierbare Baureihe IT6

d ₁	d ₂	l ₁	l ₂	l ₃	l ₄	l ₅	z
7,700 - 9,700	12	120	8	45	75	64	4
9,701 - 11,700	12	120	8	45	75	65	6
11,701 - 17,200	16	140	8	48	92	80	6
17,201 - 18,200	20	160	12	50	110	98	6
18,201 - 19,200	20	160	12	50	110	99	6
19,201 - 22,200	20	160	12	50	110	100	6
22,201 - 27,200	20	180	12	50	130	120	6
27,201 - 29,200	25	200	12	56	144	130	6
29,201 - 40,200	25	200	12	56	144	130	8

Beispiel Toleranz IT6:
 MOR705Ø16.350H6MU2A-HP421

Bohrungsdurchmesser d₁ = 16,350 H6

Beispiel G-Variante:
 MOR705GØ16.350-4MU2A-HP421

Spezieller Werkzeugdurchmesser d₁ = 16,350 -4 µm

MonoReam

Dehbare Ausführung, gerade genutet, für Grundbohrung
MOR705

Ausführung:

Reibahldurchmesser: 7,700 - 40,200 mm
Anschnitt: MU2A
Schneidstoff: HU612
Hartmetall
unbeschichtet

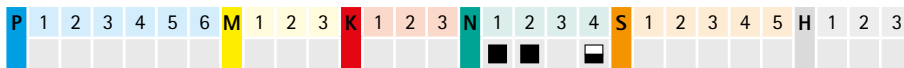
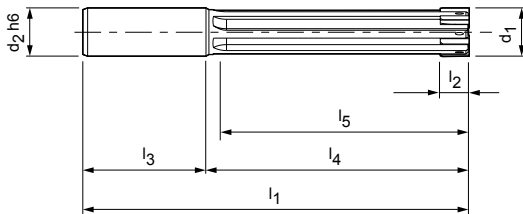

Konfigurierbare Merkmale



Bohrungsdurchmesser Toleranz \geq IT6:

- Durchmesser in Abstufungen von 0,001 mm frei wählbar
- In Toleranz \geq IT6 bestellbar

Spezifikation:

MOR705Ø[Durchmesser][Toleranz]MU2A-HU612

G-Variante:

- Durchmesser in Abstufungen von 0,001 mm frei wählbar
- Ab Toleranz \geq 3 μ m bestellbar (G-Variante siehe Seite 355)

Spezifikation G-Variante:

MOR705GØ[Durchmesser][Toleranz]MU2A-HU612

Abmessungen konfigurierbare Baureihe IT6

d_1	d_2	l_1	l_2	l_3	l_4	l_5	z
7,700 - 9,700	12	120	8	45	75	64	4
9,701 - 11,700	12	120	8	45	75	65	6
11,701 - 17,200	16	140	8	48	92	80	6
17,201 - 18,200	20	160	12	50	110	98	6
18,201 - 19,200	20	160	12	50	110	99	6
19,201 - 22,200	20	160	12	50	110	100	6
22,201 - 27,200	20	180	12	50	130	120	6
27,201 - 29,200	25	200	12	56	144	130	6
29,201 - 40,200	25	200	12	56	144	130	8

Beispiel Toleranz IT6:

MOR705Ø16.350H6MU2A-HU612

Bohrungsdurchmesser $d_1 = 16,350$ H6

Beispiel G-Variante:

MOR705GØ16.350-3MU2A-HU612

Spezieller Werkzeugdurchmesser $d_1 = 16,350 -3 \mu$ m

MonoReam Plus

Feste Ausführung, für Durchgangsbohrung
MRP510

Ausführung:

Reibahldurchmesser: 3,850 - 8,200 mm
 Anschnitt: MG1M
 Schneidstoff: CU178
 Cermet unbeschichtet

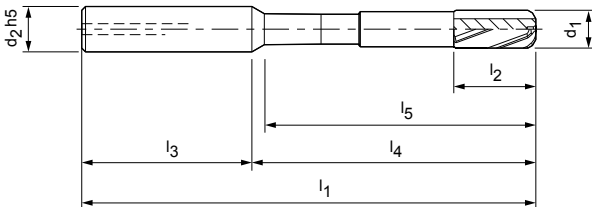

Konfigurierbare Merkmale



Bohrungsdurchmesser Toleranz \geq IT6:

- Durchmesser in Abstufungen von 0,001 mm frei wählbar
- In Toleranz \geq IT6 bestellbar

Spezifikation:

MRP510Ø[Durchmesser][Toleranz]MG1M-CU178

G-Variante:

- Durchmesser in Abstufungen von 0,001 mm frei wählbar
- Ab Toleranz \geq 3 μ m bestellbar (G-Variante siehe Seite 355)

Spezifikation G-Variante:

MRP510GØ[Durchmesser][Toleranz]MG1M-CU178

Abmessungen konfigurierbare Baureihe IT6

d ₁	d ₂	l ₁	l ₂	l ₃	l ₄	l ₅	z
3,850 - 4,900	10	80	14	40	40	33	4
4,901 - 6,200	12	85	14	45	40	33	4
6,201 - 6,700	12	105	14	45	60	52	6
6,701 - 8,200	12	110	18	45	65	57	6

Beispiel Toleranz IT6:

MRP510Ø5.350H6MG1M-CU178

Bohrungsdurchmesser d₁ = 5,350 mm H6

Beispiel G-Variante:

MRP510GØ5.350-3MG1M-CU178

Spezieller Werkzeugdurchmesser d₁ = 5,350 -3 μ m

Maßangaben in mm.

* für Oberflächen R_a < 2 μ m

Schnittwertempfehlung siehe Kapitelende.

MonoReam Plus

Feste Ausführung, für Durchgangsbohrung
MRP505

Ausführung:

Reibahldurchmesser: 3,850 - 8,200 mm
Anschnitt: MV3C
Schneidstoff: CU178
Cermet unbeschichtet

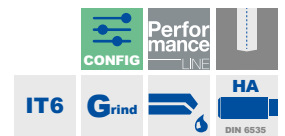
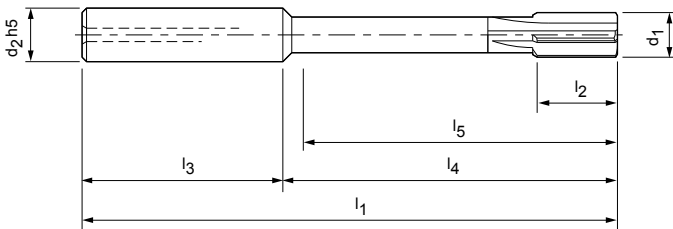

Konfigurierbare Merkmale

Bohrungsdurchmesser Toleranz \geq IT6:

- Durchmesser in Abstufungen von 0,001 mm frei wählbar
- In Toleranz \geq IT6 bestellbar

Spezifikation:

MRP505Ø[Durchmesser][Toleranz]MV3C-CU178

G-Variante:

- Durchmesser in Abstufungen von 0,001 mm frei wählbar
- Ab Toleranz \geq 3 μ m bestellbar (G-Variante siehe Seite 355)

Spezifikation G-Variante:

MRP505GØ[Durchmesser][Toleranz]MV3C-CU178

Abmessungen konfigurierbare Baureihe IT6

d_1	d_2	l_1	l_2	l_3	l_4	l_5	z
3,850 - 4,900	10	80	12	40	40	33	4
4,901 - 6,200	12	85	12	45	40	33	4
6,201 - 6,700	12	105	12	45	60	53	6
6,701 - 8,200	12	110	16	45	65	58	6

Beispiel Toleranz IT6:

MRP505Ø5.350H6MV3C-CU178

Bohrungsdurchmesser $d_1 = 5,350$ mm H6

Beispiel G-Variante:

MRP505Ø5.350-3MV3C-CU178

Spezieller Werkzeugdurchmesser $d_1 = 5,350$ -3 μ m

Maßangaben in mm.

* für Oberflächen $R_a < 2$ μ m

Schnittwertempfehlung siehe Kapitelende.

Schnittwertempfehlung für MonoReam MOR | MonoReam Plus MRP

Vorschub und Schnittgeschwindigkeit

MRP505 | MRP510

Schneidstoff: CU178 | Anschnitt: MV3C | MG1M

MZG*	Werkstoff	Festigkeit/Härte [N/mm ²] [HRC]	Schnittgeschwindigkeit v _c (m/min)			
			Innenkühlung	Außenkühlung	MMS	
P	P1	P1.1 Bau-, Automaten-, Einsatz- und Vergütungsstähle, unlegiert	< 700	150	75	125
		P1.2 Bau-, Automaten-, Einsatz- und Vergütungsstähle, unlegiert	< 1200	150	75	125
	P2	P2.1 Nitrier-, Einsatz- und Vergütungsstähle, legiert	< 900	130	65	110
		P2.2 Nitrier-, Einsatz- und Vergütungsstähle, legiert	< 1400	130	65	110
	P3	P3.1 Werkzeug-, Wälzlager-, Feder- und Schnellarbeitsstähle**	< 800	130	65	110
		P3.2 Werkzeug-, Wälzlager-, Feder- und Schnellarbeitsstähle**	< 1000	120	60	100
P3.3 Werkzeug-, Wälzlager-, Feder- und Schnellarbeitsstähle**		< 1500				

MOR705 | MOR710

Schneidstoff: CU130 | Anschnitt: MU2A | MY1G

MZG*	Werkstoff	Festigkeit/Härte [N/mm ²] [HRC]	Schnittgeschwindigkeit v _c (m/min)			
			Innenkühlung	Außenkühlung	MMS	
P	P1	P1.1 Bau-, Automaten-, Einsatz- und Vergütungsstähle, unlegiert	< 700	150	75	125
		P1.2 Bau-, Automaten-, Einsatz- und Vergütungsstähle, unlegiert	< 1200	150	75	125
	P2	P2.1 Nitrier-, Einsatz- und Vergütungsstähle, legiert	< 900	130	65	110
		P2.2 Nitrier-, Einsatz- und Vergütungsstähle, legiert	< 1400	130	65	110
	P3	P3.1 Werkzeug-, Wälzlager-, Feder- und Schnellarbeitsstähle**	< 800	130	65	110
		P3.2 Werkzeug-, Wälzlager-, Feder- und Schnellarbeitsstähle**	< 1000	120	60	100
P3.3 Werkzeug-, Wälzlager-, Feder- und Schnellarbeitsstähle**		< 1500				
K	K1	K1.1 Gusseisen mit Lamellengraphit (Grauguss), GJL	< 300	120	100	100
		K2.1 Gusseisen mit Kugelgraphit, GJS	< 500	120	85	105
	K2	K2.2 Gusseisen mit Kugelgraphit, GJS	≤ 800			
		K2.3 Gusseisen mit Kugelgraphit, GJS	> 800			

MOR705 | MOR710

Schneidstoff: HP421 | Anschnitt: MU2A | MY1G

MZG*	Werkstoff	Festigkeit/Härte [N/mm ²] [HRC]	Schnittgeschwindigkeit v _c (m/min)			
			Innenkühlung	Außenkühlung	MMS	
P	P3	P3.1 Werkzeug-, Wälzlager-, Feder- und Schnellarbeitsstähle**	< 800			
		P3.2 Werkzeug-, Wälzlager-, Feder- und Schnellarbeitsstähle**	< 1000			
		P3.3 Werkzeug-, Wälzlager-, Feder- und Schnellarbeitsstähle**	< 1500	100	50	75
	P4	P4.1 Rostfreie Stähle, ferritisch und martensitisch		40	20	30
	P5	P5.1 Stahlguss		110	60	80
	P6	P6.1 Rostfreier Stahlguss, ferritisch und martensitisch		40	20	30
K	K1	K1.1 Gusseisen mit Lamellengraphit (Grauguss), GJL	< 300	120	100	100
		K2.1 Gusseisen mit Kugelgraphit, GJS	< 500	110	80	95
	K2	K2.2 Gusseisen mit Kugelgraphit, GJS	≤ 800	90	65	75
		K2.3 Gusseisen mit Kugelgraphit, GJS	> 800	90	55	70
	K3	K3.1 Gusseisen mit Vermiculargraphit, GJV; Temperguss, GJM	< 500	90	55	70
		K3.2 Gusseisen mit Vermiculargraphit, GJV; Temperguss, GJM	> 500	90	55	70

* MAPAL Zerspanungsgruppen

** Wenn die Legierungsbestandteile Cr, Mo, Ni, V, W in Summe > 8 %, dann die nächst höhere MAPAL Zerspanungsgruppe wählen.

Vorschub f_z (mm/U) bei Werkzeugdurchmesser			
	z 4	z 4	z 6
	< 5,000	5,000 - 6,200	> 6,200 - 8,200
	0,025	0,040	0,060
	0,025	0,040	0,060
	0,025	0,040	0,060
	0,025	0,040	0,060
	0,025	0,040	0,060
	0,025	0,040	0,060

Vorschub f_z (mm/U) bei Werkzeugdurchmesser				
	z 4	z 6	z 6	z 8
	8,000 - 9,700	> 9,700 - 16,000	> 16,000 - 29,200	> 29,200 - 40,200
	0,100	0,150	0,150	0,150
	0,100	0,150	0,150	0,150
	0,100	0,150	0,150	0,150
	0,080	0,120	0,120	0,120
	0,100	0,150	0,150	0,150
	0,100	0,150	0,150	0,150
	0,150	0,200	0,200	0,250
	0,150	0,180	0,180	0,180

Vorschub f_z (mm/U) bei Werkzeugdurchmesser				
	z 4	z 6	z 6	z 8
	8,000 - 9,700	> 9,700 - 16,000	> 16,000 - 29,200	> 29,200 - 40,200
	0,100	0,150	0,150	0,150
	0,080	0,100	0,120	0,120
	0,150	0,150	0,150	0,150
	0,080	0,100	0,120	0,120
	0,150	0,200	0,200	0,250
	0,150	0,180	0,180	0,180
	0,150	0,180	0,180	0,180
	0,120	0,150	0,150	0,150
	0,150	0,180	0,180	0,180
	0,150	0,150	0,150	0,150

Die angegebenen Schnittwerte sind Richtwerte.

Die für den jeweiligen Bearbeitungsfall optimalen Daten sollten im Versuch oder während der Bearbeitung ermittelt werden.

Schnittwertempfehlung für MonoReam MOR

Vorschub und Schnittgeschwindigkeit

MOR700

Schneidstoff: HU612 | Anschnitt: MY1G

MZG*	Werkstoff	Festigkeit/Härte [N/mm ²] [HRC]	Schnittgeschwindigkeit v _c (m/min)		
			Innenkühlung	Außenkühlung	MMS
N1	N1.1 Aluminium, unlegiert und legiert < 3 % Si		50	25	40
	N1.2 Aluminium, legiert ≤ 7 % Si		50	25	40
	N1.3 Aluminium, legiert > 7-12 % Si		30	15	25
	N1.4 Aluminium, legiert > 12 % Si		30	15	25
N2	N2.1 Kupfer, unlegiert und niedriglegiert	< 300	50	25	
	N2.2 Kupfer, legiert	> 300	50	25	
	N2.3 Messing, Bronze, Rotguss	< 1200	50	25	40
N4	N4.1 Kunststoff, Thermoplaste		40	20	
	N4.2 Kunststoff, Duroplaste		40	20	
	N4.3 Kunststoff, Schaumstoffe		40	20	

MOR705

Schneidstoff: HU612 | Anschnitt: MU2A

MZG*	Werkstoff	Festigkeit/Härte [N/mm ²] [HRC]	Schnittgeschwindigkeit v _c (m/min)		
			Innenkühlung	Außenkühlung	MMS
N1	N1.1 Aluminium, unlegiert und legiert < 3 % Si		50	25	40
	N1.2 Aluminium, legiert ≤ 7 % Si		50	25	40
	N1.3 Aluminium, legiert > 7-12 % Si		30	15	25
	N1.4 Aluminium, legiert > 12 % Si		30	15	25
N2	N2.1 Kupfer, unlegiert und niedriglegiert	< 300	50	25	
	N2.2 Kupfer, legiert	> 300	50	25	
	N2.3 Messing, Bronze, Rotguss	< 1200	50	25	40

	Vorschub f_z (mm/U) bei Werkzeugdurchmesser			
	z 4	z 6	z 6	z 8
	8,000 - 9,700	> 9,700 - 16,000	> 16,000 - 29,200	> 29,200 - 40,200
	0,050	0,080	0,100	0,120
	0,050	0,080	0,100	0,120
	0,050	0,080	0,100	0,120
	0,050	0,080	0,100	0,120
	0,050	0,080	0,100	0,120
	0,050	0,080	0,100	0,120
	0,050	0,080	0,100	0,120
	0,050	0,080	0,080	0,080
	0,050	0,080	0,080	0,080
	0,050	0,080	0,080	0,080

	Vorschub f_z (mm/U) bei Werkzeugdurchmesser			
	z 4	z 6	z 6	z 8
	8,000 - 9,700	> 9,700 - 16,000	> 16,000 - 29,200	> 29,200 - 40,200
	0,050	0,080	0,100	0,120
	0,050	0,080	0,100	0,120
	0,050	0,080	0,100	0,120
	0,050	0,080	0,100	0,120
	0,050	0,080	0,100	0,120
	0,050	0,080	0,100	0,120
	0,050	0,080	0,100	0,120

Die angegebenen Schnittwerte sind Richtwerte.

Die für den jeweiligen Bearbeitungsfall optimalen Daten sollten im Versuch oder während der Bearbeitung ermittelt werden.

PRODUKTÜBERSICHT

HPR-Wechselkopfreibahle

Das HPR-Programm an Wechselkopfreibahnen umfasst Baureihen für Durchgangs- und Grundbohrungen ab einem Durchmesser von 7,00 mm. Die Wechselkopfreibahnen sind entweder als feste Ausführung (Baureihe XX) oder als feinjustierbare Ausführung (Baureihe XX) verfügbar und können mit verschiedenen Schneidstoffen wie Hartmetall oder Cermet bestückt werden. Die Reibahnen lassen sich im Durchmesserbereich von 7,00 bis 65,00 mm in μm -Schritten und im Toleranzbereich \geq IT5 konfigurieren. Als Vorzugsbaureihe ist ein breites Programm an H7-Abmessungen verfügbar.

Die zugehörigen Halter zeichnen sich mit dem Head Fitting System (HFS) durch exakte Rundlauf- und Wechselgenauigkeit kleiner als $3 \mu\text{m}$ und sicheres, einfaches Handling, besonders beim Montieren und Demontieren des Werkzeugkopfes aus. HFS garantiert hohe Präzision und Leistungsübertragung. Durch den einfachen Aufbau mit direkter Kühlmittelführung bis an die Schneide ist das System für Minimalmengenschmierung (MMS) bedingt geeignet.

HPR feste Ausführung



HPR Baureihe 100 | 130 | 131 | 110 | 150 | 180

Feste Ausführung mit gelöteten Schneiden.

Ø-Bereich: 7,000 – 65,000 mm*

Perfor
mance
LINE



P M K N S



HPR feinjustierbare Ausführung



HPR Baureihe 200 | 230 | 231 | 210 | 250 | 280

Durch Justiersystem μm -genau einstellbar.



\varnothing -Bereich: 7,000 – 65,000 mm*

Expert
LINE



P M K N S

Auswahlübersicht HPR (1/2)

Bohrungs- Art	Materialeignung																
	P								M	K					N	S	
	1	2	3.1	3.2	3.3	4	5	6	1-3	1	2.1	2.2	2.3	3	1-2	1-5	
	<input checked="" type="checkbox"/>	<input checked="" type="checkbox"/>	<input checked="" type="checkbox"/>	<input type="checkbox"/>	<input type="checkbox"/>					<input type="checkbox"/>	<input type="checkbox"/>						
	<input checked="" type="checkbox"/>	<input checked="" type="checkbox"/>	<input checked="" type="checkbox"/>	<input type="checkbox"/>	<input type="checkbox"/>					<input type="checkbox"/>	<input type="checkbox"/>						
	<input type="checkbox"/>	<input type="checkbox"/>	<input type="checkbox"/>	<input checked="" type="checkbox"/>	<input checked="" type="checkbox"/>	<input type="checkbox"/>	<input checked="" type="checkbox"/>										
	<input type="checkbox"/>	<input type="checkbox"/>	<input type="checkbox"/>	<input checked="" type="checkbox"/>	<input checked="" type="checkbox"/>	<input type="checkbox"/>	<input checked="" type="checkbox"/>										
						<input checked="" type="checkbox"/>		<input checked="" type="checkbox"/>	<input checked="" type="checkbox"/>								
						<input checked="" type="checkbox"/>		<input checked="" type="checkbox"/>	<input checked="" type="checkbox"/>		<input checked="" type="checkbox"/>	<input checked="" type="checkbox"/>					
										<input checked="" type="checkbox"/>	<input checked="" type="checkbox"/>						
										<input checked="" type="checkbox"/>	<input checked="" type="checkbox"/>						
										<input checked="" type="checkbox"/>	<input checked="" type="checkbox"/>						
										<input checked="" type="checkbox"/>	<input checked="" type="checkbox"/>						
										<input checked="" type="checkbox"/>	<input checked="" type="checkbox"/>	<input type="checkbox"/>	<input type="checkbox"/>	<input type="checkbox"/>			
										<input checked="" type="checkbox"/>	<input checked="" type="checkbox"/>	<input checked="" type="checkbox"/>	<input checked="" type="checkbox"/>	<input checked="" type="checkbox"/>			
										<input checked="" type="checkbox"/>	<input checked="" type="checkbox"/>	<input checked="" type="checkbox"/>	<input checked="" type="checkbox"/>	<input checked="" type="checkbox"/>			
															<input checked="" type="checkbox"/>		
															<input checked="" type="checkbox"/>		
																<input checked="" type="checkbox"/>	

Schritt 1:
BohrungsartSchritt 2:
MaterialeignungSchritt 3:
AusführungSchritt 4:
ProduktklasseSchritt 5:
Vorkonfigurierte Durchmesser oder Konfiguration

	Ausführung			Vorkonfigurierte Durchmesser				Konfiguration
	d1	Schneidstoff	Anschnitt	Perfor- mance LINE	Feste Baureihe	Expert LINE	Fein- justierbare Baureihe	
				Baureihe	Seite	Baureihe	Seite	
	7,000 - 18,590	CU134	ME1G	HPR131	379	HPR231	418	HPR131 HPR231
	15,600 - 65,000	CU134	ME1G	HPR110	390	HPR210	426	
	7,000 - 18,590	HP421	ME1G	HPR131	380	HPR231	419	
	15,600 - 65,000	HP421	ME1G	HPR110	392	HPR210	427	
	7,000 - 18,590	HP421	MF1G	HPR131	381	HPR231	420	
	15,600 - 65,000	HP421	MF1G	HPR110	394	HPR210	428	
	7,000 - 18,590	CP134	MC1G	HPR130	374	HPR230	414	
	15,600 - 65,000	CP134	MC1G	HPR100	383	HPR200	422	
	7,000 - 18,590	HC419	MC1G	HPR130	375			
	15,600 - 65,000	HC419	MC1G	HPR100	384			
	7,000 - 18,590	HP421	MC1G	HPR130	376	HPR230	415	
	15,600 - 65,000	HP421	MC1G	HPR100	386	HPR200	423	
	7,000 - 18,590	HP423	MC1G	HPR130	377	HPR230	416	
	15,600 - 65,000	HP423	MC1G	HPR100	388	HPR200	424	
	7,000 - 18,590	PU620	MA0A	HPR130	378	HPR230	417	
	15,600 - 65,000	PU620	MA0A	HPR100	389	HPR200	425	
	7,000 - 18,590	HP625	MF1G	HPR131	382	HPR231	421	
	15,600 - 65,000	HP625	MF1G	HPR110	393	HPR210	431	
	7,000 - 21,290	CU134	ML2G	HPR180	396	HPR280	430	HPR180 HPR280
	16,600 - 65,000	CU134	ML2G	HPR150	405	HPR250	438	
	7,000 - 21,290	HP421	ML2G	HPR180	397	HPR280	431	
	16,600 - 65,000	HP421	ML2G	HPR150	406	HPR250	439	
	7,000 - 21,290	HP421	MO2G	HPR180	398	HPR280	432	
	16,600 - 65,000	HP421	MO2G	HPR150	407	HPR250	440	
	7,000 - 21,290	CP134	MC1G	HPR180	399	HPR280	433	
	16,600 - 65,000	CP134	MC1G	HPR150	408	HPR250	441	
	7,000 - 21,290	HC419	MC1G	HPR180	400			
	16,600 - 65,000	HC419	MC1G	HPR150	403			
	7,000 - 21,290	HP421	MC1G	HPR180	401	HPR280	434	
	16,600 - 65,000	HP421	MC1G	HPR150	410	HPR250	442	
	7,000 - 21,290	HP423	MC1G	HPR180	402	HPR280	435	
	16,600 - 65,000	HP423	MC1G	HPR150	411	HPR250	443	
	7,000 - 21,290	PU620	MA0A	HPR180	403	HPR280	436	
	16,600 - 65,000	PU620	MA0A	HPR150	412	HPR250	444	
	7,000 - 21,290	HP625	MO2G	HPR180	404	HPR280	437	
	16,600 - 65,000	HP625	MO2G	HPR150	413	HPR250	445	

Baureihenkonfiguration auf nächster Seite.

Auswahlübersicht HPR | Konfiguration (2/2)

HPR131 | HPR231

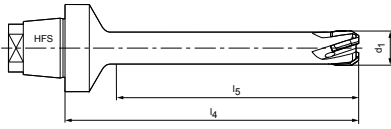

HPR130 | HPR230

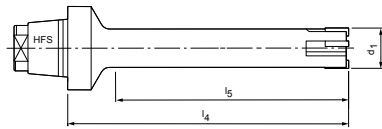

HPR180 | HPR280

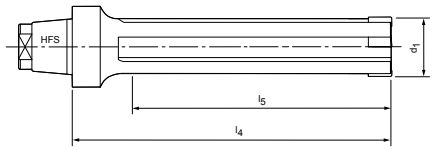

Werkzeugabmessungen

	ød ₁	l ₄	l ₅	HFS-Größe	z
HPR130 131 HPR230 231	7,000 - 9,590	60	45	12	4
	9,600 - 18,590	60	45	12	6
HPR180 HPR280	7,000 - 14,590	60	40	12	4
	14,600 - 21,290	60	40	12	6
HPR100 HPR110	15,600 - 18,590	14	-	10	6
	18,600 - 21,290	14,5	-	12	6
	21,300 - 23,990	15,5	-	14	6
	24,000 - 29,990	16	-	16	6
	30,000 - 39,990	17	-	20	8
	40,000 - 50,700	19	-	24	8
HPR150	50,710 - 65,000	25	-	24	8
	16,600 - 21,290	14	-	10	6
	21,300 - 24,990	15,5	-	12	6
	25,000 - 28,990	15,5	-	14	6
	29,000 - 36,990	17	-	16	6
	37,000 - 44,990	17	-	20	8
	45,000 - 50,700	19	-	24	8
	50,710 - 65,000	25	-	24	8

	ød ₁	l ₄	l ₅	HFS-Größe	z
HPR200 HPR210	18,600 - 20,390	25	-	12	6
	20,400 - 21,290	27	-	12	6
	21,300 - 23,990	27	-	14	6
	24,000 - 29,990	35	-	16	6
	30,000 - 39,990	41	-	20	8
	40,000 - 65,000	47	-	24	8
HPR250	16,600 - 21,290	25	-	10	6
	21,300 - 24,990	27	-	12	6
	25,000 - 28,590	35	-	14	6
	29,000 - 32,290	35	-	16	6
	32,300 - 36,990	41	-	16	6
	37,000 - 41,190	41	-	20	8
	41,200 - 44,900	47	-	20	8
	45,000 - 65,000	47	-	24	8

Bestellbeispiel:

Baureihe

H P R

HPR-Wechselkopfreibahle

1 0 0

Ausführungen:
1 = Feste Reibahle
2 = Feinjustierbare Reibahle

Durchmesser

G

Schrägungswinkel der Schneiden:

0 = Gerade genutet bis ø 65,000 mm
1 = Linksschräg genutet bis ø 65,000 mm
3 = Linksschräg bis ø 18,590 mm
5 = Grundbohrung bis ø 65,000 mm
8 = Grundbohrung bis ø 21,290 mm

ø 2 0 . 0 0 0

Bohrungs- oder Werkzeugdurchmesser

G = Angabe Werkzeugdurchmesser
Stelle wird nur bei C- und G-Varianten belegt

Toleranz

- 5

IT oder Abmaße in µm (Beispiel: +30+10) oder bei G-Variante Angabe der Fertigungstoleranz des Werkzeugschleifdurchmessers zum Beispiel -3µm

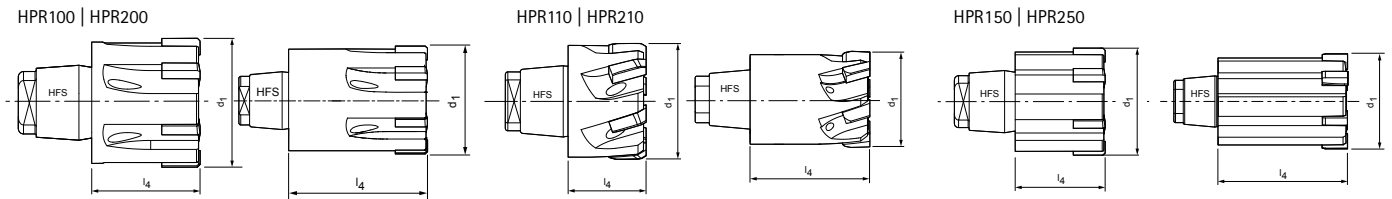

Zulässige Werkstücktoleranzen zur Auswahl des Werkzeugdurchmessers:

Feste Ausführung:

IT6 (16µm) über $\geq \varnothing 30,000$ HPR

Sollte die Toleranz kleiner des zu bearbeitende Werkstückdurchmesser sein wie die oben genannte Toleranzklasse, kann ein feinjustierbare Ausführung oder eine feste Ausführung als G-Variante (spezieller Werkzeugdurchmesser) gewählt werden.

Feinjustierbare Ausführung:

IT5 (11µm) über $\geq \varnothing 30,000$ HPR

Sollte die Toleranz kleiner des zu bearbeitende Werkstückdurchmesser sein wie die oben genannte Toleranzklasse, kann ein feinjustierbare Ausführung als G-Variante (spezieller Werkzeugdurchmesser) gewählt werden.

Ausführung G-Variante

Die G-Variante gibt dann den Werkzeugdurchmesser der Reibahle mit unseren Fertigungstoleranzen an.

Toleranzen für die G-Variante/feste Variante HPR1XX:

Schneidstoff	Durchmesserbereich	
	$\varnothing 7 - < \varnothing 60$	$\geq \varnothing 60 - \varnothing 65$
Unbeschichtet		
HU612		
CU134	-0,003	-0,006
CU130		
PU620		
Beschichtet (Schichtdicke 1 - 2 µm)		
HP421	-0,005	-0,008
CP134		
Beschichtet (Schichtdicke 2 - 4 µm)		
HP423		
HP463	-0,007	-0,010
CP132		
CP233		
Beschichtet (Schichtdicke 3 - 5 µm)		
HC412		
HC413	-0,007	-0,010
HC419		
HP612		

Toleranzen für die G-Variante/feinjustierbare Variante HPR2XX: generell Einstellmaß +/-0,001

Anschnitt [Lead]

M C 1 G

Anschnittform und Spanwinkel:

Spanwinkel:

MC1G	ME1G	Erklärung der Anschnittgeometrien siehe Seite 752.
MA0A	ML2G	
MO2G	MF1G	

Schneidstoff [Cut]

H P 4 2 1

Schneidstoff:

HP421	CU134
HP422	HP625
HP423	HC419
CP134	PU620

HPR-Wechselkopfreibahle

Feste Ausführung, gerade genutet, für Durchgangsbohrung
HPR130

Ausführung:

Reibahldurchmesser: 7,000 - 18,590 mm
 Anschnitt: MC1G
 Schneidstoff: CP134
 Cermet
 PVD-beschichtet

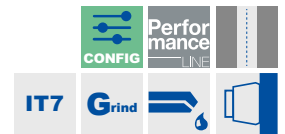
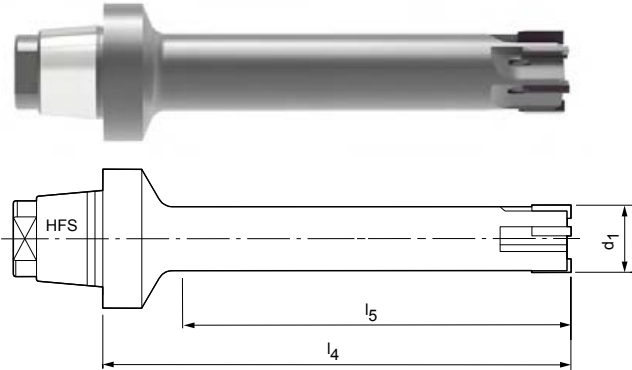

Konfigurierbare Merkmale



Bohrungsdurchmesser Toleranz IT7:

- Durchmesser in Abstufungen von 0,001 mm frei wählbar
- In Toleranz IT7 bestellbar

Spezifikation:

HPR130Ø[Durchmesser][Toleranz]MC1G-CP134

Bohrungsdurchmesser Toleranz < IT7:

- Toleranzen kleiner IT7 als spezieller Werkzeugdurchmesser bestellbar (G-Variante siehe Seite 373)

Spezifikation G-Variante:

HPR130GØ[Durchmesser][Toleranz]MC1G-CP134

Abmessungen konfigurierbare Baureihe IT7

d ₁	l ₄	l ₅	HFS-Größe	z
7,000 - 9,590	60	45	12	4
9,600 - 18,590	60	45	12	6

Beispiel Toleranz IT7:

HPR130Ø16.350H7MC1G-CP134

Bohrungsdurchmesser d₁ = 16,350 H7

Beispiel G-Variante:

HPR130GØ16.350-5MC1G-CP134

Spezieller Werkzeugdurchmesser d₁ = 16,350 -5 µm

Maßangaben in mm.

* für Oberflächen R_a < 2 µm

Zugehörige HFS-Wechselkopfhalter ab Seite 460.

Schnittwertempfehlung siehe Kapitelende.

HPR-Wechselkopfreibahle

Feste Ausführung, gerade genutet, für Durchgangsbohrung
HPR130

Ausführung:

Reibahlundurchmesser: 7,000 - 18,590 mm
Anschnitt: MC1G
Schneidstoff: HC419
Hartmetall
CVD-beschichtet

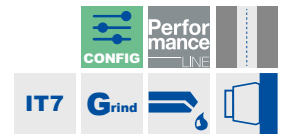
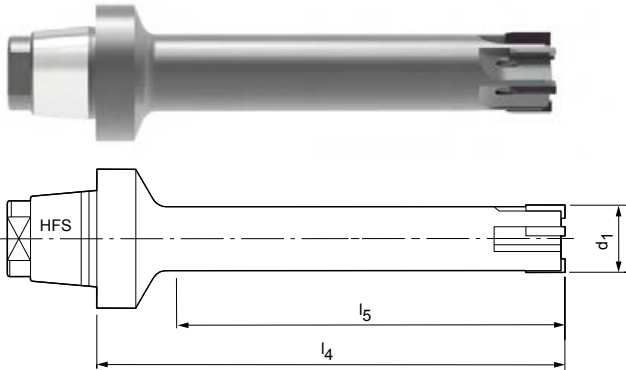

Konfigurierbare Merkmale



Bohrungsdurchmesser Toleranz IT7:

- Durchmesser in Abstufungen von 0,001 mm frei wählbar
- In Toleranz IT7 bestellbar

Spezifikation:

HPR130Ø[Durchmesser][Toleranz]MC1G-HC419

Bohrungsdurchmesser Toleranz < IT7:

- Toleranzen kleiner IT7 als spezieller Werkzeugdurchmesser bestellbar (G-Variante siehe Seite 373)

Spezifikation G-Variante:

HPR130GØ[Durchmesser][Toleranz]MC1G-HC419

Abmessungen konfigurierbare Baureihe IT7

d_1	l_4	l_5	HFS-Größe	z
7,000 - 9,590	60	45	12	4
9,600 - 18,590	60	45	12	6

Beispiel Toleranz IT7:

HPR130Ø16.350H7MC1G-HC419

Bohrungsdurchmesser $d_1 = 16,350 \text{ H7}$

Beispiel G-Variante:

HPR130GØ16.350-7MC1G-HC419

Spezieller Werkzeugdurchmesser $d_1 = 16,350 -7 \mu\text{m}$

Maßangaben in mm.

* für Oberflächen $R_a < 2 \mu\text{m}$

Zugehörige HFS-Wechselkopfhalter ab Seite 460.

Schnittwertempfehlung siehe Kapitelende.

HPR-Wechselkopffreibahle

Feste Ausführung, gerade genutet, für Durchgangsbohrung
HPR130

Ausführung:
Reibahlundurchmesser: 7,000 - 18,590 mm
Anschnitt: MC1G
Schneidstoff: HP421
Hartmetall
PVD-beschichtet

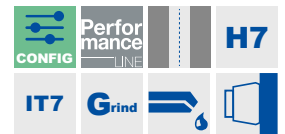
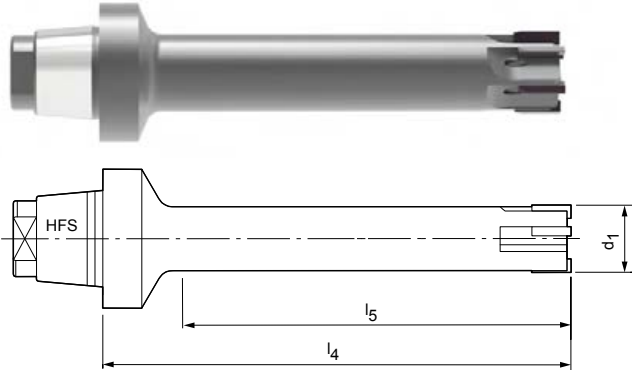

Lagerhaltige Vorzugsbaureihe in H7

d ₁ H7	HFS-Größe	Baumaße			Spezifikation	Bestell-Nr.
		l ₄	l ₅	z		
10,000	12	60	45	6	HPR130Ø10H7MC1G-HP421	30058428
12,000	12	60	45	6	HPR130Ø12H7MC1G-HP421	30201261
14,000	12	60	45	6	HPR130Ø14H7MC1G-HP421	30710146
16,000	12	60	45	6	HPR130Ø16H7MC1G-HP421	30710148
18,000	12	60	45	6	HPR130Ø18H7MC1G-HP421	30156684

Konfigurierbare Merkmale

Bohrungsdurchmesser Toleranz IT7:

- Durchmesser in Abstufungen von 0,001 mm frei wählbar
- In Toleranz IT7 bestellbar

Spezifikation:
HPR130Ø[Durchmesser][Toleranz]MC1G-HP421

Bohrungsdurchmesser Toleranz < IT7:

- Toleranzen kleiner IT7 als spezieller Werkzeugdurchmesser bestellbar (G-Variante siehe Seite 373)

Spezifikation G-Variante:
HPR130GØ[Durchmesser][Toleranz]MC1G-HP421

Abmessungen konfigurierbare Baureihe IT7

d ₁	l ₄	l ₅	HFS-Größe	z
7,000 - 9,590	60	45	12	4
9,600 - 18,590	60	45	12	6

Beispiel Toleranz IT7:
HPR130Ø16.350H7MC1G-HP421

Bohrungsdurchmesser d₁ = 16,350 H7

Beispiel G-Variante:
HPR130GØ16.350-5MC1G-HP421

Spezieller Werkzeugdurchmesser d₁ = 16,350 -5 µm

Maßangaben in mm.
Zugehörige HFS-Wechselkopfhalter ab Seite 460.
Schnittwertempfehlung siehe Kapitelende.

HPR-Wechselkopfreibahle

Feste Ausführung, gerade genutet, für Durchgangsbohrung
HPR130

Ausführung:

Reibahldurchmesser: 7,000 - 18,590 mm
Anschnitt: MC1G
Schneidstoff: HP423
Hartmetall
PVD-beschichtet

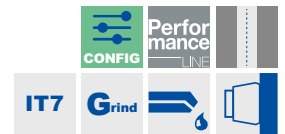
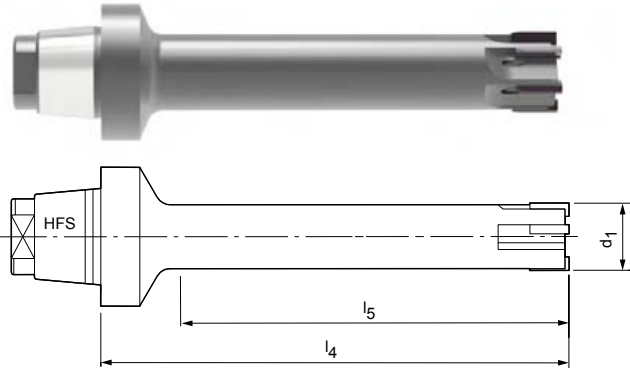

Konfigurierbare Merkmale



Bohrungsdurchmesser Toleranz IT7:

- Durchmesser in Abstufungen von 0,001 mm frei wählbar
- In Toleranz IT7 bestellbar

Spezifikation:

HPR130Ø[Durchmesser][Toleranz]MC1G-HP423

Bohrungsdurchmesser Toleranz < IT7:

- Toleranzen kleiner IT7 als spezieller Werkzeugdurchmesser bestellbar (G-Variante siehe Seite 373)

Spezifikation G-Variante:

HPR130GØ[Durchmesser][Toleranz]MC1G-HP423

Abmessungen konfigurierbare Baureihe IT7

d_1	l_4	l_5	HFS-Größe	z
7,000 - 9,590	60	45	12	4
9,600 - 18,590	60	45	12	6

Beispiel Toleranz IT7:

HPR130Ø16.350H7MC1G-HP423

Bohrungsdurchmesser $d_1 = 16,350 \text{ H7}$

Beispiel G-Variante:

HPR130GØ16.350-8MC1G-HP423

Spezieller Werkzeugdurchmesser $d_1 = 16,350 -7 \mu\text{m}$

Maßangaben in mm.

Zugehörige HFS-Wechselkopfhalter ab Seite 460.

Schnittwertempfehlung siehe Kapitelende.

HPR-Wechselkopfreibahle

Feste Ausführung, gerade genutet, für Durchgangsbohrung
HPR130

Ausführung:
Reibahlundurchmesser: 7,000 - 18,590 mm
Anschnitt: MA0A
Schneidstoff: PU620
PKD-bestückt

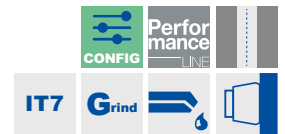
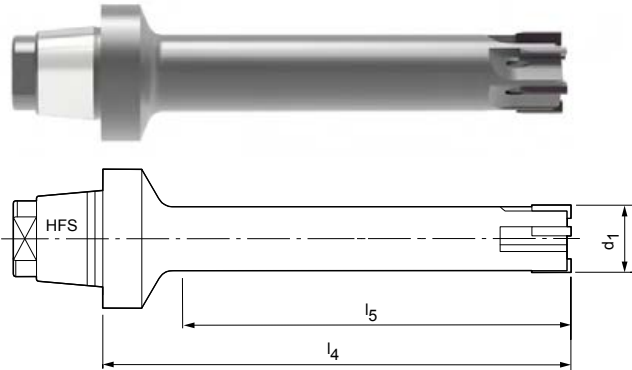

Konfigurierbare Merkmale



Bohrungsdurchmesser Toleranz IT7:

- Durchmesser in Abstufungen von 0,001 mm frei wählbar
- In Toleranz IT7 bestellbar

Spezifikation:

HPR130Ø[Durchmesser][Toleranz]MA0A-PU620

Bohrungsdurchmesser Toleranz < IT7:

- Toleranzen kleiner IT7 als spezieller Werkzeugdurchmesser bestellbar (G-Variante siehe Seite 373)

Spezifikation G-Variante:

HPR130GØ[Durchmesser][Toleranz]MA0A-PU620

Abmessungen konfigurierbare Baureihe IT7

d ₁	l ₄	l ₅	HFS-Größe	z
7,000 - 9,590	60	45	12	4
9,600 - 18,590	60	45	12	6

Beispiel Toleranz IT7:

HPR130Ø16.350H7MA0A-PU620

Bohrungsdurchmesser d₁ = 16,350 H7

Beispiel G-Variante:

HPR130GØ16.350-3MA0A-PU620

Spezieller Werkzeugdurchmesser d₁ = 16,350 -3 µm

Maßangaben in mm.

Zugehörige HFS-Wechselkopfhalter ab Seite 460.

Schnittwertempfehlung siehe Kapitelende.

HPR-Wechselkopfreibahle

Feste Ausführung, linkschräg genutet, für Durchgangsbohrung
HPR131

Ausführung:

Reibahldurchmesser: 7,000 - 18,590 mm
Anschnitt: ME1G
Schneidstoff: CU134
Cermet unbeschichtet

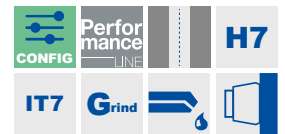
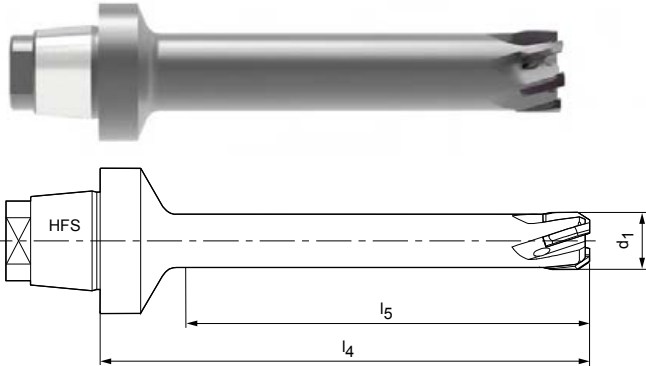

Lagerhaltige Vorzugsbaureihe in H7

d ₁ H7	HFS-Größe	Baumaße			Spezifikation	Bestell-Nr.
		l ₄	l ₅	z		
10,000	12	60	45	6	HPR131Ø10H7ME1G-CU134	30043741
11,000	12	60	45	6	HPR131Ø11H7ME1G-CU134	30087260
12,000	12	60	45	6	HPR131Ø12H7ME1G-CU134	30041656
13,000	12	60	45	6	HPR131Ø13H7ME1G-CU134	30057835
14,000	12	60	45	6	HPR131Ø14H7ME1G-CU134	30082580
16,000	12	60	45	6	HPR131Ø16H7ME1G-CU134	30047996
18,000	12	60	45	6	HPR131Ø18H7ME1G-CU134	30048997

Konfigurierbare Merkmale



Bohrungsdurchmesser Toleranz IT7:

- Durchmesser in Abstufungen von 0,001 mm frei wählbar
- In Toleranz IT7 bestellbar

Spezifikation:

HPR131Ø[Durchmesser][Toleranz]ME1G-CU134

Bohrungsdurchmesser Toleranz < IT7:

- Toleranzen kleiner IT7 als spezieller Werkzeugdurchmesser bestellbar (G-Variante siehe Seite 373)

Spezifikation G-Variante:

HPR131GØ[Durchmesser][Toleranz]ME1G-CU134

Abmessungen konfigurierbare Baureihe IT7

d ₁	l ₄	l ₅	HFS-Größe	z
7,000 - 9,590	60	45	12	4
9,600 - 18,590	60	45	12	6

Beispiel Toleranz IT7:

HPR131Ø16.350H7ME1G-CU134

Bohrungsdurchmesser d₁ = 16,350 H7

Beispiel G-Variante:

HPR131GØ16.350-3ME1G-CU134

Spezieller Werkzeugdurchmesser d₁ = 16,350 -3 µm

Maßangaben in mm.

Zugehörige HFS-Wechselkopfhalter ab Seite 460.

Schnittwertempfehlung siehe Kapitelende.

HPR-Wechselkopfreibahle

Feste Ausführung, linkschräg genutet, für Durchgangsbohrung
HPR131

Ausführung:

Reibahldurchmesser: 7,000 - 18,590 mm
 Anschnitt: ME1G
 Schneidstoff: HP421
 Hartmetall
 PVD-beschichtet

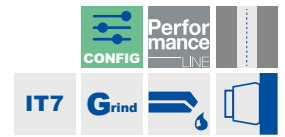
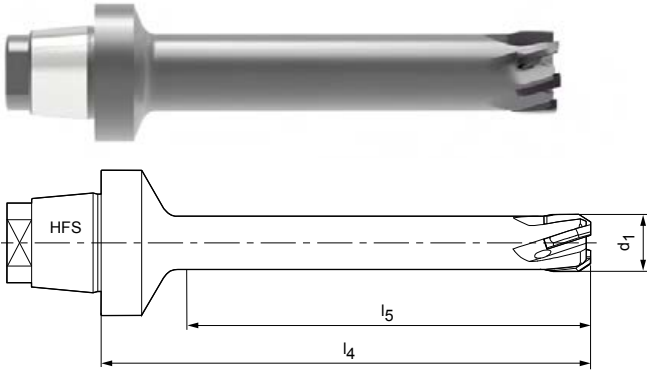

Konfigurierbare Merkmale



Bohrungsdurchmesser Toleranz IT7:

- Durchmesser in Abstufungen von 0,001 mm frei wählbar
- In Toleranz IT7 bestellbar

Spezifikation:

HPR131Ø[Durchmesser][Toleranz]ME1G-HP421

Bohrungsdurchmesser Toleranz < IT7:

- Toleranzen kleiner IT7 als spezieller Werkzeugdurchmesser bestellbar (G-Variante siehe Seite 373)

Spezifikation G-Variante:

HPR131GØ[Durchmesser][Toleranz]ME1G-HP421

Abmessungen konfigurierbare Baureihe IT7

d ₁	l ₄	l ₅	HFS-Größe	z
7,000 - 9,590	60	45	12	4
9,600 - 18,590	60	45	12	6

Beispiel Toleranz IT7:

HPR131Ø16.350H7ME1G-HP421

Bohrungsdurchmesser d₁ = 16,350 H7

Beispiel G-Variante:

HPR131GØ16.350-5ME1G-HP421

Spezieller Werkzeugdurchmesser d₁ = 16,350 -5 µm

Maßangaben in mm.

Zugehörige HFS-Wechselkopfhalter ab Seite 460.

Schnittwertempfehlung siehe Kapitelende.

HPR-Wechselkopfreibahle

Feste Ausführung, linkschräg genutet, für Durchgangsbohrung
HPR131

Ausführung:

Reibahldurchmesser: 7,000 - 18,590 mm
Anschnitt: MF1G
Schneidstoff: HP421
Hartmetall
PVD-beschichtet

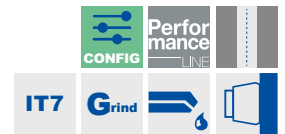
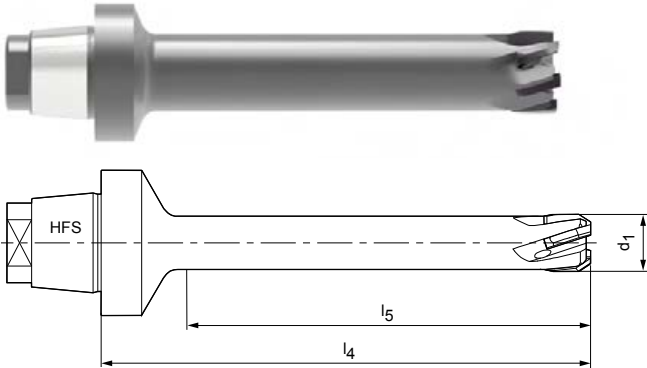

Lagerhaltige Vorzugsbaureihe in H7

d ₁ H7	HFS-Größe	Baumaße			Spezifikation	Bestell-Nr.
		l ₄	l ₅	z		
10,000	12	60	45	6	HPR131Ø10.00H7MF1G-HP421	30710160
11,000	12	60	45	6	HPR131Ø11.00H7MF1G-HP421	30710161
12,000	12	60	45	6	HPR131Ø12.00H7MF1G-HP421	30710162
13,000	12	60	45	6	HPR131Ø13.00H7MF1G-HP421	30710163
14,000	12	60	45	6	HPR131Ø14.00H7MF1G-HP421	30710164
16,000	12	60	45	6	HPR131Ø16.00H7MF1G-HP421	30710166
18,000	12	60	45	6	HPR131Ø18.00H7MF1G-HP421	30710168

Konfigurierbare Merkmale



Bohrungsdurchmesser Toleranz IT7:

- Durchmesser in Abstufungen von 0,001 mm frei wählbar
- In Toleranz IT7 bestellbar

Spezifikation:

HPR131Ø[Durchmesser][Toleranz]MF1G-HP421

Bohrungsdurchmesser Toleranz < IT7:

- Toleranzen kleiner IT7 als spezieller Werkzeugdurchmesser bestellbar (G-Variante siehe Seite 373)

Spezifikation G-Variante:

HPR131GØ[Durchmesser][Toleranz]MF1G-HP421

Abmessungen konfigurierbare Baureihe IT7

d ₁	l ₄	l ₅	HFS-Größe	z
7,000 - 9,590	60	45	12	4
9,600 - 18,590	60	45	12	6

Beispiel Toleranz IT7:

HPR131Ø16.350H7MF1G-HP421

Bohrungsdurchmesser d₁ = 16,350 H7

Beispiel G-Variante:

HPR131GØ16.350-5MF1G-HP421

Spezieller Werkzeugdurchmesser d₁ = 16,350 -5 µm

Maßangaben in mm.

Zugehörige HFS-Wechselkopfhalter ab Seite 460.

Schnittwertempfehlung siehe Kapitelende.

HPR-Wechselkopffreibahle

Feste Ausführung, linkschräg genutet, für Durchgangsbohrung
HPR131

Ausführung:

Reibahldurchmesser: 7,000 - 18,590 mm
 Anschnitt: MF1G
 Schneidstoff: HP612
 Hartmetall
 PVD-beschichtet

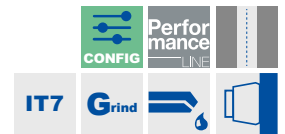
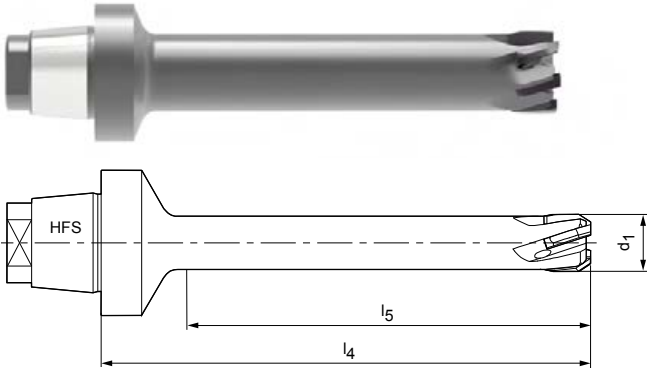

Konfigurierbare Merkmale



Bohrungsdurchmesser Toleranz IT7:

- Durchmesser in Abstufungen von 0,001 mm frei wählbar
- In Toleranz IT7 bestellbar

Spezifikation:

HPR131Ø[Durchmesser][Toleranz]MF1G-HP612

Bohrungsdurchmesser Toleranz < IT7:

- Toleranzen kleiner IT7 als spezieller Werkzeugdurchmesser bestellbar (G-Variante siehe Seite 373)

Spezifikation G-Variante:

HPR131GØ[Durchmesser][Toleranz]MF1G-HP612

Abmessungen konfigurierbare Baureihe IT7

d ₁	l ₄	l ₅	HFS-Größe	z
7,000 - 9,590	60	45	12	4
9,600 - 18,590	60	45	12	6

Beispiel Toleranz IT7:

HPR131Ø16.350H7MF1G-HP612

Bohrungsdurchmesser d₁ = 16,350 H7

Beispiel G-Variante:

HPR131GØ16.350-7MF1G-HP612

Spezieller Werkzeugdurchmesser d₁ = 16,350 -7 µm

Maßangaben in mm.

Zugehörige HFS-Wechselkopfhalter ab Seite 460.

Schnittwertempfehlung siehe Kapitelende.

HPR-Wechselkopfreibahle

Feste Ausführung, gerade genutet, für Durchgangsbohrung
HPR100

Ausführung:

Reibahldurchmesser: 15,600 - 65,000 mm
 Anschnitt: MC1G
 Schneidstoff: CP134
 Cermet
 PVD-beschichtet

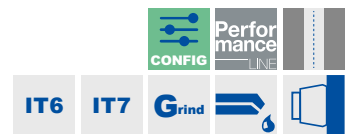
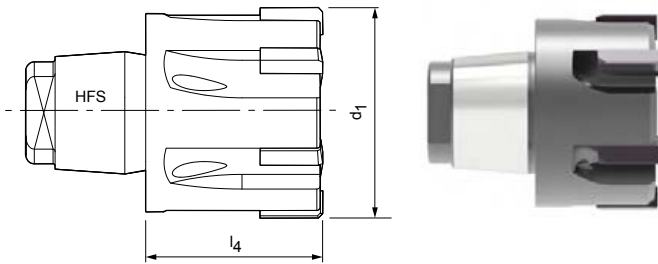

Konfigurierbare Merkmale



Bohrungsdurchmesser Toleranz IT6/IT7:

- Durchmesser in Abstufungen von 0,001 mm frei wählbar
- Abhängig vom Durchmesserbereich ab Toleranz IT6/IT7 bestellbar
- > Ø30,000 IT6 | ≤ Ø30,000 IT7

Spezifikation:

HPR100Ø[Durchmesser][Toleranz]MC1G-CP134

Bohrungsdurchmesser Toleranz < IT6/IT7:

- Toleranzen kleiner IT6/IT7 als spezieller Werkzeugdurchmesser bestellbar (G-Variante siehe Seite 373)

Spezifikation G-Variante:

HPR100GØ[Durchmesser][Toleranz]MC1G-CP134

Abmessungen konfigurierbare Baureihe IT6/IT7

d1	l4	l5	HFS-Größe	z	Toleranz
15,600 - 18,590	14	-	10	6	IT7
18,600 - 21,290	14,5	-	12	6	IT7
21,300 - 23,990	15,5	-	14	6	IT7
24,000 - 29,990	16	-	16	6	IT7
30,000 - 39,990	17	-	20	8	IT6
40,000 - 50,700	19	-	24	8	IT6
50,710 - 65,000	25	-	24	8	IT6

Beispiel Toleranz IT7:

HPR100Ø16.350H7MC1G-CP134

Bohrungsdurchmesser d₁ = 16,350 H7

Beispiel G-Variante:

HPR100GØ16.350-5MC1G-CP134

Spezieller Werkzeugdurchmesser d₁ = 16,350 -5 µm

Maßangaben in mm.

* für Oberflächen R_a < 2 µm

Zugehörige HFS-Wechselkopfhalter ab Seite 460.

Schnittwertempfehlung siehe Kapitelende.

HPR-Wechselkopfreibahle

Feste Ausführung, gerade genutet, für Durchgangsbohrung
HPR100

Ausführung:

Reibahldurchmesser: 15,600 - 65,000 mm
 Anschnitt: MC1G
 Schneidstoff: Hartmetall
 CVD-beschichtet

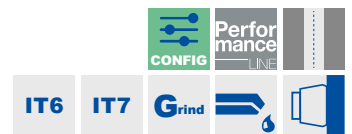
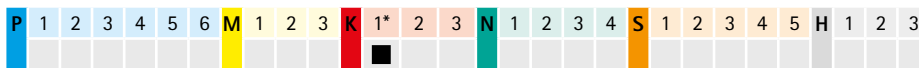
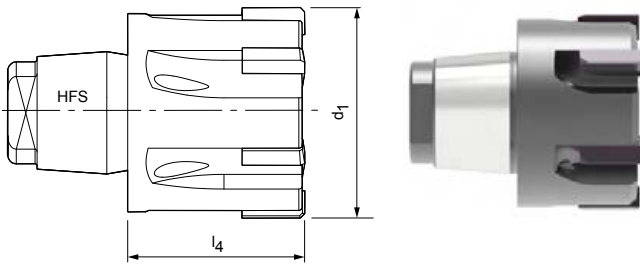

Konfigurierbare Merkmale



Bohrungsdurchmesser Toleranz IT6/IT7:

- Durchmesser in Abstufungen von 0,001 mm frei wählbar
- Abhängig vom Durchmesserbereich ab Toleranz IT6/IT7 bestellbar
- > Ø30,000 IT6 | ≤ Ø30,000 IT7

Spezifikation:

HPR100Ø[Durchmesser][Toleranz]MC1G-HC419

Bohrungsdurchmesser Toleranz < IT6/IT7:

- Toleranzen kleiner IT6/IT7 als spezieller Werkzeugdurchmesser bestellbar (G-Variante siehe Seite 373)

Spezifikation G-Variante:

HPR100GØ[Durchmesser][Toleranz]MC1G-HC419

Abmessungen konfigurierbare Baureihe IT6/IT7

d1	l4	l5	HFS-Größe	z	Toleranz
15,600 - 18,590	14	-	10	6	IT7
18,600 - 21,290	14,5	-	12	6	IT7
21,300 - 23,990	15,5	-	14	6	IT7
24,000 - 29,990	16	-	16	6	IT7
30,000 - 39,990	17	-	20	8	IT6
40,000 - 50,700	19	-	24	8	IT6
50,710 - 65,000	25	-	24	8	IT6

Beispiel Toleranz IT7:

HPR100Ø16.350H7MC1G-HC419

Bohrungsdurchmesser d₁ = 16,350 H7

Beispiel G-Variante:

HPR100GØ16.350-7MC1G-HC419

Spezieller Werkzeugdurchmesser d₁ = 16,350 -7 µm

Maßangaben in mm.

* für Oberflächen Ra > 2 µm

Zugehörige HFS-Wechselkopfhalter ab Seite 460.

Schnittwertempfehlung siehe Kapitelende.



HPR-Wechselkopfreibahle

Feste Ausführung, gerade genutet, für Durchgangsbohrung
HPR100

Ausführung:

Reibahldurchmesser: 15,600 – 65,000 mm
 Anschnitt: MC1G
 Schneidstoff: HP421
 Hartmetall
 PVD-beschichtet

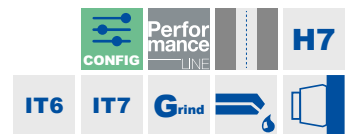
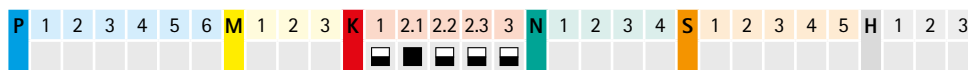
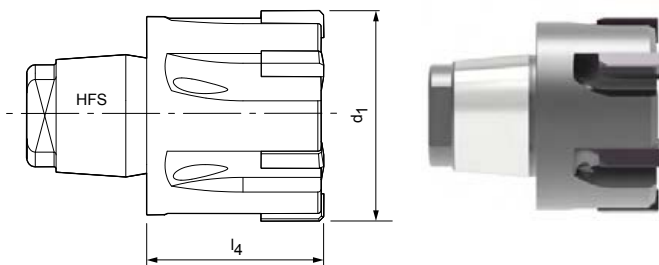
Lagerhaltige Vorzugsbaureihe in H7

d ₁ H7	HFS-Größe	Baumaße		Spezifikation	Bestell-Nr.
		l ₄	z		
19,000	12	14,5	6	HPR100Ø19H7MC1G-HP421	30037777
20,000	12	14,5	6	HPR100Ø20H7MC1G-HP421	30191340
22,000	14	15,5	6	HPR100Ø22H7MC1G-HP421	30368857
24,000	16	16	6	HPR100Ø24H7MC1G-HP421	30181729
25,000	16	16	6	HPR100Ø25H7MC1G-HP421	30537929
26,000	16	16	6	HPR100Ø26H7MC1G-HP421	30076945
28,000	16	16	6	HPR100Ø28H7MC1G-HP421	30025212
30,000	20	17	8	HPR100Ø30H7MC1G-HP421	30031345
32,000	20	17	8	HPR100Ø32H7MC1G-HP421	30438453
35,000	20	17	8	HPR100Ø35H7MC1G-HP421	30537930
40,000	24	19	8	HPR100Ø40H7MC1G-HP421	30083953
45,000	24	19	8	HPR100Ø45H7MC1G-HP421	30537931
50,000	24	19	8	HPR100Ø50H7MC1G-HP421	30710245
55,000	24	25	8	HPR100Ø55H7MC1G-HP421	30419154
60,000	24	25	8	HPR100Ø60H7MC1G-HP421	30350208
65,000	24	25	8	HPR100Ø65H7MC1G-HP421	30272888

Maßangaben in mm.

Zugehörige HFS-Wechselkopfhalter ab Seite 460.

Schnittwertempfehlung siehe Kapitelende.

HPR100 | Feste Ausführung, gerade genutet

Konfigurierbare Merkmale

**Bohrungsdurchmesser Toleranz IT6/IT7:**

- Durchmesser in Abstufungen von 0,001 mm frei wählbar
- Abhängig vom Durchmesserbereich ab Toleranz IT6/IT7 bestellbar
- > Ø30,000 IT6 | ≤ Ø30,000 IT7

**Spezifikation:**

HPR100Ø[Durchmesser][Toleranz]MC1G-HP421

Bohrungsdurchmesser Toleranz < IT6/IT7:

- Toleranzen kleiner IT6/IT7 als spezieller Werkzeugdurchmesser bestellbar (G-Variante siehe Seite 373)

Spezifikation G-Variante:

HPR100GØ[Durchmesser][Toleranz]MC1G-HP421

Abmessungen konfigurierbare Baureihe IT6/IT7

d1	l ₄	l ₅	HFS-Größe	z	Toleranz
15,600 - 18,590	14	-	10	6	IT7
18,600 - 21,290	14,5	-	12	6	IT7
21,300 - 23,990	15,5	-	14	6	IT7
24,000 - 29,990	16	-	16	6	IT7
30,000 - 39,990	17	-	20	8	IT6
40,000 - 50,700	19	-	24	8	IT6
50,710 - 65,000	25	-	24	8	IT6

Beispiel Toleranz IT7:

HPR100Ø16.350H7MC1G-HP421

Bohrungsdurchmesser d₁ = 16,350 H7**Beispiel G-Variante:**

HPR100GØ16.350-5MC1G-HP421

Spezieller Werkzeugdurchmesser d₁ = 16,350 -5 µm

HPR-Wechselkopfreibahle

Feste Ausführung, gerade genutet, für Durchgangsbohrung
HPR100

Ausführung:

Reibahldurchmesser: 15,600 - 65,000 mm
 Anschnitt: MC1G
 Schneidstoff: HP423
 Hartmetall
 PVD-beschichtet

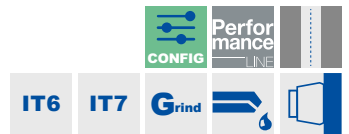
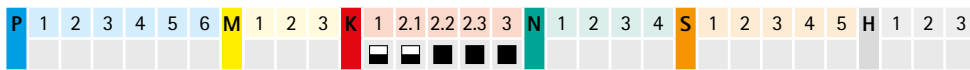
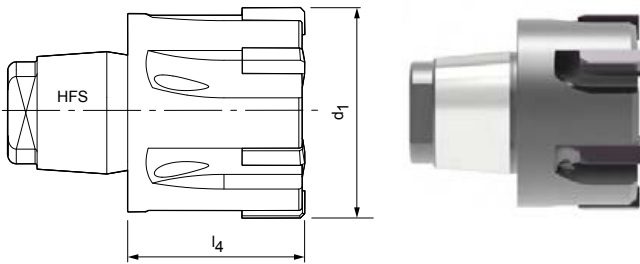

Konfigurierbare Merkmale

Bohrungsdurchmesser Toleranz IT6/IT7:

- Durchmesser in Abstufungen von 0,001 mm frei wählbar
- Abhängig vom Durchmesserbereich ab Toleranz IT6/IT7 bestellbar
- > Ø30,000 IT6 | ≤ Ø30,000 IT7

Spezifikation:
HPR100Ø[Durchmesser][Toleranz]MC1G-HP423

Bohrungsdurchmesser Toleranz < IT6/IT7:

- Toleranzen kleiner IT6/IT7 als spezieller Werkzeugdurchmesser bestellbar (G-Variante siehe Seite 373)

Spezifikation G-Variante:
HPR100GØ[Durchmesser][Toleranz]MC1G-HP423

Abmessungen konfigurierbare Baureihe IT6/IT7

d1	l4	l5	HFS-Größe	z	Toleranz
15,600 - 18,590	14	-	10	6	IT7
18,600 - 21,290	14,5	-	12	6	IT7
21,300 - 23,990	15,5	-	14	6	IT7
24,000 - 29,990	16	-	16	6	IT7
30,000 - 39,990	17	-	20	8	IT6
40,000 - 50,700	19	-	24	8	IT6
50,710 - 65,000	25	-	24	8	IT6

Beispiel Toleranz IT7:

HPR100Ø16.350H7MC1G-HP423

Bohrungsdurchmesser d₁ = 16,350 H7

Beispiel G-Variante:

HPR100GØ16.350-8MC1G-HP423

Spezieller Werkzeugdurchmesser d₁ = 16,350 -7 µm

Maßangaben in mm.
 Zugehörige HFS-Wechselkopfhalter ab Seite 460.
 Schnittwertempfehlung siehe Kapitelende.

HPR-Wechselkopffreibahle

Feste Ausführung, gerade genutet, für Durchgangsbohrung
HPR100

Ausführung:

Reibahldurchmesser: 15,600 - 65,000 mm
Anschnitt: MA0A
Schneidstoff: PU620
PKD-bestückt

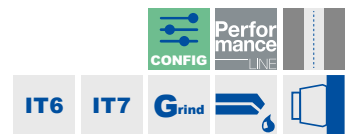
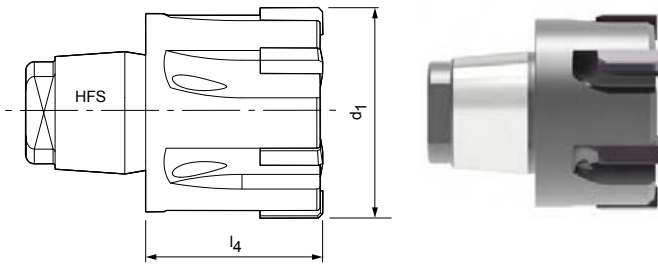

Konfigurierbare Merkmale



Bohrungsdurchmesser Toleranz IT6/IT7:

- Durchmesser in Abstufungen von 0,001 mm frei wählbar
- Abhängig vom Durchmesserbereich ab Toleranz IT6/IT7 bestellbar
- > Ø30,000 IT6 | ≤ Ø30,000 IT7

Spezifikation:

HPR100Ø[Durchmesser][Toleranz]MA0A-PU620

Bohrungsdurchmesser Toleranz < IT6/IT7:

- Toleranzen kleiner IT6/IT7 als spezieller Werkzeugdurchmesser bestellbar (G-Variante siehe Seite 373)

Spezifikation G-Variante:

HPR100GØ[Durchmesser][Toleranz]MA0A-PU620

Abmessungen konfigurierbare Baureihe IT6/IT7

d1	l ₄	l ₅	HFS-Größe	z	Toleranz
15,600 - 18,590	14	-	10	6	IT7
18,600 - 21,290	14,5	-	12	6	IT7
21,300 - 23,990	15,5	-	14	6	IT7
24,000 - 29,990	16	-	16	6	IT7
30,000 - 39,990	17	-	20	8	IT6
40,000 - 50,700	19	-	24	8	IT6
50,710 - 65,000	25	-	24	8	IT6

Beispiel Toleranz IT7:

HPR100Ø16.350H7MA0A-PU620

Bohrungsdurchmesser d₁ = 16,350 H7

Beispiel G-Variante:

HPR100GØ16.350-3MA0A-PU620

Spezieller Werkzeugdurchmesser d₁ = 16,350 -3 µm

Maßangaben in mm.

Zugehörige HFS-Wechselkopfhalter ab Seite 460.

Schnittwertempfehlung siehe Kapitelende.

HPR-Wechselkopfreibahle

Feste Ausführung, linksschräg genutet, für Durchgangsbohrung
HPR110

Ausführung:

Reibahldurchmesser: 15,600 - 65,000 mm
 Anschnitt: ME1G
 Schneidstoff: CU134
 Cermet unbeschichtet

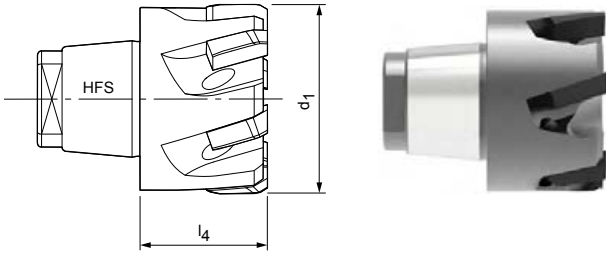

Lagerhaltige Vorzugsbaureihe in H7

d ₁ H7	HFS-Größe	Baumaße		Spezifikation	Bestell-Nr.
		l ₄	z		
19,000	12	14,5	6	HPR110Ø19H7ME1G-CU134	30077358
20,000	12	14,5	6	HPR110Ø20H7ME1G-CU134	30040404
21,000	12	14,5	6	HPR110Ø21H7ME1G-CU134	30039919
22,000	14	15,5	6	HPR110Ø22H7ME1G-CU134	30081546
23,000	14	15,5	6	HPR110Ø23H7ME1G-CU134	30085368
24,000	16	16	6	HPR110Ø24H7ME1G-CU134	30080958
25,000	16	16	6	HPR110Ø25H7ME1G-CU134	30076110
26,000	16	16	6	HPR110Ø26H7ME1G-CU134	30045730
27,000	16	16	6	HPR110Ø27H7ME1G-CU134	30087257
28,000	16	16	6	HPR110Ø28H7ME1G-CU134	30046121
30,000	20	17	8	HPR110Ø30H7ME1G-CU134	30045095
31,000	20	17	8	HPR110Ø31H7ME1G-CU134	30192960
32,000	20	17	8	HPR110Ø32H7ME1G-CU134	30084530
33,000	20	17	8	HPR110Ø33H7ME1G-CU134	30162282
34,000	20	17	8	HPR110Ø34H7ME1G-CU134	30043743
35,000	20	17	8	HPR110Ø35H7ME1G-CU134	30084885
39,000	20	17	8	HPR110Ø39H7ME1G-CU134	30088042
40,000	24	19	8	HPR110Ø40H7ME1G-CU134	30045097
42,000	24	19	8	HPR110Ø42H7ME1G-CU134	30080437
44,000	24	19	8	HPR110Ø44H7ME1G-CU134	30097178
45,000	24	19	8	HPR110Ø45H7ME1G-CU134	30049313
50,000	24	19	8	HPR110Ø50H7ME1G-CU134	30219386
55,000	24	25	8	HPR110Ø55H7ME1G-CU134	30196567
60,000	24	25	8	HPR110Ø60H7ME1G-CU134	30242416
65,000	24	25	8	HPR110Ø65H7ME1G-CU134	30236537

Maßangaben in mm.

Zugehörige HFS-Wechselkopfhalter ab Seite 460.

Schnittwertempfehlung siehe Kapitelende.

HPR110 | Feste Ausführung, linksschräg genutet

Konfigurierbare Merkmale

**Bohrungsdurchmesser Toleranz IT6/IT7:**

- Durchmesser in Abstufungen von 0,001 mm frei wählbar
- Abhängig vom Durchmesserbereich ab Toleranz IT6/IT7 bestellbar
- > Ø30,000 IT6 | ≤ Ø30,000 IT7

**Spezifikation:**

HPR110Ø[Durchmesser][Toleranz]ME1G-CU134

Bohrungsdurchmesser Toleranz < IT6/IT7:

- Toleranzen kleiner IT6/IT7 als spezieller Werkzeugdurchmesser bestellbar (G-Variante siehe Seite 373)

Spezifikation G-Variante:

HPR110GØ[Durchmesser][Toleranz]ME1G-CU134

Abmessungen konfigurierbare Baureihe IT6/IT7

d1	l ₄	l ₅	HFS-Größe	z	Toleranz
15,600 - 18,590	14	-	10	6	IT7
18,600 - 21,290	14,5	-	12	6	IT7
21,300 - 23,990	15,5	-	14	6	IT7
24,000 - 29,990	16	-	16	6	IT7
30,000 - 39,990	17	-	20	8	IT6
40,000 - 50,700	19	-	24	8	IT6
50,710 - 65,000	25	-	24	8	IT6

Beispiel Toleranz IT7:

HPR110Ø16.350H7ME1G-CU134

Bohrungsdurchmesser d₁ = 16,350 H7**Beispiel G-Variante:**

HPR110GØ16.350-3ME1G-CU134

Spezieller Werkzeugdurchmesser d₁ = 16,350 -3 µm

HPR-Wechselkopfreibahle

Feste Ausführung, linksschräg genutet, für Durchgangsbohrung
HPR110

Ausführung:

Reibahldurchmesser: 15,600 - 65,000 mm
 Anschnitt: ME1G
 Schneidstoff: HP421
 Hartmetall
 PVD-beschichtet

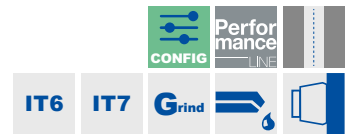
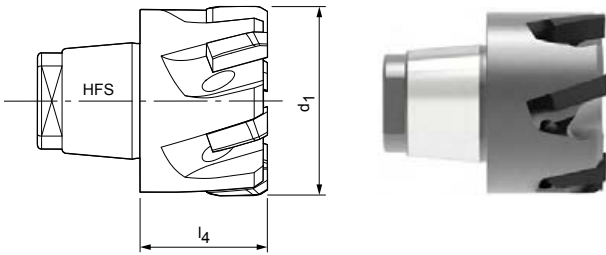

Konfigurierbare Merkmale



Bohrungsdurchmesser Toleranz IT6/IT7:

- Durchmesser in Abstufungen von 0,001 mm frei wählbar
- Abhängig vom Durchmesserbereich ab Toleranz IT6/IT7 bestellbar
- > Ø30,000 IT6 | ≤ Ø30,000 IT7

Spezifikation:

HPR110Ø[Durchmesser][Toleranz]ME1G-HP421

Bohrungsdurchmesser Toleranz < IT6/IT7:

- Toleranzen kleiner IT6/IT7 als spezieller Werkzeugdurchmesser bestellbar (G-Variante siehe Seite 373)

Spezifikation G-Variante:

HPR110GØ[Durchmesser][Toleranz]ME1G-HP421

Abmessungen konfigurierbare Baureihe IT6/IT7

d1	l4	l5	HFS-Größe	z	Toleranz
15,600 - 18,590	14	-	10	6	IT7
18,600 - 21,290	14,5	-	12	6	IT7
21,300 - 23,990	15,5	-	14	6	IT7
24,000 - 29,990	16	-	16	6	IT7
30,000 - 39,990	17	-	20	8	IT6
40,000 - 50,700	19	-	24	8	IT6
50,710 - 65,000	25	-	24	8	IT6

Beispiel Toleranz IT7:

HPR110Ø16.350H7ME1G-HP421

Bohrungsdurchmesser d₁ = 16,350 H7

Beispiel G-Variante:

HPR110GØ16.350-5ME1G-HP421

Spezieller Werkzeugdurchmesser d₁ = 16,350 -5 µm

Maßangaben in mm.

Zugehörige HFS-Wechselkopfhalter ab Seite 460.

Schnittwertempfehlung siehe Kapitelende.

HPR-Wechselkopfreibahle

Feste Ausführung, linksschräg genutet, für Durchgangsbohrung
HPR110

Ausführung:

Reibahldurchmesser: 15,600 - 65,000 mm
Anschnitt: MF1G
Schneidstoff: HP612
Hartmetall
PVD-beschichtet

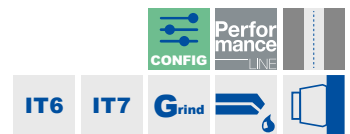
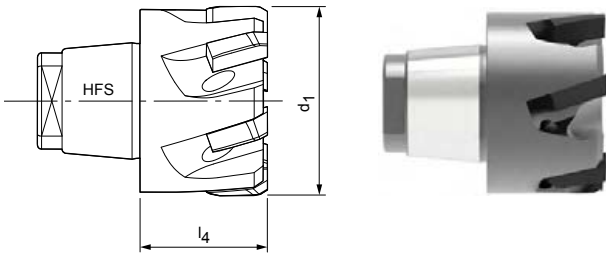

Konfigurierbare Merkmale

Bohrungsdurchmesser Toleranz IT6/IT7:

- Durchmesser in Abstufungen von 0,001 mm frei wählbar
- Abhängig vom Durchmesserbereich ab Toleranz IT6/IT7 bestellbar
- > Ø30,000 IT6 | ≤ Ø30,000 IT7

Spezifikation:

HPR110Ø[Durchmesser][Toleranz]MF1G-HP612

Bohrungsdurchmesser Toleranz < IT6/IT7:

- Toleranzen kleiner IT6/IT7 als spezieller Werkzeugdurchmesser bestellbar (G-Variante siehe Seite 373)

Spezifikation G-Variante:

HPR110GØ[Durchmesser][Toleranz]MF1G-HP612

Abmessungen konfigurierbare Baureihe IT6/IT7

d1	l4	l5	HFS-Größe	z	Toleranz
15,600 - 18,590	14	-	10	6	IT7
18,600 - 21,290	14,5	-	12	6	IT7
21,300 - 23,990	15,5	-	14	6	IT7
24,000 - 29,990	16	-	16	6	IT7
30,000 - 39,990	17	-	20	8	IT6
40,000 - 50,700	19	-	24	8	IT6
50,710 - 65,000	25	-	24	8	IT6

Beispiel Toleranz IT7:

HPR110Ø16.350H7MF1G-HP612

Bohrungsdurchmesser d₁ = 16,350 H7

Beispiel G-Variante:

HPR110GØ16.350-7MF1G-HP612

Spezieller Werkzeugdurchmesser d₁ = 16,350 -7 µm

Maßangaben in mm.

Zugehörige HFS-Wechselkopfhalter ab Seite 460.

Schnittwertempfehlung siehe Kapitelende.

HPR-Wechselkopfreibahle

Feste Ausführung, linksschräg genutet, für Durchgangsbohrung
HPR110

Ausführung:

Reibahldurchmesser: 15,600 – 65,000 mm
 Anschnitt: MF1G
 Schneidstoff: HP421
 Hartmetall
 PVD-beschichtet

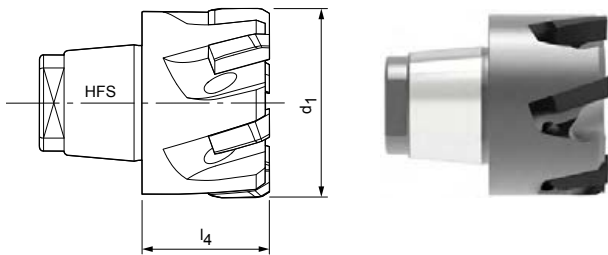
Lagerhaltige Vorzugsbaureihe in H7

d ₁ H7	HFS-Größe	Baumaße		Spezifikation	Bestell-Nr.
		l ₄	z		
19,000	12	14,5	6	HPR110Ø19H7MF1G-HP421	30710291
20,000	12	14,5	6	HPR110Ø20H7MF1G-HP421	30401369
22,000	14	15,5	6	HPR110Ø22H7MF1G-HP421	30710293
23,000	14	15,5	6	HPR110Ø23H7MF1G-HP421	30710294
24,000	16	16	6	HPR110Ø24H7MF1G-HP421	30710295
25,000	16	16	6	HPR110Ø25H7MF1G-HP421	30318503
26,000	16	16	6	HPR110Ø26H7MF1G-HP421	30710296
27,000	16	16	6	HPR110Ø27H7MF1G-HP421	30710297
28,000	16	16	6	HPR110Ø28H7MF1G-HP421	30710298
30,000	20	17	8	HPR110Ø30H7MF1G-HP421	30576508
31,000	20	17	8	HPR110Ø31H7MF1G-HP421	30710300
32,000	20	17	8	HPR110Ø32H7MF1G-HP421	30671985
33,000	20	17	8	HPR110Ø33H7MF1G-HP421	30710301
34,000	20	17	8	HPR110Ø34H7MF1G-HP421	30710302
35,000	20	17	8	HPR110Ø35H7MF1G-HP421	30710303
39,000	20	17	8	HPR110Ø39H7MF1G-HP421	30710307
40,000	24	19	8	HPR110Ø40H7MF1G-HP421	30498368

Maßangaben in mm.

Zugehörige HFS-Wechselkopfhalter ab Seite 460.

Schnittwertempfehlung siehe Kapitelende.

HPR110 | Feste Ausführung, linksschräg genutet

Konfigurierbare Merkmale

**Bohrungsdurchmesser Toleranz IT6/IT7:**

- Durchmesser in Abstufungen von 0,001 mm frei wählbar
- Abhängig vom Durchmesserbereich ab Toleranz IT6/IT7 bestellbar
- > Ø30,000 IT6 | ≤ Ø30,000 IT7

**Spezifikation:**

HPR110Ø[Durchmesser][Toleranz]MF1G-HP421

Bohrungsdurchmesser Toleranz < IT6/IT7:

- Toleranzen kleiner IT6/IT7 als spezieller Werkzeugdurchmesser bestellbar (G-Variante siehe Seite 373)

Spezifikation G-Variante:

HPR110GØ[Durchmesser][Toleranz]MF1G-HP421

Abmessungen konfigurierbare Baureihe IT6/IT7

d1	l ₄	l ₅	HFS-Größe	z	Toleranz
15,600 - 18,590	14	-	10	6	IT7
18,600 - 21,290	14,5	-	12	6	IT7
21,300 - 23,990	15,5	-	14	6	IT7
24,000 - 29,990	16	-	16	6	IT7
30,000 - 39,990	17	-	20	8	IT6
40,000 - 50,700	19	-	24	8	IT6
50,710 - 65,000	25	-	24	8	IT6

Beispiel Toleranz IT7:

HPR110Ø16.350H7MF1G-HP421

Bohrungsdurchmesser d₁ = 16,350 H7**Beispiel G-Variante:**

HPR110GØ16.350-5MF1G-HP421

Spezieller Werkzeugdurchmesser d₁ = 16,350 -5 µm

HPR-Wechselkopffreibahle

Feste Ausführung, gerade genutet, für Grundbohrung
HPR180

Ausführung:

Reibahlerdurchmesser: 7,000 - 21,290 mm
 Anschnitt: ML2G
 Schneidstoff: CU134
 Cermet unbeschichtet

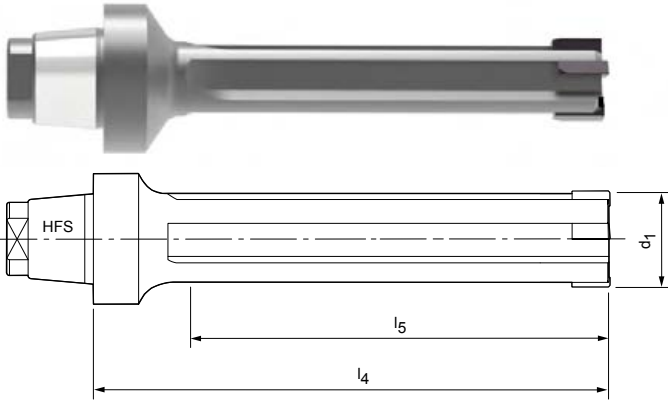

Konfigurierbare Merkmale

Bohrungsdurchmesser Toleranz IT7:

- Durchmesser in Abstufungen von 0,001 mm frei wählbar
- Ab Toleranz IT7 bestellbar

Spezifikation:
HPR180Ø[Durchmesser][Toleranz]ML2G-CU134

Bohrungsdurchmesser Toleranz < IT7:

- Toleranzen kleiner IT7 als spezieller Werkzeugdurchmesser bestellbar (G-Variante siehe Seite 373)

Spezifikation G-Variante:
HPR180GØ[Durchmesser][Toleranz]ML2G-CU134

Abmessungen konfigurierbare Baureihe IT7

d1	l4	l5	HFS-Größe	z
7,000 - 14,590	60	40	12	4
14,600 - 21,290	60	40	12	6

Beispiel Toleranz IT7:
HPR180Ø16.350H7ML2G-CU134

Bohrungsdurchmesser d₁ = 16,350 H7

Beispiel G-Variante:
HPR180GØ16.350-3ML2G-CU134

Spezieller Werkzeugdurchmesser d₁ = 16,350 -3 µm

Maßangaben in mm.
 Zugehörige HFS-Wechselkopfhalter ab Seite 460.
 Schnittwertempfehlung siehe Kapitelende.

HPR-Wechselkopffreibahle

Feste Ausführung, gerade genutet, für Grundbohrung
HPR180

Ausführung:

Reibahldurchmesser: 7,000 - 21,290 mm
Anschnitt: ML2G
Schneidstoff: HP421
Hartmetall
PVD-beschichtet

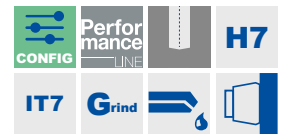
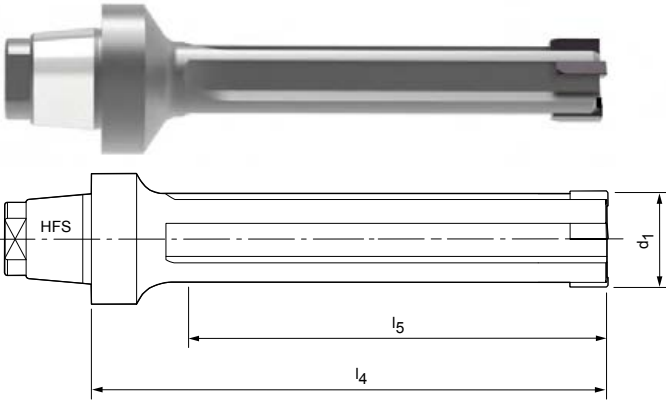

Lagerhaltige Vorzugsbaureihe in H7

d ₁ H7	HFS-Größe	Baumaße			Spezifikation	Bestell-Nr.
		l ₄	l ₅	z		
10,000	12	60	40	4	HPR180Ø10H7ML2G-HP421	30710208
12,000	12	60	40	4	HPR180Ø12H7ML2G-HP421	30710210
14,000	12	60	40	4	HPR180Ø14H7ML2G-HP421	30710212
16,000	12	60	40	6	HPR180Ø16H7ML2G-HP421	30710214
18,000	12	60	40	6	HPR180Ø18H7ML2G-HP421	30710216
19,000	12	60	40	6	HPR180Ø19H7ML2G-HP421	30710217
20,000	12	60	40	6	HPR180Ø20H7ML2G-HP421	30710218

Konfigurierbare Merkmale



Bohrungsdurchmesser Toleranz IT7:

- Durchmesser in Abstufungen von 0,001 mm frei wählbar
- Ab Toleranz IT7 bestellbar

Spezifikation:

HPR180Ø[Durchmesser][Toleranz]ML2G-HP421

Bohrungsdurchmesser Toleranz < IT7:

- Toleranzen kleiner IT7 als spezieller Werkzeugdurchmesser bestellbar (G-Variante siehe Seite 373)

Spezifikation G-Variante:

HPR180GØ[Durchmesser][Toleranz]ML2G-HP421

Abmessungen konfigurierbare Baureihe IT7

d ₁	l ₄	l ₅	HFS-Größe	z
7,000 - 14,590	60	40	12	4
14,600 - 21,290	60	40	12	6

Beispiel Toleranz IT7:

HPR180Ø16.350H7ML2G-HP421

Bohrungsdurchmesser d₁ = 16,350 H7

Beispiel G-Variante:

HPR180GØ16.350-5ML2G-HP421

Spezieller Werkzeugdurchmesser d₁ = 16,350 -5 µm

Maßangaben in mm.

Zugehörige HFS-Wechselkopfhalter ab Seite 460.

Schnittwertempfehlung siehe Kapitelende.

HPR-Wechselkopffreibahle

Feste Ausführung, gerade genutet, für Grundbohrung
HPR180

Ausführung:

Reibahldurchmesser: 7,000 - 21,290 mm
 Anschnitt: M02G
 Schneidstoff: HP421
 Hartmetall
 PVD-beschichtet

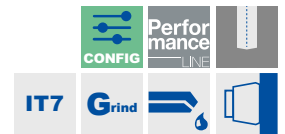
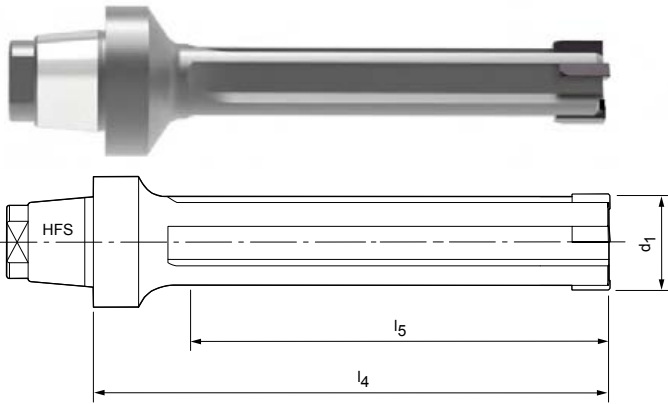

Konfigurierbare Merkmale



Bohrungsdurchmesser Toleranz IT7:

- Durchmesser in Abstufungen von 0,001 mm frei wählbar
- Ab Toleranz IT7 bestellbar

Spezifikation:

HPR180Ø[Durchmesser][Toleranz]M02G-HP421

Bohrungsdurchmesser Toleranz < IT7:

- Toleranzen kleiner IT7 als spezieller Werkzeugdurchmesser bestellbar (G-Variante siehe Seite 373)

Spezifikation G-Variante:

HPR180GØ[Durchmesser][Toleranz]M02G-HP421

Abmessungen konfigurierbare Baureihe IT7

d1	l4	l5	HFS-Größe	z
7,000 - 14,590	60	40	12	4
14,600 - 21,290	60	40	12	6

Beispiel Toleranz IT7:

HPR180Ø16.350H7M02G-HP421

Bohrungsdurchmesser d₁ = 16,350 H7

Beispiel G-Variante:

HPR180GØ16.350-5M02G-HP421

Spezieller Werkzeugdurchmesser d₁ = 16,350 -5 µm

Maßangaben in mm.

Zugehörige HFS-Wechselkopfhalter ab Seite 460.

Schnittwertempfehlung siehe Kapitelende.

HPR-Wechselkopffreibahle

Feste Ausführung, gerade genutet, für Grundbohrung
HPR180

Ausführung:

Reibahldurchmesser: 7,000 - 21,290 mm
Anschnitt: MC1G
Schneidstoff: CP134
Cermet
PVD-beschichtet

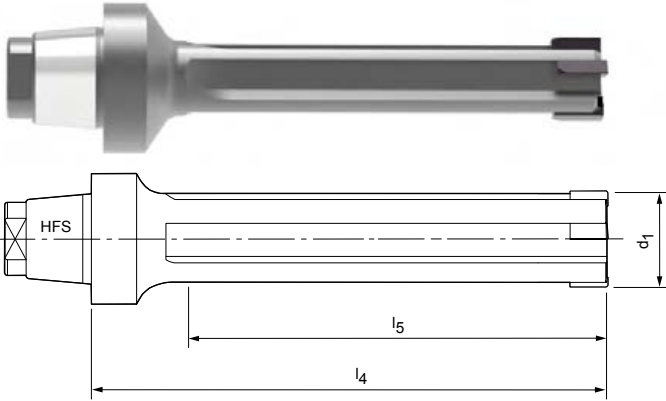

Konfigurierbare Merkmale



Bohrungsdurchmesser Toleranz IT7:

- Durchmesser in Abstufungen von 0,001 mm frei wählbar
- Ab Toleranz IT7 bestellbar

Spezifikation:

HPR180Ø[Durchmesser][Toleranz]MC1G-CP134

Bohrungsdurchmesser Toleranz < IT7:

- Toleranzen kleiner IT7 als spezieller Werkzeugdurchmesser bestellbar (G-Variante siehe Seite 373)

Spezifikation G-Variante:

HPR180GØ[Durchmesser][Toleranz]MC1G-CP134

Abmessungen konfigurierbare Baureihe IT7

d1	l4	l5	HFS-Größe	z
7,000 - 14,590	60	40	12	4
14,600 - 21,290	60	40	12	6

Beispiel Toleranz IT7:

HPR180Ø16.350H7MC1G-CP134

Bohrungsdurchmesser $d_1 = 16,350 \text{ H7}$

Beispiel G-Variante:

HPR180GØ16.350-5MC1G-CP134

Spezieller Werkzeugdurchmesser $d_1 = 16,350 -5 \mu\text{m}$

Maßangaben in mm.

* für Oberflächen $R_a > 2 \mu\text{m}$

Zugehörige HFS-Wechselkopfhalter ab Seite 460.

Schnittwertempfehlung siehe Kapitelende.

HPR-Wechselkopfreibahle

Feste Ausführung, gerade genutet, für Grundbohrung
HPR180

Ausführung:

Reibahldurchmesser: 7,000 - 21,290 mm
Anschnitt: MC1G
Schneidstoff: Hartmetall
CVD-beschichtet

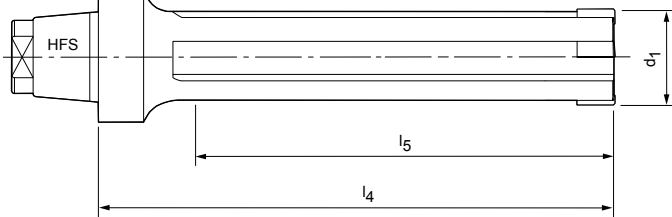

Konfigurierbare Merkmale



Bohrungsdurchmesser Toleranz IT7:

- Durchmesser in Abstufungen von 0,001 mm frei wählbar
- Ab Toleranz IT7 bestellbar

Spezifikation:

HPR180Ø[Durchmesser][Toleranz]MC1G-HC419

Bohrungsdurchmesser Toleranz < IT7:

- Toleranzen kleiner IT7 als spezieller Werkzeugdurchmesser bestellbar (G-Variante siehe Seite 373)

Spezifikation G-Variante:

HPR180GØ[Durchmesser][Toleranz]MC1G-HC419

Abmessungen konfigurierbare Baureihe IT7

d1	l4	l5	HFS-Größe	z
7,000 - 14,590	60	40	12	4
14,600 - 21,290	60	40	12	6

Beispiel Toleranz IT7:

HPR180Ø16.350H7MC1G-HC419

Bohrungsdurchmesser $d_1 = 16,350 \text{ H7}$

Beispiel G-Variante:

HPR180GØ16.350-7MC1G-HC419

Spezieller Werkzeugdurchmesser $d_1 = 16,350 -7 \mu\text{m}$

Maßangaben in mm.

* für Oberflächen $R_a < 2 \mu\text{m}$

Zugehörige HFS-Wechselkopfhalter ab Seite 460.

Schnittwertempfehlung siehe Kapitelende.

HPR-Wechselkopffreibahle

Feste Ausführung, gerade genutet, für Grundbohrung
HPR180

Ausführung:

Reibahldurchmesser: 7,000 - 21,290 mm
Anschnitt: MC1G
Schneidstoff: HP421
Hartmetall
PVD-beschichtet

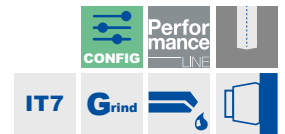
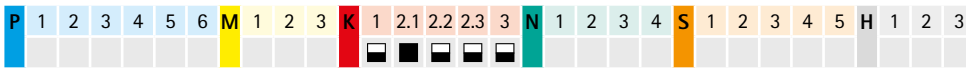
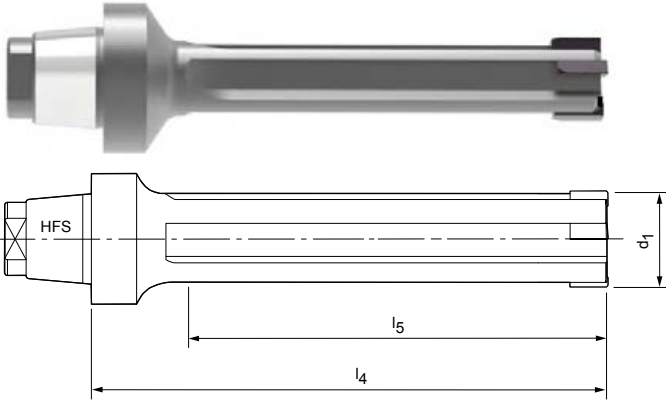

Konfigurierbare Merkmale



Bohrungsdurchmesser Toleranz IT7:

- Durchmesser in Abstufungen von 0,001 mm frei wählbar
- Ab Toleranz IT7 bestellbar

Spezifikation:

HPR180Ø[Durchmesser][Toleranz]MC1G-HP421

Bohrungsdurchmesser Toleranz < IT7:

- Toleranzen kleiner IT7 als spezieller Werkzeugdurchmesser bestellbar (G-Variante siehe Seite 373)

Spezifikation G-Variante:

HPR180GØ[Durchmesser][Toleranz]MC1G-HP421

Abmessungen konfigurierbare Baureihe IT7

d1	l4	l5	HFS-Größe	z
7,000 - 14,590	60	40	12	4
14,600 - 21,290	60	40	12	6

Beispiel Toleranz IT7:

HPR180Ø16.350H7MC1G-HP421

Bohrungsdurchmesser $d_1 = 16,350 \text{ H7}$

Beispiel G-Variante:

HPR180GØ16.350-5MC1G-HP421

Spezieller Werkzeugdurchmesser $d_1 = 16,350 -5 \mu\text{m}$

Maßangaben in mm.

Zugehörige HFS-Wechselkopfhalter ab Seite 460.

Schnittwertempfehlung siehe Kapitelende.

HPR-Wechselkopffreibahle

Feste Ausführung, gerade genutet, für Grundbohrung
HPR180

Ausführung:

Reibahldurchmesser: 7,000 - 21,290 mm
Anschnitt: MC1G
Schneidstoff: HP423
Hartmetall
PVD-beschichtet

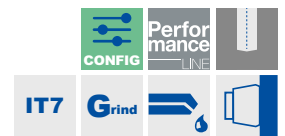
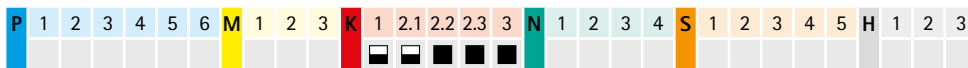
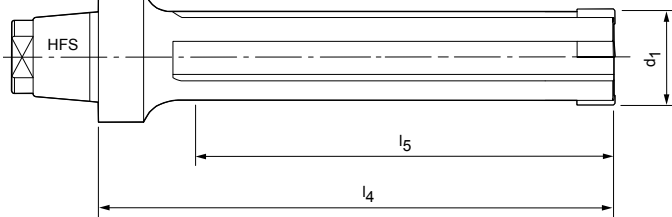

Konfigurierbare Merkmale



Bohrungsdurchmesser Toleranz IT7:

- Durchmesser in Abstufungen von 0,001 mm frei wählbar
- Ab Toleranz IT7 bestellbar

Spezifikation:

HPR180Ø[Durchmesser][Toleranz]MC1G-HP423

Bohrungsdurchmesser Toleranz < IT7:

- Toleranzen kleiner IT7 als spezieller Werkzeugdurchmesser bestellbar (G-Variante siehe Seite 373)

Spezifikation G-Variante:

HPR180GØ[Durchmesser][Toleranz]MC1G-HP423

Abmessungen konfigurierbare Baureihe IT7

d1	l4	l5	HFS-Größe	z
7,000 - 14,590	60	40	12	4
14,600 - 21,290	60	40	12	6

Beispiel Toleranz IT7:

HPR180Ø16.350H7MC1G-HP423

Bohrungsdurchmesser $d_1 = 16,350 \text{ H7}$

Beispiel G-Variante:

HPR180GØ16.350-8MC1G-HP423

Spezieller Werkzeugdurchmesser $d_1 = 16,350 -7 \mu\text{m}$

Maßangaben in mm.

Zugehörige HFS-Wechselkopfhalter ab Seite 460.

Schnittwertempfehlung siehe Kapitelende.

HPR-Wechselkopffreibahle

Feste Ausführung, gerade genutet, für Grundbohrung
HPR180

Ausführung:

Reibahldurchmesser: 7,000 - 21,290 mm
Anschnitt: MA0A
Schneidstoff: PU620
PKD-bestückt

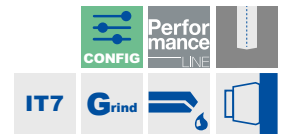
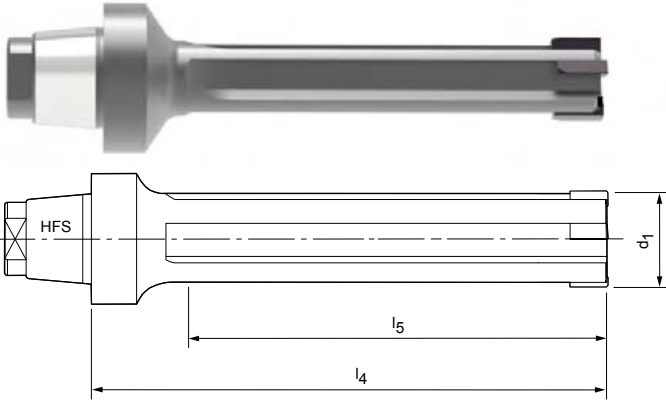

Konfigurierbare Merkmale



Bohrungsdurchmesser Toleranz IT7:

- Durchmesser in Abstufungen von 0,001 mm frei wählbar
- Ab Toleranz IT7 bestellbar

Spezifikation:

HPR180Ø[Durchmesser][Toleranz]MA0A-PU620

Bohrungsdurchmesser Toleranz < IT7:

- Toleranzen kleiner IT7 als spezieller Werkzeugdurchmesser bestellbar (G-Variante siehe Seite 373)

Spezifikation G-Variante:

HPR180GØ[Durchmesser][Toleranz]MA0A-PU620

Abmessungen konfigurierbare Baureihe IT7

d1	l ₄	l ₅	HFS-Größe	z
7,000 - 14,590	60	40	12	4
14,600 - 21,290	60	40	12	6

Beispiel Toleranz IT7:

HPR180Ø16.350H7MA0A-PU620

Bohrungsdurchmesser d₁ = 16,350 H7

Beispiel G-Variante:

HPR180GØ16.350-3MA0A-PU620

Spezieller Werkzeugdurchmesser d₁ = 16,350 -3 µm

Maßangaben in mm.

Zugehörige HFS-Wechselkopfhalter ab Seite 460.

Schnittwertempfehlung siehe Kapitelende.

HPR-Wechselkopffreibahle

Feste Ausführung, gerade genutet, für Grundbohrung
HPR180

Ausführung:

Reibahldurchmesser: 7,000 - 21,290 mm
 Anschnitt: M02G
 Schneidstoff: HP612
 Hartmetall
 PVD-beschichtet

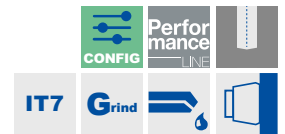
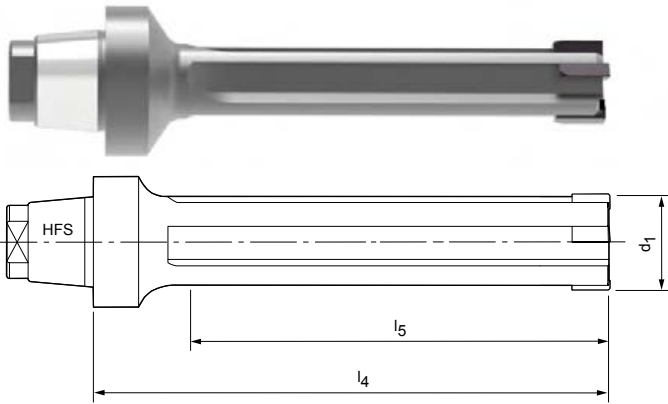

Konfigurierbare Merkmale



Bohrungsdurchmesser Toleranz IT7:

- Durchmesser in Abstufungen von 0,001 mm frei wählbar
- Ab Toleranz IT7 bestellbar

Spezifikation:

HPR180Ø[Durchmesser][Toleranz]M02G-HP612

Bohrungsdurchmesser Toleranz < IT7:

- Toleranzen kleiner IT7 als spezieller Werkzeugdurchmesser bestellbar (G-Variante siehe Seite 373)

Spezifikation G-Variante:

HPR180GØ[Durchmesser][Toleranz]M02G-HP612

Abmessungen konfigurierbare Baureihe IT7

d1	l4	l5	HFS-Größe	z
7,000 - 14,590	60	40	12	4
14,600 - 21,290	60	40	12	6

Beispiel Toleranz IT7:

HPR180Ø16.350H7M02G-HP612

Bohrungsdurchmesser d₁ = 16,350 H7

Beispiel G-Variante:

HPR180GØ16.350-7M02G-HP612

Spezieller Werkzeugdurchmesser d₁ = 16,350 -7 µm

Maßangaben in mm.

Zugehörige HFS-Wechselkopfhalter ab Seite 460.

Schnittwertempfehlung siehe Kapitelende.

HPR-Wechselkopfreibahle

Feste Ausführung, gerade genutet, für Grundbohrung
HPR150

Ausführung:

Reibahle Durchmesser: 16,600 - 65,000 mm
Anschnitt: ML2G
Schneidstoff: CU134
Cermet unbeschichtet

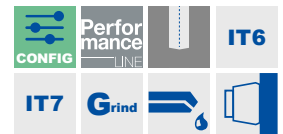
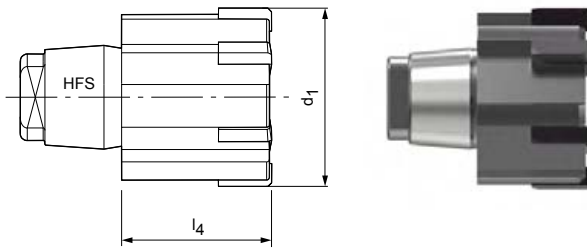

Konfigurierbare Merkmale

Bohrungsdurchmesser Toleranz IT6/IT7:

- Durchmesser in Abstufungen von 0,001 mm frei wählbar
- Abhängig vom Durchmesserbereich ab Toleranz IT6/IT7 bestellbar
- > Ø30,000 IT6 | ≤ Ø30,000 IT7

Spezifikation:

HPR150Ø[Durchmesser][Toleranz]ML2G-CU134

Bohrungsdurchmesser Toleranz < IT6/IT7:

- Toleranzen kleiner IT6/IT7 als spezieller Werkzeugdurchmesser bestellbar (G-Variante siehe Seite 373)

Spezifikation G-Variante:

HPR150GØ[Durchmesser][Toleranz]ML2G-CU134

Abmessungen konfigurierbare Baureihe IT6/IT7

d1	l ₄	l ₅	HFS-Größe	z	Toleranz
16,600 - 21,290	14	-	10	6	IT7
21,300 - 24,990	15,5	-	12	6	IT7
25,000 - 28,990	15,5	-	14	6	IT7
29,000 - 29,990	17	-	16	6	IT7
30,000 - 36,990	17	-	16	6	IT6
37,000 - 44,990	17	-	20	8	IT6
45,000 - 50,700	19	-	24	8	IT6
50,710 - 65,000	25	-	24	8	IT6

Beispiel Toleranz IT6:

HPR150Ø37.350H6ML2G-CU134

Bohrungsdurchmesser d₁ = 37,350 H6

Beispiel G-Variante:

HPR150GØ37.350-3ML2G-CU134

Spezieller Werkzeugdurchmesser d₁ = 37,350 -3 µm

Maßangaben in mm.

Zugehörige HFS-Wechselkopfhalter ab Seite 460.

Schnittwertempfehlung siehe Kapitelende.

HPR-Wechselkopfreibahle

Feste Ausführung, gerade genutet, für Grundbohrung
HPR150

Ausführung:

Reibahldurchmesser: 16,600 - 65,000 mm
 Anschnitt: ML2G
 Schneidstoff: HP421
 Hartmetall
 PVD-beschichtet

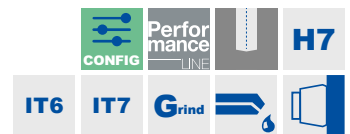
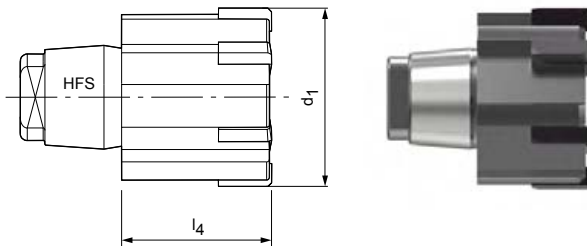
Lagerhaltige Vorzugsbaureihe in H7

d ₁ H7	HFS-Größe	Baumaße		Spezifikation	Bestell-Nr.
		l ₄	z		
22,000	12	15,5	6	HPR150Ø22H7ML2G-HP421	30098915
24,000	12	15,5	6	HPR150Ø24H7ML2G-HP421	30329443
26,000	12	15,5	6	HPR150Ø26H7ML2G-HP421	30044823
28,000	12	15,5	6	HPR150Ø28H7ML2G-HP421	30710391
30,000	16	17	6	HPR150Ø30H7ML2G-HP421	30710393
32,000	16	17	6	HPR150Ø32H7ML2G-HP421	30462441
40,000	16	17	8	HPR150Ø40H7ML2G-HP421	30586834

Konfigurierbare Merkmale

Bohrungsdurchmesser Toleranz IT6/IT7:

- Durchmesser in Abstufungen von 0,001 mm frei wählbar
- Abhängig vom Durchmesserbereich ab Toleranz IT6/IT7 bestellbar
- > Ø30,000 IT6 | ≤ Ø30,000 IT7

Spezifikation:

HPR150Ø[Durchmesser][Toleranz]ML2G-HP421

Bohrungsdurchmesser Toleranz < IT6/IT7:

- Toleranzen kleiner IT6/IT7 als spezieller Werkzeugdurchmesser bestellbar (G-Variante siehe Seite 373)

Spezifikation G-Variante:

HPR150GØ[Durchmesser][Toleranz]ML2G-HP421

Abmessungen konfigurierbare Baureihe IT6/IT7

d ₁	l ₄	l ₅	HFS-Größe	z	Toleranz
16,600 - 21,290	14	-	10	6	IT7
21,300 - 24,990	15,5	-	12	6	IT7
25,000 - 28,990	15,5	-	14	6	IT7
29,000 - 29,990	17	-	16	6	IT7
30,000 - 36,990	17	-	16	6	IT6
37,000 - 44,990	17	-	20	8	IT6
45,000 - 50,700	19	-	24	8	IT6
50,710 - 65,000	25	-	24	8	IT6

Beispiel Toleranz IT6:

HPR150Ø37.350H6ML2G-HP421

Bohrungsdurchmesser d₁ = 37,350 H6

Beispiel G-Variante:

HPR150GØ37.350-5ML2G-HP421

Spezieller Werkzeugdurchmesser d₁ = 37,350 -5 µm

Maßangaben in mm.

Zugehörige HFS-Wechselkopfhalter ab Seite 460.

Schnittwertempfehlung siehe Kapitelende.

HPR-Wechselkopfreibahle

Feste Ausführung, gerade genutet, für Grundbohrung
HPR150

Ausführung:

Reibahldurchmesser: 16,600 - 65,000 mm
Anschnitt: M02G
Schneidstoff: HP421
Hartmetall
PVD-beschichtet

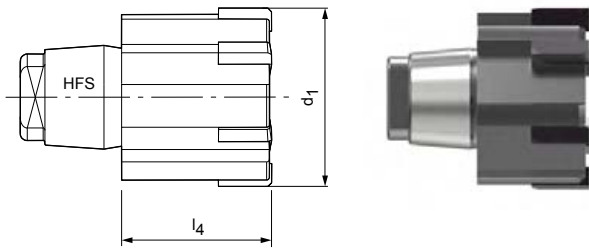

Lagerhaltige Vorzugsbaureihe in H7

d ₁ H7	HFS-Größe	Baumaße		Spezifikation	Bestell-Nr.
		l ₄	z		
20,000	10	14	6	HPR150Ø20H7M02G-HP421	30975790
26,000	14	15,5	6	HPR150Ø26H7M02G-HP421	30975773
28,000	14	15,5	6	HPR150Ø28H7M02G-HP421	30843363
30,000	16	17	6	HPR150Ø30H7M02G-HP421	30975775
32,000	16	17	6	HPR150Ø32H7M02G-HP421	30975776
35,000	16	17	6	HPR150Ø35H7M02G-HP421	30976284
40,000	20	17	8	HPR150Ø40H7M02G-HP421	30898813

Konfigurierbare Merkmale



Bohrungsdurchmesser Toleranz IT6/IT7:

- Durchmesser in Abstufungen von 0,001 mm frei wählbar
- Abhängig vom Durchmesserbereich ab Toleranz IT6/IT7 bestellbar
- > Ø30,000 IT6 | ≤ Ø30,000 IT7

Spezifikation:

HPR150Ø[Durchmesser][Toleranz]M02G-HP421

Bohrungsdurchmesser Toleranz < IT6/IT7:

- Toleranzen kleiner IT6/IT7 als spezieller Werkzeugdurchmesser bestellbar (G-Variante siehe Seite 373)

Spezifikation G-Variante:

HPR150GØ[Durchmesser][Toleranz]M02G-HP421

Abmessungen konfigurierbare Baureihe IT6/IT7

d ₁	l ₄	l ₅	HFS-Größe	z	Toleranz
16,600 - 21,290	14	-	10	6	IT7
21,300 - 24,990	15,5	-	12	6	IT7
25,000 - 28,990	15,5	-	14	6	IT7
29,000 - 29,990	17	-	16	6	IT7
30,000 - 36,990	17	-	16	6	IT6
37,000 - 44,990	17	-	20	8	IT6
45,000 - 50,700	19	-	24	8	IT6
50,710 - 65,000	25	-	24	8	IT6

Beispiel Toleranz IT6:

HPR150Ø37.350H6M02G-HP421

Bohrungsdurchmesser d₁ = 37,350 H6

Beispiel G-Variante:

HPR150GØ37.350-5M02G-HP421

Spezieller Werkzeugdurchmesser d₁ = 37,350 -5 µm

Maßangaben in mm.

Zugehörige HFS-Wechselkopfhalter ab Seite 460.

Schnittwertempfehlung siehe Kapitelende.

HPR-Wechselkopfreibahle

Feste Ausführung, gerade genutet, für Grundbohrung
HPR150

Ausführung:

Reibahldurchmesser: 16,600 - 65,000 mm
 Anschnitt: MC1G
 Schneidstoff: CP134
 Cermet
 PVD-beschichtet

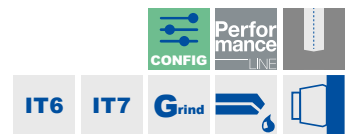
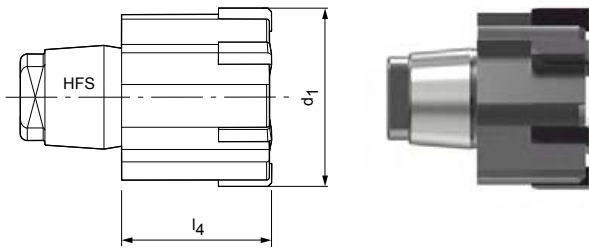

Konfigurierbare Merkmale

Bohrungsdurchmesser Toleranz IT6/IT7:

- Durchmesser in Abstufungen von 0,001 mm frei wählbar
- Abhängig vom Durchmesserbereich ab Toleranz IT6/IT7 bestellbar
- > Ø30,000 IT6 | ≤ Ø30,000 IT7

Spezifikation:
HPR150Ø[Durchmesser][Toleranz]MC1G-CP134

Bohrungsdurchmesser Toleranz < IT6/IT7:

- Toleranzen kleiner IT6/IT7 als spezieller Werkzeugdurchmesser bestellbar (G-Variante siehe Seite 373)

Spezifikation G-Variante:
HPR150GØ[Durchmesser][Toleranz]MC1G-CP134

Abmessungen konfigurierbare Baureihe IT6/IT7

d1	l4	l5	HFS-Größe	z	Toleranz
16,600 - 21,290	14	-	10	6	IT7
21,300 - 24,990	15,5	-	12	6	IT7
25,000 - 28,990	15,5	-	14	6	IT7
29,000 - 29,990	17	-	16	6	IT7
30,000 - 36,990	17	-	16	6	IT6
37,000 - 44,990	17	-	20	8	IT6
45,000 - 50,700	19	-	24	8	IT6
50,710 - 65,000	25	-	24	8	IT6

Beispiel Toleranz IT6:
HPR150Ø37.350H6MC1G-CP134

Bohrungsdurchmesser d₁ = 37,350 H6

Beispiel G-Variante:
HPR150GØ37.350-5MC1G-CP134

Spezieller Werkzeugdurchmesser d₁ = 37,350 -5 µm

Maßangaben in mm.
 * für Oberflächen R_a < 2 µm
 Zugehörige HFS-Wechselkopfhalter ab Seite 460.
 Schnittwertempfehlung siehe Kapitelende.

HPR-Wechselkopfreibahle

Feste Ausführung, gerade genutet, für Grundbohrung
HPR150

Ausführung:

Reibahlundurchmesser: 16,600 - 65,000 mm
Anschnitt: MC1G
Schneidstoff: HC419
Hartmetall
CVD-beschichtet

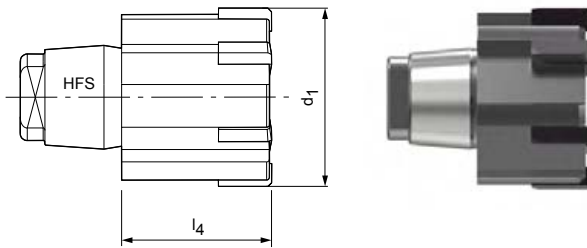

Konfigurierbare Merkmale



Bohrungsdurchmesser Toleranz IT6/IT7:

- Durchmesser in Abstufungen von 0,001 mm frei wählbar
- Abhängig vom Durchmesserbereich ab Toleranz IT6/IT7 bestellbar
- > Ø30,000 IT6 | ≤ Ø30,000 IT7

Spezifikation:

HPR150Ø[Durchmesser][Toleranz]MC1G-HC419

Bohrungsdurchmesser Toleranz < IT6/IT7:

- Toleranzen kleiner IT6/IT7 als spezieller Werkzeugdurchmesser bestellbar (G-Variante siehe Seite 373)

Spezifikation G-Variante:

HPR150GØ[Durchmesser][Toleranz]MC1G-HC419

Abmessungen konfigurierbare Baureihe IT6/IT7

d1	l ₄	l ₅	HFS-Größe	z	Toleranz
16,600 - 21,290	14	-	10	6	IT7
21,300 - 24,990	15,5	-	12	6	IT7
25,000 - 28,990	15,5	-	14	6	IT7
29,000 - 29,990	17	-	16	6	IT7
30,000 - 36,990	17	-	16	6	IT6
37,000 - 44,990	17	-	20	8	IT6
45,000 - 50,700	19	-	24	8	IT6
50,710 - 65,000	25	-	24	8	IT6

Beispiel Toleranz IT6:

HPR150Ø37.350H6MC1G-HC419

Bohrungsdurchmesser d₁ = 37,350 H6

Beispiel G-Variante:

HPR150GØ37.350-7MC1G-HC419

Spezieller Werkzeugdurchmesser d₁ = 37,350 -7 µm

Maßangaben in mm.

* für Oberflächen R_a > 2 µm

Zugehörige HFS-Wechselkopfhalter ab Seite 460.

Schnittwertempfehlung siehe Kapitelende.

HPR-Wechselkopfreibahle

Feste Ausführung, gerade genutet, für Grundbohrung
HPR150

Ausführung:

Reibahldurchmesser: 16,600 - 65,000 mm
Anschnitt: MC1G
Schneidstoff: HP421
Hartmetall
PVD-beschichtet

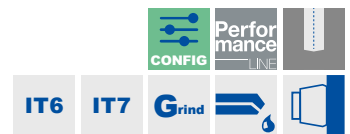
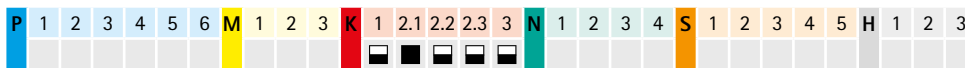
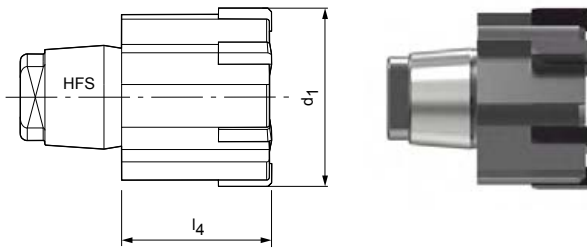

Konfigurierbare Merkmale



Bohrungsdurchmesser Toleranz IT6/IT7:

- Durchmesser in Abstufungen von 0,001 mm frei wählbar
- Abhängig vom Durchmesserbereich ab Toleranz IT6/IT7 bestellbar
- > Ø30,000 IT6 | ≤ Ø30,000 IT7

Spezifikation:

HPR150Ø[Durchmesser][Toleranz]MC1G-HP421

Bohrungsdurchmesser Toleranz < IT6/IT7:

- Toleranzen kleiner IT6/IT7 als spezieller Werkzeugdurchmesser bestellbar (G-Variante siehe Seite 373)

Spezifikation G-Variante:

HPR150GØ[Durchmesser][Toleranz]MC1G-HP421

Abmessungen konfigurierbare Baureihe IT6/IT7

d1	l4	l5	HFS-Größe	z	Toleranz
16,600 - 21,290	14	-	10	6	IT7
21,300 - 24,990	15,5	-	12	6	IT7
25,000 - 28,990	15,5	-	14	6	IT7
29,000 - 29,990	17	-	16	6	IT7
30,000 - 36,990	17	-	16	6	IT6
37,000 - 44,990	17	-	20	8	IT6
45,000 - 50,700	19	-	24	8	IT6
50,710 - 65,000	25	-	24	8	IT6

Beispiel Toleranz IT6:

HPR150Ø37.350H6MC1G-HP421

Bohrungsdurchmesser $d_1 = 37,350 \text{ H6}$

Beispiel G-Variante:

HPR150GØ37.350-5MC1G-HP421

Spezieller Werkzeugdurchmesser $d_1 = 37,350 -5 \mu\text{m}$

HPR-Wechselkopfreibahle

Feste Ausführung, gerade genutet, für Grundbohrung
HPR150

Ausführung:

Reibahlundurchmesser: 16,600 - 65,000 mm
Anschnitt: MC1G
Schneidstoff: HP423
Hartmetall
PVD-beschichtet

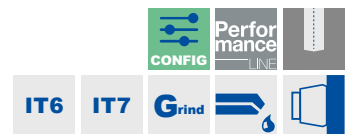
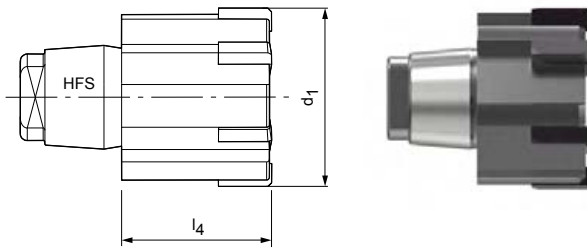

Konfigurierbare Merkmale



Bohrungsdurchmesser Toleranz IT6/IT7:

- Durchmesser in Abstufungen von 0,001 mm frei wählbar
- Abhängig vom Durchmesserbereich ab Toleranz IT6/IT7 bestellbar
- > Ø30,000 IT6 | ≤ Ø30,000 IT7

Spezifikation:

HPR150Ø[Durchmesser][Toleranz]MC1G-HP423

Bohrungsdurchmesser Toleranz < IT6/IT7:

- Toleranzen kleiner IT6/IT7 als spezieller Werkzeugdurchmesser bestellbar (G-Variante siehe Seite 373)

Spezifikation G-Variante:

HPR150GØ[Durchmesser][Toleranz]MC1G-HP423

Abmessungen konfigurierbare Baureihe IT6/IT7

d1	l4	l5	HFS-Größe	z	Toleranz
16,600 - 21,290	14	-	10	6	IT7
21,300 - 24,990	15,5	-	12	6	IT7
25,000 - 28,990	15,5	-	14	6	IT7
29,000 - 29,990	17	-	16	6	IT7
30,000 - 36,990	17	-	16	6	IT6
37,000 - 44,990	17	-	20	8	IT6
45,000 - 50,700	19	-	24	8	IT6
50,710 - 65,000	25	-	24	8	IT6

Beispiel Toleranz IT6:

HPR150Ø37.350H6MC1G-HP423

Bohrungsdurchmesser $d_1 = 37,350 \text{ H6}$

Beispiel G-Variante:

HPR150GØ37.350-8MC1G-HP423

Spezieller Werkzeugdurchmesser $d_1 = 37,350 -7 \mu\text{m}$

Maßangaben in mm.

Zugehörige HFS-Wechselkopfhalter ab Seite 460.

Schnittwertempfehlung siehe Kapitelende.

HPR-Wechselkopfreibahle

Feste Ausführung, gerade genutet, für Grundbohrung
HPR150

Ausführung:

Reibahldurchmesser: 16,600 - 65,000 mm
 Anschnitt: MA0A
 Schneidstoff: PU620
 PKD-bestückt

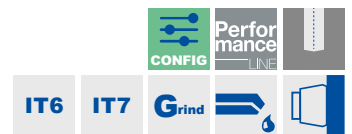
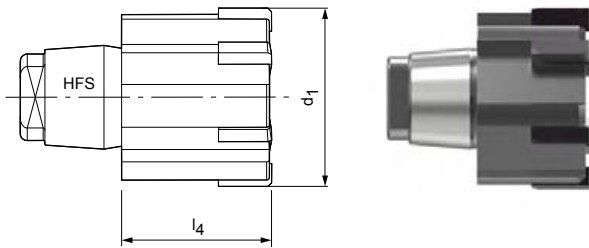

Konfigurierbare Merkmale



Bohrungsdurchmesser Toleranz IT6/IT7:

- Durchmesser in Abstufungen von 0,001 mm frei wählbar
- Abhängig vom Durchmesserbereich ab Toleranz IT6/IT7 bestellbar
- > Ø30,000 IT6 | ≤ Ø30,000 IT7

Spezifikation:

HPR150Ø[Durchmesser][Toleranz]MA0A-PU620

Bohrungsdurchmesser Toleranz < IT6/IT7:

- Toleranzen kleiner IT6/IT7 als spezieller Werkzeugdurchmesser bestellbar (G-Variante siehe Seite 373)

Spezifikation G-Variante:

HPR150GØ[Durchmesser][Toleranz]MA0A-PU620

Abmessungen konfigurierbare Baureihe IT6/IT7

d1	l4	l5	HFS-Größe	z	Toleranz
16,600 - 21,290	14	-	10	6	IT7
21,300 - 24,990	15,5	-	12	6	IT7
25,000 - 28,990	15,5	-	14	6	IT7
29,000 - 29,990	17	-	16	6	IT7
30,000 - 36,990	17	-	16	6	IT6
37,000 - 44,990	17	-	20	8	IT6
45,000 - 50,700	19	-	24	8	IT6
50,710 - 65,000	25	-	24	8	IT6

Beispiel Toleranz IT6:

HPR150Ø37.350H6MA0A-PU620

Bohrungsdurchmesser d₁ = 37,350 H6

Beispiel G-Variante:

HPR150GØ37.350-3MA0A-PU620

Spezieller Werkzeugdurchmesser d₁ = 37,350 -3 µm

Maßangaben in mm.

Zugehörige HFS-Wechselkopfhalter ab Seite 460.

Schnittwertempfehlung siehe Kapitelende.

HPR-Wechselkopfreibahle

Feste Ausführung, gerade genutet, für Grundbohrung
HPR150

Ausführung:

Reibahlundurchmesser: 16,600 - 65,000 mm
Anschnitt: M02G
Schneidstoff: HP612
Hartmetall
PVD-beschichtet

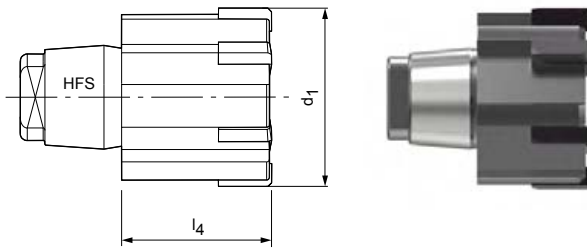

Konfigurierbare Merkmale



Bohrungsdurchmesser Toleranz IT6/IT7:

- Durchmesser in Abstufungen von 0,001 mm frei wählbar
- Abhängig vom Durchmesserbereich ab Toleranz IT6/IT7 bestellbar
- > Ø30,000 IT6 | ≤ Ø30,000 IT7

Spezifikation:

HPR150Ø[Durchmesser][Toleranz]M02G-HP612

Bohrungsdurchmesser Toleranz < IT6/IT7:

- Toleranzen kleiner IT6/IT7 als spezieller Werkzeugdurchmesser bestellbar (G-Variante siehe Seite 373)

Spezifikation G-Variante:

HPR150GØ[Durchmesser][Toleranz]M02G-HP612

Abmessungen konfigurierbare Baureihe IT6/IT7

d1	l ₄	l ₅	HFS-Größe	z	Toleranz
16,600 - 21,290	14	-	10	6	IT7
21,300 - 24,990	15,5	-	12	6	IT7
25,000 - 28,990	15,5	-	14	6	IT7
29,000 - 29,990	17	-	16	6	IT7
30,000 - 36,990	17	-	16	6	IT6
37,000 - 44,990	17	-	20	8	IT6
45,000 - 50,700	19	-	24	8	IT6
50,710 - 65,000	25	-	24	8	IT6

Beispiel Toleranz IT6:

HPR150Ø37.350H6M02G-HP612

Bohrungsdurchmesser d₁ = 37,350 H6

Beispiel G-Variante:

HPR150GØ37.350-7M02G-HP612

Spezieller Werkzeugdurchmesser d₁ = 37,350 -7 µm

Maßangaben in mm.

Zugehörige HFS-Wechselkopfhalter ab Seite 460.

Schnittwertempfehlung siehe Kapitelende.

HPR-Wechselkopffreibahle

Feinjustierbare Ausführung, gerade genutet, für Durchgangsbohrung
HPR230

Ausführung:

Reibahldurchmesser: 7,000 - 18,590 mm
 Anschnitt: MC1G
 Schneidstoff: CP134
 Cermet
 PVD-beschichtet

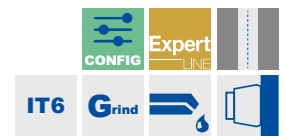
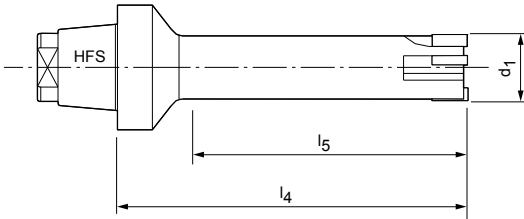

Konfigurierbare Merkmale



Bohrungsdurchmesser Toleranz IT6:

- Durchmesser in Abstufungen von 0,001 mm frei wählbar
- In Toleranz IT6 bestellbar

Spezifikation:

HPR230Ø[Durchmesser][Toleranz]MC1G-CP134

Bohrungsdurchmesser Toleranz < IT6:

- Toleranzen kleiner IT6 als spezieller Werkzeugdurchmesser bestellbar (G-Variante siehe Seite 373)

Spezifikation G-Variante:

HPR230GØ[Durchmesser][Toleranz]MC1G-CP134

Abmessungen konfigurierbare Baureihe IT6

d ₁	l ₄	l ₅	HFS-Größe	z
7,000 - 9,590	60	45	12	4
9,600 - 18,590	60	45	12	6

Beispiel Toleranz IT6:

HPR230Ø10.350H6MC1G-CP134

Bohrungsdurchmesser d₁ = 10,350 H6

Beispiel G-Variante:

HPR230GØ10.350+1-1MC1G-CP134

Spezieller Werkzeugdurchmesser d₁ = 10,350 +1 µm -1 µm

Maßangaben in mm.

* für Oberflächen R_a < 2 µm

Zugehörige HFS-Wechselkopfhalter ab Seite 460.

Schnittwertempfehlung siehe Kapitelende.

HPR-Wechselkopffreibahle

Feinjustierbare Ausführung, gerade genutet, für Durchgangsbohrung
HPR230

Ausführung:

Reibahldurchmesser: 7,000 - 18,590 mm
Anschnitt: MC1G
Schneidstoff: HP421
Hartmetall
PVD-beschichtet

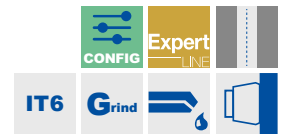
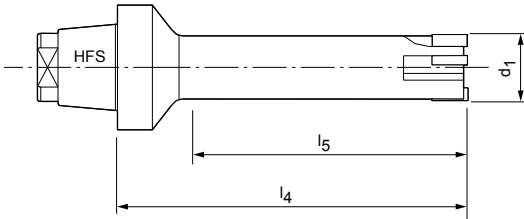

Konfigurierbare Merkmale



Bohrungsdurchmesser Toleranz IT6:

- Durchmesser in Abstufungen von 0,001 mm frei wählbar
- In Toleranz IT6 bestellbar

Spezifikation:

HPR230Ø[Durchmesser][Toleranz]MC1G-HP421

Bohrungsdurchmesser Toleranz < IT6:

- Toleranzen kleiner IT6 als spezieller Werkzeugdurchmesser bestellbar (G-Variante siehe Seite 373)

Spezifikation G-Variante:

HPR230GØ[Durchmesser][Toleranz]MC1G-HP421

Abmessungen konfigurierbare Baureihe IT6

d_1	l_4	l_5	HFS-Größe	z
7,000 - 9,590	60	45	12	4
9,600 - 18,590	60	45	12	6

Beispiel Toleranz IT6:

HPR230Ø10.350H6MC1G-HP421

Bohrungsdurchmesser $d_1 = 10,350 \text{ H6}$

Beispiel G-Variante:

HPR230GØ10.350+1-1MC1G-HP421

Spezieller Werkzeugdurchmesser $d_1 = 10,350 + 1 \mu\text{m} - 1 \mu\text{m}$

Maßangaben in mm.

Zugehörige HFS-Wechselkopfhalter ab Seite 460.

Schnittwertempfehlung siehe Kapitelende.

HPR-Wechselkopfreibahle

Feinjustierbare Ausführung, gerade genutet, für Durchgangsbohrung
HPR230

Ausführung:

Reibahldurchmesser: 7,000 - 18,590 mm
 Anschnitt: MC1G
 Schneidstoff: HP423
 Hartmetall
 PVD-beschichtet

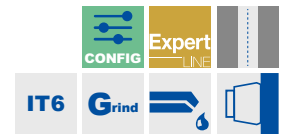
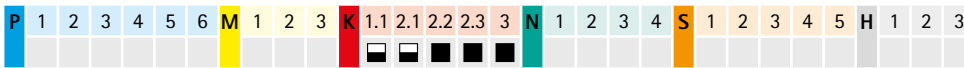
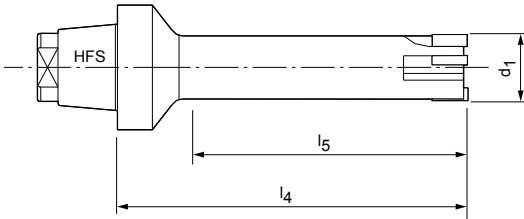

Konfigurierbare Merkmale



Bohrungsdurchmesser Toleranz IT6:

- Durchmesser in Abstufungen von 0,001 mm frei wählbar
- In Toleranz IT6 bestellbar

Spezifikation:

HPR230Ø[Durchmesser][Toleranz]MC1G-HP423

Bohrungsdurchmesser Toleranz < IT6:

- Toleranzen kleiner IT6 als spezieller Werkzeugdurchmesser bestellbar (G-Variante siehe Seite 373)

Spezifikation G-Variante:

HPR230GØ[Durchmesser][Toleranz]MC1G-HP423

Abmessungen konfigurierbare Baureihe IT6

d ₁	l ₄	l ₅	HFS-Größe	z
7,000 - 9,590	60	45	12	4
9,600 - 18,590	60	45	12	6

Beispiel Toleranz IT6:

HPR230Ø10.350H6MC1G-HP423

Bohrungsdurchmesser d₁ = 10,350 H6

Beispiel G-Variante:

HPR230GØ10.350+1-1MC1G-HP423

Spezieller Werkzeugdurchmesser d₁ = 10,350 +1 µm -1 µm

Maßangaben in mm.

Zugehörige HFS-Wechselkopfhalter ab Seite 460.

Schnittwertempfehlung siehe Kapitelende.

HPR-Wechselkopffreibahle

Feinjustierbare Ausführung, gerade genutet, für Durchgangsbohrung
HPR230

Ausführung:

Reibahldurchmesser: 7,000 - 18,590 mm
Anschnitt: MA0A
Schneidstoff: PU620
PKD-bestückt

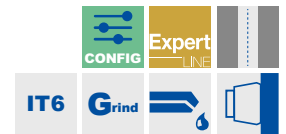
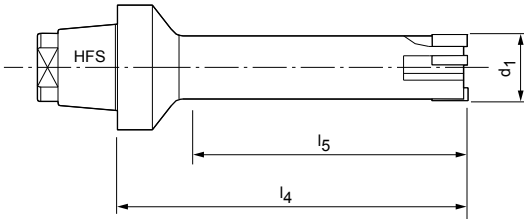

Konfigurierbare Merkmale



Bohrungsdurchmesser Toleranz IT6:

- Durchmesser in Abstufungen von 0,001 mm frei wählbar
- In Toleranz IT6 bestellbar

Spezifikation:

HPR230Ø[Durchmesser][Toleranz]MA0A-PU620

Bohrungsdurchmesser Toleranz < IT6:

- Toleranzen kleiner IT6 als spezieller Werkzeugdurchmesser bestellbar (G-Variante siehe Seite 373)

Spezifikation G-Variante:

HPR230GØ[Durchmesser][Toleranz]MA0A-PU620

Abmessungen konfigurierbare Baureihe IT6

d_1	l_4	l_5	HFS-Größe	z
7,000 - 9,590	60	45	12	4
9,600 - 18,590	60	45	12	6

Beispiel Toleranz IT6:

HPR230Ø10.350H6MA0A-PU620

Bohrungsdurchmesser $d_1 = 10,350 \text{ H6}$

Beispiel G-Variante:

HPR230GØ10.350+1-1MA0A-PU620

Spezieller Werkzeugdurchmesser $d_1 = 10,350 + 1 \mu\text{m} - 1 \mu\text{m}$

Maßangaben in mm.

Zugehörige HFS-Wechselkopfhalter ab Seite 460.

Schnittwertempfehlung siehe Kapitelende.

HPR-Wechselkopffreibahle

Feinjustierbare Ausführung, linksschräg genutet, für Durchgangsbohrung
HPR231

Ausführung:

Reibahlerdurchmesser: 7,000 - 18,590 mm
 Anschnitt: ME1G
 Schneidstoff: CU134
 Cermet unbeschichtet

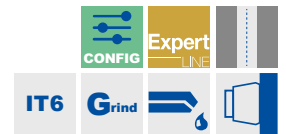
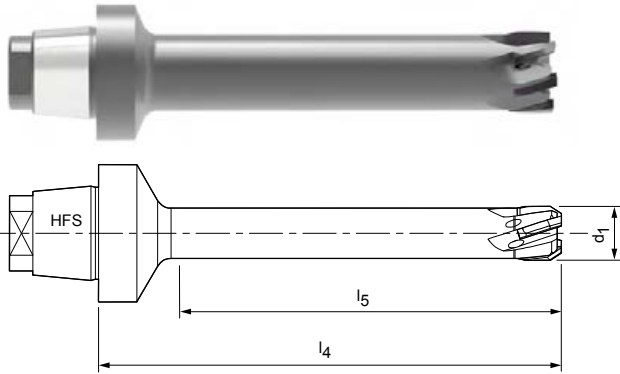

Konfigurierbare Merkmale



Bohrungsdurchmesser Toleranz IT6:

- Durchmesser in Abstufungen von 0,001 mm frei wählbar
- In Toleranz IT6 bestellbar

Spezifikation:

HPR231Ø[Durchmesser][Toleranz]ME1G-CU134

Bohrungsdurchmesser Toleranz < IT6:

- Toleranzen kleiner IT6 als spezieller Werkzeugdurchmesser bestellbar (G-Variante siehe Seite 373)

Spezifikation G-Variante:

HPR231GØ[Durchmesser][Toleranz]ME1G-CU134

Abmessungen konfigurierbare Baureihe IT6

d ₁	l ₄	l ₅	HFS-Größe	z
7,000 - 9,590	60	45	12	4
9,600 - 18,590	60	45	12	6

Beispiel Toleranz IT6:

HPR231Ø10.350H6ME1G-CU134

Bohrungsdurchmesser d₁ = 10,350 H6

Beispiel G-Variante:

HPR231GØ10.350+1-1ME1G-CU134

Spezieller Werkzeugdurchmesser d₁ = 10,350 +1 µm -1 µm

Maßangaben in mm.

Zugehörige HFS-Wechselkopfhalter ab Seite 460.

Schnittwertempfehlung siehe Kapitelende.

HPR-Wechselkopffreibahle

Feinjustierbare Ausführung, linksschräg genutet, für Durchgangsbohrung
HPR231

Ausführung:

Reibahlerdurchmesser: 7,000 - 18,590 mm
Anschnitt: ME1G
Schneidstoff: HP421
Hartmetall
PVD-beschichtet

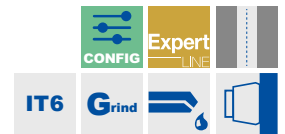
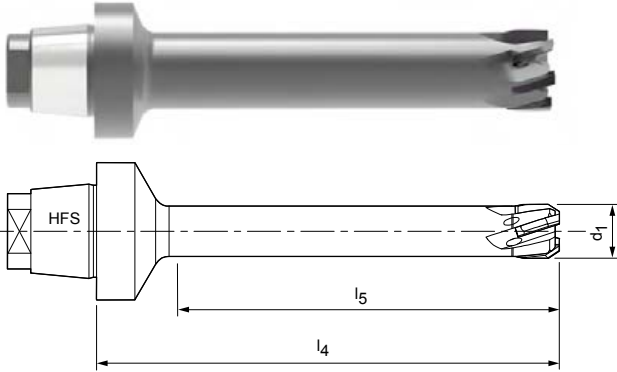

Konfigurierbare Merkmale



Bohrungsdurchmesser Toleranz IT6:

- Durchmesser in Abstufungen von 0,001 mm frei wählbar
- In Toleranz IT6 bestellbar

Spezifikation:

HPR231Ø[Durchmesser][Toleranz]ME1G-HP421

Bohrungsdurchmesser Toleranz < IT6:

- Toleranzen kleiner IT6 als spezieller Werkzeugdurchmesser bestellbar (G-Variante siehe Seite 373)

Spezifikation G-Variante:

HPR231GØ[Durchmesser][Toleranz]ME1G-HP421

Abmessungen konfigurierbare Baureihe IT6

d_1	l_4	l_5	HFS-Größe	z
7,000 - 9,590	60	45	12	4
9,600 - 18,590	60	45	12	6

Beispiel Toleranz IT6:

HPR231Ø10.350H6ME1G-HP421

Bohrungsdurchmesser $d_1 = 10,350 \text{ H6}$

Beispiel G-Variante:

HPR231GØ10.350+1-1ME1G-HP421

Spezieller Werkzeugdurchmesser $d_1 = 10,350 +1 \mu\text{m} -1 \mu\text{m}$

Maßangaben in mm.

Zugehörige HFS-Wechselkopfhalter ab Seite 460.

Schnittwertempfehlung siehe Kapitelende.

HPR-Wechselkopffreibahle

Feinjustierbare Ausführung, linksschräg genutet, für Durchgangsbohrung
HPR231

Ausführung:

Reibahlerdurchmesser: 7,000 - 18,590 mm
 Anschnitt: MF1G
 Schneidstoff: HP421
 Hartmetall
 PVD-beschichtet

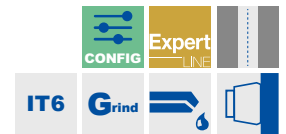
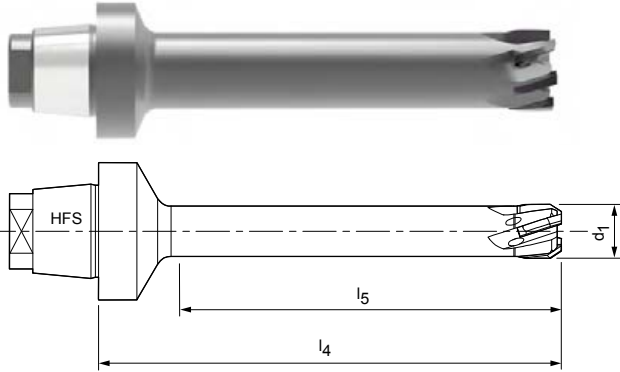

Konfigurierbare Merkmale



Bohrungsdurchmesser Toleranz IT6:

- Durchmesser in Abstufungen von 0,001 mm frei wählbar
- In Toleranz IT6 bestellbar

Spezifikation:

HPR231Ø[Durchmesser][Toleranz]MF1G-HP421

Bohrungsdurchmesser Toleranz < IT6:

- Toleranzen kleiner IT6 als spezieller Werkzeugdurchmesser bestellbar (G-Variante siehe Seite 373)

Spezifikation G-Variante:

HPR231GØ[Durchmesser][Toleranz]MF1G-HP421

Abmessungen konfigurierbare Baureihe IT6

d ₁	l ₄	l ₅	HFS-Größe	z
7,000 - 9,590	60	45	12	4
9,600 - 18,590	60	45	12	6

Beispiel Toleranz IT6:

HPR231Ø10.350H6MF1G-HP421

Bohrungsdurchmesser d₁ = 10,350 H6

Beispiel G-Variante:

HPR231GØ10.350+1-1MF1G-HP421

Spezieller Werkzeugdurchmesser d₁ = 10,350 +1 µm -1 µm

Maßangaben in mm.

Zugehörige HFS-Wechselkopfhalter ab Seite 460.

Schnittwertempfehlung siehe Kapitelende.

HPR-Wechselkopffreibahle

Feinjustierbare Ausführung, linksschräg genutet, für Durchgangsbohrung
HPR231

Ausführung:

Reibahlerdurchmesser: 7,000 - 18,590 mm
Anschnitt: MF1G
Schneidstoff: HP625
Hartmetall
PVD-beschichtet

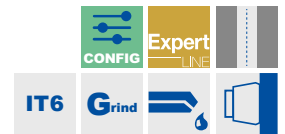
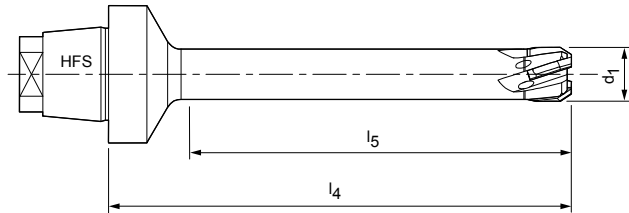

Konfigurierbare Merkmale



Bohrungsdurchmesser Toleranz IT6:

- Durchmesser in Abstufungen von 0,001 mm frei wählbar
- In Toleranz IT6 bestellbar

Spezifikation:

HPR231Ø[Durchmesser][Toleranz]MF1G-HP625

Bohrungsdurchmesser Toleranz < IT6:

- Toleranzen kleiner IT6 als spezieller Werkzeugdurchmesser bestellbar (G-Variante siehe Seite 373)

Spezifikation G-Variante:

HPR231GØ[Durchmesser][Toleranz]MF1G-HP625

Abmessungen konfigurierbare Baureihe IT6

d_1	l_4	l_5	HFS-Größe	z
7,000 - 9,590	60	45	12	4
9,600 - 18,590	60	45	12	6

Beispiel Toleranz IT6:

HPR231Ø10.350H6MF1G-HP625

Bohrungsdurchmesser $d_1 = 10,350 \text{ H6}$

Beispiel G-Variante:

HPR231GØ10.350+1-1MF1G-HP625

Spezieller Werkzeugdurchmesser $d_1 = 10,350 + 1 \mu\text{m} - 1 \mu\text{m}$

Maßangaben in mm.

Zugehörige HFS-Wechselkopfhalter ab Seite 460.

Schnittwertempfehlung siehe Kapitelende.

HPR-Wechselkopfreibahle

Feinjustierbare Ausführung, gerade genutet, für Durchgangsbohrung
HPR200

Ausführung:

Reibahldurchmesser: 18,600 - 65,000 mm
 Anschnitt: MC1G
 Schneidstoff: CP134
 Cermet
 PVD-beschichtet

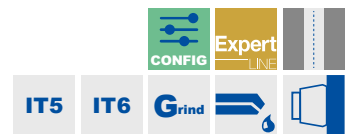
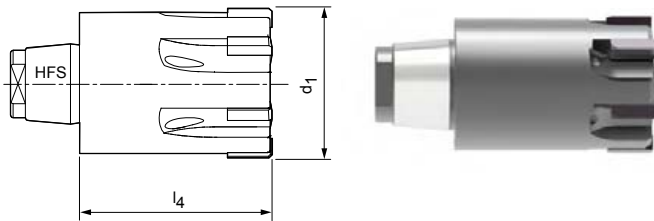

Konfigurierbare Merkmale

Bohrungsdurchmesser Toleranz IT5/IT6:

- Durchmesser in Abstufungen von 0,001 mm frei wählbar
- Abhängig vom Durchmesserbereich ab Toleranz IT5/IT6 bestellbar
- > Ø30,000 IT5 | ≤ Ø30,000 IT6

Spezifikation:

HPR200Ø[Durchmesser][Toleranz]MC1G-CP134

Bohrungsdurchmesser Toleranz < IT5/IT6:

- Toleranzen kleiner IT5/IT6 als spezieller Werkzeugdurchmesser bestellbar (G-Variante siehe Seite 373)

Spezifikation G-Variante:

HPR200GØ[Durchmesser][Toleranz]MC1G-CP134

Abmessungen konfigurierbare Baureihe IT5/IT6

d ₁	l ₄	l ₅	HFS-Größe	z	Toleranz
18,600 - 20,390	25	-	12	6	IT6
20,400 - 21,290	27	-	12	6	IT6
21,300 - 23,990	27	-	14	6	IT6
24,000 - 29,990	35	-	16	6	IT6
30,000 - 39,990	41	-	20	8	IT5
40,000 - 65,000	47	-	24	8	IT5

Beispiel Toleranz IT5:

HPR200Ø35.350H5MC1G-CP134

Bohrungsdurchmesser d₁ = 35,350 H5

Beispiel G-Variante:

HPR200GØ35.350+1-1MC1G-CP134

Spezieller Werkzeugdurchmesser d₁ = 35,350 +1 µm -1 µm

Maßangaben in mm.

* für Oberflächen R_a < 2 µm

Zugehörige HFS-Wechselkopfhalter ab Seite 460.

Schnittwertempfehlung siehe Kapitelende.

HPR-Wechselkopfreibahle

Feinjustierbare Ausführung, gerade genutet, für Durchgangsbohrung
HPR200

Ausführung:

Reibahlundurchmesser: 18,600 - 65,000 mm
Anschnitt: MC1G
Schneidstoff: HP421
Hartmetall
PVD-beschichtet

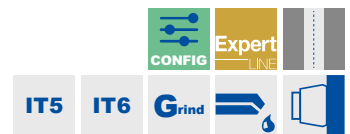
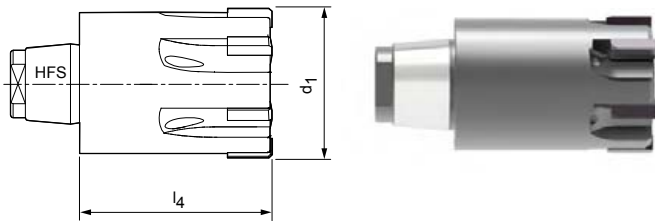

Konfigurierbare Merkmale



Bohrungsdurchmesser Toleranz IT5/IT6:

- Durchmesser in Abstufungen von 0,001 mm frei wählbar
- Abhängig vom Durchmesserbereich ab Toleranz IT5/IT6 bestellbar
- > Ø30,000 IT5 | ≤ Ø30,000 IT6

Spezifikation:

HPR200Ø[Durchmesser][Toleranz]MC1G-HP421

Bohrungsdurchmesser Toleranz < IT5/IT6:

- Toleranzen kleiner IT5/IT6 als spezieller Werkzeugdurchmesser bestellbar (G-Variante siehe Seite 373)

Spezifikation G-Variante:

HPR200GØ[Durchmesser][Toleranz]MC1G-HP421

Abmessungen konfigurierbare Baureihe IT5/IT6

d_1	l_4	l_5	HFS-Größe	z	Toleranz
18,600 - 20,390	25	-	12	6	IT6
20,400 - 21,290	27	-	12	6	IT6
21,300 - 23,990	27	-	14	6	IT6
24,000 - 29,990	35	-	16	6	IT6
30,000 - 39,990	41	-	20	8	IT5
40,000 - 65,000	47	-	24	8	IT5

Beispiel Toleranz IT5:

HPR200Ø35.350H5MC1G-HP421

Bohrungsdurchmesser $d_1 = 35,350 \text{ H5}$

Beispiel G-Variante:

HPR200GØ35.350+1-1MC1G-HP421

Spezieller Werkzeugdurchmesser $d_1 = 35,350 +1 \mu\text{m} -1 \mu\text{m}$

Maßangaben in mm.

Zugehörige HFS-Wechselkopfhalter ab Seite 460.

Schnittwertempfehlung siehe Kapitelende.

HPR-Wechselkopfreibahle

Feinjustierbare Ausführung, gerade genutet, für Durchgangsbohrung
HPR200

Ausführung:

Reibahldurchmesser: 18,600 - 65,000 mm
 Anschnitt: MC1G
 Schneidstoff: HP423
 Hartmetall
 PVD-beschichtet

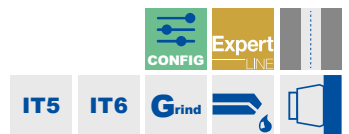
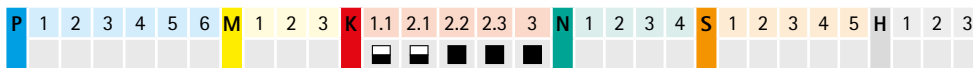
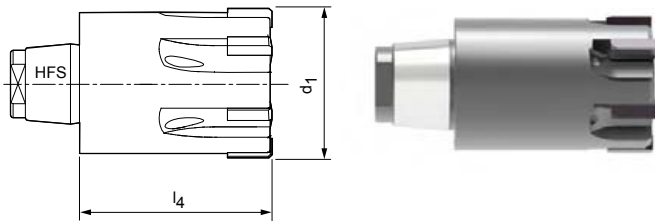

Konfigurierbare Merkmale



Bohrungsdurchmesser Toleranz IT5/IT6:

- Durchmesser in Abstufungen von 0,001 mm frei wählbar
- Abhängig vom Durchmesserbereich ab Toleranz IT5/IT6 bestellbar
- > Ø30,000 IT5 | ≤ Ø30,000 IT6

Spezifikation:

HPR200Ø[Durchmesser][Toleranz]MC1G-HP423

Bohrungsdurchmesser Toleranz < IT5/IT6:

- Toleranzen kleiner IT5/IT6 als spezieller Werkzeugdurchmesser bestellbar (G-Variante siehe Seite 373)

Spezifikation G-Variante:

HPR200GØ[Durchmesser][Toleranz]MC1G-HP423

Abmessungen konfigurierbare Baureihe IT5/IT6

d ₁	l ₄	l ₅	HFS-Größe	z	Toleranz
18,600 - 20,390	25	-	12	6	IT6
20,400 - 21,290	27	-	12	6	IT6
21,300 - 23,990	27	-	14	6	IT6
24,000 - 29,990	35	-	16	6	IT6
30,000 - 39,990	41	-	20	8	IT5
40,000 - 65,000	47	-	24	8	IT5

Beispiel Toleranz IT5:

HPR200Ø35.350H5MC1G-HP423

Bohrungsdurchmesser d₁ = 35,350 H5

Beispiel G-Variante:

HPR200GØ35.350+1-1MC1G-HP423

Spezieller Werkzeugdurchmesser d₁ = 35,350 +1 µm -1 µm

Maßangaben in mm.

Zugehörige HFS-Wechselkopfhalter ab Seite 460.

Schnittwertempfehlung siehe Kapitelende.

HPR-Wechselkopfreibahle

Feinjustierbare Ausführung, gerade genutet, für Durchgangsbohrung
HPR200

Ausführung:

Reibahlundurchmesser: 18,600 - 65,000 mm
 Anschnitt: MA0A
 Schneidstoff: PU620
 PKD-bestückt

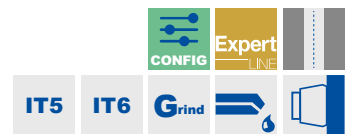
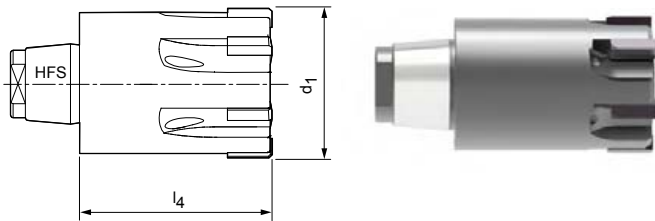

Konfigurierbare Merkmale

Bohrungsdurchmesser Toleranz IT5/IT6:

- Durchmesser in Abstufungen von 0,001 mm frei wählbar
- Abhängig vom Durchmesserbereich ab Toleranz IT5/IT6 bestellbar
- > Ø30,000 IT5 | ≤ Ø30,000 IT6

Spezifikation:

HPR200Ø[Durchmesser][Toleranz]MA0A-PU620

Bohrungsdurchmesser Toleranz < IT5/IT6:

- Toleranzen kleiner IT5/IT6 als spezieller Werkzeugdurchmesser bestellbar (G-Variante siehe Seite 373)

Spezifikation G-Variante:

HPR200GØ[Durchmesser][Toleranz]MA0A-PU620

Abmessungen konfigurierbare Baureihe IT5/IT6

d_1	l_4	l_5	HFS-Größe	z	Toleranz
18,600 - 20,390	25	-	12	6	IT6
20,400 - 21,290	27	-	12	6	IT6
21,300 - 23,990	27	-	14	6	IT6
24,000 - 29,990	35	-	16	6	IT6
30,000 - 39,990	41	-	20	8	IT5
40,000 - 65,000	47	-	24	8	IT5

Beispiel Toleranz IT5:

HPR200Ø35.350H5MA0A-PU620

Bohrungsdurchmesser $d_1 = 35,350 \text{ H5}$

Beispiel G-Variante:

HPR200GØ35.350+1-1MA0A-PU620

Spezieller Werkzeugdurchmesser $d_1 = 35,350 +1 \mu\text{m} -1 \mu\text{m}$

Maßangaben in mm.

Zugehörige HFS-Wechselkopfhalter ab Seite 460.

Schnittwertempfehlung siehe Kapitelende.

HPR-Wechselkopfreibahle

Feinjustierbare Ausführung, linksschräg genutet, für Durchgangsbohrung
HPR210

Ausführung:

Reibahldurchmesser: 18,600 - 65,000 mm
Anschnitt: ME1G
Schneidstoff: CU134
Cermet unbeschichtet

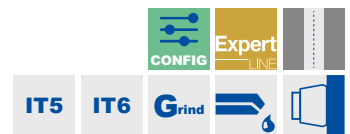
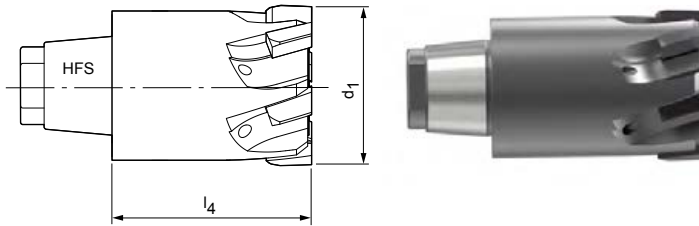

Konfigurierbare Merkmale

Bohrungsdurchmesser Toleranz IT5/IT6:

- Durchmesser in Abstufungen von 0,001 mm frei wählbar
- Abhängig vom Durchmesserbereich ab Toleranz IT5/IT6 bestellbar
- > 030,000 IT5 | ≤ 030,000 IT6

Spezifikation:

HPR210Ø[Durchmesser][Toleranz]ME1G-CU134

Bohrungsdurchmesser Toleranz < IT5/IT6:

- Toleranzen kleiner IT5/IT6 als spezieller Werkzeugdurchmesser bestellbar (G-Variante siehe Seite 373)

Spezifikation G-Variante:

HPR210GØ[Durchmesser][Toleranz]ME1G-CU134

Abmessungen konfigurierbare Baureihe IT5/IT6

d_1	l_4	l_5	HFS-Größe	z	Toleranz
18,600 - 20,390	25	-	12	6	IT6
20,400 - 21,290	27	-	12	6	IT6
21,300 - 23,990	27	-	14	6	IT6
24,000 - 29,990	35	-	16	6	IT6
30,000 - 39,990	41	-	20	8	IT5
40,000 - 65,000	47	-	24	8	IT5

Beispiel Toleranz IT5:

HPR210Ø35.350H5ME1G-CU134

Bohrungsdurchmesser $d_1 = 35,350 \text{ H5}$

Beispiel G-Variante:

HPR210GØ35.350+1-1ME1G-CU134

Spezieller Werkzeugdurchmesser $d_1 = 35,350 +1 \mu\text{m} -1 \mu\text{m}$

HPR-Wechselkopffreibahle

Feinjustierbare Ausführung, linksschräg genutet, für Durchgangsbohrung
HPR210

Ausführung:

Reibahlerdurchmesser: 18,600 - 65,000 mm
 Anschnitt: ME1G
 Schneidstoff: HP421
 Hartmetall
 PVD-beschichtet

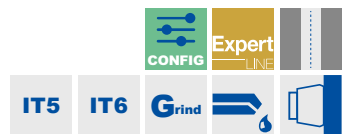
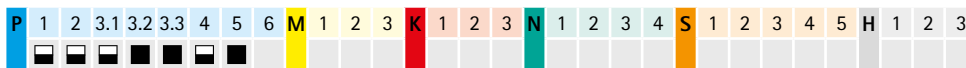
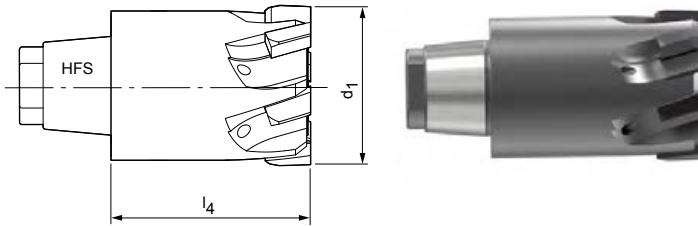

Konfigurierbare Merkmale

Bohrungsdurchmesser Toleranz IT5/IT6:

- Durchmesser in Abstufungen von 0,001 mm frei wählbar
- Abhängig vom Durchmesserbereich ab Toleranz IT5/IT6 bestellbar
- > Ø30,000 IT5 | ≤ Ø30,000 IT6

Spezifikation:

HPR210Ø[Durchmesser][Toleranz]ME1G-HP421

Bohrungsdurchmesser Toleranz < IT5/IT6:

- Toleranzen kleiner IT5/IT6 als spezieller Werkzeugdurchmesser bestellbar (G-Variante siehe Seite 373)

Spezifikation G-Variante:

HPR210GØ[Durchmesser][Toleranz]ME1G-HP421

Abmessungen konfigurierbare Baureihe IT5/IT6

d_1	l_4	l_5	HFS-Größe	z	Toleranz
18,600 - 20,390	25	-	12	6	IT6
20,400 - 21,290	27	-	12	6	IT6
21,300 - 23,990	27	-	14	6	IT6
24,000 - 29,990	35	-	16	6	IT6
30,000 - 39,990	41	-	20	8	IT5
40,000 - 65,000	47	-	24	8	IT5

Beispiel Toleranz IT5:

HPR210Ø35.350H5ME1G-HP421

Bohrungsdurchmesser $d_1 = 35,350 \text{ H5}$

Beispiel G-Variante:

HPR210GØ35.350+1-1ME1G-HP421

Spezieller Werkzeugdurchmesser $d_1 = 35,350 +1 \mu\text{m} -1 \mu\text{m}$

Maßangaben in mm.

Zugehörige HFS-Wechselkopfhalter ab Seite 460.

Schnittwertempfehlung siehe Kapitelende.

HPR-Wechselkopfreibahle

Feinjustierbare Ausführung, linksschräg genutet, für Durchgangsbohrung
HPR210

Ausführung:

Reibahldurchmesser: 18,600 - 65,000 mm
 Anschnitt: MF1G
 Schneidstoff: HP421
 Hartmetall
 PVD-beschichtet

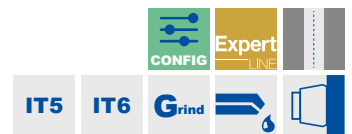
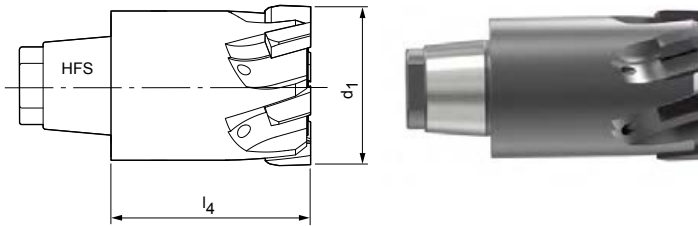

Konfigurierbare Merkmale



Bohrungsdurchmesser Toleranz IT5/IT6:

- Durchmesser in Abstufungen von 0,001 mm frei wählbar
- Abhängig vom Durchmesserbereich ab Toleranz IT5/IT6 bestellbar
- > Ø30,000 IT5 | ≤ Ø30,000 IT6

Spezifikation:

HPR210Ø[Durchmesser][Toleranz]MF1G-HP421

Bohrungsdurchmesser Toleranz < IT5/IT6:

- Toleranzen kleiner IT5/IT6 als spezieller Werkzeugdurchmesser bestellbar (G-Variante siehe Seite 373)

Spezifikation G-Variante:

HPR210GØ[Durchmesser][Toleranz]MF1G-HP421

Abmessungen konfigurierbare Baureihe IT5/IT6

d ₁	l ₄	l ₅	HFS-Größe	z	Toleranz
18,600 - 20,390	25	-	12	6	IT6
20,400 - 21,290	27	-	12	6	IT6
21,300 - 23,990	27	-	14	6	IT6
24,000 - 29,990	35	-	16	6	IT6
30,000 - 39,990	41	-	20	8	IT5
40,000 - 65,000	47	-	24	8	IT5

Beispiel Toleranz IT5:

HPR210Ø35.350H5MF1G-HP421

Bohrungsdurchmesser d₁ = 35,350 H5

Beispiel G-Variante:

HPR210GØ35.350+1-1MF1G-HP421

Spezieller Werkzeugdurchmesser d₁ = 35,350 +1 µm -1 µm

HPR-Wechselkopffreibahle

Feinjustierbare Ausführung, linksschräg genutet, für Durchgangsbohrung
HPR210

Ausführung:

Reibahldurchmesser: 18,600 - 65,000 mm
Anschnitt: MF1G
Schneidstoff: HP625
Hartmetall
PVD-beschichtet

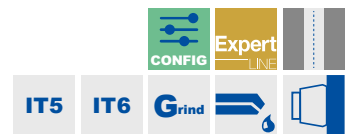
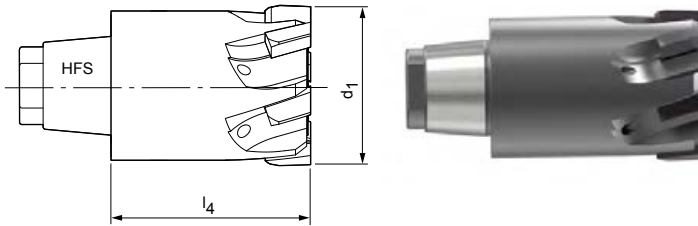

Konfigurierbare Merkmale



Bohrungsdurchmesser Toleranz IT5/IT6:

- Durchmesser in Abstufungen von 0,001 mm frei wählbar
- Abhängig vom Durchmesserbereich ab Toleranz IT5/IT6 bestellbar
- > 030,000 IT5 | ≤ 030,000 IT6

Spezifikation:

HPR210Ø[Durchmesser][Toleranz]MF1G-HP625

Bohrungsdurchmesser Toleranz < IT5/IT6:

- Toleranzen kleiner IT5/IT6 als spezieller Werkzeugdurchmesser bestellbar (G-Variante siehe Seite 373)

Spezifikation G-Variante:

HPR210GØ[Durchmesser][Toleranz]MF1G-HP625

Abmessungen konfigurierbare Baureihe IT5/IT6

d_1	l_4	l_5	HFS-Größe	z	Toleranz
18,600 - 20,390	25	-	12	6	IT6
20,400 - 21,290	27	-	12	6	IT6
21,300 - 23,990	27	-	14	6	IT6
24,000 - 29,990	35	-	16	6	IT6
30,000 - 39,990	41	-	20	8	IT5
40,000 - 65,000	47	-	24	8	IT5

Beispiel Toleranz IT5:

HPR210Ø35.350H5MF1G-HP625

Bohrungsdurchmesser $d_1 = 35,350 \text{ H5}$

Beispiel G-Variante:

HPR210GØ35.350+1-1MF1G-HP625

Spezieller Werkzeugdurchmesser $d_1 = 35,350 +1 \mu\text{m} -1 \mu\text{m}$

Maßangaben in mm.

Zugehörige HFS-Wechselkopfhalter ab Seite 460.
Schnittwertempfehlung siehe Kapitelende.

HPR-Wechselkopffreibahle

Feinjustierbare Ausführung, gerade genutet, für Grundbohrung
HPR280

Ausführung:

Reibahldurchmesser: 7,000 - 21,290 mm
Anschnitt: ML2G
Schneidstoff: CU134
Cermet unbeschichtet

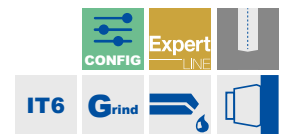
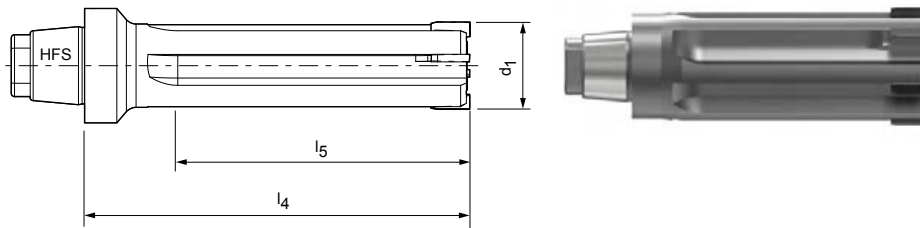

Konfigurierbare Merkmale



Bohrungsdurchmesser Toleranz IT6:

- Durchmesser in Abstufungen von 0,001 mm frei wählbar
- In Toleranz IT6 bestellbar

Spezifikation:

HPR280Ø[Durchmesser][Toleranz]ML2G-CU134

Bohrungsdurchmesser Toleranz < IT6:

- Toleranzen kleiner IT6 als spezieller Werkzeugdurchmesser bestellbar (G-Variante siehe Seite 373)

Spezifikation G-Variante:

HPR280GØ[Durchmesser][Toleranz]ML2G-CU134

Abmessungen konfigurierbare Baureihe IT6

d_1	l_4	l_5	HFS-Größe	z
7,000 - 14,590	60	40	12	4
14,600 - 21,290	60	40	12	6

Beispiel Toleranz IT6:

HPR280Ø16.350H6ML2G-CU134

Bohrungsdurchmesser $d_1 = 16,350 \text{ H6}$

Beispiel G-Variante:

HPR280GØ16.350+1-1ML2G-CU134

Spezieller Werkzeugdurchmesser $d_1 = 16,350 +1 \mu\text{m} -1 \mu\text{m}$

Maßangaben in mm.

Zugehörige HFS-Wechselkopfhalter ab Seite 460.

Schnittwertempfehlung siehe Kapitelende.

HPR-Wechselkopffreibahle

Feinjustierbare Ausführung, gerade genutet, für Grundbohrung
HPR280

Ausführung:

Reibahldurchmesser: 7,000 - 21,290 mm
 Anschnitt: ML2G
 Schneidstoff: HP421
 Hartmetall
 PVD-beschichtet

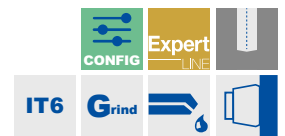
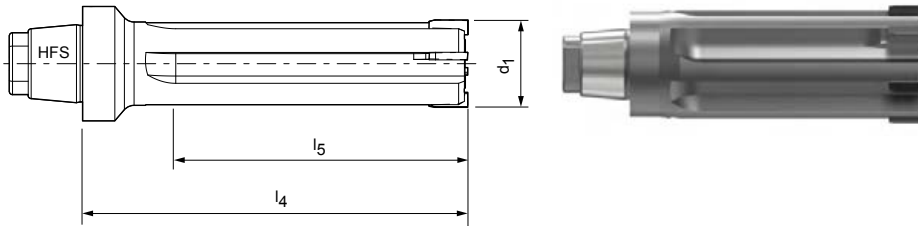

Konfigurierbare Merkmale



Bohrungsdurchmesser Toleranz IT6:

- Durchmesser in Abstufungen von 0,001 mm frei wählbar
- In Toleranz IT6 bestellbar

Spezifikation:

HPR280Ø[Durchmesser][Toleranz]ML2G-HP421

Bohrungsdurchmesser Toleranz < IT6:

- Toleranzen kleiner IT6 als spezieller Werkzeugdurchmesser bestellbar (G-Variante siehe Seite 373)

Spezifikation G-Variante:

HPR280GØ[Durchmesser][Toleranz]ML2G-HP421

Abmessungen konfigurierbare Baureihe IT6

d_1	l_4	l_5	HFS-Größe	z
7,000 - 14,590	60	40	12	4
14,600 - 21,290	60	40	12	6

Beispiel Toleranz IT6:

HPR280Ø16.350H6ML2G-HP421

Bohrungsdurchmesser $d_1 = 16,350 \text{ H6}$

Beispiel G-Variante:

HPR280GØ16.350+1-1ML2G-HP421

Spezieller Werkzeugdurchmesser $d_1 = 16,350 +1 \mu\text{m} -1 \mu\text{m}$

Maßangaben in mm.

Zugehörige HFS-Wechselkopfhalter ab Seite 460.

Schnittwertempfehlung siehe Kapitelende.

HPR-Wechselkopfreibahle

Feinjustierbare Ausführung, gerade genutet, für Grundbohrung
HPR280

Ausführung:

Reibahldurchmesser: 7,000 - 21,290 mm
 Anschnitt: M02G
 Schneidstoff: HP421
 Hartmetall
 PVD-beschichtet

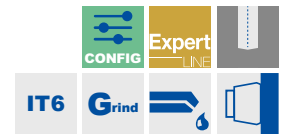
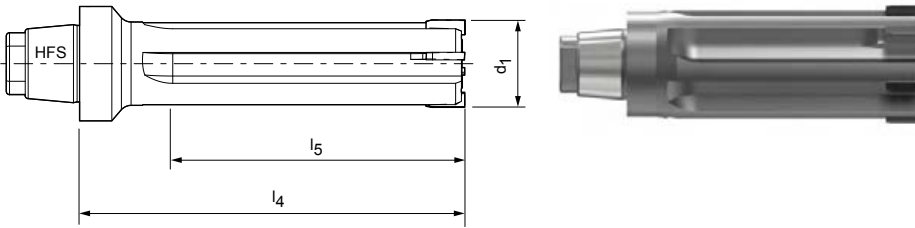

Konfigurierbare Merkmale



Bohrungsdurchmesser Toleranz IT6:

- Durchmesser in Abstufungen von 0,001 mm frei wählbar
- In Toleranz IT6 bestellbar

Spezifikation:

HPR280Ø[Durchmesser][Toleranz]M02G-HP421

Bohrungsdurchmesser Toleranz < IT6:

- Toleranzen kleiner IT6 als spezieller Werkzeugdurchmesser bestellbar (G-Variante siehe Seite 373)

Spezifikation G-Variante:

HPR280GØ[Durchmesser][Toleranz]M02G-HP421

Abmessungen konfigurierbare Baureihe IT6

d ₁	l ₄	l ₅	HFS-Größe	z
7,000 - 14,590	60	40	12	4
14,600 - 21,290	60	40	12	6

Beispiel Toleranz IT6:

HPR280Ø16.350H6M02G-HP421

Bohrungsdurchmesser d₁ = 16,350 H6

Beispiel G-Variante:

HPR280GØ16.350+1-1M02G-HP421

Spezieller Werkzeugdurchmesser d₁ = 16,350 +1 µm -1 µm

Maßangaben in mm.

Zugehörige HFS-Wechselkopfhalter ab Seite 460.

Schnittwertempfehlung siehe Kapitelende.

HPR-Wechselkopfreibahle

Feinjustierbare Ausführung, gerade genutet, für Grundbohrung
HPR280

Ausführung:

Reibahlundurchmesser: 7,000 - 21,290 mm
Anschnitt: MC1G
Schneidstoff: CP134
Cermet
PVD-beschichtet

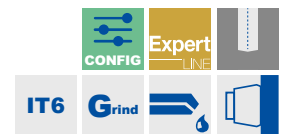
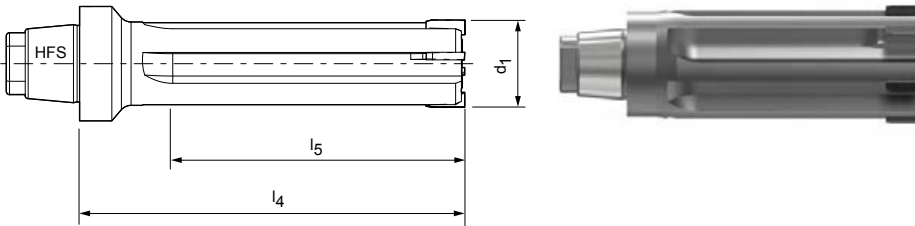

Konfigurierbare Merkmale



Bohrungsdurchmesser Toleranz IT6:

- Durchmesser in Abstufungen von 0,001 mm frei wählbar
- In Toleranz IT6 bestellbar

Spezifikation:

HPR280Ø[Durchmesser][Toleranz]MC1G-CP134

Bohrungsdurchmesser Toleranz < IT6:

- Toleranzen kleiner IT6 als spezieller Werkzeugdurchmesser bestellbar (G-Variante siehe Seite 373)

Spezifikation G-Variante:

HPR280GØ[Durchmesser][Toleranz]MC1G-CP134

Abmessungen konfigurierbare Baureihe IT6

d_1	l_4	l_5	HFS-Größe	z
7,000 - 14,590	60	40	12	4
14,600 - 21,290	60	40	12	6

Beispiel Toleranz IT6:

HPR280Ø16.350H6MC1G-CP134

Bohrungsdurchmesser $d_1 = 16,350 \text{ H6}$

Beispiel G-Variante:

HPR280GØ16.350+1-1MC1G-CP134

Spezieller Werkzeugdurchmesser $d_1 = 16,350 + 1 \mu\text{m} - 1 \mu\text{m}$

Maßangaben in mm.

* für Oberflächen $R_a < 2 \mu\text{m}$

Zugehörige HFS-Wechselkopfhalter ab Seite 460.

Schnittwertempfehlung siehe Kapitelende.

HPR-Wechselkopffreibahle

Feinjustierbare Ausführung, gerade genutet, für Grundbohrung
HPR280

Ausführung:

Reibahldurchmesser: 7,000 - 21,290 mm
 Anschnitt: MC1G
 Schneidstoff: HP421
 Hartmetall
 PVD-beschichtet

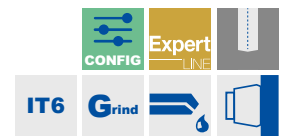
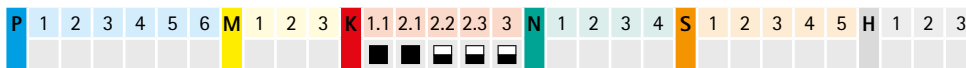
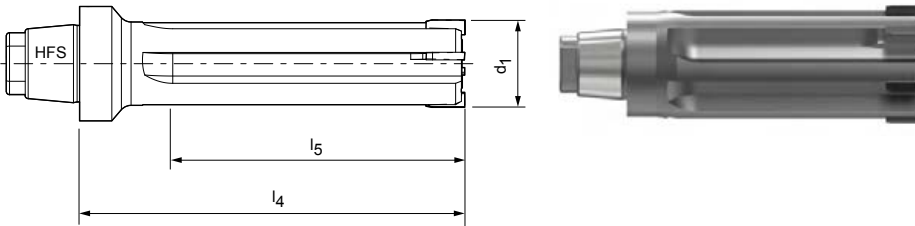

Konfigurierbare Merkmale



Bohrungsdurchmesser Toleranz IT6:

- Durchmesser in Abstufungen von 0,001 mm frei wählbar
- In Toleranz IT6 bestellbar

Spezifikation:

HPR280Ø[Durchmesser][Toleranz]MC1G-HP421

Bohrungsdurchmesser Toleranz < IT6:

- Toleranzen kleiner IT6 als spezieller Werkzeugdurchmesser bestellbar (G-Variante siehe Seite 373)

Spezifikation G-Variante:

HPR280GØ[Durchmesser][Toleranz]MC1G-HP421

Abmessungen konfigurierbare Baureihe IT6

d ₁	l ₄	l ₅	HFS-Größe	z
7,000 - 14,590	60	40	12	4
14,600 - 21,290	60	40	12	6

Beispiel Toleranz IT6:

HPR280Ø16.350H6MC1G-HP421

Bohrungsdurchmesser d₁ = 16,350 H6

Beispiel G-Variante:

HPR280GØ16.350+1-1MC1G-HP421

Spezieller Werkzeugdurchmesser d₁ = 16,350 +1 µm -1 µm

Maßangaben in mm.

Zugehörige HFS-Wechselkopfhalter ab Seite 460.

Schnittwertempfehlung siehe Kapitelende.

HPR-Wechselkopffreibahle

Feinjustierbare Ausführung, gerade genutet, für Grundbohrung
HPR280

Ausführung:

Reibahldurchmesser: 7,000 - 21,290 mm
Anschnitt: MC1G
Schneidstoff: HP423
Hartmetall
PVD-beschichtet

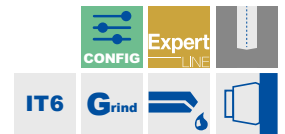
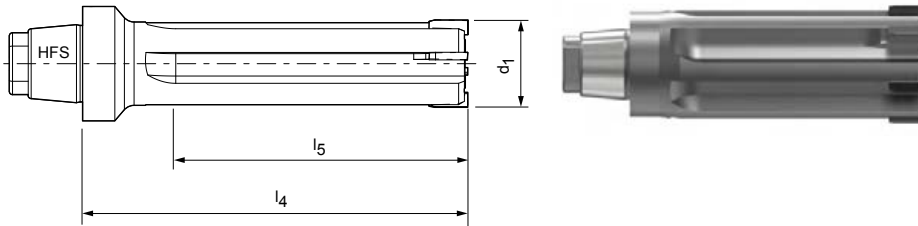

Konfigurierbare Merkmale



Bohrungsdurchmesser Toleranz IT6:

- Durchmesser in Abstufungen von 0,001 mm frei wählbar
- In Toleranz IT6 bestellbar

Spezifikation:

HPR280Ø[Durchmesser][Toleranz]MC1G-HP423

Bohrungsdurchmesser Toleranz < IT6:

- Toleranzen kleiner IT6 als spezieller Werkzeugdurchmesser bestellbar (G-Variante siehe Seite 373)

Spezifikation G-Variante:

HPR280GØ[Durchmesser][Toleranz]MC1G-HP423

Abmessungen konfigurierbare Baureihe IT6

d_1	l_4	l_5	HFS-Größe	z
7,000 - 14,590	60	40	12	4
14,600 - 21,290	60	40	12	6

Beispiel Toleranz IT6:

HPR280Ø16.350H6MC1G-HP423

Bohrungsdurchmesser $d_1 = 16,350 \text{ H6}$

Beispiel G-Variante:

HPR280GØ16.350+1-1MC1G-HP423

Spezieller Werkzeugdurchmesser $d_1 = 16,350 + 1 \mu\text{m} - 1 \mu\text{m}$

Maßangaben in mm.

Zugehörige HFS-Wechselkopfhalter ab Seite 460.

Schnittwertempfehlung siehe Kapitelende.

HPR-Wechselkopfreibahle

Feinjustierbare Ausführung, gerade genutet, für Grundbohrung
HPR280

Ausführung:

Reibahlundurchmesser: 7,000 - 21,290 mm
 Anschnitt: MA0A
 Schneidstoff: PU620
 PKD-bestückt

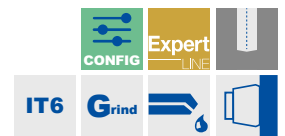
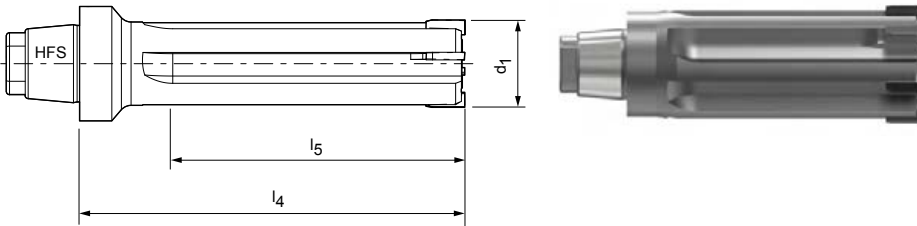

Konfigurierbare Merkmale



Bohrungsdurchmesser Toleranz IT6:

- Durchmesser in Abstufungen von 0,001 mm frei wählbar
- In Toleranz IT6 bestellbar

Spezifikation:

HPR280Ø[Durchmesser][Toleranz]MA0A-PU620

Bohrungsdurchmesser Toleranz < IT6:

- Toleranzen kleiner IT6 als spezieller Werkzeugdurchmesser bestellbar (G-Variante siehe Seite 373)

Spezifikation G-Variante:

HPR280GØ[Durchmesser][Toleranz]MA0A-PU620

Abmessungen konfigurierbare Baureihe IT6

d ₁	l ₄	l ₅	HFS-Größe	z
7,000 - 14,590	60	40	12	4
14,600 - 21,290	60	40	12	6

Beispiel Toleranz IT6:

HPR280Ø16.350H6MA0A-PU620

Bohrungsdurchmesser d₁ = 16,350 H6

Beispiel G-Variante:

HPR280GØ16.350+1-1MA0A-PU620

Spezieller Werkzeugdurchmesser d₁ = 16,350 +1 µm -1 µm

Maßangaben in mm.

Zugehörige HFS-Wechselkopfhalter ab Seite 460.

Schnittwertempfehlung siehe Kapitelende.

HPR-Wechselkopffreibahle

Feinjustierbare Ausführung, gerade genutet, für Grundbohrung
HPR280

Ausführung:

Reibahldurchmesser: 7,000 - 21,290 mm
Anschnitt: M02G
Schneidstoff: HP625
Hartmetall
PVD-beschichtet

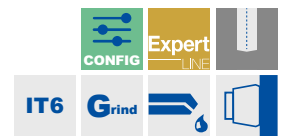
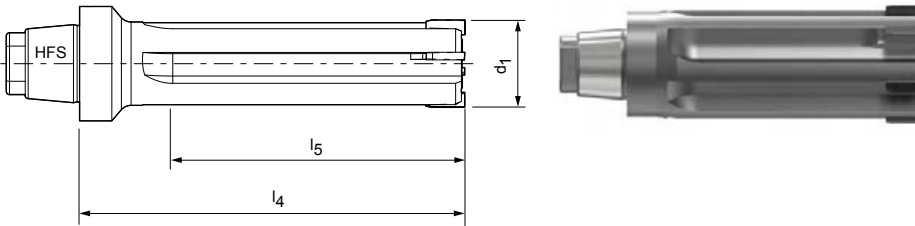

Konfigurierbare Merkmale



Bohrungsdurchmesser Toleranz IT6:

- Durchmesser in Abstufungen von 0,001 mm frei wählbar
- In Toleranz IT6 bestellbar

Spezifikation:

HPR280Ø[Durchmesser][Toleranz]M02G-HP625

Bohrungsdurchmesser Toleranz < IT6:

- Toleranzen kleiner IT6 als spezieller Werkzeugdurchmesser bestellbar (G-Variante siehe Seite 373)

Spezifikation G-Variante:

HPR280GØ[Durchmesser][Toleranz]M02G-HP625

Abmessungen konfigurierbare Baureihe IT6

d_1	l_4	l_5	HFS-Größe	z
7,000 - 14,590	60	40	12	4
14,600 - 21,290	60	40	12	6

Beispiel Toleranz IT6:

HPR280Ø16.350H6M02G-HP625

Bohrungsdurchmesser $d_1 = 16,350 \text{ H6}$

Beispiel G-Variante:

HPR280GØ16.350+1-1M02G-HP625

Spezieller Werkzeugdurchmesser $d_1 = 16,350 +1 \mu\text{m} -1 \mu\text{m}$

Maßangaben in mm.

Zugehörige HFS-Wechselkopfhalter ab Seite 460.

Schnittwertempfehlung siehe Kapitelende.

HPR-Wechselkopfreibahle

Feinjustierbare Ausführung, gerade genutet, für Grundbohrung
HPR250

Ausführung:

Reibahlundurchmesser: 16,600 - 65,000 mm
 Anschnitt: ML2G
 Schneidstoff: CU134
 Cermet unbeschichtet

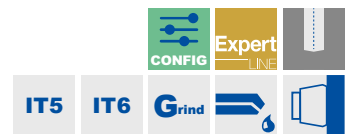
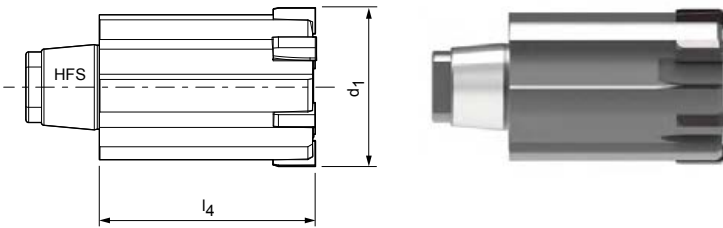

Konfigurierbare Merkmale

Bohrungsdurchmesser Toleranz IT5/IT6:

- Durchmesser in Abstufungen von 0,001 mm frei wählbar
- Abhängig vom Durchmesserbereich ab Toleranz IT5/IT6 bestellbar
- > Ø30,000 IT5 | ≤ Ø30,000 IT6

Spezifikation:
HPR250Ø[Durchmesser][Toleranz]ML2G-CU134

Bohrungsdurchmesser Toleranz < IT5/IT6:

- Toleranzen kleiner IT5/IT6 als spezieller Werkzeugdurchmesser bestellbar (G-Variante siehe Seite 373)

Spezifikation G-Variante:
HPR250GØ[Durchmesser][Toleranz]ML2G-CU134

Abmessungen konfigurierbare Baureihe IT5/IT6

d ₁	l ₄	l ₅	HFS-Größe	z	Toleranz
16,600 - 21,290	25	-	10	6	IT6
21,300 - 24,990	27	-	12	6	IT6
25,000 - 28,590	35	-	14	6	IT6
29,000 - 32,290	35	-	16	6	IT5
32,300 - 36,990	41	-	16	6	IT5
37,000 - 41,190	41	-	20	8	IT5
41,200 - 44,900	47	-	20	8	IT5
45,000 - 65,000	47	-	24	8	IT5

Beispiel Toleranz IT5:
HPR250Ø35.350H5ML2G-CU134

Bohrungsdurchmesser d₁ = 35,350 H5

Beispiel G-Variante:
HPR250GØ35.350+1-1ML2G-CU134

Spezieller Werkzeugdurchmesser d₁ = 35,350 +1 µm -1 µm

Maßangaben in mm.
 Zugehörige HFS-Wechselkopfhalter ab Seite 460.
 Schnittwertempfehlung siehe Kapitelende.

HPR-Wechselkopfreibahle

Feinjustierbare Ausführung, gerade genutet, für Grundbohrung
HPR250

Ausführung:

Reibahldurchmesser: 16,600 - 65,000 mm
Anschnitt: ML2G
Schneidstoff: HP421
Hartmetall
PVD-beschichtet

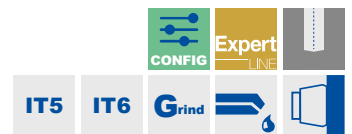
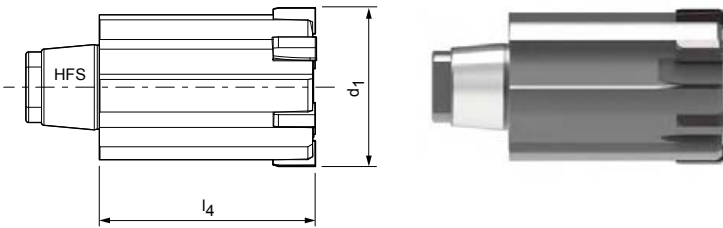

Konfigurierbare Merkmale



Bohrungsdurchmesser Toleranz IT5/IT6:

- Durchmesser in Abstufungen von 0,001 mm frei wählbar
- Abhängig vom Durchmesserbereich ab Toleranz IT5/IT6 bestellbar
- > Ø30,000 IT5 | ≤ Ø30,000 IT6

Spezifikation:

HPR250Ø[Durchmesser][Toleranz]ML2G-HP421

Bohrungsdurchmesser Toleranz < IT5/IT6:

- Toleranzen kleiner IT5/IT6 als spezieller Werkzeugdurchmesser bestellbar (G-Variante siehe Seite 373)

Spezifikation G-Variante:

HPR250GØ[Durchmesser][Toleranz]ML2G-HP421

Abmessungen konfigurierbare Baureihe IT5/IT6

d_1	l_4	l_5	HFS-Größe	z	Toleranz
16,600 - 21,290	25	-	10	6	IT6
21,300 - 24,990	27	-	12	6	IT6
25,000 - 28,590	35	-	14	6	IT6
29,000 - 32,290	35	-	16	6	IT5
32,300 - 36,990	41	-	16	6	IT5
37,000 - 41,190	41	-	20	8	IT5
41,200 - 44,900	47	-	20	8	IT5
45,000 - 65,000	47	-	24	8	IT5

Beispiel Toleranz IT5:

HPR250Ø35.350H5ML2G-HP421

Bohrungsdurchmesser $d_1 = 35,350 \text{ H5}$

Beispiel G-Variante:

HPR250GØ35.350+1-1ML2G-HP421

Spezieller Werkzeugdurchmesser $d_1 = 35,350 +1 \mu\text{m} -1 \mu\text{m}$

Maßangaben in mm.

Zugehörige HFS-Wechselkopfhalter ab Seite 460.

Schnittwertempfehlung siehe Kapitelende.

HPR-Wechselkopfreibahle

Feinjustierbare Ausführung, gerade genutet, für Grundbohrung
HPR250

Ausführung:

Reibahldurchmesser: 16,600 - 65,000 mm
 Anschnitt: M02G
 Schneidstoff: HP421
 Hartmetall
 PVD-beschichtet

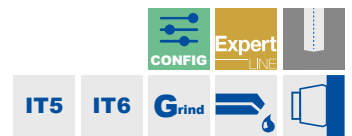
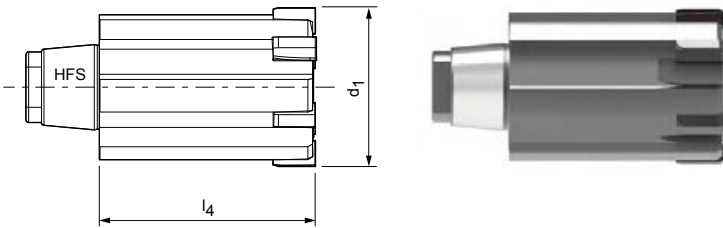

Konfigurierbare Merkmale



Bohrungsdurchmesser Toleranz IT5/IT6:

- Durchmesser in Abstufungen von 0,001 mm frei wählbar
- Abhängig vom Durchmesserbereich ab Toleranz IT5/IT6 bestellbar
- > Ø30,000 IT5 | ≤ Ø30,000 IT6

Spezifikation:

HPR250Ø[Durchmesser][Toleranz]M02G-HP421

Bohrungsdurchmesser Toleranz < IT5/IT6:

- Toleranzen kleiner IT5/IT6 als spezieller Werkzeugdurchmesser bestellbar (G-Variante siehe Seite 373)

Spezifikation G-Variante:

HPR250GØ[Durchmesser][Toleranz]M02G-HP421

Abmessungen konfigurierbare Baureihe IT5/IT6

d ₁	l ₄	l ₅	HFS-Größe	z	Toleranz
16,600 - 21,290	25	-	10	6	IT6
21,300 - 24,990	27	-	12	6	IT6
25,000 - 28,590	35	-	14	6	IT6
29,000 - 32,290	35	-	16	6	IT5
32,300 - 36,990	41	-	16	6	IT5
37,000 - 41,190	41	-	20	8	IT5
41,200 - 44,900	47	-	20	8	IT5
45,000 - 65,000	47	-	24	8	IT5

Beispiel Toleranz IT5:

HPR250Ø35.350H5M02G-HP421

Bohrungsdurchmesser d₁ = 35,350 H5

Beispiel G-Variante:

HPR250GØ35.350+1-1M02G-HP421

Spezieller Werkzeugdurchmesser d₁ = 35,350 +1 µm -1 µm

Maßangaben in mm.

Zugehörige HFS-Wechselkopfhalter ab Seite 460.

Schnittwertempfehlung siehe Kapitelende.

HPR-Wechselkopfreibahle

Feinjustierbare Ausführung, gerade genutet, für Grundbohrung
HPR250

Ausführung:

Reibahldurchmesser: 16,600 - 65,000 mm
Anschnitt: MC1G
Schneidstoff: CP134
Cermet
PVD-beschichtet

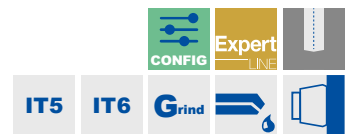
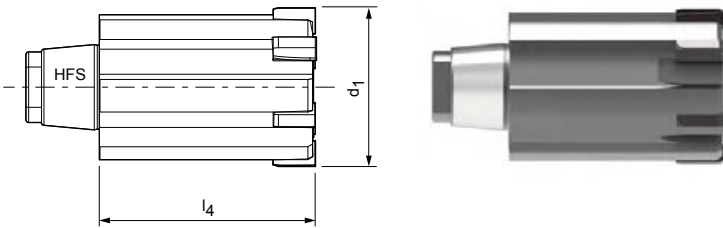

Konfigurierbare Merkmale



Bohrungsdurchmesser Toleranz IT5/IT6:

- Durchmesser in Abstufungen von 0,001 mm frei wählbar
- Abhängig vom Durchmesserbereich ab Toleranz IT5/IT6 bestellbar
- > Ø30,000 IT5 | ≤ Ø30,000 IT6

Spezifikation:

HPR250Ø[Durchmesser][Toleranz]MC1G-CP134

Bohrungsdurchmesser Toleranz < IT5/IT6:

- Toleranzen kleiner IT5/IT6 als spezieller Werkzeugdurchmesser bestellbar (G-Variante siehe Seite 373)

Spezifikation G-Variante:

HPR250GØ[Durchmesser][Toleranz]MC1G-CP134

Abmessungen konfigurierbare Baureihe IT5/IT6

d_1	l_4	l_5	HFS-Größe	z	Toleranz
16,600 - 21,290	25	-	10	6	IT6
21,300 - 24,990	27	-	12	6	IT6
25,000 - 28,590	35	-	14	6	IT6
29,000 - 32,290	35	-	16	6	IT5
32,300 - 36,990	41	-	16	6	IT5
37,000 - 41,190	41	-	20	8	IT5
41,200 - 44,900	47	-	20	8	IT5
45,000 - 65,000	47	-	24	8	IT5

Beispiel Toleranz IT5:

HPR250Ø35.350H5MC1G-CP134

Bohrungsdurchmesser $d_1 = 35,350 \text{ H5}$

Beispiel G-Variante:

HPR250GØ35.350+1-1MC1G-CP134

Spezieller Werkzeugdurchmesser $d_1 = 35,350 +1 \mu\text{m} -1 \mu\text{m}$

Maßangaben in mm.

* für Oberflächen $R_a < 2 \mu\text{m}$

Zugehörige HFS-Wechselkopfhalter ab Seite 460.

Schnittwertempfehlung siehe Kapitelende.

HPR-Wechselkopfreibahle

Feinjustierbare Ausführung, gerade genutet, für Grundbohrung
HPR250

Ausführung:

Reibahldurchmesser: 16,600 - 65,000 mm
 Anschnitt: MC1G
 Schneidstoff: HP421
 Hartmetall
 PVD-beschichtet

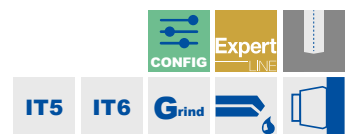
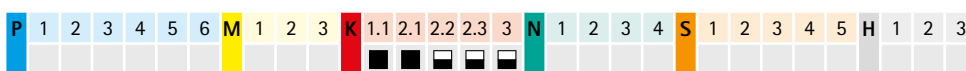
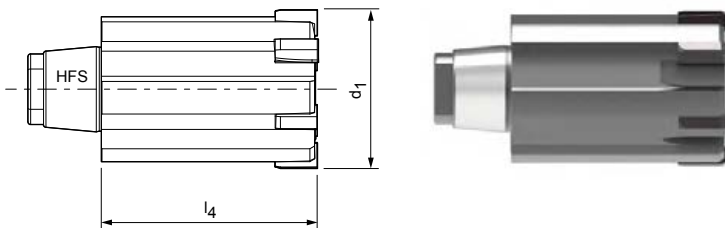

Konfigurierbare Merkmale

Bohrungsdurchmesser Toleranz IT5/IT6:

- Durchmesser in Abstufungen von 0,001 mm frei wählbar
- Abhängig vom Durchmesserbereich ab Toleranz IT5/IT6 bestellbar
- > Ø30,000 IT5 | ≤ Ø30,000 IT6

Spezifikation:
HPR250Ø[Durchmesser][Toleranz]MC1G-HP421

Bohrungsdurchmesser Toleranz < IT5/IT6:

- Toleranzen kleiner IT5/IT6 als spezieller Werkzeugdurchmesser bestellbar
- (G-Variante siehe Seite 373)

Spezifikation G-Variante:
HPR250GØ[Durchmesser][Toleranz]MC1G-HP421

Abmessungen konfigurierbare Baureihe IT5/IT6

d ₁	l ₄	l ₅	HFS-Größe	z	Toleranz
16,600 - 21,290	25	-	10	6	IT6
21,300 - 24,990	27	-	12	6	IT6
25,000 - 28,590	35	-	14	6	IT6
29,000 - 32,290	35	-	16	6	IT5
32,300 - 36,990	41	-	16	6	IT5
37,000 - 41,190	41	-	20	8	IT5
41,200 - 44,900	47	-	20	8	IT5
45,000 - 65,000	47	-	24	8	IT5

Beispiel Toleranz IT5:
HPR250Ø35.350H5MC1G-HP421

Bohrungsdurchmesser d₁ = 35,350 H5

Beispiel G-Variante:
HPR250GØ35.350+1-1MC1G-HP421

Spezieller Werkzeugdurchmesser d₁ = 35,350 +1 µm -1 µm

Maßangaben in mm.
 Zugehörige HFS-Wechselkopfhalter ab Seite 460.
 Schnittwertempfehlung siehe Kapitelende.

HPR-Wechselkopfreibahle

Feinjustierbare Ausführung, gerade genutet, für Grundbohrung
HPR250

Ausführung:

Reibahldurchmesser: 16,600 – 65,000 mm
Anschnitt: MC1G
Schneidstoff: HP423
Hartmetall
PVD-beschichtet

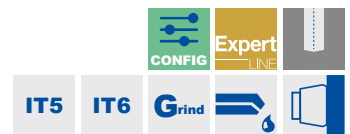
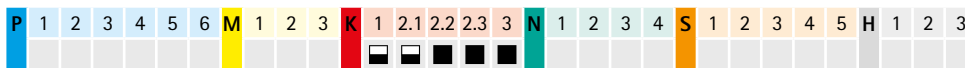
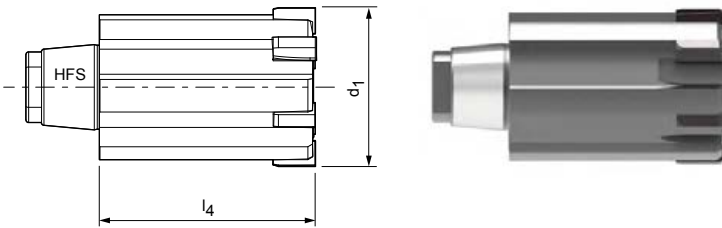

Konfigurierbare Merkmale



Bohrungsdurchmesser Toleranz IT5/IT6:

- Durchmesser in Abstufungen von 0,001 mm frei wählbar
- Abhängig vom Durchmesserbereich ab Toleranz IT5/IT6 bestellbar
- > Ø30,000 IT5 | ≤ Ø30,000 IT6

Spezifikation:

HPR250Ø[Durchmesser][Toleranz]MC1G-HP423

Bohrungsdurchmesser Toleranz < IT5/IT6:

- Toleranzen kleiner IT5/IT6 als spezieller Werkzeugdurchmesser bestellbar (G-Variante siehe Seite 373)

Spezifikation G-Variante:

HPR250GØ[Durchmesser][Toleranz]MC1G-HP423

Abmessungen konfigurierbare Baureihe IT5/IT6

d_1	l_4	l_5	HFS-Größe	z	Toleranz
16,600 – 21,290	25	–	10	6	IT6
21,300 – 24,990	27	–	12	6	IT6
25,000 – 28,590	35	–	14	6	IT6
29,000 – 32,290	35	–	16	6	IT5
32,300 – 36,990	41	–	16	6	IT5
37,000 – 41,190	41	–	20	8	IT5
41,200 – 44,900	47	–	20	8	IT5
45,000 – 65,000	47	–	24	8	IT5

Beispiel Toleranz IT5:

HPR250Ø35.350H5MC1G-HP423

Bohrungsdurchmesser $d_1 = 35,350 \text{ H5}$

Beispiel G-Variante:

HPR250GØ35.350+1-1MC1G-HP423

Spezieller Werkzeugdurchmesser $d_1 = 35,350 +1 \mu\text{m} -1 \mu\text{m}$

Maßangaben in mm.

Zugehörige HFS-Wechselkopfhalter ab Seite 460.

Schnittwertempfehlung siehe Kapitelende.

HPR-Wechselkopfreibahle

Feinjustierbare Ausführung, gerade genutet, für Grundbohrung
HPR250

Ausführung:

Reibahldurchmesser: 16,600 - 65,000 mm
 Anschnitt: MA0A
 Schneidstoff: PU620
 PKD-bestückt

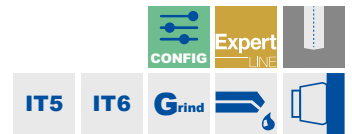
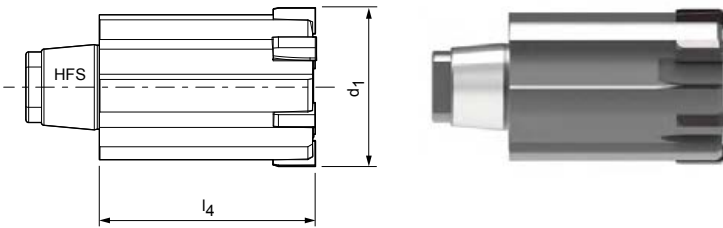

Konfigurierbare Merkmale



Bohrungsdurchmesser Toleranz IT5/IT6:

- Durchmesser in Abstufungen von 0,001 mm frei wählbar
- Abhängig vom Durchmesserbereich ab Toleranz IT5/IT6 bestellbar
- > Ø30,000 IT5 | ≤ Ø30,000 IT6

Spezifikation:

HPR250Ø[Durchmesser][Toleranz]MA0A-PU620

Bohrungsdurchmesser Toleranz < IT5/IT6:

- Toleranzen kleiner IT5/IT6 als spezieller Werkzeugdurchmesser bestellbar (G-Variante siehe Seite 373)

Spezifikation G-Variante:

HPR250GØ[Durchmesser][Toleranz]MA0A-PU620

Abmessungen konfigurierbare Baureihe IT5/IT6

d ₁	l ₄	l ₅	HFS-Größe	z	Toleranz
16,600 - 21,290	25	-	10	6	IT6
21,300 - 24,990	27	-	12	6	IT6
25,000 - 28,590	35	-	14	6	IT6
29,000 - 32,290	35	-	16	6	IT5
32,300 - 36,990	41	-	16	6	IT5
37,000 - 41,190	41	-	20	8	IT5
41,200 - 44,900	47	-	20	8	IT5
45,000 - 65,000	47	-	24	8	IT5

Beispiel Toleranz IT5:

HPR250Ø35.350H5MA0A-PU620

Bohrungsdurchmesser d₁ = 35,350 H5

Beispiel G-Variante:

HPR250GØ35.350+1-1MA0A-PU620

Spezieller Werkzeugdurchmesser d₁ = 35,350 +1 µm -1 µm

Maßangaben in mm.

Zugehörige HFS-Wechselkopfhalter ab Seite 460.

Schnittwertempfehlung siehe Kapitelende.

HPR-Wechselkopfreibahle

Feinjustierbare Ausführung, gerade genutet, für Grundbohrung
HPR250

Ausführung:

Reibahldurchmesser: 16,600 – 65,000 mm
Anschnitt: M02G
Schneidstoff: HP625
Hartmetall
PVD-beschichtet

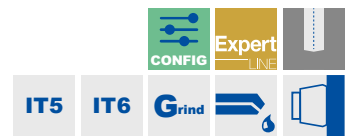
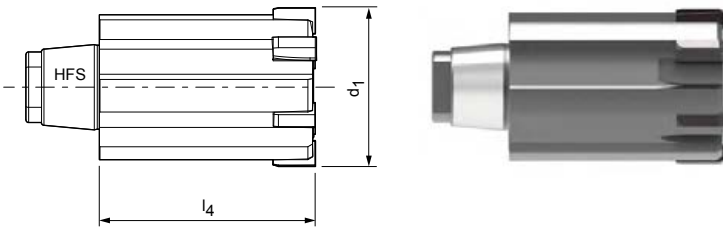

Konfigurierbare Merkmale



Bohrungsdurchmesser Toleranz IT5/IT6:

- Durchmesser in Abstufungen von 0,001 mm frei wählbar
- Abhängig vom Durchmesserbereich ab Toleranz IT5/IT6 bestellbar
- > Ø30,000 IT5 | ≤ Ø30,000 IT6

Spezifikation:

HPR250Ø[Durchmesser][Toleranz]M02G-HP625

Bohrungsdurchmesser Toleranz < IT5/IT6:

- Toleranzen kleiner IT5/IT6 als spezieller Werkzeugdurchmesser bestellbar (G-Variante siehe Seite 373)

Spezifikation G-Variante:

HPR250GØ[Durchmesser][Toleranz]M02G-HP625

Abmessungen konfigurierbare Baureihe IT5/IT6

d_1	l_4	l_5	HFS-Größe	z	Toleranz
16,600 – 21,290	25	–	10	6	IT6
21,300 – 24,990	27	–	12	6	IT6
25,000 – 28,590	35	–	14	6	IT6
29,000 – 32,290	35	–	16	6	IT5
32,300 – 36,990	41	–	16	6	IT5
37,000 – 41,190	41	–	20	8	IT5
41,200 – 44,900	47	–	20	8	IT5
45,000 – 65,000	47	–	24	8	IT5

Beispiel Toleranz IT5:

HPR250Ø35.350H5M02G-HP625

Bohrungsdurchmesser $d_1 = 35,350 \text{ H5}$

Beispiel G-Variante:

HPR250GØ35.350+1-1M02G-HP625

Spezieller Werkzeugdurchmesser $d_1 = 35,350 +1 \mu\text{m} -1 \mu\text{m}$

Maßangaben in mm.

Zugehörige HFS-Wechselkopfhalter ab Seite 460.

Schnittwertempfehlung siehe Kapitelende.

Schnittwertempfehlung für Wechselkopfreibahnen HPR

Vorschub und Schnittgeschwindigkeit

HPR131 | HPR231 | HPR180 | HPR280

Schneidstoff: HP421 | Anschnitt: ME1G | ML2G

MZG*		Werkstoff	Festigkeit/Härte [N/mm ²] [HRC]	Schnittgeschwindigkeit v _c (m/min)			Vorschub f _z (mm/u) bei Werkzeugdurchmesser	
				Innen- kühlung	Außen- kühlung	MMS	z 4	z 6
							7,000 - 9,590	9,600 - 21,290
P	P3.1	Werkzeug-, Wälzlager-, Feder- und Schnellarbeitsstähle**	< 800					
	P3.2	Werkzeug-, Wälzlager-, Feder- und Schnellarbeitsstähle**	< 1000	100	100	120	0,100	0,200
	P3.3	Werkzeug-, Wälzlager-, Feder- und Schnellarbeitsstähle**	< 1500	100	100	120	0,100	0,200
	P5.1	Stahlguss		35	35	35	0,070	0,070

HPR150 | HPR250

Schneidstoff: CU134 | Anschnitt: ML2G

MZG*		Werkstoff	Festigkeit/Härte [N/mm ²] [HRC]	Schnittgeschwindigkeit v _c (m/min)			Vorschub f _z (mm/u) bei Werkzeugdurchmesser	
				Innen- kühlung	Außen- kühlung	MMS	z 6	z 8
							16,600 - 36,990	37,000 - 65,000
P1	P1.1	Bau-, Automaten-, Einsatz- und Vergütungsstähle, unlegiert	< 700	140	100	120	0,200	0,250
	P1.2	Bau-, Automaten-, Einsatz- und Vergütungsstähle, unlegiert	< 1200	140	100	120	0,200	0,250
P2	P2.1	Nitrier-, Einsatz- und Vergütungsstähle, legiert	< 900	140	100	120	0,200	0,250
	P2.2	Nitrier-, Einsatz- und Vergütungsstähle, legiert	< 1400	140	100	120	0,200	0,250
P3	P3.1	Werkzeug-, Wälzlager-, Feder- und Schnellarbeitsstähle**	< 800	140	100	120	0,200	0,250
	P3.2	Werkzeug-, Wälzlager-, Feder- und Schnellarbeitsstähle**	< 1000					
	P3.3	Werkzeug-, Wälzlager-, Feder- und Schnellarbeitsstähle**	< 1500					

HPR180 | HPR280

Schneidstoff: CU134 | Anschnitt: ML2G

MZG*		Werkstoff	Festigkeit/Härte [N/mm ²] [HRC]	Schnittgeschwindigkeit v _c (m/min)			Vorschub f _z (mm/u) bei Werkzeugdurchmesser	
				Innen- kühlung	Außen- kühlung	MMS	z 4	z 6
							7,000 - 14,590	14,600 - 21,290
P1	P1.1	Bau-, Automaten-, Einsatz- und Vergütungsstähle, unlegiert	< 700	140	100	120	0,150	0,200
	P1.2	Bau-, Automaten-, Einsatz- und Vergütungsstähle, unlegiert	< 1200	140	100	120	0,150	0,200
P2	P2.1	Nitrier-, Einsatz- und Vergütungsstähle, legiert	< 900	140	100	120	0,150	0,200
	P2.2	Nitrier-, Einsatz- und Vergütungsstähle, legiert	< 1400	140	100	120	0,150	0,200
P3	P3.1	Werkzeug-, Wälzlager-, Feder- und Schnellarbeitsstähle**	< 800	140	100	120	0,150	0,200
	P3.2	Werkzeug-, Wälzlager-, Feder- und Schnellarbeitsstähle**	< 1000					
	P3.3	Werkzeug-, Wälzlager-, Feder- und Schnellarbeitsstähle**	< 1500					

* MAPAL Zerspanungsgruppen

** Wenn die Legierungsbestandteile Cr, Mo, Ni, V, W in Summe > 8 %, dann die nächst höhere MAPAL Zerspanungsgruppe wählen.

HPR110 | HPR210 | HPR150 | HPR250

Schneidstoff: HP421 | Anschnitt: ME1G | ML2G

MZG*	Werkstoff	Festigkeit/Härte [N/mm ²] [HRC]	Schnittgeschwindigkeit v _c (m/min)			Vorschub f _z (mm/u) bei Werkzeugdurchmesser		
			Innen- kühlung	Außen- kühlung	MMS	z 6	z 8	
						15,600 - 29,990	30,00 - 65,00	
P	P3.1	Werkzeug-, Wälzlager-, Feder- und Schnellarbeitsstähle**	< 800	120	100	120	0,200	0,200
	P3.2	Werkzeug-, Wälzlager-, Feder- und Schnellarbeitsstähle**	< 1000	100	100	120	0,200	0,200
	P3.3	Werkzeug-, Wälzlager-, Feder- und Schnellarbeitsstähle**	< 1500	100	100	120	0,200	0,200
	P5.1	Stahlguss		35	35	35	0,070	0,070

HPR110 | HPR210

Schneidstoff: CU134 | Anschnitt: ME1G

MZG*	Werkstoff	Festigkeit/Härte [N/mm ²] [HRC]	Schnittgeschwindigkeit v _c (m/min)			Vorschub f _z (mm/u) bei Werkzeugdurchmesser		
			Innen- kühlung	Außen- kühlung	MMS	z 6	z 8	
						15,600 - 29,990	30,000 - 65,000	
P1	P1.1	Bau-, Automaten-, Einsatz- und Vergütungsstähle, unlegiert	< 700	140	100	120	0,200	0,250
	P1.2	Bau-, Automaten-, Einsatz- und Vergütungsstähle, unlegiert	< 1200	140	100	120	0,200	0,250
P2	P2.1	Nitrier-, Einsatz- und Vergütungsstähle, legiert	< 900	140	100	120	0,200	0,250
	P2.2	Nitrier-, Einsatz- und Vergütungsstähle, legiert	< 1400	140	100	120	0,200	0,250
P3	P3.1	Werkzeug-, Wälzlager-, Feder- und Schnellarbeitsstähle**	< 800	140	100	120	0,200	0,250
	P3.2	Werkzeug-, Wälzlager-, Feder- und Schnellarbeitsstähle**	< 1000					
	P3.3	Werkzeug-, Wälzlager-, Feder- und Schnellarbeitsstähle**	< 1500					

HPR131 | HPR231

Schneidstoff: CU134 | Anschnitt: ME1G

MZG*	Werkstoff	Festigkeit/Härte [N/mm ²] [HRC]	Schnittgeschwindigkeit v _c (m/min)			Vorschub f _z (mm/u) bei Werkzeugdurchmesser		
			Innen- kühlung	Außen- kühlung	MMS	z 4	z 6	
						7,000 - 9,590	9,600 - 18,590	
P1	P1.1	Bau-, Automaten-, Einsatz- und Vergütungsstähle, unlegiert	< 700	140	100	120	0,150	0,200
	P1.2	Bau-, Automaten-, Einsatz- und Vergütungsstähle, unlegiert	< 1200	140	100	120	0,150	0,200
P2	P2.1	Nitrier-, Einsatz- und Vergütungsstähle, legiert	< 900	140	100	120	0,150	0,200
	P2.2	Nitrier-, Einsatz- und Vergütungsstähle, legiert	< 1400	140	100	120	0,150	0,200
P3	P3.1	Werkzeug-, Wälzlager-, Feder- und Schnellarbeitsstähle**	< 800	140	100	120	0,150	0,200
	P3.2	Werkzeug-, Wälzlager-, Feder- und Schnellarbeitsstähle**	< 1000					
	P3.3	Werkzeug-, Wälzlager-, Feder- und Schnellarbeitsstähle**	< 1500					

Die angegebenen Schnittwerte sind Richtwerte.

Die für den jeweiligen Bearbeitungsfall optimalen Daten sollten im Versuch oder während der Bearbeitung ermittelt werden.

Schnittwertempfehlung für Wechselkopfreibahnen HPR

Vorschub und Schnittgeschwindigkeit

HPR131 | HPR231 | HPR180 | HPR280

Schneidstoff: HP421 | Anschnitt: MF1G | M02G

MZG*			Werkstoff	Festigkeit/Härte [N/mm ²] [HRC]	Schnittgeschwindigkeit v _c (m/min)		
					Innenkühlung	Außenkühlung	MMS
P	P4	P4.1	Rostfreie Stähle, ferritisch und martensitisch		35	35	35
	P6	P6.1	Rostfreier Stahlguss, ferritisch und martensitisch		35	35	35
M	M1	M1.1	Rostfreie Stähle, austenitisch	< 700	35	35	35
		M1.2	Rostfreie Stähle, ferritisch/austenitisch (Duplex)	< 1000	35	35	35
	M2	M2.1	Rostfreier Stahlguss, austenitisch	< 700	35	35	35
	M3	M3.1	Rostfreier Stahlguss, ferritisch/austenitisch (Duplex)	< 1000	35	35	35

HPR110 | HPR210 | HPR150 | HPR250

Schneidstoff: HP421 | Anschnitt: MF1G | M02G

MZG*			Werkstoff	Festigkeit/Härte [N/mm ²] [HRC]	Schnittgeschwindigkeit v _c (m/min)		
					Innenkühlung	Außenkühlung	MMS
P	P4	P4.1	Rostfreie Stähle, ferritisch und martensitisch		35	35	35
	P6	P6.1	Rostfreier Stahlguss, ferritisch und martensitisch		35	35	35
M	M1	M1.1	Rostfreie Stähle, austenitisch	< 700	35	35	35
		M1.2	Rostfreie Stähle, ferritisch/austenitisch (Duplex)	< 1000	35	35	35
	M2	M2.1	Rostfreier Stahlguss, austenitisch	< 700	35	35	35
	M3	M3.1	Rostfreier Stahlguss, ferritisch/austenitisch (Duplex)	< 1000	35	35	35

Vorschub f_z (mm/u) bei Werkzeugdurchmesser			
HPR131 HPR231		HPR180 HPR280	
z4	z6	z4	z6
7,000-9,590	9,600-18,590	7,000-14,590	14,600-21,290
0,070	0,070	0,070	0,070
0,070	0,070	0,070	0,070
0,070	0,070	0,070	0,070
0,070	0,070	0,070	0,070
0,070	0,070	0,070	0,070
0,070	0,070	0,070	0,070

Vorschub f_z (mm/u) bei Werkzeugdurchmesser			
HPR110 HPR210		HPR150 HPR250	
z6	z8	z6	z8
15,600-29,990	30,000-65,000	16,600-36,990	37,000-65,000
0,070	0,070	0,070	0,070
0,070	0,070	0,070	0,070
0,070	0,070	0,070	0,070
0,070	0,070	0,070	0,070
0,070	0,070	0,070	0,070
0,070	0,070	0,070	0,070

Die angegebenen Schnittwerte sind Richtwerte.

Die für den jeweiligen Bearbeitungsfall optimalen Daten sollten im Versuch oder während der Bearbeitung ermittelt werden.

Schnittwertempfehlung für Wechselkopfreibahnen HPR

Vorschub und Schnittgeschwindigkeit

HPR130 | HPR230 | HPR180 | HPR280

Schneidstoff: HP423 | Anschnitt: MC1G

MZG*	Werkstoff	Festigkeit/Härte [N/mm ²] [HRC]	Schnittgeschwindigkeit v _c (m/min)				
			Innenkühlung	Außenkühlung	MMS		
K	K1	K1.1	Gusseisen mit Lamellengraphit (Grauguss), GJL	< 300	140	100	120
		K2.1	Gusseisen mit Kugelgraphit, GJS	< 500	140	100	120
	K2	K2.2	Gusseisen mit Kugelgraphit, GJS	≤ 800			
		K2.3	Gusseisen mit Kugelgraphit, GJS	> 800			

HPR100 | HPR200 | HPR150 | HPR250

Schneidstoff: CP134 | Anschnitt: MC1G

MZG*	Werkstoff	Festigkeit/Härte [N/mm ²] [HRC]	Schnittgeschwindigkeit v _c (m/min)				
			Innenkühlung	Außenkühlung	MMS		
K	K1	K1.1	Gusseisen mit Lamellengraphit (Grauguss), GJL	< 300	140	100	120
		K2.1	Gusseisen mit Kugelgraphit, GJS	< 500	140	100	120
	K2	K2.2	Gusseisen mit Kugelgraphit, GJS	≤ 800			
		K2.3	Gusseisen mit Kugelgraphit, GJS	> 800			

HPR130 | HPR180

Schneidstoff: HC419 | Anschnitt: MC1G

MZG*	Werkstoff	Festigkeit/Härte [N/mm ²] [HRC]	Schnittgeschwindigkeit v _c (m/min)				
			Innenkühlung	Außenkühlung	MMS		
K	K1	K1.1	Gusseisen mit Lamellengraphit (Grauguss), GJL	< 300	120	100	120

HPR100 | HPR150

Schneidstoff: HC419 | Anschnitt: MC1G

MZG*	Werkstoff	Festigkeit/Härte [N/mm ²] [HRC]	Schnittgeschwindigkeit v _c (m/min)				
			Innenkühlung	Außenkühlung	MMS		
K	K1	K1.1	Gusseisen mit Lamellengraphit (Grauguss), GJL	< 300	120	100	120

Vorschub f_z (mm/u) bei Werkzeugdurchmesser			
HPR130 HPR230		HPR180 HPR280	
z4	z6	z4	z6
7,000-9,590	9,600-18,590	7,000-14,590	14,600-21,290
0,150	0,200	0,150	0,200
0,150	0,200	0,150	0,200

Vorschub f_z (mm/u) bei Werkzeugdurchmesser			
HPR100 HPR200		HPR150 HPR250	
z6	z8	z6	z8
15,600-29,990	30,000-65,000	16,600-36,990	37,000-65,000
0,200	0,300	0,200	0,300
0,200	0,300	0,200	0,300

Vorschub f_z (mm/u) bei Werkzeugdurchmesser			
HPR130		HPR180	
z 4	z 6	z 4	z 6
7,000-9,590	9,600-18,590	7,000-14,590	14,600-21,290
0,150	0,200	0,150	0,200

Vorschub f_z (mm/u) bei Werkzeugdurchmesser			
HPR100		HPR150	
z6	z8	z6	z8
15,600-29,990	30,000-65,000	16,600-36,990	37,000-65,000
0,150	0,200	0,150	0,200

Die angegebenen Schnittwerte sind Richtwerte.

Die für den jeweiligen Bearbeitungsfall optimalen Daten sollten im Versuch oder während der Bearbeitung ermittelt werden.

Schnittwertempfehlung für Wechselkopfreibahnen HPR

Vorschub und Schnittgeschwindigkeit

HPR130 | HPR230 | HPR180 | HPR280

Schneidstoff: HP421 | Anschnitt: MC1G

MZG*	Werkstoff	Festigkeit/Härte [N/mm ²] [HRC]	Schnittgeschwindigkeit v _c (m/min)			
			Innenkühlung	Außenkühlung	MMS	
K2	K2.1	Gusseisen mit Kugelgraphit, GJS	< 500	120	100	120
	K2.2	Gusseisen mit Kugelgraphit, GJS	≤ 800			
	K2.3	Gusseisen mit Kugelgraphit, GJS	> 800			

HPR100 | HPR200 | HPR150 | HPR250

Schneidstoff: HP421 | Anschnitt: MC1G

MZG*	Werkstoff	Festigkeit/Härte [N/mm ²] [HRC]	Schnittgeschwindigkeit v _c (m/min)			
			Innenkühlung	Außenkühlung	MMS	
K2	K2.1	Gusseisen mit Kugelgraphit, GJS	< 500	120	100	120
	K2.2	Gusseisen mit Kugelgraphit, GJS	≤ 800			
	K2.3	Gusseisen mit Kugelgraphit, GJS	> 800			

HPR130 | HPR230 | HPR180 | HPR280

Schneidstoff: HP423 | Anschnitt: MC1G

MZG*	Werkstoff	Festigkeit/Härte [N/mm ²] [HRC]	Schnittgeschwindigkeit v _c (m/min)				
			Innenkühlung	Außenkühlung	MMS		
K	K2	K2.1	Gusseisen mit Kugelgraphit, GJS	< 500			
		K2.2	Gusseisen mit Kugelgraphit, GJS	≤ 800	120	100	120
		K2.3	Gusseisen mit Kugelgraphit, GJS	> 800	120	100	120
	K3	K3.1	Gusseisen mit Vermiculargraphit, GJV; Temperguss, GJM	< 500	90	70	90
		K3.2	Gusseisen mit Vermiculargraphit, GJV; Temperguss, GJM	> 500	90	70	90

HPR100 | HPR200 | HPR150 | HPR250

Schneidstoff: HP423 | Anschnitt: MC1G

MZG*	Werkstoff	Festigkeit/Härte [N/mm ²] [HRC]	Schnittgeschwindigkeit v _c (m/min)				
			Innenkühlung	Außenkühlung	MMS		
K	K2	K2.1	Gusseisen mit Kugelgraphit, GJS	< 500			
		K2.2	Gusseisen mit Kugelgraphit, GJS	≤ 800	120	100	120
		K2.3	Gusseisen mit Kugelgraphit, GJS	> 800	120	100	120
	K3	K3.1	Gusseisen mit Vermiculargraphit, GJV; Temperguss, GJM	< 500	90	70	90
		K3.2	Gusseisen mit Vermiculargraphit, GJV; Temperguss, GJM	> 500	90	70	90

Vorschub f_z (mm/u) bei Werkzeugdurchmesser			
HPR130 HPR230		HPR180 HPR280	
z4	z6	z4	z6
7,000-9,590	9,600-18,590	7,000-14,590	14,600-21,290
0,150	0,200	0,150	0,200

Vorschub f_z (mm/u) bei Werkzeugdurchmesser			
HPR100 HPR200		HPR150 HPR250	
z6	z8	z6	z8
15,600-29,990	30,000-65,000	16,600-36,990	37,000-65,000
0,150	0,200	0,150	0,200

Vorschub f_z (mm/u) bei Werkzeugdurchmesser			
HPR130 HPR230		HPR180 HPR280	
z4	z6	z4	z6
7,000-9,590	9,600-18,590	7,000-14,590	14,600-21,290
0,150	0,200	0,150	0,200
0,150	0,200	0,150	0,200
0,150	0,200	0,150	0,200
0,150	0,200	0,150	0,200

Vorschub f_z (mm/u) bei Werkzeugdurchmesser			
HPR100 HPR200		HPR150 HPR250	
z6	z8	z6	z8
15,600-29,990	30,000-65,000	16,600-36,990	37,000-65,000
0,150	0,200	0,150	0,200
0,150	0,200	0,150	0,200
0,150	0,200	0,150	0,200
0,150	0,200	0,150	0,200

Die angegebenen Schnittwerte sind Richtwerte.

Die für den jeweiligen Bearbeitungsfall optimalen Daten sollten im Versuch oder während der Bearbeitung ermittelt werden.

Schnittwertempfehlung für Wechselkopfreibahnen HPR

Vorschub und Schnittgeschwindigkeit

HPR130 | HPR230 | HPR180 | HPR280

Schneidstoff: PU620 | Anschnitt: MA0A

MZG*	Werkstoff	Festigkeit/Härte [N/mm ²] [HRC]	Schnittgeschwindigkeit v _c (m/min)			
			Innenkühlung	Außenkühlung	MMS	
N	N1	N1.1 Aluminium, unlegiert und legiert < 3 % Si	130	100	120	
		N1.2 Aluminium, legiert ≤ 7 % Si	130	100	120	
		N1.3 Aluminium, legiert > 7 - 12 % Si	130	100	120	
		N1.4 Aluminium, legiert > 12 % Si	130	100	120	
	N2	N2.1 Kupfer, unlegiert und niedriglegiert	< 300	130	100	120
		N2.2 Kupfer, legiert	> 300	130	100	120
		N2.3 Messing, Bronze, Rotguss	< 1200	130	100	120

HPR100 | HPR200 | HPR150 | HPR250

Schneidstoff: PU620 | Anschnitt: MA0A

MZG*	Werkstoff	Festigkeit/Härte [N/mm ²] [HRC]	Schnittgeschwindigkeit v _c (m/min)			
			Innenkühlung	Außenkühlung	MMS	
N	N1	N1.1 Aluminium, unlegiert und legiert < 3 % Si	130	100	120	
		N1.2 Aluminium, legiert ≤ 7 % Si	130	100	120	
		N1.3 Aluminium, legiert > 7-12 % Si	130	100	120	
		N1.4 Aluminium, legiert > 12 % Si	130	100	120	
	N2	N2.1 Kupfer, unlegiert und niedriglegiert	< 300	130	100	120
		N2.2 Kupfer, legiert	> 300	130	100	120
		N2.3 Messing, Bronze, Rotguss	< 1200	130	100	120

Vorschub f_z (mm/u) bei Werkzeugdurchmesser			
HPR130 HPR230		HPR180 HPR280	
z4	z6	z4	z6
7,000-9,590	9,600-18,590	7,000-14,590	14,600-21,290
0,150	0,250	0,150	0,250
0,150	0,250	0,150	0,250
0,150	0,250	0,150	0,250
0,150	0,250	0,150	0,250
0,150	0,250	0,150	0,250
0,150	0,250	0,150	0,250
0,150	0,250	0,150	0,250

Vorschub f_z (mm/u) bei Werkzeugdurchmesser			
HPR100 HPR200		HPR150 HPR250	
z6	z8	z6	z8
15,600-29,990	30,000-65,000	16,600-36,990	37,000-65,000
0,150	0,250	0,150	0,250
0,150	0,250	0,150	0,250
0,150	0,250	0,150	0,250
0,150	0,250	0,150	0,250
0,150	0,250	0,150	0,250
0,150	0,250	0,150	0,250
0,150	0,250	0,150	0,250

Die angegebenen Schnittwerte sind Richtwerte.

Die für den jeweiligen Bearbeitungsfall optimalen Daten sollten im Versuch oder während der Bearbeitung ermittelt werden.

Schnittwertempfehlung für Wechselkopfreibahnen HPR

Vorschub und Schnittgeschwindigkeit

HPR180 | HPR280

Schneidstoff: HP625 | Anschnitt: M02G

MZG*		Werkstoff	Festigkeit/Härte [N/mm ²] [HRC]	Schnittgeschwindigkeit v _c (m/min)			Vorschub f _z (mm/u) bei Werkzeugdurchmesser		
				Innen- kühlung	Außen- kühlung	MMS	z 4	z 6	
							7,000-14,590	14,600-21,290	
S	S1	S1.1	Titan, Titanlegierungen	< 400	35	20	25	0,060	0,080
	S2	S2.1	Titan, Titanlegierungen	< 1200	35	20	25	0,060	0,080
		S2.2	Titan, Titanlegierungen	> 1200	35	20	25	0,060	0,080
	S3	S3.1	Nickel, unlegiert und legiert	< 900	30	15	25	0,060	0,080
		S3.2	Nickel, unlegiert und legiert	> 900	30	15	25	0,060	0,080
	S4	S4.1	Hochwarmfeste Superlegierung, Ni-, Co-, und Fe-basiert		25	15	20	0,060	0,080
	S5	S5.1	Wolfram- und Molybdänlegierungen		25	15	20	0,060	0,080

HPR131 | HPR231

Schneidstoff: HP625 | Anschnitt: MF1G

MZG*		Werkstoff	Festigkeit/Härte [N/mm ²] [HRC]	Schnittgeschwindigkeit v _c (m/min)			Vorschub f _z (mm/u) bei Werkzeugdurchmesser		
				Innen- kühlung	Außen- kühlung	MMS	z 4	z 6	
							7,000-9,590	9,600-18,590	
S	S1	S1.1	Titan, Titanlegierungen	< 400	35	20	25	0,060	0,100
	S2	S2.1	Titan, Titanlegierungen	< 1200	35	20	25	0,060	0,100
		S2.2	Titan, Titanlegierungen	> 1200	35	20	25	0,060	0,100
	S3	S3.1	Nickel, unlegiert und legiert	< 900	30	15	25	0,060	0,100
		S3.2	Nickel, unlegiert und legiert	> 900	30	15	25	0,060	0,100
	S4	S4.1	Hochwarmfeste Superlegierung, Ni-, Co-, und Fe-basiert		25	15	20	0,060	0,100
	S5	S5.1	Wolfram- und Molybdänlegierungen		25	15	20	0,060	0,100

HPR110 | HPR210

Schneidstoff: HP625 | Anschnitt: MF1G

MZG*		Werkstoff	Festigkeit/Härte [N/mm ²] [HRC]	Schnittgeschwindigkeit v _c (m/min)			Vorschub f _z (mm/u) bei Werkzeugdurchmesser		
				Innen- kühlung	Außen- kühlung	MMS	z 6	z 8	
							15,600-29,990	30,000-65,000	
S	S1	S1.1	Titan, Titanlegierungen	< 400	35	20	25	0,100	0,100
	S2	S2.1	Titan, Titanlegierungen	< 1200	35	20	25	0,100	0,100
		S2.2	Titan, Titanlegierungen	> 1200	35	20	25	0,100	0,100
	S3	S3.1	Nickel, unlegiert und legiert	< 900	30	15	25	0,100	0,100
		S3.2	Nickel, unlegiert und legiert	> 900	30	15	25	0,100	0,100
	S4	S4.1	Hochwarmfeste Superlegierung, Ni-, Co-, und Fe-basiert		25	15	20	0,100	0,100
	S5	S5.1	Wolfram- und Molybdänlegierungen		25	15	20	0,100	0,100

HPR150 | HPR250

Schneidstoff: HP625 | Anschnitt: MO2G

MZG*		Werkstoff	Festigkeit/Härte [N/mm ²] [HRC]	Schnittgeschwindigkeit v _c (m/min)			Vorschub f _z (mm/u) bei Werkzeugdurchmesser		
				Innen- kühlung	Außen- kühlung	MMS	z 6	z 8	
							16,600-36,990	37,000-65,000	
S	S1	S1.1	Titan, Titanlegierungen	< 400	35	20	25	0,080	0,080
	S2	S2.1	Titan, Titanlegierungen	< 1200	35	20	25	0,080	0,080
		S2.2	Titan, Titanlegierungen	> 1200	35	20	25	0,080	0,080
	S3	S3.1	Nickel, unlegiert und legiert	< 900	30	15	25	0,080	0,080
		S3.2	Nickel, unlegiert und legiert	> 900	30	15	25	0,080	0,080
	S4	S4.1	Hochwarmfeste Superlegierung, Ni-, Co-, und Fe-basiert		25	15	20	0,080	0,080
	S5	S5.1	Wolfram- und Molybdänlegierungen		25	15	20	0,080	0,080

Die angegebenen Schnittwerte sind Richtwerte.

Die für den jeweiligen Bearbeitungsfall optimalen Daten sollten im Versuch oder während der Bearbeitung ermittelt werden.

Aufmaße beim Reiben

MZG*	Werkstoff	Festigkeit/Härte [N/mm ²] [HRC]
P	P1.1 Bau-, Automaten-, Einsatz- und Vergütungsstähle, unlegiert	< 700
	P1.2 Bau-, Automaten-, Einsatz- und Vergütungsstähle, unlegiert	< 1200
	P2.1 Nitrier-, Einsatz- und Vergütungsstähle, legiert	< 900
	P2.2 Nitrier-, Einsatz- und Vergütungsstähle, legiert	< 1400
	P3.1 Werkzeug-, Wälzlager-, Feder- und Schnellarbeitsstähle**	< 800
	P3.2 Werkzeug-, Wälzlager-, Feder- und Schnellarbeitsstähle**	< 1000
	P3.3 Werkzeug-, Wälzlager-, Feder- und Schnellarbeitsstähle**	< 1500
	P4.1 Rostfreie Stähle, ferritisch und martensitisch	
	P5.1 Stahlguss	
P6.1 Rostfreier Stahlguss, ferritisch und martensitisch		
M	M1.1 Rostfreie Stähle, austenitisch	< 700
	M1.2 Rostfreie Stähle, ferritisch/austenitisch (Duplex)	< 1000
	M2.1 Rostfreier Stahlguss, austenitisch	< 700
	M3.1 Rostfreier Stahlguss, ferritisch/austenitisch (Duplex)	< 1000
K	K1.1 Gusseisen mit Lamellengraphit (Grauguss), GJL	< 300
	K2.1 Gusseisen mit Kugelgraphit, GJS	< 500
	K2.2 Gusseisen mit Kugelgraphit, GJS	≤ 800
	K2.3 Gusseisen mit Kugelgraphit, GJS	> 800
	K3.1 Gusseisen mit Vermiculargraphit, GJV; Temperguss, GJM	< 500
	K3.2 Gusseisen mit Vermiculargraphit, GJV; Temperguss, GJM	> 500
N	N1.1 Aluminium, unlegiert und legiert < 3 % Si	
	N1.2 Aluminium, legiert ≤ 7 % Si	
	N1.3 Aluminium, legiert > 7-12 % Si	
	N1.4 Aluminium, legiert > 12 % Si	
	N2.1 Kupfer, unlegiert und niedriglegiert	< 300
	N2.2 Kupfer, legiert	> 300
	N2.3 Messing, Bronze, Rotguss	< 1200
	N4.1 Kunststoff, Thermoplaste	
	N4.2 Kunststoff, Duroplaste	
	N4.3 Kunststoff, Schaumstoffe	
C	C1.1 Kunststoffmatrix, Aramidfaserverstärkt (AFK)	
	C1.2 Kunststoffmatrix (duroplastisch), CFK/GFK	
	C1.3 Kunststoffmatrix (thermoplastisch), CFK/GFK	
	C2.1 Kohlenstoffmatrix, Kohlenstofffaserverstärkt (CFC)	
S	S1.1 Titan, Titanlegierungen	< 400
	S2.1 Titan, Titanlegierungen	< 1200
	S2.2 Titan, Titanlegierungen	> 1200
	S3.1 Nickel, unlegiert und legiert	< 900
	S3.2 Nickel, unlegiert und legiert	> 900
	S4.1 Hochwarmfeste Superlegierung, Ni-, Co-, und Fe-basiert	
S5.1 Wolfram- und Molybdänlegierungen		
H	H1.1 Gehärteter Stahl/Stahlguss	< 44
	H1.2 Gehärteter Stahl/Stahlguss	< 55
	H2.1 Gehärteter Stahl/Stahlguss	< 60
	H2.2 Gehärteter Stahl/Stahlguss	< 65
	H2.3 Gehärteter Stahl/Stahlguss	< 68
	H3.1 Verschleißbeständiger Guss/Hartguss, GJN	

* MAPAL Zerspanungsgruppen

** Wenn die Legierungsbestandteile Cr, Mo, Ni, V, W in Summe > 8 %, dann die nächst höhere MAPAL Zerspanungsgruppe wählen.

	Aufmaß a_p [mm] beim Reiben				
	< Ø5mm	Ø5-8mm	Ø8-12mm	Ø12-18mm	> Ø18mm
	0,100	0,100	0,150	0,150	0,150
	0,100	0,100	0,100	0,150	0,150
	0,100	0,100	0,150	0,150	0,150
	0,100	0,100	0,100	0,150	0,150
	0,100	0,100	0,150	0,150	0,150
	0,100	0,100	0,150	0,150	0,150
	0,100	0,100	0,100	0,150	0,150
	0,100	0,100	0,100	0,100	0,100
	0,100	0,100	0,100	0,150	0,150
	0,100	0,100	0,100	0,100	0,100
	0,100	0,100	0,100	0,100	0,100
	0,100	0,100	0,100	0,100	0,100
	0,100	0,100	0,100	0,100	0,100
	0,100	0,100	0,100	0,100	0,100
	0,150	0,150	0,150	0,150	0,150
	0,150	0,150	0,150	0,150	0,150
	0,150	0,150	0,150	0,150	0,150
	0,100	0,150	0,150	0,150	0,150
	0,150	0,150	0,150	0,150	0,150
	0,100	0,150	0,150	0,150	0,150
	0,150	0,150	0,150	0,150	0,150
	0,150	0,150	0,150	0,150	0,150
	0,150	0,150	0,150	0,150	0,150
	0,150	0,150	0,150	0,150	0,150
	0,150	0,150	0,150	0,150	0,150
	0,150	0,150	0,150	0,150	0,150
	0,200	0,200	0,200	0,200	0,200
	0,200	0,200	0,200	0,200	0,200
	0,200	0,200	0,200	0,200	0,200
	0,200	0,200	0,200	0,200	0,200
	0,200	0,200	0,200	0,200	0,200
	0,200	0,200	0,200	0,200	0,200
	0,200	0,200	0,200	0,200	0,200
	0,100	0,100	0,100	0,100	0,100
	0,100	0,100	0,100	0,100	0,100
	0,100	0,100	0,100	0,100	0,100
	0,100	0,100	0,100	0,100	0,100
	0,100	0,100	0,100	0,100	0,100
	0,100	0,100	0,100	0,100	0,100
	0,100	0,100	0,100	0,100	0,100
	0,075	0,075	0,075	0,075	0,075
	0,050	0,050	0,075	0,075	0,075
	0,050	0,050	0,075	0,075	0,075
	0,050	0,050	0,075	0,075	0,075
	0,050	0,050	0,075	0,075	0,075
	0,050	0,050	0,075	0,075	0,075
	0,100	0,050	0,075	0,075	0,075

Die angegebenen Schnittwerte sind Richtwerte.

Die für den jeweiligen Bearbeitungsfall optimalen Daten sollten im Versuch oder während der Bearbeitung ermittelt werden.

Werkzeugfeatures im Detail HFS-Systeme



HFS-Axialspannsystem

Auch für Modul und HSK Schnittstellen erhältlich



1 Verschiedene Haltervarianten
z. B. Zylinderschaft, HSK-A

2 Kegel zur einfachen und hochgenauen Zentrierung

3 Plananlage für Steifigkeit und Stabilität

4 Innere Kühlmittelführung
Austritt direkt an der Schneide

5 Hochfeste und präzise Spannschraube
mit Differenzialgewinde



HFS-Radialspannsystem

Kopfwechsel schnell, einfach und grundsätzlich in der Maschine



6 Exzenterbolzen
für schnelles Spannen und Lösen mit hoher Einzugskraft

7 Kegel zur einfachen und hochgenauen Zentrierung

8 Plananlage für Steifigkeit und Stabilität

9 Innere Kühlmittelführung
Austritt direkt an der Schneide

10 Präzisions-Anzugsbolzen

11 Verschiedene Haltervarianten
z. B. Zylinderschaft, HSK-A



Bezeichnungsschlüssel

HFS-Wechselkopfhalter

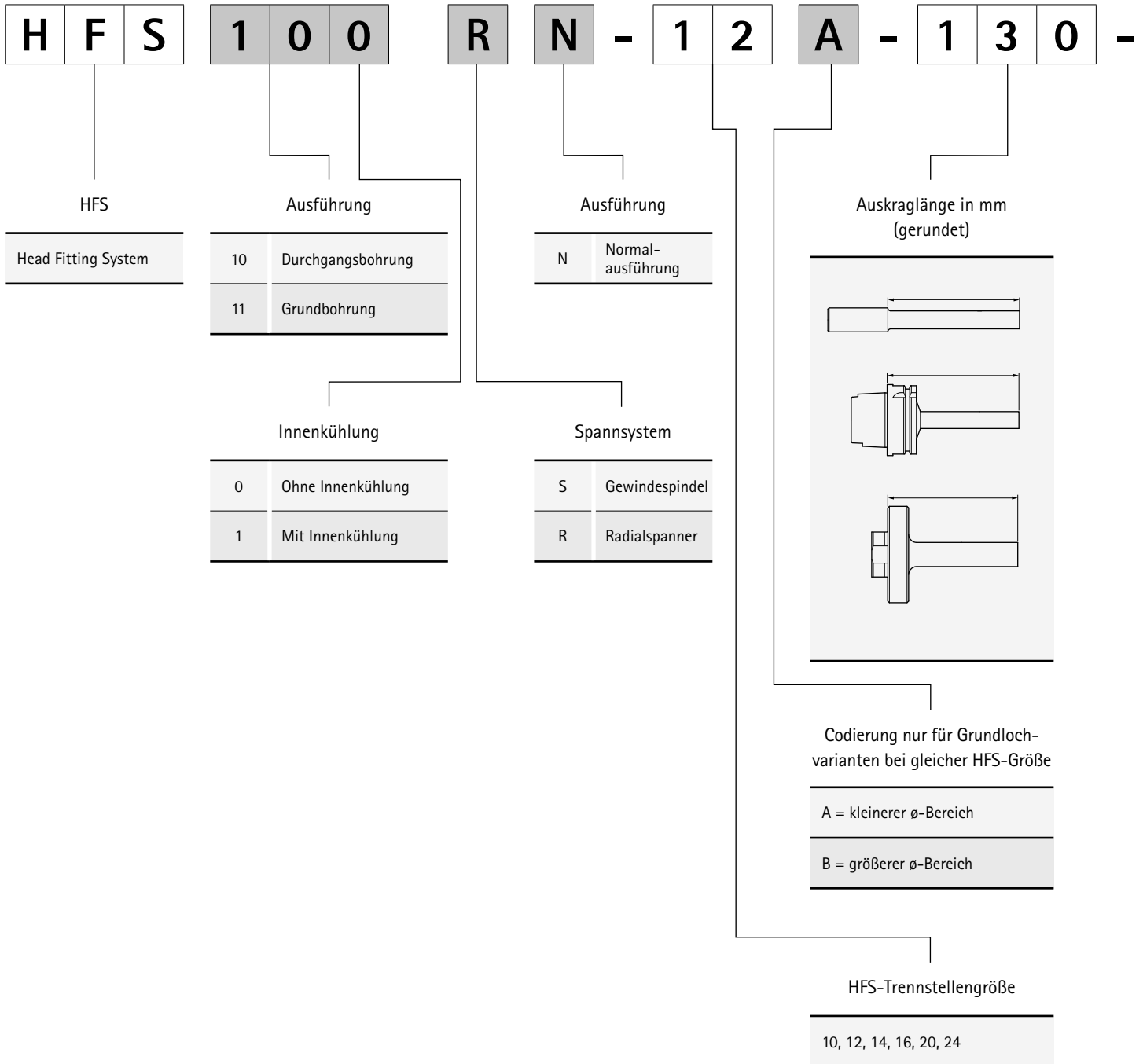

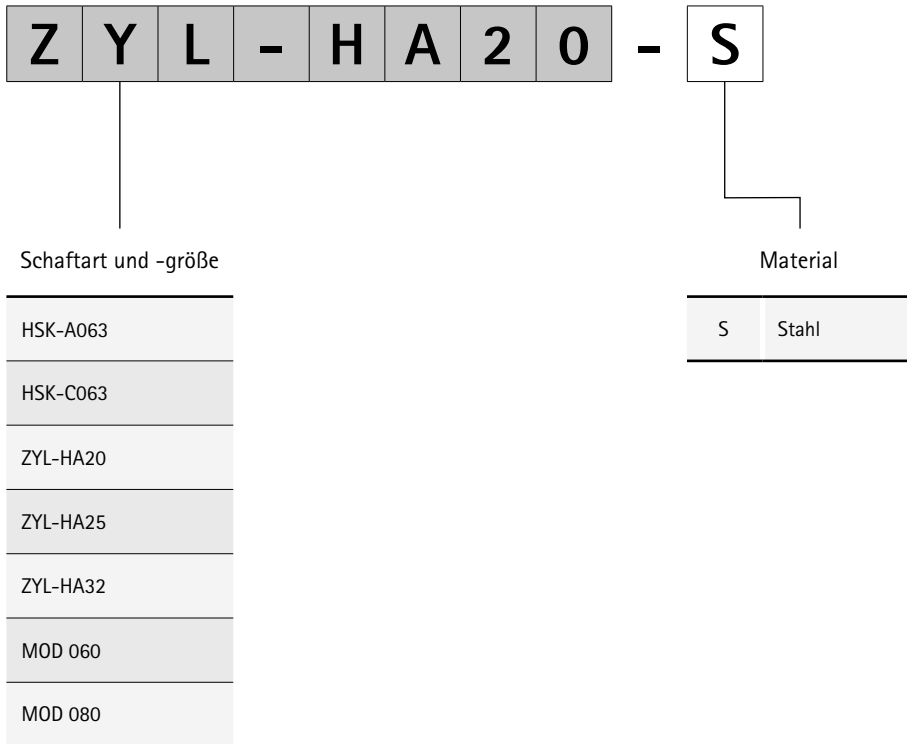

HFS-Wechselkopfhalter

Mit Axialspannsystem

Schaft nach MN 623, ähnlich DIN 1835-A

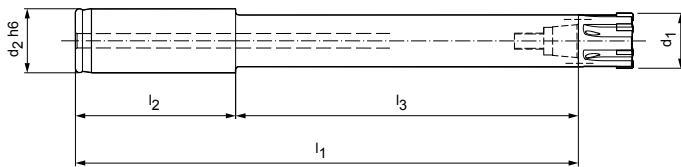

Lange Ausführung mit Zylinderschaft

Baumaße						Spezifikation	Bestell-Nr.
d_1	HFS-Größe	$d_2 h6$	l_1	l_2	l_3		
15,60 - 18,59	10	20	160	50	110	HFS101SN-10-110-ZYL-HA20-S	30010248
18,60 - 21,29	12	20	179,5	50	129,5	HFS101SN-12-130-ZYL-HA20-S	30010249
21,30 - 23,99	14	20	180,5	50	130,5	HFS101SN-14-131-ZYL-HA20-S	30010250
24,00 - 29,99	16	25	211	60	151	HFS101SN-16-151-ZYL-HA25-S	30010251
30,00 - 39,99	20	25	210	60	150	HFS101SN-20-150-ZYL-HA25-S	30010252
40,00 - 50,70	24	32	266	60	206	HFS101SN-24-206-ZYL-HA32-S	30010253
50,71 - 65,00							

Kurze Ausführung mit Zylinderschaft

Baumaße						Spezifikation	Bestell-Nr.
d_1	HFS-Größe	$d_2 h6$	l_1	l_2	l_3		
15,60 - 18,59	10	20	99	50	49	HFS101SN-10-049-ZYL-HA20-S	30010256
18,60 - 21,29	12	20	118,5	50	68,5	HFS101SN-12-069-ZYL-HA20-S	30010257
21,30 - 23,99	14	20	119,5	50	69,5	HFS101SN-14-070-ZYL-HA20-S	30010258
24,00 - 29,99	16	25	150	60	90	HFS101SN-16-090-ZYL-HA25-S	30010259
30,00 - 39,99	20	25	149	60	89	HFS101SN-20-089-ZYL-HA25-S	30010260
40,00 - 50,70	24	32	167	60	107	HFS101SN-24-107-ZYL-HA32-S	30010261
50,71 - 65,00							

Extrakurze Ausführung mit Zylinderschaft

Baumaße						Spezifikation	Bestell-Nr.
d_1	HFS-Größe	$d_2 h6$	l_1	l_2	l_3		
18,60 - 21,29	12	20	82	50	32	HFS101SN-12-032-ZYL-HA20-S	30078683

Maßangaben in mm.

Lieferumfang: Halter mit Gewindespindel und Schraubendreher mit Quergriff.

HFS-Wechselkopfhalter

Mit Axialspannsystem

Schaft nach MN 623, ähnlich DIN 1835-A

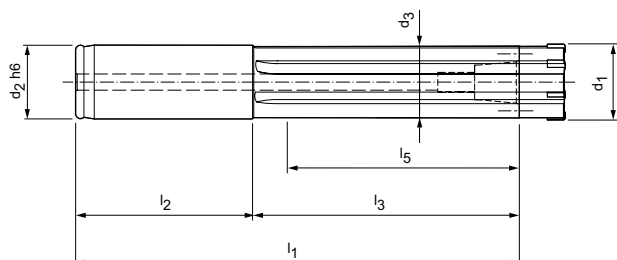

Lange Ausführung mit Zylinderschaft

Baumaße								Spezifikation	Bestell-Nr.
d_1	HFS-Größe	d_2 h6	d_3	l_1	l_2	l_3	l_5		
16,60 - 19,39	10	20	16	160	50	110	94	HFS111SN-10A-110-ZYL-HA20-S	30026380
19,40 - 21,29	10	20	18,6	160	50	110	94	HFS111SN-10B-110-ZYL-HA20-S	30026488
21,30 - 24,99	12	20	20,5	180,5	50	130,5	114,5	HFS111SN-12-131-ZYL-HA20-S	30026489
25,00 - 28,99	14	25	24,2	211,5	60	151,5	132,5	HFS111SN-14-152-ZYL-HA25-S	30026510
29,00 - 32,29	16	25	28,2	210	60	150	131	HFS111SN-16A-150-ZYL-HA25-S	30026511
32,30 - 36,99	16	25	31,5	210	60	150	140	HFS111SN-16B-150-ZYL-HA25-S	30026512
37,00 - 41,19	20	25	36,2	210	60	150	140	HFS111SN-20A-150-ZYL-HA25-S	30026513
41,20 - 44,99	20	25	40,2	210	60	150	140	HFS111SN-20B-150-ZYL-HA25-S	30026514
45,00 - 50,70	24	32	44	266	60	206	195	HFS111SN-24-206-ZYL-HA32-S	30026515
50,71 - 65,00									

Kurze Ausführung mit Zylinderschaft

Baumaße								Spezifikation	Bestell-Nr.
d_1	HFS-Größe	d_2 h6	d_3	l_1	l_2	l_3	l_5		
16,60 - 19,39	10	20	16	99	50	49	33	HFS111SN-10A-049-ZYL-HA20-S	30026516
19,40 - 21,29	10	20	18,6	99	50	49	33	HFS111SN-10B-049-ZYL-HA20-S	30026521
21,30 - 24,99	12	20	20,5	117,5	50	67,5	51,5	HFS111SN-12-068-ZYL-HA20-S	30026522
25,00 - 28,99	14	25	24,2	150,5	60	90,5	71,5	HFS111SN-14-091-ZYL-HA25-S	30026523
29,00 - 32,29	16	25	28,2	149	60	89	70	HFS111SN-16A-089-ZYL-HA25-S	30026525
32,30 - 36,99	16	25	31,5	149	60	89	79	HFS111SN-16B-089-ZYL-HA25-S	30026526
37,00 - 41,19	20	25	36,2	149	60	89	79	HFS111SN-20A-089-ZYL-HA25-S	30026527
41,20 - 44,99	20	25	40,2	149	60	89	79	HFS111SN-20B-089-ZYL-HA25-S	30026528
45,00 - 50,70	24	32	44	167	60	107	96	HFS111SN-24-107-ZYL-HA32-S	30026529
50,71 - 65,00									

Maßangaben in mm.

Lieferumfang: Halter mit Gewindespindel und Schraubendreher mit Quergriff.

HFS-Wechselkopfhalter

Mit Axialspannsystem mit Radial- und Winkelausrichtung
Modul-Anschlussmaße nach MN 5000-14

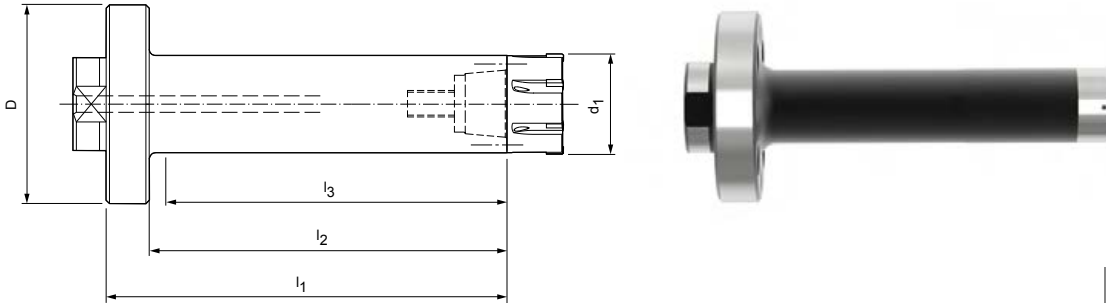

Lange Ausführung mit Modulaufnahme (radial- und winkelausrichtbar)

Baumaße						Spezifikation	Bestell-Nr.
d ₁	HFS-Größe	D	l ₁	l ₂	l ₃		
15,60 - 18,59	10	60	81	68	61	HFS101SN-10-081-MOD-060-S	30010264
18,60 - 21,29	12	60	100,5	87,5	80,5	HFS101SN-12-101-MOD-060-S	30010265
21,30 - 23,99	14	60	101,5	88,5	79,5	HFS101SN-14-102-MOD-060-S	30010266
24,00 - 29,99	16	60	122	109	104	HFS101SN-16-122-MOD-060-S	30010267
30,00 - 39,99	20	60	121	108	103	HFS101SN-20-121-MOD-060-S	30010268
40,00 - 50,70	24	60	133	120	116	HFS101SN-24-133-MOD-060-S	30010269
50,71 - 65,00	24	80	133	116	112	HFS101SN-24-133-MOD-080-S	30190195



Ersatzteile für Modulaufnahme

Modul Größe D	Zylinderschraube ISO 4762 (DIN 912)			Druckstück		Gewindestift	
	benötigte Anzahl	Größe	Bestell-Nr.	Größe	Bestell-Nr.	Größe	Bestell-Nr.
60	4	M5x16-12,9	10003601	10,6x5	10040108	M8x1x8	10040109
80	4	M6x20-12,9	10003619	10,6x5	10040108	M8x1x11,5	10075074

Maßangaben in mm.

Lieferumfang: Halter mit Gewindestift, Schraubendreher mit Quergriff, Befestigungsschrauben für Modulaufnahme und Teile für Winkelausrichtung der Modulaufnahme.

HFS-Wechselkopfhalter

Mit Axialspannsystem mit Radial- und Winkelausrichtung
Modul-Anschlussmaße nach MN 5000-14

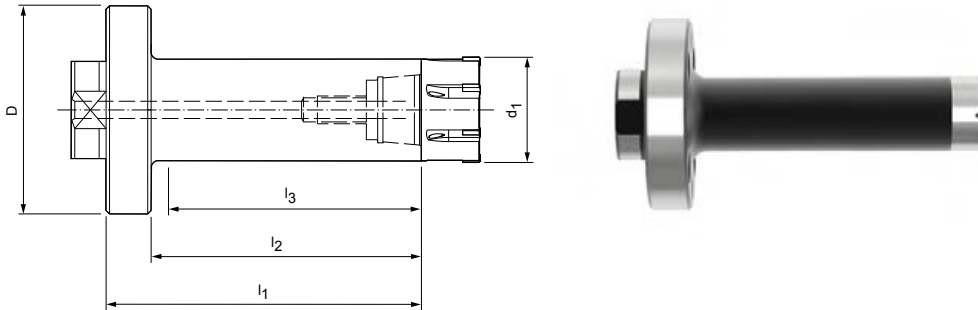

Kurze Ausführung mit Modulaufnahme (radial- und winkelausrichtbar)

Baumaße						Spezifikation	Bestell-Nr.
d ₁	HFS-Größe	D	l ₁	l ₂	l ₃		
15,60 - 18,59	10	60	49	36	31	HFS101SN-10-049-MOD-060-S	30027896
18,60 - 21,29	12	60	58,5	45,5	40,5	HFS101SN-12-059-MOD-060-S	30027897
21,30 - 23,99	14	60	62,5	49,5	44,5	HFS101SN-14-063-MOD-060-S	30027898
24,00 - 29,99	16	60	72	59	54	HFS101SN-16-072-MOD-060-S	30027899
30,00 - 39,99	20	60	71	58	53	HFS101SN-20-071-MOD-060-S	30027900
40,00 - 50,70	24	60	84	71	66	HFS101SN-24-084-MOD-060-S	30027901
50,71 - 65,00	24	80	84	67	62	HFS101SN-24-084-MOD-080-S	30152510



Ersatzteile für Modulaufnahme

Modul Größe D	Zylinderschraube ISO 4762 (DIN 912)			Druckstück		Gewindestift	
	benötigte Anzahl	Größe	Bestell-Nr.	Größe	Bestell-Nr.	Größe	Bestell-Nr.
60	4	M5x16-12,9	10003601	10,6x5	10040108	M8x1x8	10040109
80	4	M6x20-12,9	10003619	10,6x5	10040108	M8x1x11,5	10075074

Maßangaben in mm.

Lieferumfang: Halter mit Gewindestift, Schraubendreher mit Quergriff, Befestigungsschrauben für Modulaufnahme und Teile für Winkelausrichtung der Modulaufnahme.

HFS-Wechselkopfhalter

Mit Axialspannsystem mit Radial- und Winkelausrichtung
Modul-Anschlussmaße nach MN 5000-14

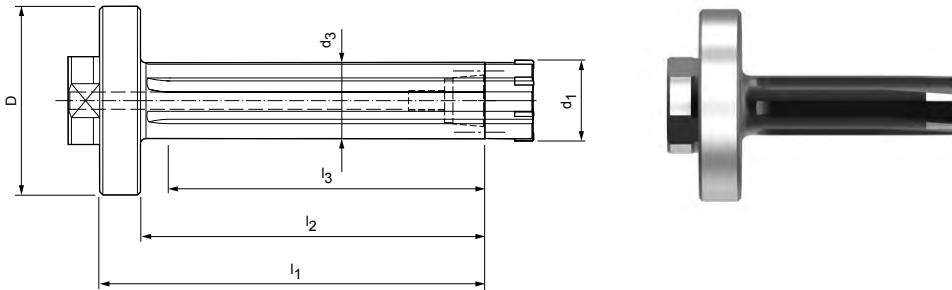

Lange Ausführung mit Modulaufnahme (radial- und winkelausrichtbar)

Baumaße							Spezifikation	Bestell-Nr.
d ₁	HFS-Größe	D	d ₃	l ₁	l ₂	l ₃		
16,60 - 19,39	10	60	16	81	68	48	HFS111SN-10A-081-MOD-060-S	30026562
19,40 - 21,29	10	60	18,6	81	68	48	HFS111SN-10B-081-MOD-060-S	30026563
21,30 - 24,99	12	60	20,5	101,5	88,5	69,5	HFS111SN-12-102-MOD-060-S	30026564
25,00 - 28,99	14	60	24,2	122,5	109,5	90,5	HFS111SN-14-123-MOD-060-S	30026565
29,00 - 32,29	16	60	28,2	121	108	89	HFS111SN-16A-121-MOD-060-S	30026566
32,30 - 36,99	16	60	31,5	121	108	89	HFS111SN-16B-121-MOD-060-S	30026567
37,00 - 41,19	20	60	36,2	121	108	89	HFS111SN-20A-121-MOD-060-S	30026568
41,20 - 44,99	20	60	40,2	121	108	89	HFS111SN-20B-121-MOD-060-S	30026569
45,00 - 50,70	24	60	44	123	110	95	HFS111SN-24-123-MOD-060-S	30026570
50,71 - 65,00	24	80	44	133	116	110	HFS111SN-24-133-MOD-080-S	30193167



Ersatzteile für Modulaufnahme

Modul Größe D	Zylinderschraube ISO 4762 (DIN 912)			Druckstück		Gewindestift	
	benötigte Anzahl	Größe	Bestell-Nr.	Größe	Bestell-Nr.	Größe	Bestell-Nr.
60	4	M5x16-12,9	10003601	10,6x5	10040108	M8x1x8	10040109
80	4	M6x20-12,9	10003619	10,6x5	10040108	M8x1x11,5	10075074

Maßangaben in mm.

Lieferumfang: Halter mit Gewindespindel, Schraubendreher mit Quergriff, Befestigungsschrauben für Modulaufnahme und Teile für Winkelausrichtung der Modulaufnahme.

HFS-Wechselkopfhalter

Mit Axialspannsystem mit Radial- und Winkelausrichtung
Modul-Anschlussmaße nach MN 5000-14

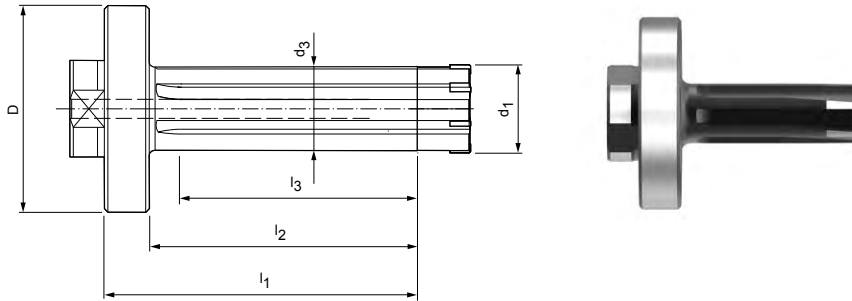

Kurze Ausführung mit Modulaufnahme (radial- und winkelausrichtbar)

Baumaße							Spezifikation	Bestell-Nr.
d ₁	HFS-Größe	D	d ₃	l ₁	l ₂	l ₃		
16,60 - 19,39	10	60	16	49	36	31	HFS111SN-10A-049-MOD-060-S	30027885
19,40 - 21,29	10	60	18,6	59	46	41	HFS111SN-10B-059-MOD-060-S	30027886
21,30 - 24,99	12	60	20,5	62,5	49,5	44,5	HFS111SN-12-063-MOD-060-S	30027887
25,00 - 28,99	14	60	24,2	72,5	59,5	54,5	HFS111SN-14-073-MOD-060-S	30027888
29,00 - 32,29	16	60	28,2	71	58	53	HFS111SN-16A-071-MOD-060-S	30027889
32,30 - 36,99	16	60	31,5	71	58	53	HFS111SN-16B-071-MOD-060-S	30027890
37,00 - 41,19	20	60	36,2	71	58	53	HFS111SN-20A-071-MOD-060-S	30027891
41,20 - 44,99	20	60	40,2	81	68	63	HFS111SN-20B-081-MOD-060-S	30027892
45,00 - 50,70	24	60	44	84	71	66	HFS111SN-24-084-MOD-060-S	30027893
50,71 - 65,00	24	80	44	84	67	64	HFS111SN-24-084-MOD-080-S	30193168



Ersatzteile für Modulaufnahme

Modul Größe D	Zylinderschraube ISO 4762 (DIN 912)			Druckstück		Gewindestift	
	benötigte Anzahl	Größe	Bestell-Nr.	Größe	Bestell-Nr.	Größe	Bestell-Nr.
60	4	M5x16-12,9	10003601	10,6x5	10040108	M8x1x8	10040109
80	4	M6x20-12,9	10003619	10,6x5	10040108	M8x1x11,5	10075074

Maßangaben in mm.

Lieferumfang: Halter mit Gewindestift, Schraubendreher mit Quergriff, Befestigungsschrauben für Modulaufnahme und Teile für Winkelausrichtung der Modulaufnahme.

HFS-Wechselkopfhalter

Mit Axialspannsystem

Schaft HSK-A nach DIN 69893-1

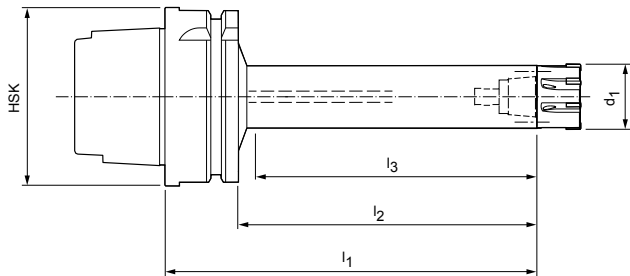

Lange Ausführung mit HSK-A 63

Baumaße						Spezifikation	Bestell-Nr.
d ₁	HFS-Größe	l ₁	l ₂	l ₃	HSK-A Größe		
15,60 - 18,59	10	117	91	86	63	HFS101SN-10-117-HSK-A063-S	30010272
18,60 - 21,29	12	132,5	106,5	100,5	63	HFS101SN-12-133-HSK-A063-S	30010273
21,30 - 23,99	14	131,5	105,5	99,5	63	HFS101SN-14-132-HSK-A063-S	30010275
24,00 - 29,99	16	163	137	129	63	HFS101SN-16-163-HSK-A063-S	30010276
30,00 - 39,99	20	188	162	158	63	HFS101SN-20-188-HSK-A063-S	30010280
40,00 - 50,70	24	207	181	176	63	HFS101SN-24-207-HSK-A063-S	30010286
50,71 - 65,00							

Kurze Ausführung mit HSK-A 63

Baumaße						Spezifikation	Bestell-Nr.
d ₁	HFS-Größe	l ₁	l ₂	l ₃	HSK-A Größe		
15,60 - 18,59	10	77	51	46	63	HFS101SN-10-077-HSK-A063-S	30010283
18,60 - 21,29	12	92,5	66,5	60,5	63	HFS101SN-12-093-HSK-A063-S	30010285
21,30 - 23,99	14	91,5	65,5	59,5	63	HFS101SN-14-092-HSK-A063-S	30010287
24,00 - 29,99	16	112	86	79	63	HFS101SN-16-112-HSK-A063-S	30010288
30,00 - 39,99	20	111	85	78	63	HFS101SN-20-111-HSK-A063-S	30010289
40,00 - 50,70	24	109	83	76	63	HFS101SN-24-109-HSK-A063-S	30010291
50,71 - 65,00							

Maßangaben in mm.

Lieferumfang: Halter mit Gewindespindel und Schraubendreher mit Quergriff.

HFS-Wechselkopfhalter

Mit Axialspannsystem
Schaft HSK-A nach DIN 69893-1

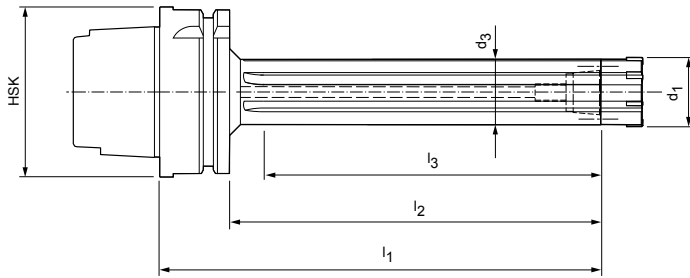

Lange Ausführung mit HSK-A 63

Baumaße							Spezifikation	Bestell-Nr.
d ₁	HFS-Größe	d ₃	l ₁	l ₂	l ₃	HSK-A Größe		
16,60 - 19,39	10	16,0	117	91	71	63	HFS111SN-10A-117-HSK-A063-S	30026586
19,40 - 21,29	10	18,6	117	91	71	63	HFS111SN-10B-117-HSK-A063-S	30026587
21,30 - 24,99	12	20,5	131,5	105,5	86,5	63	HFS111SN-12-132-HSK-A063-S	30026588
25,00 - 28,99	14	24,2	163,5	137,5	118,5	63	HFS111SN-14-164-HSK-A063-S	30026589
29,00 - 32,29	16	28,2	188	162	143	63	HFS111SN-16A-188-HSK-A063-S	30026590
32,30 - 36,99	16	31,5	188	162	143	63	HFS111SN-16B-188-HSK-A063-S	30026591
37,00 - 41,19	20	36,2	188	162	152	63	HFS111SN-20A-188-HSK-A063-S	30026592
41,20 - 44,99	20	40,2	188	162	152	63	HFS111SN-20B-188-HSK-A063-S	30026593
45,00 - 50,70	24	44,0	233	207	197	63	HFS111SN-24-233-HSK-A063-S	30026594
50,71 - 65,00								

Kurze Ausführung mit HSK-A 63

Baumaße							Spezifikation	Bestell-Nr.
d ₁	HFS-Größe	d ₃	l ₁	l ₂	l ₃	HSK-A Größe		
16,60 - 19,39	10	16,0	77	51	31	63	HFS111SN-10A-077-HSK-A063-S	30026574
19,40 - 21,29	10	18,6	77	51	31	63	HFS111SN-10B-077-HSK-A063-S	30026575
21,30 - 24,99	12	20,5	91,5	65,5	46,5	63	HFS111SN-12-092-HSK-A063-S	30026576
25,00 - 28,99	14	24,2	112,5	86,5	67,5	63	HFS111SN-14-113-HSK-A063-S	30026577
29,00 - 32,29	16	28,2	111	85	66	63	HFS111SN-16A-111-HSK-A063-S	30026578
32,30 - 36,99	16	31,5	111	85	66	63	HFS111SN-16B-111-HSK-A063-S	30026579
37,00 - 41,19	20	36,2	111	85	75	63	HFS111SN-20A-111-HSK-A063-S	30026580
41,20 - 44,99	20	40,2	111	85	75	63	HFS111SN-20B-111-HSK-A063-S	30026581
45,00 - 50,70	24	44,0	109	83	73	63	HFS111SN-24-109-HSK-A063-S	30026582
50,71 - 65,00								

Maßangaben in mm.

Lieferumfang: Halter mit Gewindespindel und Schraubendreher mit Quergriff.

HFS-Wechselkopfhalter

Mit Radialspannsystem, Schaft nach MN 623, ähnlich DIN 1835-A
Für HPR-Wechselkopfreibahle HPR100, HPR110, HPR200, HPR210

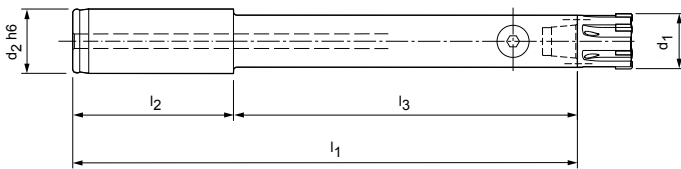

Lange Ausführung mit Zylinderschaft

Baumaße						Spezifikation	Bestell-Nr.
d ₁	HFS-Größe	d ₂ h6	l ₁	l ₂	l ₃		
18,60 - 21,29	12	20	179,5	50	129,5	HFS101RN-12-130-ZYL-HA20-S	30078110
21,30 - 23,99	14	20	180,5	50	130,5	HFS101RN-14-131-ZYL-HA20-S	30078115
24,00 - 29,99	16	25	211	60	151	HFS101RN-16-151-ZYL-HA25-S	30078116
30,00 - 39,99	20	25	210	60	150	HFS101RN-20-150-ZYL-HA25-S	30080112

Kurze Ausführung mit Zylinderschaft

Baumaße						Spezifikation	Bestell-Nr.
d ₁	HFS-Größe	d ₂ h6	l ₁	l ₂	l ₃		
18,60 - 21,29	12	20	118,5	50	68,5	HFS101RN-12-069-ZYL-HA20-S	30078117
21,30 - 23,99	14	20	119,5	50	69,5	HFS101RN-14-070-ZYL-HA20-S	30078118
24,00 - 29,99	16	25	150	60	90	HFS101RN-16-090-ZYL-HA25-S	30078119
30,00 - 39,99	20	25	149	60	89	HFS101RN-20-089-ZYL-HA25-S	30080151

Extrakurze Ausführung mit Zylinderschaft

Baumaße						Spezifikation	Bestell-Nr.
d ₁	HFS-Größe	d ₂ h6	l ₁	l ₂	l ₃		
18,60 - 21,29	12	20	85	50	35	HFS101RN-12-035-ZYL-HA20-S	30115560

Maßangaben in mm.

Empfehlung: Um einen schnellen Wechsel der Reibahlen mit dem Radialspannsystem zu ermöglichen, sollte mindestens ein zusätzlicher Anzugsbolzen bestellt werden.
Lieferumfang: Halter mit Anzugsbolzen, Schraubendreher mit Quergriff und Gabelschlüssel für Anzugsbolzen.



Zubehör und Ersatzteile für HFS



Gewindespindel für Axialspannsystem

HFS-Größe	ohne Kühlmitteldurchgang Gewindespindel MN 618 Bestell-Nr.	mit Kühlmitteldurchgang Gewindespindel MN 618 Bestell-Nr.
10	10024720	10025194
12	10024721	10025195
14	10024721	10025195
16	10024722	10025196
20	10024722	10025196
24	10024723	10025198



Anzugsbolzen für Radialspannsystem

HFS-Größe	ohne Kühlmittelbohrung Bestell-Nr.	mit Kühlmittelbohrung Bestell-Nr.
12	10059113	10059273
14	10059113	10059273
16	10059117	10059279
20	10059117	10059279

Empfehlung: Um einen schnellen Wechsel der Reibahlen mit dem Radialspannsystem zu ermöglichen, sollte mindestens ein zusätzlicher Anzugsbolzen bestellt werden.

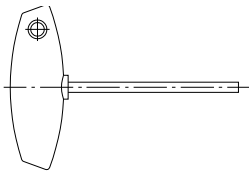

Schraubendreher mit Quergriff

HFS-Größe	kurze Ausführung		lange Ausführung	
	Größe	Bestell-Nr.	Größe	Bestell-Nr.
10	sw2,5 x 100	10006233	sw2,5 x 200	10032722
12	sw3 x 100	10006234	sw3 x 200	10025313
14	sw3 x 100	10006234	sw3 x 200	10025313
16	sw4 x 100	10006235	sw4 x 200	10018010
20	sw4 x 100	10006235	sw4 x 200	10018010
24	sw5 x 100	10006236	sw5 x 200	10013349



Kegelwischer für HFS-Innenkegel

HFS-Größe	Bestell-Nr.
10	10029989
12	10029990
14	10030002
16	10030003
20	10030004
24	10030005

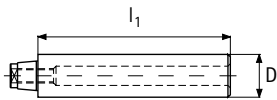

Prüfdorne (Ausrichthilfe)

HFS-Größe	l_1	D	Bestell-Nr.
10	70	15	30036468
12	80	20	30036469
14	80	20,5	30036470
16	80	23,2	30036471
20	80	29,3	30036472
24	80	39	30036473

Maßangaben in mm.

Ausführung: Zulässige Rundlaufabweichung des zylindrischen Teils zur HFS-Schnittstelle max. 0,002 mm.

Zubehör und Ersatzteile für HSK-A 63

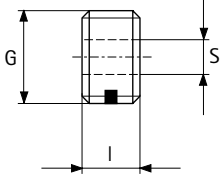

Blindschraube

HSK-A Größe	I	S	G	Bestell-Nr.
63	11,5	8	M18x1	30326078

HFS-Größe	sw	Drehmomentschlüssel				Klingen und Sechskanteinsätze für Drehmomentschlüssel			
		Drehmoment	Ausführung	Antrieb	Bestell-Nr.	l [mm]	l ₁ [mm]	Antrieb	Bestell-Nr.
10	2.5	4 Nm	fest - mit Klinge	-	10044842	175	70	Klinge	10044839
12	3	6 Nm	einstellbar - ohne Einsatz	1/4"	10040125	55	30	Einsatz 1/4"	10040122
14	3	6 Nm	einstellbar - ohne Einsatz	1/4"	10040125	55	30	Einsatz 1/4"	10040122
16	4	15 Nm	einstellbar - ohne Einsatz	3/8"	10040126	60	35	Einsatz 3/8"	10040123
20	4	15 Nm	einstellbar - ohne Einsatz	3/8"	10040126	60	35	Einsatz 3/8"	10040123
24	5	20 Nm	einstellbar - ohne Einsatz	3/8"	10040126	70	45	Einsatz 3/8"	10040124

Drehmomentschlüssel und Sechskanteinsätze erst ab HFS-Größe 12 bzw. sw 3.

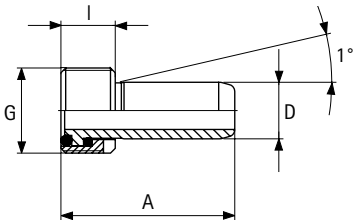

Kühlmittelrohr

HSK-A Größe	A	I	G	D	Bestell-Nr.
63	36.6	11,5	M18x1	12	30326006

Lieferumfang: Kühlmittelrohr mit zwei O-Ringen und Überwurfmutter.
Ausführung: Leichtgängige Winkelbeweglichkeit 1° selbstzentrierend, axial abgedichtet.
Hinweis: Ausgeführt entsprechend DIN 69893.

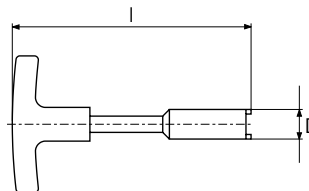

Montageschlüssel

HSK-A Größe	I	D	Bestell-Nr.
63	182	17	10040110

Verwendung: Zur Montage und Demontage von Kühlmittelrohren.

Maßangaben in mm.

Verwendung: Zum Verschließen der Gewindebohrung in HSK-Werkzeugschäften, wenn kein Kühlmittelrohr zum Einsatz kommt.

Ausführung: Mit Nylok-Einsatz zur Schraubensicherung.

Werkstoff: Rostbeständiger Stahl.



WERKZEUGE MIT FÜHRUNGSLEISTEN

Werkzeuge mit Führungsleisten

Auswahlübersicht Einschneidenreibahlen	478
Bezeichnungsschlüssel	480

WP-Einschneidereibahlen

MN2000	484
MN2003	486
MN2004	488
MN2034	489
MN2023	490
MN2024	491
MN2043	492
MN2044	493
Wendplatten Anschnitte AS AZ DZ EK SZ 	494
Schnittwertempfehlung	504

EasyAdjust-System

Produktübersicht, Handling und Systemübersicht	514
Schneidenverjüngung	516
Auswahlübersicht	517
HX-Wendplatten für EA-System	518
TEC-Wendplatten für EA-System	520
Zubehör	522
Schnittwertempfehlung	524







Außenbearbeitungswerkzeuge

Produktübersicht, Handling und Systemübersicht	538
TEC-Wendeschneidplatten	540
Wendeschneidplatten	542
Zubehör	544
Schnittwertempfehlung	546

Technischer Anhang

Handhabungshinweise	737
---------------------------	-----

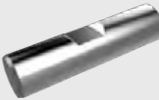
Auswahlübersicht – Einschneidenreibahlen

Maschinen- konzept		Art der Kühlmittelzufuhr		Bohrungsart		Anzahl Schneiden	Schaffform
							
Einschneiden- reibahlen	Bohrmaschinen		✓	✓		1	 Morsekonusschaft
Einschneidenreibahlen	Drehautomaten (mit Pendelhalter)	✓		✓		1	 Zylinderschaft mit Spannfläche
		✓			✓	1	
		✓			✓	1	
Einschneidenreibahlen	Bearbeitungs- zentren	✓		✓		1	 Zylinderschaft mit NC-Spannfläche
		✓			✓	1	
		✓		✓		1	 Zylinderschaft glatt
		✓			✓	1	

Anschnitte für MAPAL Wendeschneidplatten

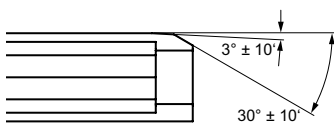

Anschnitt AS

Anschnitt geeignet für alle Materialien, hohe Oberflächengüte auch bei hohen Schnittgeschwindigkeiten. Anschnittlänge 1,3 mm.

Max. Schnitttiefe: 0,25 mm
Spanwinkel: 0°, 6°, 12°

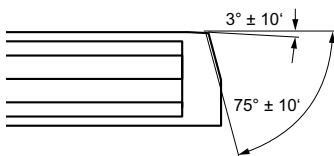

Anschnitt AZ

Für hohe Schnittgeschwindigkeiten; besonders für die Aluminiumbearbeitung geeignet.



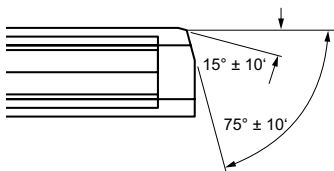



Max. Schnitttiefe: 0,5 mm
Spanwinkel: 0°, 6°, 12°

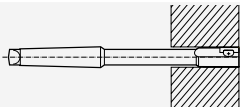
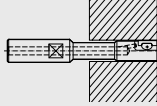

Anschnitt DZ

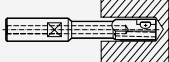
Speziell für kurzspanende Materialien (GG) und große Schnitttiefen. Der Anschnittwinkel der Schlichtschneide von 15° erhöht geringfügig die Radialkräfte, daher auch für dünnwandige Werkstücke geeignet.

Max. Schnitttiefe: 0,15 mm
Spanwinkel: 0°, 6°, 12°

Werkzeug	Schneide		Seite	Baureihe
Baureihe	Bezeichnung			
MN2000	WP-Reibahle 		484	MN2000 Ausführung mit MK-Schaft 
MN2003	WP-Reibahle 		486	MN2003 Kurze Ausführung mit Innenkühlung 
MN2004			488	MN2004 Kurze Ausführung 
MN2034 (Kurzform)			489	MN2034 Extrakurze Ausführung 
MN2023	WP-NC-Reibahle 		490	MN2023 NC-Bauform 
MN2024			491	MN2024 NC-Bauform 
MN2043			492	MN2043 NC-Bauform 
MN2044			493	MN2044 NC-Bauform 

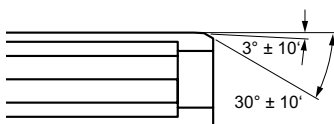
**Anschnitt EK**

Nur dann einsetzen, wenn geringe Anschnittlänge von 0,6 mm gefordert wird, für alle Werkstoffe, max. Vorschub von 0,2 mm/U nicht überschreiten.

Max. Schnitttiefe: 0,15 mm
Spanwinkel: 0°, 6°, 12°

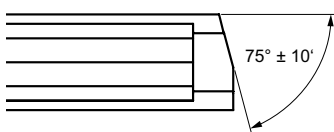
**Anschnitt SZ**

Speziell für Aluminiumgusslegierungen, bei kleinen Vorschüben gute Oberfläche. Stichmaße werden genau eingehalten. Der Anschnittwinkel der Hauptschneide von 75° verringert die Radialkräfte, daher besonders für dünnwandige Werkstücke geeignet.

Max. Schnitttiefe: 1,0 mm
Spanwinkel: 6°, 12°

Bezeichnungsschlüssel

WP-Reibahle

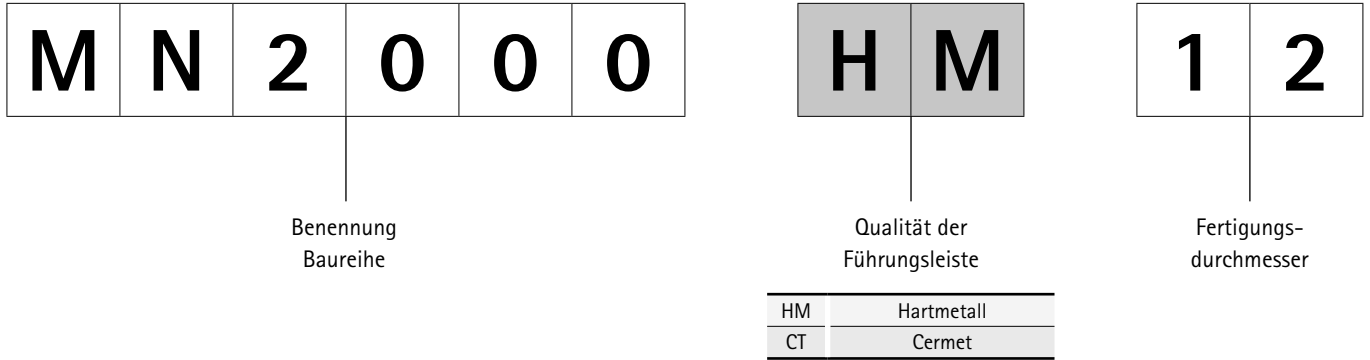

EasyAdjust-System

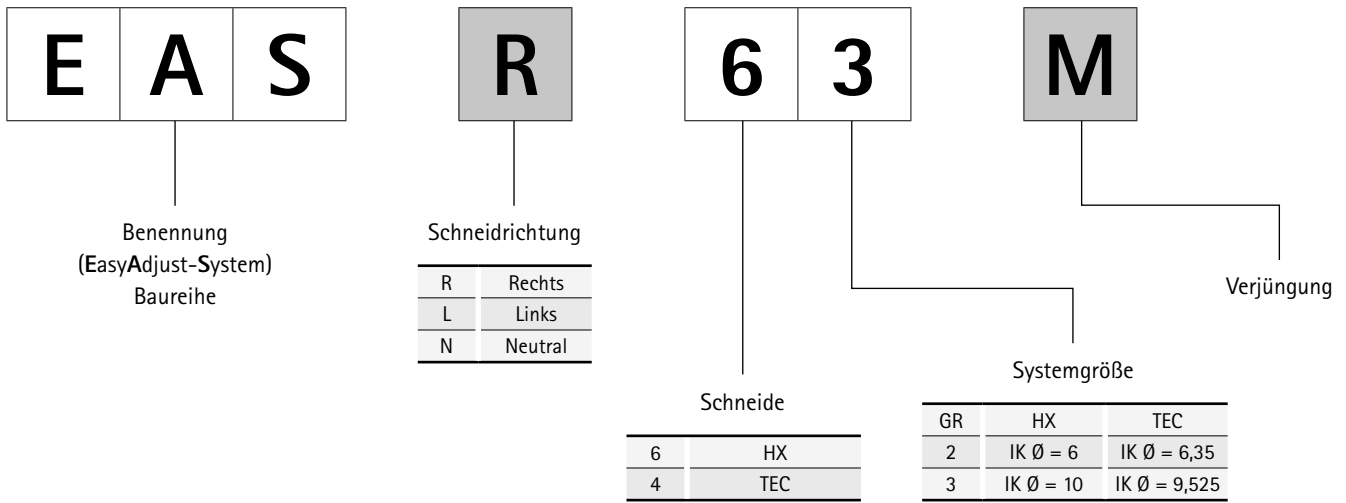

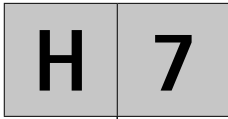

Toleranz IT
oder Abmaße

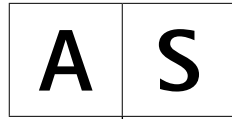

Anschnitt-
bezeichnung

AS	Informationen zur Anwendung auf den Seiten 478/479
AZ	
DZ	
EK	
SZ	

Bezeichnungsschlüssel

Wendeschnidplatten



Größe
81 | 90 | 91 | 92 | 93
Die Größe passend zur Ausführung der Reibahle wählen. Zuordnung siehe Produkttabellen.

Nur bei Ausführungen mit F-Fase angeben.

A S

9 2

R F 0

Anschnittform
AS = 3°/30° Länge 1,3 mm
AZ = 3°/75° Länge 1,3 mm
DZ = 15°/75° Länge 0,55 mm
EK = 3°/30° Länge 0,6 mm
SZ = 0°/75° Länge 0,55 mm

Schneidsinn
R = Rechtsschneidend
L = Linksschneidend

Größe des Spanwinkels
0 = 0°
6 = 6°
2 = 12°

HX-Wendeschnidplatten



H X

1

3

Anschnitt
8 = R 0,8

8

Sechskantform
Hexagonal

Spanformgeometrie
(Spanwinkel)
1 = Hochpositiv
2 = Positiv

Wendeschnidplattengröße
2 = Inkreis ø 6 mm
3 = Inkreis ø 10 mm

TEC-Wendeschnidplatten



T E C

2

0 8

F 0 1

Plattenform
(Tetragonal)

Wendeschnidplattengröße
2 = Inkreis-Ø: 6,35
3 = Inkreis-Ø: 9,525

Anschnittform
04 = R = 0,4
08 = R = 0,8
AS = 3°/30° Länge 1,3
EK = 3°/30° Länge 0,6
DZ = 15°/75° Länge 0,55

Schneidkantenausführung
F01 = Scharfkantig
E02 = Verrundet
S35 = Negative Fase und verrundet

H	U	6	1	5
---	---	---	---	---

Schneidstoffqualität
z. B.: HU = Hartmetall, unbeschichtet

R	L
---	---

Schneidsinn
RL = Rechts- und linksschneidend

C	U	1	3	4
---	---	---	---	---

Schneidstoffqualität
z. B.: HU = Hartmetall, unbeschichtet

Optional:
F-Fase

R

Schneidrichtung
R = Rechtsschneidend
L = Linksschneidend
N = Rechts-/linksschneidend (Neutral)

F

Spanformstufe
1. Stelle (Lage)
0 = Ohne Ausprägung
1 = Parallel positiv

1	G
---	---

Spanformstufe 2. Stelle (Spanwinkel)
A = 0° N = 12°
G = 6° U = 18°
J = 8°

F

Nur bei bestückten Schneiden
F = Ganze Spanfläche auf einer Seite (Full-Fase)

-	H	U	6	1	2
---	---	---	---	---	---

Schneidstoffqualität
(Beispiel)



WP-Einschneidenreibahle MN2000

Ausführung mit MK-Schaft

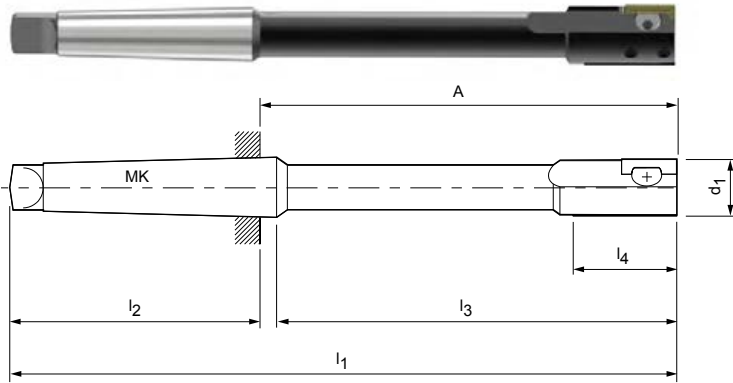

Baumaße							Zubehör					
d ₁ *	l ₁	l ₂	l ₃	l ₄	MK	A	Wende- schneid- platten- größe	Spannen		Justieren		
								Torx-Schraube/ Gewindespindel	Spannplatte	Gewindestift MN 620	Justierkeil MN 619	
Bestell-Nr. (Größe)												
5,00 - 5,29	126**	62	60,5	15	1	64	(SP) 81	Torx-Schraube	10036776 (M1,6x3,9)	30026285 (GR - 1YN)	10036736 (M2x1,8)	30026239 (GR - 06)
5,30 - 5,49	126**	62	60,5	15	1	64	(SP) 81		10036778 (M1,6x4,4)	30026285 (GR - 1YN)	10036737 (M2x2)	30026239 (GR - 06)
5,50 - 6,19	126**	62	60,5	15	1	64	(SP) 81		10036780 (M2x4)	30026286 (GR - 1X)	10036737 (M2x2)	30026260 (GR - 07)
6,20 - 6,90	126**	62	60,5	15	1	64	(SP) 81		10036781 (M2x5)	30026286 (GR - 1X)	10036738 (M2x2,5)	30026260 (GR - 07)
6,91 - 7,49	136**	62	70,5	15	1	74	90		10036783 (M2,5x4,8)	30026287 (GR - 1W)	10036730 (M2,5x2,2)	30026261 (GR - 08)
7,50 - 7,79	136**	62	70,5	15	1	74	90		10036784 (M2,5x5,2)	30026287 (GR - 1W)	10036731 (M2,5x2,5)	30026262 (GR - 09)
7,80 - 7,99	155	62	89,5	30	1	93	90		10036711 (M3LH/RHx5)	30026288 (GR - 0F)	10036743 (M3x2,5)	30026238 (GR - 0)
8,00 - 8,79	155	62	89,5	30	1	93	90	10036711 (M3LH/RHx5)	30026288 (GR - 0F)	10036743 (M3x2,5)	30026238 (GR - 0)	
8,80 - 9,29	160	62	94,5	30	1	98	90	10036722 (M3LH/RHx6)	30026289 (GR - 0N)	10036744 (M3x3)	30026238 (GR - 0)	
9,30 - 9,79	170	62	104,5	30	1	108	91	10036722 (M3LH/RHx6)	30026292 (GR - 1N)	10036744 (M3x3)	30026238 (GR - 0)	
9,80 - 11,29	170	62	104,5	30	1	108	91	10036722 (M3LH/RHx6)	30026292 (GR - 1N)	10036744 (M3x3)	30026263 (GR - 1)	
11,30 - 11,79	170	62	104,5	30	1	108	92	10036724 (M4x0,5LH/RHx6,5)	30026294 (GR - 2F)	10036751 (M4x3)	30026266 (GR - 2)	
11,80 - 12,29	170	62	104,5	30	1	108	92	10036724 (M4x0,5LH/RHx6,5)	30026294 (GR - 2F)	10036751 (M4x3)	30026266 (GR - 2)	
12,30 - 13,29	180	62	114,5	30	1	118	92	10036724 (M4x0,5LH/RHx6,5)	30026294 (GR - 2F)	10036752 (M4x4)	30026266 (GR - 2)	
13,30 - 14,29	180	62	114,5	30	1	118	92	10036725 (M4x0,5LH/RHx9)	30026296 (GR - 2N)	10036753 (M4x5)	30026266 (GR - 2)	
14,30 - 15,29	180	62	114,5	30	1	118	92	10036725 (M4x0,5LH/RHx9)	30026296 (GR - 2N)	10036753 (M4x5)	30026266 (GR - 2)	
15,30 - 16,29	200	75	120	30	2	125	92	10036725 (M4x0,5LH/RHx9)	30026296 (GR - 2N)	10036753 (M4x5)	30026266 (GR - 2)	
16,30 - 18,29	210	75	130	30	2	135	92	10036725 (M4x0,5LH/RHx9)	30026296 (GR - 2N)	10036753 (M4x5)	30026266 (GR - 2)	
18,30 - 20,29	220	75	140	30	2	145	92	10036725 (M4x0,5LH/RHx9)	30026296 (GR - 2N)	10036755 (M4x8)	30026266 (GR - 2)	

Bestellbeispiel (siehe S. 480): MN2000 HM 11,8 H7 AS

Maßangaben in mm.

Weitere Abmessungen auf Anfrage erhältlich.

SP = Schneidplatte, nicht wendbar.

Einstellhinweise und Einbau der Zubehörteile siehe Kapitel "Technischer Anhang".

* Werte geben nicht den Verstellbereich an, sondern die Baugrößen zu verschiedenen Durchmessern (verstellbar nur innerhalb eines Toleranzfeldes).

** Mit 2,5 mm langem Zentrierzapfen bei d₁ kleiner 7,8 mm.

Bei Bestellung gewünschte Führungsleistenqualität (HM, Cermet) angeben.

Ohne Angabe werden die Führungsleisten in HM-Qualität ausgeführt.

Werkzeuge mit Führungsleisten in PKD-Qualität ab Ø 8 mm erhältlich.

Reparaturen aus technischen Gründen ab Ø 8,00 möglich

Preis und Lieferzeit für Werkzeuge mit Führungsleisten in PKD-Qualität auf Anfrage.

Hierzu passende Wende-schneidplatten ab Seite 494.

WP-Einschneidenreibahle MN2003

Kurze Ausführung mit Innenkühlung

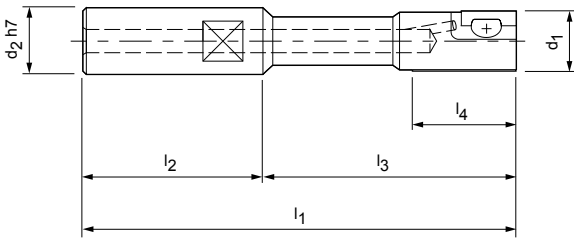

Baumaße						Wende- schneid- platten- größe	Zubehör				
d ₁ *	d ₂ H7	l ₁	l ₂	l ₃	l ₄		Spannen		Justieren		
							Torx-Schraube/ Gewindespindel	Spannplatte	Gewindestift MN 620	Justierkeil MN 619	
							Bestell-Nr. (Größe)				
5,00 - 5,29	10	90**	30	60	15	(SP) 81	Torx-Schraube	10036776 (M1,6x3,9)	30026285 (GR - 1YN)	10036736 (M2x1,8)	30026239 (GR - 06)
5,30 - 5,49	10	90**	30	60	15	(SP) 81		10036778 (M1,6x4,4)	30026285 (GR - 1YN)	10036737 (M2x2)	30026239 (GR - 06)
5,50 - 6,19	10	90**	30	60	15	(SP) 81		10036780 (M2x4)	30026286 (GR - 1X)	10036737 (M2x2)	30026260 (GR - 07)
6,20 - 6,90	10	90**	30	60	15	(SP) 81		10036781 (M2x5)	30026286 (GR - 1X)	10036738 (M2x2,5)	30026260 (GR - 07)
6,91 - 7,49	10	100**	30	70	15	90		10036783 (M2,5x4,8)	30026287 (GR - 1W)	10036730 (M2,5x2,2)	30026261 (GR - 08)
7,50 - 7,79	10	100**	30	70	15	90		10036784 (M2,5x5,2)	30026287 (GR - 1W)	10036731 (M2,5x2,5)	30026262 (GR - 09)
7,80 - 8,29	16	120	45	75	30	90		10036711 (M3LH/RHx5)	30026288 (GR - 0F)	10036743 (M3x2,5)	30026238 (GR - 0)
8,30 - 8,79	16	120	45	75	30	90		10036711 (M3LH/RHx5)	30026288 (GR - 0F)	10036744 (M3x3)	30026238 (GR - 0)
8,80 - 9,29	16	120	45	75	30	90		10036722 (M3LH/RHx6)	30026289 (GR - 0N)	10036744 (M3x3)	30026238 (GR - 0)
9,30 - 9,79	16	120	45	75	30	91		10036722 (M3LH/RHx6)	30026292 (GR - 1N)	10036744 (M3x3)	30026238 (GR - 0)
9,80 - 11,29	16	120	45	75	30	91		10036722 (M3LH/RHx6)	30026292 (GR - 1N)	10036744 (M3x3)	30026263 (GR - 1)
11,30 - 11,79	16	120	45	75	30	92		10036724 (M4x0,5LH/RHx6,5)	30026294 (GR - 2F)	10036751 (M4x3)	30026266 (GR - 2)
11,80 - 12,29	16	120	45	75	30	92		10036724 (M4x0,5LH/RHx6,5)	30026294 (GR - 2F)	10036751 (M4x3)	30026266 (GR - 2)
12,30 - 13,29	16	120	45	75	30	92		10036724 (M4x0,5LH/RHx6,5)	30026294 (GR - 2F)	10036752 (M4x4)	30026266 (GR - 2)
13,30 - 14,29	16	120	45	75	30	92		10036725 (M4x0,5LH/RHx9)	30026296 (GR - 2N)	10036753 (M4x8)	30026266 (GR - 2)
14,30 - 18,29	20	130	55	75	30	92		10036725 (M4x0,5LH/RHx9)	30026296 (GR - 2N)	10036753 (M4x8)	30026266 (GR - 2)
18,30 - 19,79	20	130	55	75	30	92	10036725 (M4x0,5LH/RHx9)	30026296 (GR - 3N)	10036755 (M6x15)	30026266 (GR - 4)	
19,80 - 20,29	20	150	55	95	30	92	10036725 (M4x0,5LH/RHx9)	30026296 (GR - 3N)	10036755 (M6x15)	30026266 (GR - 4)	
							Gewindespindel MN 618				

WP-Einschneidenreibahle MN2003

Baumaße						Wende- schneid- platten- größe	Zubehör				
d ₁ *	d ₂ H7	l ₁	l ₂	l ₃	l ₄		Spannen		Justieren		
							Torx-Schraube/ Gewindespindel	Spannplatte	Gewindestift MN 620	Justierkeil MN 619	
							Bestell-Nr. (Größe)				
20,30 – 26,29	20	150	55	95	30	92	MN 618	10036725 (M4x0,5LH/RHx9)	30026296 (GR - 2N)	10036755 (M4x8)	30026266 (GR - 2)
26,30 – 30,29	25	160	65	95	30	92		10036725 (M4x0,5LH/RHx9)	30026296 (GR - 2N)	10036755 (M4x8)	30026266 (GR - 2)

Bestellbeispiel (siehe S. 480):

MN2003 HM 20,99 H7 AS

Maßangaben in mm.

Weitere Abmessungen auf Anfrage erhältlich.

SP = Schneidplatte, nicht wendbar.

Einstellhinweise und Einbau der Zubehörteile siehe Kapitel "Technischer Anhang".

* Werte geben nicht den Verstellbereich an, sondern die Baugrößen zu verschiedenen Durchmessern (verstellbar nur innerhalb eines Toleranzfeldes).

** Mit 2,5 mm langem Zentrierzapfen bei d₁ kleiner 7,8 mm.

Bei Bestellung gewünschte Führungsleistenqualität (HM, Cermet) angeben.

Ohne Angabe werden die Führungsleisten in HM-Qualität ausgeführt.

Werkzeuge mit Führungsleisten in PKD-Qualität ab Ø 8 mm erhältlich.

Reparaturen aus technischen Gründen ab Ø 08.00 möglich.

Preis und Lieferzeit für Werkzeuge mit Führungsleisten in PKD-Qualität auf Anfrage.

Hierzu passende Wendschneidplatten ab Seite 494.

WP-Einschneidenreibahle MN2004

Kurze Ausführung

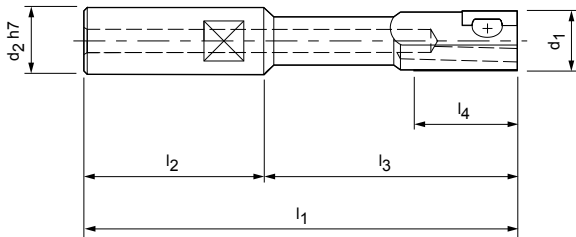

Baumaße						Wendeschneidplattengröße	Zubehör				
d ₁ *	d ₂ H7	l ₁	l ₂	l ₃	l ₄		Spannen		Justieren		
							Torx-Schraube/ Gewindespindel	Spannplatte	Gewindestift MN 620	Justierkeil MN 619	
Bestell-Nr. (Größe)											
5,90 - 6,29	10	90**	30	60	15	(SP) 81	Torx-Schraube	10036776 (M1,6x3,9)	30026285 (GR - 1YN)	10036737 (M2x2)	30026239 (GR - 06)
6,30 - 6,90	10	90**	30	60	15	(SP) 81		10036778 (M1,6x4,4)	30026285 (GR - 1YN)	10036738 (M2x2,5)	30026239 (GR - 06)
6,91 - 7,29	10	100**	30	70	15	(SP) 81		10036778 (M1,6x4,4)	30026285 (GR - 1YN)	10036738 (M2x2,5)	30026239 (GR - 06)
7,30 - 7,79	10	100**	30	70	15	(SP) 81		10036781 (M2x5)	30026286 (GR - 1X)	10036739 (M2x3)	30026260 (GR - 07)
7,80 - 8,29	16	120**	45	75	15	(SP) 81		10036781 (M2x5)	30026286 (GR - 1X)	10036739 (M2x3)	30026260 (GR - 07)
8,30 - 9,79	16	120	45	75	15	90		10036784 (M2,5x5,2)	30026287 (GR - 1W)	10036732 (M2,5x3)	30026262 (GR - 09)
9,80 - 10,29	16	120	45	75	15	90		10036784 (M2,5x5,2)	30026287 (GR - 1W)	10036733 (M2,5x4)	30026262 (GR - 09)
10,30 - 11,29	16	120	45	75	30	90		10036722 (M3LH/RHx6)	30026289 (GR - 0N)	10036744 (M3x3)	30026263 (GR - 1)
11,30 - 12,29	16	120	45	75	30	90		10036722 (M3LH/RHx6)	30026289 (GR - 0N)	10036745 (M3x4)	30026263 (GR - 1)
12,30 - 14,29	16	120	45	75	30	91		10036722 (M3LH/RHx6)	30026292 (GR - 1N)	10036745 (M3x4)	30026263 (GR - 1)
14,30 - 16,29	20	130	55	75	30	91	10036722 (M3LH/RHx6)	30026292 (GR - 1N)	10036747 (M3x6)	30026263 (GR - 1)	
16,30 - 17,29	20	130	55	75	30	92	10036725 (M4x0,5LH/RHx9)	30026296 (GR - 2N)	10036753 (M4x5)	30026266 (GR - 2)	
17,30 - 19,79	20	130	55	75	30	92	10036725 (M4x0,5LH/RHx9)	30026296 (GR - 2N)	10036754 (M4x6)	30026266 (GR - 2)	
19,80 - 26,29	20	150	55	95	30	92	10036725 (M4x0,5LH/RHx9)	30026296 (GR - 2N)	10036755 (M4x8)	30026266 (GR - 2)	
26,30 - 30,29	25	160	65	95	30	92	10036725 (M4x0,5LH/RHx9)	30026296 (GR - 2N)	10036755 (M4x8)	30026266 (GR - 2)	
							Gewindespindel MN 618				

Bestellbeispiel (siehe S. 480):
MN2004 HM 20,99 H7 AS

Maßangaben in mm.

Weitere Abmessungen auf Anfrage erhältlich.

Einstellhinweise und Einbau der Zubehörteile siehe Kapitel "Technischer Anhang".

* Werte geben nicht den Verstellbereich an, sondern die Baugrößen zu verschiedenen Durchmessern (verstellbar nur innerhalb eines Toleranzfeldes).

** Mit 1 mm langem Zentrierzapfen bei d₁ kleiner 8,3 mm.

Bei Bestellung gewünschte Führungsleistenqualität (HM, Cermet) angeben.

Ohne Angabe werden die Führungsleisten in HM-Qualität ausgeführt.

Werkzeuge mit Führungsleisten in PKD-Qualität ab Ø 8 mm erhältlich.

Reparaturen aus technischen Gründen ab Ø 08.00 möglich.

Preis und Lieferzeit für Werkzeuge mit Führungsleisten in PKD-Qualität auf Anfrage.

Hierzu passende Wendeschneidplatten ab Seite 494.

WP-Einschneidenreibahle MN2034

Extrakurze Ausführung

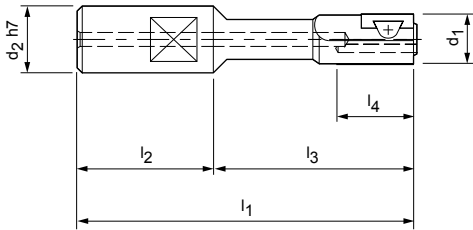

Baumaße						Wendeschneidplattengröße	Zubehör				
d ₁ *	d ₂ H7	l ₁	l ₂	l ₃	l ₄		Spannen		Justieren		
							Torx-Schraube/ Gewindespindel	Spannplatte	Gewindestift MN 620	Justierkeil MN 619	
Bestell-Nr. (Größe)											
5,90 - 6,29	16	85**	27	58	15	(SP) 81	Torx-Schraube	10036776 (M1,6x3,9)	30026285 (GR - 1YN)	10036737 (M2x2)	30026239 (GR - 06)
6,30 - 7,29	16	85**	27	58	15	(SP) 81		10036778 (M1,6x4,4)	30026285 (GR - 1YN)	10036738 (M2x2,5)	30026239 (GR - 06)
7,30 - 8,29	16	85**	27	58	15	(SP) 81		10036781 (M2x5)	30026286 (GR - 1X)	10036739 (M2x3)	30026260 (GR - 07)
8,30 - 9,79	16	85	27	58	15	90		10036784 (M2,5x5,2)	30026287 (GR - 1W)	10036732 (M2,5x3)	30026262 (GR - 09)
9,80 - 10,29	16	85	27	58	15	90		10036784 (M2,5x5,2)	30026287 (GR - 1W)	10036733 (M2,5x4)	30026262 (GR - 09)
10,30 - 11,29	16	85	27	58	30	90	Gewindespindel MN 618	10036722 (M3LH/RHx6)	30026289 (GR - 0N)	10036744 (M3x3)	30026263 (GR - 1)
11,30 - 12,29	16	85	27	58	30	90		10036722 (M3LH/RHx6)	30026289 (GR - 0N)	10036745 (M3x4)	30026263 (GR - 1)
12,30 - 14,29	16	85	27	58	30	91		10036722 (M3LH/RHx6)	30026292 (GR - 1N)	10036745 (M3x4)	30026263 (GR - 1)
14,30 - 16,29	16	85	27	58	30	91		10036722 (M3LH/RHx6)	30026292 (GR - 1N)	10036747 (M3x6)	30026263 (GR - 1)
16,30 - 17,29	16	85	27	58	30	92		10036725 (M4x0,5LH/RHx9)	30026296 (GR - 2N)	10036753 (M4x5)	30026266 (GR - 2)
17,30 - 19,79	16	85	27	58	30	92		10036725 (M4x0,5LH/RHx9)	30026296 (GR - 2N)	10036754 (M4x6)	30026266 (GR - 2)
19,80 - 20,29	16	85	27	58	30	92		10036725 (M4x0,5LH/RHx9)	30026296 (GR - 2N)	10036755 (M4x8)	30026266 (GR - 2)
20,30 - 26,30	20	90	30	60	30	92		10036725 (M4x0,5LH/RHx9)	30026296 (GR - 2N)	10036755 (M4x8)	30026266 (GR - 2)
26,30 - 30,29	25	90	30	60	30	92		10036725 (M4x0,5LH/RHx9)	30026296 (GR - 2N)	10036755 (M4x8)	30026266 (GR - 2)

Bestellbeispiel (siehe S. 480):
MN2034 HM 20,99 H7 AS

Maßangaben in mm.

Weitere Abmessungen auf Anfrage erhältlich.

SP = Schneidplatte, nicht wendbar.

Einstellhinweise und Einbau der Zubehörteile siehe Kapitel "Technischer Anhang".

* Werte geben nicht den Verstellbereich an, sondern die Baugrößen zu verschiedenen Durchmessern (verstellbar nur innerhalb eines Toleranzfeldes).

** Mit 1 mm langem Zentrierzapfen bei d₁ kleiner 8,3 mm.

Bei Bestellung gewünschte Führungsleistenqualität (HM, Cermet) angeben.

Ohne Angabe werden die Führungsleisten in HM-Qualität ausgeführt.

Werkzeuge mit Führungsleisten in PKD-Qualität ab Ø 8 mm erhältlich.

Reparaturen aus technischen Gründen ab Ø 08.00 möglich.

Preis und Lieferzeit für Werkzeuge mit Führungsleisten in PKD-Qualität auf Anfrage.

Hierzu passende Wendeschneidplatten ab Seite 494.

WP-Einschneidenreibahle MN2023

NC-Bauform

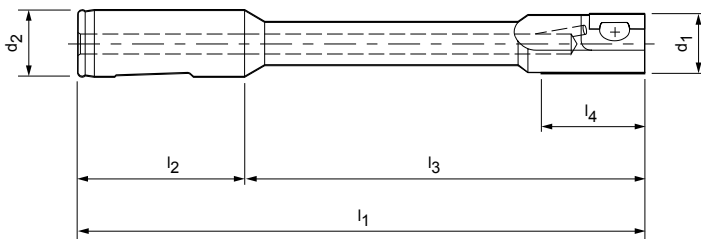

Baumaße						Wendeschneidplattengröße	Zubehör			
d ₁ *	d ₂ (-0,003)	l ₁	l ₂	l ₃	l ₄		Spannen		Justieren	
							Gewindespindel MN 618	Spannplatte	Gewindestift MN 620	Justierkeil MN 619
							Bestell-Nr. (Größe)			
7,80 - 8,29	16	133	48	85	30	90	10036711 (M3LH/RHx5)	30026288 (GR - 0F)	10036743 (M3x2,5)	30026238 (GR - 0)
8,30 - 8,79	16	133	48	85	30	90	10036711 (M3LH/RHx5)	30026288 (GR - 0F)	10036744 (M3x3)	30026238 (GR - 0)
8,80 - 9,29	16	133	48	85	30	90	10036711 (M3LH/RHx5)	30026289 (GR - 0N)	10036744 (M3x3)	30026238 (GR - 0)
9,30 - 11,29	16	133	48	85	30	91	10036722 (M3LH/RHx6)	30026292 (GR - 1N)	10036744 (M3x3)	30026263 (GR - 1)
11,30 - 11,79	16	133	48	85	30	92	10036724 (M4x0,5LH/RHx6,5)	30026294 (GR - 2F)	10036751 (M4x3)	30026266 (GR - 2)
11,80 - 12,29	16	168	48	120	30	92	10036724 (M4x0,5LH/RHx6,5)	30026294 (GR - 2F)	10036751 (M4x3)	30026266 (GR - 2)
12,30 - 13,29	16	168	48	120	30	92	10036724 (M4x0,5LH/RHx6,5)	30026294 (GR - 2F)	10036752 (M4x4)	30026266 (GR - 2)
13,30 - 14,29	16	168	48	120	30	92	10036725 (M4x0,5LH/RHx9)	30026296 (GR - 2N)	10036753 (M4x5)	30026266 (GR - 2)
14,30 - 15,79	20	170	50	120	30	92	10036725 (M4x0,5LH/RHx9)	30026296 (GR - 2N)	10036753 (M4x5)	30026266 (GR - 2)
15,80 - 17,79	20	170	50	120	30	92	10036725 (M4x0,5LH/RHx9)	30026296 (GR - 2N)	10036753 (M4x5)	30026266 (GR - 2)
17,80 - 18,29	20	170	50	120	30	92	10036725 (M4x0,5LH/RHx9)	30026296 (GR - 2N)	10036753 (M4x5)	30026266 (GR - 2)
18,30 - 19,79	20	170	50	120	30	92	10036725 (M4x0,5LH/RHx9)	30026296 (GR - 2N)	10036754 (M4x6)	30026266 (GR - 2)
19,80 - 24,79	20	170	50	120	30	92	10036725 (M4x0,5LH/RHx9)	30026296 (GR - 2N)	10036755 (M4x8)	30026266 (GR - 2)
24,80 - 29,29	20	170	50	120	30	93	10036725 (M4x0,5LH/RHx9)	30026298 (GR - 3N)	10036761 (M6x10)	30026279 (GR - 4)
28,80 - 30,79	20	170	50	120	30	93	10036725 (M4x0,5LH/RHx9)	30026298 (GR - 3N)	10036762 (M6x12)	30026279 (GR - 4)

Bestellbeispiel (siehe S. 480):

MN2023 HM 20,99 H7 AS

Maßangaben in mm.

Weitere Abmessungen auf Anfrage erhältlich.

Einstellhinweise und Einbau der Zubehörteile siehe Kapitel "Technischer Anhang".

* Werte geben nicht den Verstellbereich an, sondern die Baugrößen zu verschiedenen Durchmessern (verstellbar nur innerhalb eines Toleranzfeldes).

Bei Bestellung gewünschte Führungsleistenqualität (HM, Cermet) angeben.

Ohne Angabe werden die Führungsleisten in HM-Qualität ausgeführt.

Werkzeuge mit Führungsleisten in PKD-Qualität ab Ø 8 mm erhältlich.

Reparaturen aus technischen Gründen ab Ø 08.00 möglich.

Preis und Lieferzeit für Werkzeuge mit Führungsleisten in PKD-Qualität auf Anfrage.

Hierzu passende Wendeschneidplatten ab Seite 494.

WP-Einschneidenreibahle MN2024

NC-Bauform

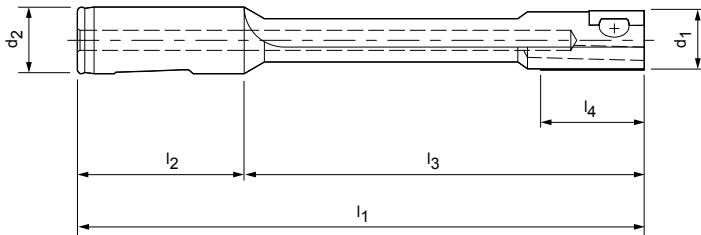

Baumaße						Wendeschneidplattengröße	Zubehör			
d ₁ *	d ₂ (-0,003)	l ₁	l ₂	l ₃	l ₄		Spannen		Justieren	
							Gewindespindel MN 618	Spannplatte	Gewindestift MN 620	Justierkeil MN 619
							Bestell-Nr. (Größe)			
7,80 - 8,29	16	133	48	85	30	90	10036711 (M3LH/RHx5)	30026291 (GR - OZ)	10036743 (M3x2,5)	30026238 (GR - 0)
8,30 - 8,79	16	133	48	85	30	90	10036711 (M3LH/RHx5)	30026291 (GR - OZ)	10036744 (M3x3)	30026238 (GR - 0)
8,80 - 9,29	16	133	48	85	30	90	10036711 (M3LH/RHx5)	30026291 (GR - OZ)	10036744 (M3x3)	30026238 (GR - 0)
9,30 - 11,29	16	133	48	85	30	90	10036722 (M3LH/RHx6)	30026289 (GR - ON)	10036744 (M3x3)	30026263 (GR - 1)
11,30 - 11,79	16	133	48	85	30	90	10036722 (M3LH/RHx6)	30026289 (GR - ON)	10036745 (M3x4)	30026263 (GR - 1)
11,80 - 12,29	16	168	48	120	30	90	10036722 (M3LH/RHx6)	30026289 (GR - ON)	10036745 (M3x4)	30026263 (GR - 1)
12,30 - 14,29	16	168	48	120	30	91	10036722 (M3LH/RHx6)	30026292 (GR - 1N)	10036745 (M3x4)	30026263 (GR - 1)
14,30 - 16,29	20	170	50	120	30	91	10036722 (M3LH/RHx6)	30026292 (GR - 1N)	10036747 (M3x6)	30026263 (GR - 1)
16,30 - 17,29	20	170	50	120	30	92	10036725 (M4x0,5LH/RHx9)	30026296 (GR - 2N)	10036753 (M4x5)	30026266 (GR - 2)
17,30 - 19,79	20	170	50	120	30	92	10036725 (M4x0,5LH/RHx9)	30026296 (GR - 2N)	10036754 (M4x6)	30026266 (GR - 2)
19,80 - 20,79	20	170	50	120	30	92	10036725 (M4x0,5LH/RHx9)	30026296 (GR - 2N)	10036755 (M4x8)	30026266 (GR - 2)

Bestellbeispiel (siehe S. 480):

MN2024 HM 11,99 H7 AS

Maßangaben in mm.

Weitere Abmessungen auf Anfrage erhältlich.

Einstellhinweise und Einbau der Zubehörteile siehe Kapitel "Technischer Anhang".

* Werte geben nicht den Verstellbereich an, sondern die Baugrößen zu verschiedenen Durchmessern (verstellbar nur innerhalb eines Toleranzfeldes).

Bei Bestellung gewünschte Führungsleistenqualität (HM, Cermet) angeben.

Ohne Angabe werden die Führungsleisten in HM-Qualität ausgeführt.

Werkzeuge mit Führungsleisten in PKD-Qualität ab Ø 8 mm erhältlich.

Reparaturen aus technischen Gründen ab Ø 08.00 möglich.

Preis und Lieferzeit für Werkzeuge mit Führungsleisten in PKD-Qualität auf Anfrage.

Hierzu passende Wendeschneidplatten ab Seite 494.

WP-Einschneidenreibahle MN2043

NC-Bauform

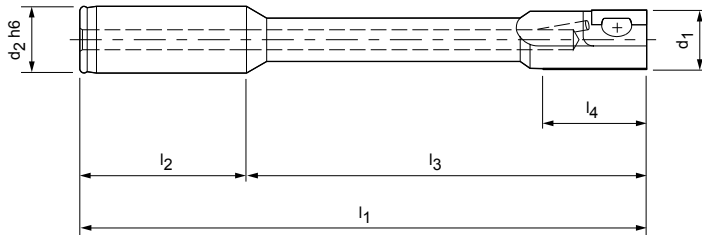

Baumaße						Wendeschneidplattengröße	Zubehör			
d ₁ *	d ₂ h6	l ₁	l ₂	l ₃	l ₄		Spannen		Justieren	
							Gewindespindel MN 618	Spannplatte	Gewindestift MN 620	Justierkeil MN 619
							Bestell-Nr. (Größe)			
7,80 - 8,29	16	133	48	85	30	90	10036711 (M3LH/RHx5)	30026288 (GR - 0F)	10036743 (M3x2,5)	30026238 (GR - 0)
8,30 - 8,79	16	133	48	85	30	90	10036711 (M3LH/RHx5)	30026288 (GR - 0F)	10036744 (M3x3)	30026238 (GR - 0)
8,80 - 9,29	16	133	48	85	30	90	10036711 (M3LH/RHx5)	30026289 (GR - 0N)	10036744 (M3x3)	30026238 (GR - 0)
9,30 - 11,29	16	133	48	85	30	91	10036722 (M3LH/RHx6)	30026292 (GR - 1N)	10036744 (M3x3)	30026263 (GR - 1)
11,30 - 11,79	16	133	48	85	30	92	10036724 (M4x0,5LH/RHx6,5)	30026294 (GR - 2F)	10036751 (M4x3)	30026266 (GR - 2)
11,80 - 12,29	16	168	48	120	30	92	10036724 (M4x0,5LH/RHx6,5)	30026294 (GR - 2F)	10036751 (M4x3)	30026266 (GR - 2)
12,30 - 13,29	16	168	48	120	30	92	10036724 (M4x0,5LH/RHx6,5)	30026294 (GR - 2F)	10036752 (M4x4)	30026266 (GR - 2)
13,30 - 14,29	16	168	48	120	30	92	10036725 (M4x0,5LH/RHx9)	30026296 (GR - 2N)	10036753 (M4x5)	30026266 (GR - 2)
14,30 - 15,79	20	170	50	120	30	92	10036725 (M4x0,5LH/RHx9)	30026296 (GR - 2N)	10036753 (M4x5)	30026266 (GR - 2)
15,80 - 17,79	20	170	50	120	30	92	10036725 (M4x0,5LH/RHx9)	30026296 (GR - 2N)	10036753 (M4x5)	30026266 (GR - 2)
17,80 - 18,29	20	170	50	120	30	92	10036725 (M4x0,5LH/RHx9)	30026296 (GR - 2N)	10036753 (M4x5)	30026266 (GR - 2)
18,30 - 19,79	20	170	50	120	30	92	10036725 (M4x0,5LH/RHx9)	30026296 (GR - 2N)	10036754 (M4x6)	30026266 (GR - 2)
19,80 - 24,79	20	170	50	120	30	92	10036725 (M4x0,5LH/RHx9)	30026296 (GR - 2N)	10036755 (M4x8)	30026266 (GR - 2)
24,80 - 28,79	20	170	50	120	30	93	10036725 (M4x0,5LH/RHx9)	30026298 (GR - 3N)	10036761 (M6x10)	30026279 (GR - 4)
28,80 - 31,79	20	170	50	120	30	93	10036725 (M4x0,5LH/RHx9)	30026298 (GR - 3N)	10036762 (M6x12)	30026279 (GR - 4)
31,80 - 37,79	20	170	50	120	30	93	10036725 (M4x0,5LH/RHx9)	30026298 (GR - 3N)	10036764 (M6x15)	30026279 (GR - 4)
37,80 - 40,29	25	176	56	120	30	93	10036725 (M4x0,5LH/RHx9)	30026298 (GR - 3N)	10036764 (M6x15)	30026279 (GR - 4)

Bestellbeispiel (siehe S. 480):

MN2043 HM 20,99 H7 AS

Maßangaben in mm.

Weitere Abmessungen auf Anfrage erhältlich.

Einstellhinweise und Einbau der Zubehörteile siehe Kapitel "Technischer Anhang".

* Werte geben nicht den Verstellbereich an, sondern die Baugrößen zu verschiedenen Durchmessern (verstellbar nur innerhalb eines Toleranzfeldes).

Bei Bestellung gewünschte Führungsleistenqualität (HM, Cermet) angeben.

Ohne Angabe werden die Führungsleisten in HM-Qualität ausgeführt.

Werkzeuge mit Führungsleisten in PKD-Qualität ab Ø 8 mm erhältlich.

Reparaturen aus technischen Gründen ab Ø 08.00 möglich.

Preis und Lieferzeit für Werkzeuge mit Führungsleisten in PKD-Qualität auf Anfrage.

Hierzu passende Wendeschneidplatten ab Seite 494.

WP-Einschneidenreibahle MN2044

NC-Bauform

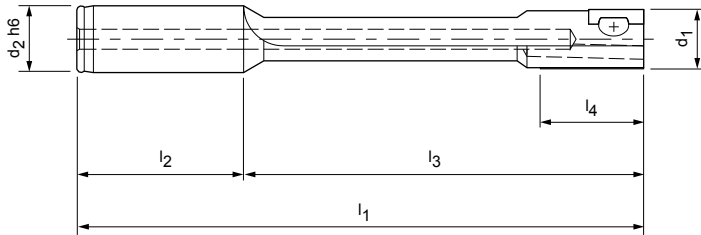

Baumaße						Wendeschneidplattengröße	Zubehör			
d ₁ *	d ₂ h6	l ₁	l ₂	l ₃	l ₄		Spannen		Justieren	
							Gewindespindel MN 618	Spannplatte	Gewindestift MN 620	Justierkeil MN 619
							Bestell-Nr. (Größe)			
7,80 - 8,29	16	133	48	85	30	90	10036711 (M3LH/RHx5)	30026291 (GR - OZ)	10036743 (M3x2,5)	30026238 (GR - 0)
8,30 - 8,79	16	133	48	85	30	90	10036711 (M3LH/RHx5)	30026291 (GR - OZ)	10036744 (M3x3)	30026238 (GR - 0)
8,80 - 9,29	16	133	48	85	30	90	10036711 (M3LH/RHx5)	30026291 (GR - OZ)	10036744 (M3x3)	30026238 (GR - 0)
9,30 - 11,29	16	133	48	85	30	90	10036722 (M3LH/RHx6)	30026289 (GR - ON)	10036744 (M3x3)	30026263 (GR - 1)
11,30 - 11,79	16	133	48	85	30	90	10036722 (M3LH/RHx6)	30026289 (GR - ON)	10036745 (M3x4)	30026263 (GR - 1)
11,80 - 12,29	16	168	48	120	30	90	10036722 (M3LH/RHx6)	30026289 (GR - ON)	10036745 (M3x4)	30026263 (GR - 1)
12,30 - 14,29	16	168	48	120	30	91	10036722 (M3LH/RHx6)	30026292 (GR - 1N)	10036745 (M3x4)	30026263 (GR - 1)
14,30 - 16,29	20	170	50	120	30	91	10036722 (M3LH/RHx6)	30026292 (GR - 1N)	10036747 (M3x6)	30026263 (GR - 1)
16,30 - 17,29	20	170	50	120	30	92	10036725 (M4x0,5LH/RHx9)	30026296 (GR - 2N)	10036753 (M4x5)	30026266 (GR - 2)
17,30 - 19,79	20	170	50	120	30	92	10036725 (M4x0,5LH/RHx9)	30026296 (GR - 2N)	10036754 (M4x6)	30026266 (GR - 2)
19,80 - 20,79	20	170	50	120	30	92	10036725 (M4x0,5LH/RHx9)	30026296 (GR - 2N)	10036755 (M4x8)	30026266 (GR - 2)

Bestellbeispiel (siehe S. 480):

MN2044 HM 11,99 H7 AS

Maßangaben in mm.

Weitere Abmessungen auf Anfrage erhältlich.

Einstellhinweise und Einbau der Zubehörteile siehe Kapitel "Technischer Anhang".

* Werte geben nicht den Verstellbereich an, sondern die Baugrößen zu verschiedenen Durchmessern (verstellbar nur innerhalb eines Toleranzfeldes).

Bei Bestellung gewünschte Führungsleistenqualität (HM, Cermet) angeben.

Ohne Angabe werden die Führungsleisten in HM-Qualität ausgeführt.

Werkzeuge mit Führungsleisten in PKD-Qualität ab Ø 8 mm erhältlich.

Reparaturen aus technischen Gründen ab Ø 08.00 möglich.

Preis und Lieferzeit für Werkzeuge mit Führungsleisten in PKD-Qualität auf Anfrage.

Hierzu passende Wendeschneidplatten ab Seite 494.

Wendeschneidplatten mit AS-Anschnitt

Für Werkzeuge mit Führungsleisten

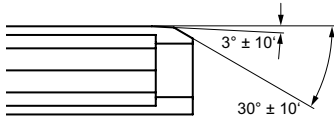

Anschnitt AS

Anschnitt geeignet für alle Materialien, hohe Oberflächengüte auch bei hohen Schnittgeschwindigkeiten. Anschnittlänge 1,3 mm.

Max. Schnitttiefe: 0,25 mm
Spanwinkel: 0°, 6°, 12°

Schneidstoff	Hartmetall								
	MZG*	P			M	K		N	
	1.1 - 1.2	2 - 3 5	P4 P6	1 - 3	1.1	2 - 3	1.1 - 1.2	2.3	2.1 - 2.2
Schneidstoffsorte	HP115	HP425	HP016	HP016	HC418	HP426	HP612	HU615	

Spanwinkel	Baugröße	Spezifikation	Bestell-Nr.							
negativ	81	SP-AS81R0-...								
	90	SP-AS90R0-...								
	91	SP-AS91R0-...								
	92	SP-AS92R0-...								
	93	SP-AS93R0-...								

neutral	81	SP-AS81R0-...								
	90	WP-AS90R0-...								
	91	WP-AS91R0-...								
	92	WP-AS92R0-...								
	93	WP-AS93R0-...								

positiv	81	SP-AS81R6-...	30669442	30669444	31100866	31100866				30669441	
	90	WP-AS90R6-...	30668837	30668839	31100867	31100867				30668836	
	91	WP-AS91R6-...	30668848	30668850	31080268	31080268				30668847	
	92	WP-AS92R6-...	30668858	30668859	30912087	30912087				30668857	
	93	WP-AS93R6-...	30668869	30250310	30915826	30915826				30668868	

hoch positiv	81	SP-AS81R2-...								30685605		30669437
	90	WP-AS90R2-...								30685606		30668833
	91	WP-AS91R2-...								30685607		30668844
	92	WP-AS92R2-...								30685608		30668853
	93	WP-AS93R2-...								30685609		30668863

* MAPAL Zerspanungsgruppen



Hartmetall		
S		H
1 - 2		1.1
HU615		HP016

Cermet	
P	
1 - 3 5	
CP122	

PKD	
N	
1 - 2	
PU620	

PcBN		
K		H
1.1		1.1 - 1.2
FU485		FU801

Bestell-Nr.		

Bestell-Nr.	

Bestell-Nr.	

Bestell-Nr.		

30668838	
30668849	
30357069	
30305745	

	30669189
	30669191
	30669194
	30669197
	30669199

	30669437	
	30668833	
	30668844	
	30668853	
	30668863	

Schnittwertempfehlung siehe Kapitelende.
 Schneiden mit Sonderanschnitt auf Anfrage erhältlich.

Wendeschneidplatten mit AZ-Anschnitt

Für Werkzeuge mit Führungsleisten

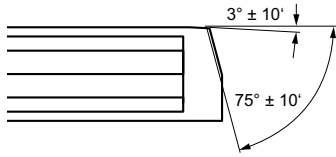

Anschnitt AZ

Für hohe Schnittgeschwindigkeiten, besonders für die Aluminiumbearbeitung geeignet.

Max. Schnitttiefe: 0,5 mm
Spanwinkel: 0°, 6°, 12°

Schneidstoff	Hartmetall								
	MZG*	P			M	K		N	
Schneidstoffsorte	1.1 - 1.2	2 - 3 5	4 6	1 - 3	1.1	2 - 3	1.1 - 1.2	2.3	2.1 - 2.2
	HP115	HP425	HP016	HP016	HC418	HP426	HP612	HU615	

Spanwinkel	Baugröße	Spezifikation	Bestell-Nr.							
negativ	81	SP-AZ81R0-...								
	90	SP-AZ90R0-...								
	91	SP-AZ91R0-...								
	92	SP-AZ92R0-...								
	93	SP-AZ93R0-...								

neutral	81	SP-AZ81R0-...					30685624			
	90	WP-AZ90R0-...					30670062			
	91	WP-AZ91R0-...					30685625			
	92	WP-AZ92R0-...					30664930			
	93	WP-AZ93R0-...					30664935			

positiv	81	SP-AZ81R6-...						30914241		30668876
	90	WP-AZ90R6-...						30914251		30668884
	91	WP-AZ91R6-...						30914261		30668891
	92	WP-AZ92R6-...						30914275		30668903
	93	WP-AZ93R6-...						30914304		30668912

hoch positiv	81	SP-AZ81R2-...							30685639	30668875
	90	WP-AZ90R2-...							30685640	30668881
	91	WP-AZ91R2-...							30685641	30668889
	92	WP-AZ92R2-...							30685642	30668899
	93	WP-AZ93R2-...							30685643	30668908

* MAPAL Zerspanungsgruppen



Hartmetall		
S		H
1 - 2		1.1
HU615		HP016

Cermet	
P	
1 - 3 5	
CP122	

PKD	
N	
1 - 2	
PU620	

PcBN		
K		H
1.1		1.1 - 1.2
FU485		FU801

Bestell-Nr.		

Bestell-Nr.	

Bestell-Nr.	

Bestell-Nr.		

Wendeschneidplatten mit DZ-Anschnitt

Für Werkzeuge mit Führungsleisten

Anschnitt DZ

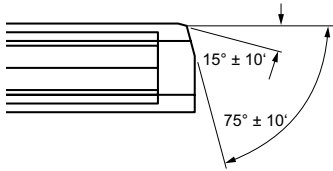

Speziell für kurzspanende Materialien (GG) und große Schnitt-tiefen. Der Anschnittwinkel der Schlichtschneide von 15° erhöht geringfügig die Radialkräfte, daher auch für dünnwandige Werk-stücke geeignet

Max. Schnitttiefe: 0,15 mm
Spanwinkel: 0° , 6° , 12°

Schneidstoff	Hartmetall								
	MZG*	P			M	K		N	
Schneidstoffsorte	1.1 - 1.2	2 - 3 5	4 6	1 - 3	1.1	2 - 3	1.1 - 1.2	2.3	2.1 - 2.2
Schneidstoffsorte	HP115	HP425	HP016	HP016	HC418	HP426	HP612	HU615	

Spanwinkel	Baugröße	Spezifikation	Bestell-Nr.							
negativ	81	SP-DZ81R0-...								
	90	SP-DZ90R0-...								
	91	SP-DZ91R0-...								
	92	SP-DZ92R0-...								
	93	SP-DZ93R0-...								

neutral	81	SP-DZ81R0-...					30685653				
	90	WP-DZ90R0-...					30685654				
	91	WP-DZ91R0-...					30664932				
	92	WP-DZ92R0-...					30685655				
	93	WP-DZ93R0-...					30667699				

positiv	81	SP-DZ81R6-...	30668927	30668928	31090592	31090592		30914351		30668926	
	90	WP-DZ90R6-...	30668936	30668785	31034657	31034657		30914370		30668935	
	91	WP-DZ91R6-...	30668949	30668950	31028496	31028496		30914400		30668947	
	92	WP-DZ92R6-...	30668960	30668961	31100878	31100878		30914435		30668959	
	93	WP-DZ93R6-...	30668969	30668970	31069730	31069730		30914474		30668968	

hoch positiv	81	SP-DZ81R2-...								30685663		30668923
	90	WP-DZ90R2-...								30685664		30668933
	91	WP-DZ91R2-...								30685665		30668942
	92	WP-DZ92R2-...								30685666		30668956
	93	WP-DZ93R2-...								30685667		30668965

* MAPAL Zerspanungsgruppen



Hartmetall	
S	H
1 - 2	1.1
HU615	HP016

Cermet	
P	
1 - 3 5	
CP122	

PKD	
N	
1 - 2	
PU620	

PcBN	
K	H
1.1	1.1 - 1.2
FU485	FU801

Bestell-Nr.	

Bestell-Nr.	

Bestell-Nr.	

Bestell-Nr.	
30262157	30011418
30490660	30020729
30174899	30669469
30502436	30669472

	31090592
	31034657
	31028496
	31100878
	31069730

	30773222
	30668948
	30314334
	30895254

	30669224
	30669464
	30669467
	30669471
	30669473

	30668923
	30668933
	30668942
	30668956
	30668965

Wendeschnidplatten mit EK-Anschnitt

Für Werkzeuge mit Führungsleisten

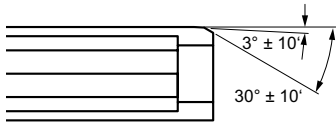

Anschnitt EK

Nur dann einsetzen, wenn geringe Anschnittlänge von 0,6 mm gefordert wird, für alle Werkstoffe; max. Vorschub von 0,2 mm/U nicht überschreiten.

Max. Schnitttiefe: 0,15 mm
Spanwinkel: 0°, 6°, 12°

Schneidstoff	Hartmetall								
	MZG*	P			M	K	N		
Schneidstoffsorte	1.1 - 1.2	2 - 3 5	4 6	1 - 3	1.1	2 - 3	1.1 - 1.2	2.3	2.1 - 2.2
	HP115	HP425	HP016	HP016	HC418	HP426	HP612	HU615	

Spanwinkel	Größe	Spezifikation	Bestell-Nr.							
negativ	181	SP-EK181R0-...								
	150	SP-EK150R0-...								
	151	SP-EK151R0-...								
	152	SP-EK152R0-...								
	153	SP-EK153R0-...								

neutral	181	SP-EK181R0-...								
	150	WP-EK150R0-...								
	151	WP-EK151R0-...								
	152	WP-EK152R0-...								
	153	WP-EK153R0-...								

positiv	181	SP-EK181R6-...	30681706	30681707	31100872	31100872				30681705
	150	WP-EK150R6-...	30668978	30668979	31100873	31100873				30668977
	151	WP-EK151R6-...	30668987	30389077	31049120	31049120				30668986
	152	WP-EK152R6-...	30668999	30669000	30990556	30990556				30668998
	153	WP-EK153R6-...	30669009	30669010	31100874	31100874				30669008

hoch positiv	181	SP-EK181R2-...								30685689	30681702
	150	WP-EK150R2-...								30685690	30668974
	151	WP-EK151R2-...								30685691	30668983
	152	WP-EK152R2-...								30685692	30668993
	153	WP-EK153R2-...								30685693	30669006

* MAPAL Zerspanungsgruppen



Hartmetall		
S		H
1 - 2		1.1
HU615		HP016

Cermet	
P	
1 - 3 5	
CP122	

PKD	
N	
1 - 2	
PU620	

PcBN		
K		H
		1.1 - 1.2
FU485		FU801

Bestell-Nr.		

Bestell-Nr.	

Bestell-Nr.	

Bestell-Nr.		

30685694	
30685695	
30313884	
30543106	

	30681710
	30669474
	30669475
	30669477
	30669479

	30681702	
	30668974	
	30668983	
	30668993	
	30669006	

Schnittwertempfehlung siehe Kapitelende.
 Schneiden mit Sonderanschnitt auf Anfrage erhältlich.

Wendeschneidplatten mit SZ-Anschnitt

Für Werkzeuge mit Führungsleisten

Anschnitt SZ

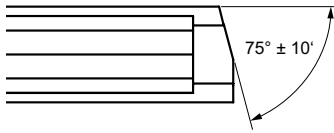

Speziell für Aluminiumgusslegierungen, bei kleinen Vorschüben sehr gute Oberfläche. Stichmaße werden genau eingehalten. Der Anschnittwinkel der Hauptschneide von 75° verringert die Radialkräfte, daher besonders für dünnwandige Werkstücke geeignet.

Max. Schnitttiefe: 1,00 mm
Spanwinkel: 6°, 12°

Schneidstoff	Hartmetall								
	MZG*	P			M	K		N	
Schneidstoffsorte	1.1 - 1.2	2 - 3 5	4 6	1 - 3	1.1	2 - 3	1.1 - 1.2	2.3	2.1 - 2.2
	HP115	HP425	HP016	HP016	HC418	HP426	HP612	HU615	

Spanwinkel	Baugröße	Spezifikation	Bestell-Nr.							
negativ	81	SP-SZ81R0-...								
	90	SP-SZ90R0-...								
	91	SP-SZ91R0-...								
	92	SP-SZ92R0-...								
	93	SP-SZ93R0-...								

neutral	81	SP-SZ81R0-...								
	90	WP-SZ90R0-...								
	91	WP-SZ91R0-...								
	92	WP-SZ92R0-...								
	93	WP-SZ93R0-...								

positiv	81	SP-SZ81R6-...							31306727	30669514
	90	WP-SZ90R6-...							31306729	30669523
	91	WP-SZ91R6-...							31306730	30669534
	92	WP-SZ92R6-...							30690795	30669541
	93	WP-SZ93R6-...							31306732	30669549

hoch positiv	81	SP-SZ81R2-...								30669511
	90	WP-SZ90R2-...								30669520
	91	WP-SZ91R2-...								30669531
	92	WP-SZ92R2-...								30669538
	93	WP-SZ93R2-...								30669546

* MAPAL Zerspanungsgruppen

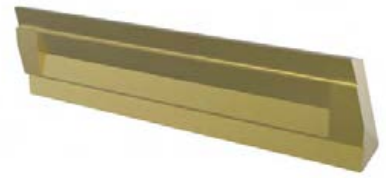

Hartmetall		
S		H
1 - 2		1.1
HU615		HP016

Cermet	
P	
1 - 3 5	
CP122	

PKD	
N	
1 - 2	
PU620	

PcBN		
K		H
1.1 - 1.2		
FU485		FU801

Bestell-Nr.		

Bestell-Nr.	

Bestell-Nr.	

Bestell-Nr.		

	30669493
	30669494
	30669495
	30669498
	30669502

Schnittwertempfehlung für Wendeschneidplatten mit AS-Anschnitt

Vorschub und Schnittgeschwindigkeit

AS-HP115

MZG*	Werkstoff	Festigkeit/Härte [N/mm ²] [HRC]	Schnittgeschwindigkeit v _c (m/min)		Vorschub f _z (mm/u)	
			Innen- kühlung	Außen- kühlung		
P P1	P1.1	Bau-, Automaten-, Einsatz- und Vergütungsstähle, unlegiert	< 700	80	40	0,150
	P1.2	Bau-, Automaten-, Einsatz- und Vergütungsstähle, unlegiert	< 1200	70	35	0,150

AS-HP425

MZG*	Werkstoff	Festigkeit/Härte [N/mm ²] [HRC]	Schnittgeschwindigkeit v _c (m/min)		Vorschub f _z (mm/u)	
			Innen- kühlung	Außen- kühlung		
P P2 P3 P5	P2.1	Nitrier-, Einsatz- und Vergütungsstähle, legiert	< 900	100	50	0,150
	P2.2	Nitrier-, Einsatz- und Vergütungsstähle, legiert	< 1400	80	40	0,150
	P3.1	Werkzeug-, Wälzlager-, Feder- und Schnellarbeitsstähle**	< 900	100	50	0,150
	P3.2	Werkzeug-, Wälzlager-, Feder- und Schnellarbeitsstähle**	< 1500	80	40	0,150
	P5.1	Stahlguss		80	40	0,150

AS-HP016

MZG*	Werkstoff	Festigkeit/Härte [N/mm ²] [HRC]	Schnittgeschwindigkeit v _c (m/min)		Vorschub f _z (mm/u)	
			Innen- kühlung	Außen- kühlung		
P P4 P6	P4.1	Rostfreie Stähle, ferritisch und martensitisch		50	25	0,120
	P6.1	Rostfreier Stahlguss, ferritisch und martensitisch		40	20	0,120
M M1 M2 M3	M1.1	Rostfreie Stähle, austenitisch	< 700	50	25	0,120
	M1.2	Rostfreie Stähle, ferritisch/austenitisch (Duplex)	< 1000	30	15	0,120
	M2.1	Rostfreier Stahlguss, austenitisch	< 700	50	25	0,120
M3.1	Rostfreier Stahlguss, ferritisch/austenitisch (Duplex)	< 1000	30	15	0,120	

AS-HP612

MZG*	Werkstoff	Festigkeit/Härte [N/mm ²] [HRC]	Schnittgeschwindigkeit v _c (m/min)		Vorschub f _z (mm/u)	
			Innen- kühlung	Außen- kühlung		
N N1	N1.1	Aluminium, unlegiert und legiert < 3 % Si		160	80	0,150
	N1.2	Aluminium, legiert ≤ 7 % Si		160	80	0,150

* MAPAL Zerspanungsgruppen

** Wenn die Legierungsbestandteile Cr, Mo, Ni, V, W in Summe > 8 %, dann die nächst höhere MAPAL Zerspanungsgruppe wählen.

AS-HU615

MZG*		Werkstoff	Festigkeit/Härte [N/mm ²] [HRC]	Schnittgeschwindigkeit v _c (m/min)		Vorschub f _z (mm/u)
				Innen- kühlung	Außen- kühlung	
N	N2.1	Kupfer, unlegiert und niedriglegiert	< 300	100	50	0,150
	N2.2	Kupfer, legiert	> 300	100	50	0,150
	N2.3	Messing, Bronze, Rotguss	< 1200	100	50	0,150
S	S1.1	Titan, Titanlegierungen	< 400	30	15	0,120
	S2.1	Titan, Titanlegierungen	< 1200	20	10	0,120
	S2.2	Titan, Titanlegierungen	> 1200	20	10	0,100

AS-CP122

MZG*		Werkstoff	Festigkeit/Härte [N/mm ²] [HRC]	Schnittgeschwindigkeit v _c (m/min)		Vorschub f _z (mm/u)
				Innen- kühlung	Außen- kühlung	
P1	P1.1	Bau-, Automaten-, Einsatz- und Vergütungsstähle, unlegiert	< 700	180	90	0,150
	P1.2	Bau-, Automaten-, Einsatz- und Vergütungsstähle, unlegiert	< 1200	160	80	0,120
P2	P2.1	Nitrier-, Einsatz- und Vergütungsstähle, legiert	< 900	160	80	0,150
	P2.2	Nitrier-, Einsatz- und Vergütungsstähle, legiert	< 1400	140	70	0,120
P3	P3.1	Werkzeug-, Wälzlager-, Feder- und Schnellarbeitsstähle**	< 800	160	80	0,150
	P3.2	Werkzeug-, Wälzlager-, Feder- und Schnellarbeitsstähle**	< 1000	160	80	0,150
	P3.3	Werkzeug-, Wälzlager-, Feder- und Schnellarbeitsstähle**	< 1500	140	70	0,120
P5	P5.1	Stahlguss		140	70	0,120

AS-PU620

MZG*		Werkstoff	Festigkeit/Härte [N/mm ²] [HRC]	Schnittgeschwindigkeit v _c (m/min)		Vorschub f _z (mm/u)	
				Innen- kühlung	Außen- kühlung		
N	N1	N1.1	Aluminium, unlegiert und legiert < 3 % Si		230	115	0,150
		N1.2	Aluminium, legiert ≤ 7 % Si		230	115	0,150
		N1.3	Aluminium, legiert > 7-12 % Si		230	115	0,150
		N1.4	Aluminium, legiert > 12 % Si		230	115	0,150
N	N2	N2.1	Kupfer, unlegiert und niedriglegiert	< 300	180	90	0,150
		N2.2	Kupfer, legiert	> 300	180	90	0,150
		N2.3	Messing, Bronze, Rotguss	< 1200	180	90	0,150

Die angegebenen Schnittwerte sind Richtwerte.

Die für den jeweiligen Bearbeitungsfall optimalen Daten sollten im Versuch oder während der Bearbeitung ermittelt werden.

Schnittwertempfehlung für Wendeschneidplatten mit AZ-Anschnitt

Vorschub und Schnittgeschwindigkeit

AZ-HC418

MZG*	Werkstoff	Festigkeit/Härte [N/mm ²] [HRC]	Schnittgeschwindigkeit v _c (m/min)		Vorschub f _z (mm/u)
			Innen- kühlung	Außen- kühlung	
K K1 K1.1	Gusseisen mit Lamellengraphit (Grauguss), GJL	< 300	110	55	0,150

AZ-HP426

MZG*	Werkstoff	Festigkeit/Härte [N/mm ²] [HRC]	Schnittgeschwindigkeit v _c (m/min)		Vorschub f _z (mm/u)
			Innen- kühlung	Außen- kühlung	
K K2	K2.1 Gusseisen mit Kugelgraphit, GJS	< 500	110	55	0,150
	K2.2 Gusseisen mit Kugelgraphit, GJS	≤ 800	100	50	0,150
	K2.3 Gusseisen mit Kugelgraphit, GJS	> 800	80	40	0,150
K K3	K3.1 Gusseisen mit Vermiculargraphit, GJV; Temperguss, GJM	< 500	80	40	0,150
	K3.2 Gusseisen mit Vermiculargraphit, GJV; Temperguss, GJM	> 500	80	40	0,150

AZ-HP612

MZG*	Werkstoff	Festigkeit/Härte [N/mm ²] [HRC]	Schnittgeschwindigkeit v _c (m/min)		Vorschub f _z (mm/u)
			Innen- kühlung	Außen- kühlung	
N N1	N1.1 Aluminium, unlegiert und legiert < 3 % Si		160	80	0,150
	N1.2 Aluminium, legiert ≤ 7 % Si		160	80	0,150

AZ-HU615

MZG*	Werkstoff	Festigkeit/Härte [N/mm ²] [HRC]	Schnittgeschwindigkeit v _c (m/min)		Vorschub f _z (mm/u)
			Innen- kühlung	Außen- kühlung	
N2	N2.1 Kupfer, unlegiert und niedriglegiert	< 300	110	55	0,150
	N2.2 Kupfer, legiert	> 300	110	55	0,150
	N2.3 Messing, Bronze, Rotguss	< 1200	110	55	0,150

AZ-PU620

MZG*	Werkstoff	Festigkeit/Härte [N/mm ²] [HRC]	Schnittgeschwindigkeit v _c (m/min)		Vorschub f _z (mm/u)	
			Innen- kühlung	Außen- kühlung		
N	N1	N1.1 Aluminium, unlegiert und legiert < 3 % Si	230	115	0,150	
		N1.2 Aluminium, legiert ≤ 7 % Si	230	115	0,150	
		N1.3 Aluminium, legiert > 7-12 % Si	230	115	0,150	
		N1.4 Aluminium, legiert > 12 % Si	230	115	0,150	
N2	N2	N2.1 Kupfer, unlegiert und niedriglegiert	< 300	180	90	0,150
		N2.2 Kupfer, legiert	> 300	180	90	0,150
		N2.3 Messing, Bronze, Rotguss	< 1200	180	90	0,150

AZ-FU485

MZG*	Werkstoff	Festigkeit/Härte [N/mm ²] [HRC]	Schnittgeschwindigkeit v _c (m/min)		Vorschub f _z (mm/u)
			Innen- kühlung	Außen- kühlung	
K K1	K1.1 Gusseisen mit Lamellengraphit (Grauguss), GJL	< 300	160	80	0,150

Die angegebenen Schnittwerte sind Richtwerte.

Die für den jeweiligen Bearbeitungsfall optimalen Daten sollten im Versuch oder während der Bearbeitung ermittelt werden.

Schnittwertempfehlung für Wendeschneidplatten mit DZ-Anschnitt

Vorschub und Schnittgeschwindigkeit

DZ-HP115

MZG*	Werkstoff	Festigkeit/Härte [N/mm ²] [HRC]	Schnittgeschwindigkeit v_c (m/min)		Vorschub f_z (mm/u)	
			Innen- kühlung	Außen- kühlung		
P P1	P1.1	Bau-, Automaten-, Einsatz- und Vergütungsstähle, unlegiert	< 700	80	40	0,150
	P1.2	Bau-, Automaten-, Einsatz- und Vergütungsstähle, unlegiert	< 1200	70	35	0,150

DZ-HP425

MZG*	Werkstoff	Festigkeit/Härte [N/mm ²] [HRC]	Schnittgeschwindigkeit v_c (m/min)		Vorschub f_z (mm/u)	
			Innen- kühlung	Außen- kühlung		
P P2 P3 P5	P2.1	Nitrier-, Einsatz- und Vergütungsstähle, legiert	< 900	100	50	0,150
	P2.2	Nitrier-, Einsatz- und Vergütungsstähle, legiert	< 1400	80	40	0,150
	P3.1	Werkzeug-, Wälzlager-, Feder- und Schnellarbeitsstähle**	< 900	100	50	0,150
	P3.2	Werkzeug-, Wälzlager-, Feder- und Schnellarbeitsstähle**	< 1500	80	40	0,150
	P5.1	Stahlguss		80	40	0,150

DZ-HP016

MZG*	Werkstoff	Festigkeit/Härte [N/mm ²] [HRC]	Schnittgeschwindigkeit v_c (m/min)		Vorschub f_z (mm/u)	
			Innen- kühlung	Außen- kühlung		
P P4 P6	P4.1	Rostfreie Stähle, ferritisch und martensitisch		50	25	0,120
	P6.1	Rostfreier Stahlguss, ferritisch und martensitisch		40	20	0,120
M M1 M2 M3	M1.1	Rostfreie Stähle, austenitisch	< 700	50	25	0,120
	M1.2	Rostfreie Stähle, ferritisch/austenitisch (Duplex)	< 1000	30	15	0,120
	M2.1	Rostfreier Stahlguss, austenitisch	< 700	50	25	0,120
M3.1	Rostfreier Stahlguss, ferritisch/austenitisch (Duplex)	< 1000	30	15	0,120	

DZ-HC418

MZG*	Werkstoff	Festigkeit/Härte [N/mm ²] [HRC]	Schnittgeschwindigkeit v_c (m/min)		Vorschub f_z (mm/u)	
			Innen- kühlung	Außen- kühlung		
K K1	K1.1	Gusseisen mit Lamellengraphit (Grauguss), GJL	< 300	100	50	0,150

* MAPAL Zerspanungsgruppen

** Wenn die Legierungsbestandteile Cr, Mo, Ni, V, W in Summe > 8 %, dann die nächst höhere MAPAL Zerspanungsgruppe wählen.

DZ-HP426

MZG*	Werkstoff	Festigkeit/Härte [N/mm ²] [HRC]	Schnittgeschwindigkeit v _c (m/min)		Vorschub f _z (mm/u)
			Innen- kühlung	Außen- kühlung	
K2	K2.1 Gusseisen mit Kugelgraphit, GJS	< 500	100	50	0,150
	K2.2 Gusseisen mit Kugelgraphit, GJS	≤ 800	90	45	0,150
	K2.3 Gusseisen mit Kugelgraphit, GJS	> 800	80	40	0,150
K3	K3.1 Gusseisen mit Vermiculargraphit, GJV; Temperguss, GJM	< 500	70	35	0,150
	K3.2 Gusseisen mit Vermiculargraphit, GJV; Temperguss, GJM	> 500	70	35	0,150

DZ-HP612

MZG*	Werkstoff	Festigkeit/Härte [N/mm ²] [HRC]	Schnittgeschwindigkeit v _c (m/min)		Vorschub f _z (mm/u)
			Innen- kühlung	Außen- kühlung	
N N1	N1.1 Aluminium, unlegiert und legiert < 3 % Si		160	80	0,150
	N1.2 Aluminium, legiert ≤ 7 % Si		160	80	0,150

DZ-HU615

MZG*	Werkstoff	Festigkeit/Härte [N/mm ²] [HRC]	Schnittgeschwindigkeit v _c (m/min)		Vorschub f _z (mm/u)
			Innen- kühlung	Außen- kühlung	
N N2	N2.1 Kupfer, unlegiert und niedriglegiert	< 300	100	50	0,150
	N2.2 Kupfer, legiert	> 300	100	50	0,150
	N2.3 Messing, Bronze, Rotguss	< 1200	100	50	0,150
S S1 S2	S1.1 Titan, Titanlegierungen	< 400	30	15	0,120
	S2.1 Titan, Titanlegierungen	< 1200	20	10	0,120
	S2.2 Titan, Titanlegierungen	> 1200	20	10	0,100

DZ-HP016

MZG*	Werkstoff	Festigkeit/Härte [N/mm ²] [HRC]	Schnittgeschwindigkeit v _c (m/min)		Vorschub f _z (mm/u)
			Innen- kühlung	Außen- kühlung	
H H1 H1.1	Gehärteter Stahl/Stahlguss	45 - 55	30	15	0,12

Die angegebenen Schnittwerte sind Richtwerte.

Die für den jeweiligen Bearbeitungsfall optimalen Daten sollten im Versuch oder während der Bearbeitung ermittelt werden.

Schnittwertempfehlung für Wendeschneidplatten mit DZ-Anschnitt

Vorschub und Schnittgeschwindigkeit

DZ-CP122

MZG*		Werkstoff	Festigkeit/Härte [N/mm ²] [HRC]	Schnittgeschwindigkeit v_c (m/min)		Vorschub f_z (mm/u)
				Innen- kühlung	Außen- kühlung	
P1	P1.1	Bau-, Automaten-, Einsatz- und Vergütungsstähle, unlegiert	< 700	180	80	0,150
	P1.2	Bau-, Automaten-, Einsatz- und Vergütungsstähle, unlegiert	< 1200	160	80	0,120
P2	P2.1	Nitrier-, Einsatz- und Vergütungsstähle, legiert	< 900	160	80	0,150
	P2.2	Nitrier-, Einsatz- und Vergütungsstähle, legiert	< 1400	140	70	0,120
P3	P3.1	Werkzeug-, Wälzlager-, Feder- und Schnellarbeitsstähle**	< 800	160	80	0,150
	P3.2	Werkzeug-, Wälzlager-, Feder- und Schnellarbeitsstähle**	< 1000	160	80	0,150
	P3.3	Werkzeug-, Wälzlager-, Feder- und Schnellarbeitsstähle**	< 1500	140	70	0,120
P5	P5.1	Stahlguss		140	70	0,120

DZ-PU620

MZG*		Werkstoff	Festigkeit/Härte [N/mm ²] [HRC]	Schnittgeschwindigkeit v_c (m/min)		Vorschub f_z (mm/u)
				Innen- kühlung	Außen- kühlung	
N1	N1.1	Aluminium, unlegiert und legiert < 3 % Si		230	150	0,15
	N1.2	Aluminium, legiert \leq 7 % Si		230	150	0,15
	N1.3	Aluminium, legiert > 7-12 % Si		230	150	0,15
	N1.4	Aluminium, legiert > 12 % Si		230	150	0,15
N2	N2.1	Kupfer, unlegiert und niedriglegiert	< 300	180	90	0,15
	N2.2	Kupfer, legiert	> 300	180	90	0,15
	N2.3	Messing, Bronze, Rotguss	< 1200	180	90	0,15

DZ-FU485

MZG*		Werkstoff	Festigkeit/Härte [N/mm ²] [HRC]	Schnittgeschwindigkeit v_c (m/min)		Vorschub f_z (mm/u)	
				Innen- kühlung	Außen- kühlung		
K	K1	K1.1	Gusseisen mit Lamellengraphit (Grauguss), GJL	< 300	150	75	0,150

DZ-FU801

MZG*		Werkstoff	Festigkeit/Härte [N/mm ²] [HRC]	Schnittgeschwindigkeit v_c (m/min)		Vorschub f_z (mm/u)	
				Innen- kühlung	Außen- kühlung		
H	H1	H1.1	Gehärteter Stahl/Stahlguss	45 - 55	60	30	0,100
		H1.2	Gehärteter Stahl/Stahlguss	55 - 64	50	25	0,080

* MAPAL Zerspanungsgruppen

** Wenn die Legierungsbestandteile Cr, Mo, Ni, V, W in Summe > 8 %, dann die nächst höhere MAPAL Zerspanungsgruppe wählen.

Schnittwertempfehlung für Wendeschneidplatten mit EK-Anschnitt

Vorschub und Schnittgeschwindigkeit

EK-HP115

MZG*	Werkstoff	Festigkeit/Härte [N/mm ²] [HRC]	Schnittgeschwindigkeit v _c (m/min)		Vorschub f _z (mm/u)	
			Innen- kühlung	Außen- kühlung		
P P1	P1.1	Bau-, Automaten-, Einsatz- und Vergütungsstähle, unlegiert	< 700	80	40	0,150
	P1.2	Bau-, Automaten-, Einsatz- und Vergütungsstähle, unlegiert	< 1200	70	35	0,150

EK-HP425

MZG*	Werkstoff	Festigkeit/Härte [N/mm ²] [HRC]	Schnittgeschwindigkeit v _c (m/min)		Vorschub f _z (mm/u)	
			Innen- kühlung	Außen- kühlung		
P P2 P3 P5	P2.1	Nitrier-, Einsatz- und Vergütungsstähle, legiert	< 900	100	50	0,150
	P2.2	Nitrier-, Einsatz- und Vergütungsstähle, legiert	< 1400	80	40	0,150
	P3.1	Werkzeug-, Wälzlager-, Feder- und Schnellarbeitsstähle**	< 900	100	50	0,150
	P3.2	Werkzeug-, Wälzlager-, Feder- und Schnellarbeitsstähle**	< 1500	80	40	0,150
	P5.1	Stahlguss		80	40	0,150

EK-HP016

MZG*	Werkstoff	Festigkeit/Härte [N/mm ²] [HRC]	Schnittgeschwindigkeit v _c (m/min)		Vorschub f _z (mm/u)	
			Innen- kühlung	Außen- kühlung		
P4 P6	P4.1	Rostfreie Stähle, ferritisch und martensitisch		50	25	0,120
	P6.1	Rostfreier Stahlguss, ferritisch und martensitisch		40	20	0,120
M M1 M2 M3	M1.1	Rostfreie Stähle, austenitisch	< 700	50	25	0,120
	M1.2	Rostfreie Stähle, ferritisch/austenitisch (Duplex)	< 1000	30	15	0,120
	M2.1	Rostfreier Stahlguss, austenitisch	< 700	50	25	0,120
M3.1	Rostfreier Stahlguss, ferritisch/austenitisch (Duplex)	< 1000	30	15	0,120	

EK-HP612

MZG*	Werkstoff	Festigkeit/Härte [N/mm ²] [HRC]	Schnittgeschwindigkeit v _c (m/min)		Vorschub f _z (mm/u)	
			Innen- kühlung	Außen- kühlung		
N N1	N1.1	Aluminium, unlegiert und legiert < 3 % Si		160	80	0,15
	N1.2	Aluminium, legiert ≤ 7 % Si		160	80	0,15

Die angegebenen Schnittwerte sind Richtwerte.

Die für den jeweiligen Bearbeitungsfall optimalen Daten sollten im Versuch oder während der Bearbeitung ermittelt werden.

Schnittwertempfehlung für Wendeschnidplatten mit EK-Anschnitt

Vorschub und Schnittgeschwindigkeit

EK-HU615

MZG*	Werkstoff	Festigkeit/Härte [N/mm ²] [HRC]	Schnittgeschwindigkeit v _c (m/min)		Vorschub f _z (mm/u)
			Innen- kühlung	Außen- kühlung	
N N2	N2.1 Kupfer, unlegiert und niedriglegiert	< 300	100	50	0,150
	N2.2 Kupfer, legiert	> 300	100	50	0,150
	N2.3 Messing, Bronze, Rotguss	< 1200	100	50	0,150
S S1 S2	S1.1 Titan, Titanlegierungen	< 400	30	15	0,120
	S2.1 Titan, Titanlegierungen	< 1200	20	10	0,120
	S2.2 Titan, Titanlegierungen	> 1200	20	10	0,100

EK-CP122

MZG*	Werkstoff	Festigkeit/Härte [N/mm ²] [HRC]	Schnittgeschwindigkeit v _c (m/min)		Vorschub f _z (mm/u)
			Innen- kühlung	Außen- kühlung	
P P1 P2 P3 P5	P1.1 Bau-, Automaten-, Einsatz- und Vergütungsstähle, unlegiert	< 700	180	90	0,150
	P1.2 Bau-, Automaten-, Einsatz- und Vergütungsstähle, unlegiert	< 1200	160	80	0,120
	P2.1 Nitrier-, Einsatz- und Vergütungsstähle, legiert	< 900	160	80	0,150
	P2.2 Nitrier-, Einsatz- und Vergütungsstähle, legiert	< 1400	140	70	0,120
	P3.1 Werkzeug-, Wälzlager-, Feder- und Schnellarbeitsstähle**	< 800	160	80	0,150
	P3.2 Werkzeug-, Wälzlager-, Feder- und Schnellarbeitsstähle**	< 1000	160	80	0,150
	P3.3 Werkzeug-, Wälzlager-, Feder- und Schnellarbeitsstähle**	< 1500	140	70	0,120
	P5.1 Stahlguss		140	70	0,120

EK-PU620

MZG*	Werkstoff	Festigkeit/Härte [N/mm ²] [HRC]	Schnittgeschwindigkeit v _c (m/min)		Vorschub f _z (mm/u)
			Innen- kühlung	Außen- kühlung	
N N1 N2	N1.1 Aluminium, unlegiert und legiert < 3 % Si		230	115	0,150
	N1.2 Aluminium, legiert ≤ 7 % Si		230	115	0,150
	N1.3 Aluminium, legiert > 7-12 % Si		230	115	0,150
	N1.4 Aluminium, legiert > 12 % Si		230	115	0,150
	N2.1 Kupfer, unlegiert und niedriglegiert	< 300	180	90	0,150
	N2.2 Kupfer, legiert	> 300	180	90	0,150
	N2.3 Messing, Bronze, Rotguss	< 1200	180	90	0,150

* MAPAL Zerspanungsgruppen

** Wenn die Legierungsbestandteile Cr, Mo, Ni, V, W in Summe > 8 %, dann die nächst höhere MAPAL Zerspanungsgruppe wählen.

Schnittwertempfehlung für Wendeschneidplatten mit SZ-Anschnitt

Vorschub und Schnittgeschwindigkeit

SZ-HP612

MZG*	Werkstoff	Festigkeit/Härte [N/mm ²] [HRC]	Schnittgeschwindigkeit v _c (m/min)		Vorschub f _z (mm/u)
			Innen- kühlung	Außen- kühlung	
N N1	N1.1 Aluminium, unlegiert und legiert < 3 % Si		160	80	0,120
	N1.2 Aluminium, legiert ≤ 7 % Si		160	80	0,120

SZ-HU615

MZG*	Werkstoff	Festigkeit/Härte [N/mm ²] [HRC]	Schnittgeschwindigkeit v _c (m/min)		Vorschub f _z (mm/u)
			Innen- kühlung	Außen- kühlung	
N2	N2.1 Kupfer, unlegiert und niedriglegiert	< 300	100	50	0,120
	N2.2 Kupfer, legiert	> 300	100	50	0,120
	N2.3 Messing, Bronze, Rotguss	< 1200	100	50	0,120

SZ-PU620

MZG*	Werkstoff	Festigkeit/Härte [N/mm ²] [HRC]	Schnittgeschwindigkeit v _c (m/min)		Vorschub f _z (mm/u)
			Innen- kühlung	Außen- kühlung	
N N1	N1.1 Aluminium, unlegiert und legiert < 3 % Si		230	115	0,120
	N1.2 Aluminium, legiert ≤ 7 % Si		230	115	0,120
	N1.3 Aluminium, legiert > 7-12 % Si		230	115	0,120
	N1.4 Aluminium, legiert > 12 % Si		230	115	0,120
N2	N2.1 Kupfer, unlegiert und niedriglegiert	< 300	180	90	0,120
	N2.2 Kupfer, legiert	> 300	180	90	0,120
	N2.3 Messing, Bronze, Rotguss	< 1200	180	90	0,120

Die angegebenen Schnittwerte sind Richtwerte.

Die für den jeweiligen Bearbeitungsfall optimalen Daten sollten im Versuch oder während der Bearbeitung ermittelt werden.



EasyAdjust-System

Einfaches Einstellen von Werkzeugen in kürzester Zeit

Die drastische Reduzierung des Einstellaufwandes bei Werkzeugen mit Führungsleistentechnologie war das Ziel bei der Entwicklung des EasyAdjust-Systems.

Im Mittelpunkt des EasyAdjust-Systems steht eine innovative Kassette, die die sechs- beziehungsweise vierschneidigen Wendepplatten spielfrei und stabil aufnimmt. Die Verjüngung der Nebenschneide ist bereits in die Kassette integriert, somit entfällt dieser Einstellaufwand.

Durch die exakte Führung der Kassette auf einem Präzisionsführungsstift bleibt die Verjüngung auch während der DurchmesserEinstellung unverändert. Für unterschiedliche

Verjüngungen stehen die jeweils passenden Kassetten zur Verfügung. Sie können je nach Anwendungsfall gewählt und eingesetzt werden – unabhängig von Wendeschneidplatte und Werkzeug.

Deutliche Wirtschaftlichkeitsvorteile

In der Praxis ergeben sich durch dieses System Wirtschaftlichkeitsvorteile: Die HX-Wendeschneidplatten mit sechs nutzbaren Schneidkanten können in Kassetten mit verschiedenen Verjüngungen schnell und präzise eingesetzt werden. Werkzeuge mit EasyAdjust-System müssen nur noch im Durchmesser eingestellt werden. Dadurch erhöht sich die Prozesssicherheit beim Schneidenwechsel. Ein Effekt, der umso größer wird, je mehr

Schneiden in einem Werkzeug verbaut sind. Die Zeit für den Einstellaufwand pro Schneide wird durch die Neuentwicklung auf einen Bruchteil reduziert.

VORTEILE

- Einstellaufwand drastisch reduziert
- Werkzeuge müssen nur noch im Durchmesser eingestellt werden
- Wirtschaftlichkeit, Handhabung und Prozesssicherheit deutlich erhöht im Vergleich zu Werkzeugen mit Führungsleisten ohne EA-System
- Präzision unverändert hoch

Systemübersicht

Das EasyAdjust-System im Detail

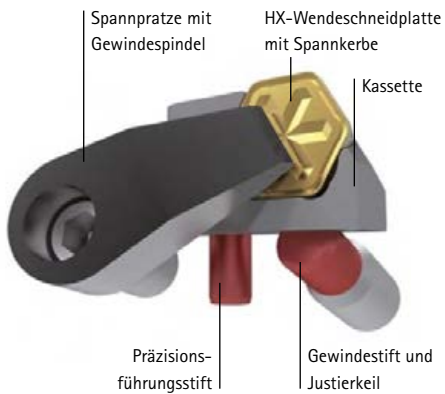

Das EasyAdjust-System besteht aus einer Präzisionskassette, die die Wendeschneidplatte aufnimmt. Über einen Präzisionsführungsstift wird die Kassette bei der Justierung geführt. Für den sicheren Halt der Wendeschneidplatte sorgt eine Spannkerbe, die zusammen mit der Spannpratze ein kraftschlüssiges und stabiles System bildet.

Werkzeuge mit EasyAdjust-System müssen nur noch im Durchmesser eingestellt werden. Die Verjüngung ist in der Kassette bereits integriert und bleibt bei Durchmesseränderungen unverändert.

VORTEILE

- Einstellzeit halbiert
- Exakte Führung des Systems auf Präzisionsführungsstift
- Verjüngung in Kassette bereits integriert
- Optimale Schneidstoffnutzung durch vier- und sechsschneidige Wendeschneidplatten

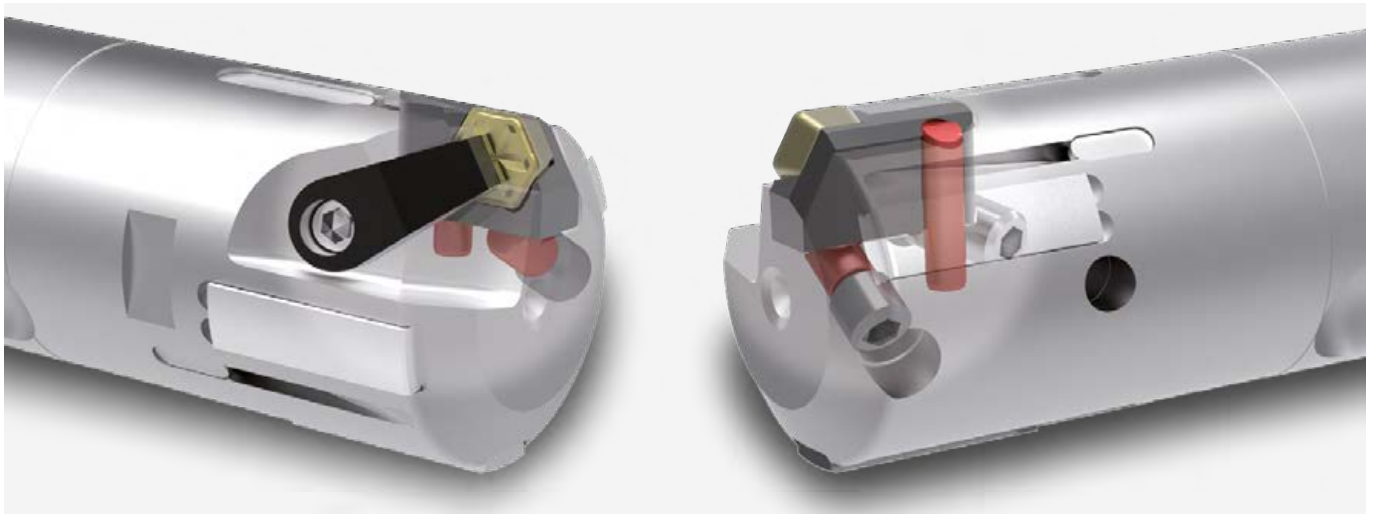

Vergleich der Einstellzeiten

Die Zeit für den Einstellaufwand pro Schneide wird durch das EasyAdjust-System drastisch reduziert.

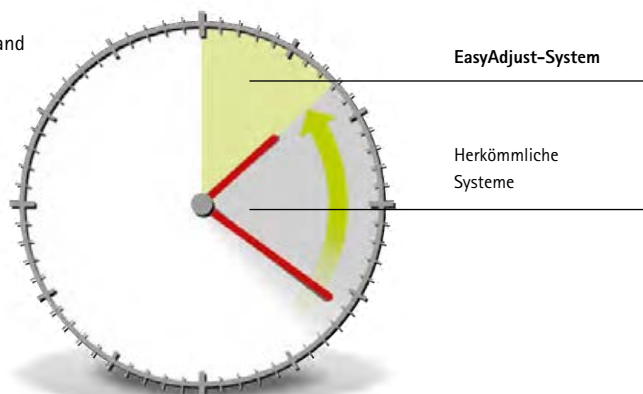

Schneidenverjüngung

Die Verjüngung der Schneide hat wesentlichen Einfluss auf die Bohrungsqualität. Den Anforderungen des Werkstoffs und Vorschubs entsprechend wählt MAPAL die für den Bearbeitungsfall notwendige Schneidenverjüngung der Kassette.

VORTEILE

- Anpassung der Verjüngung unabhängig von Wendeschneidplatte und Werkzeuggrundkörper
- Erzeugen definierter Rauigkeiten durch verschiedene Verjüngungen
- Optimale Oberflächenbeschaffenheit für achfolgende Prozesse (zum Beispiel Honen)

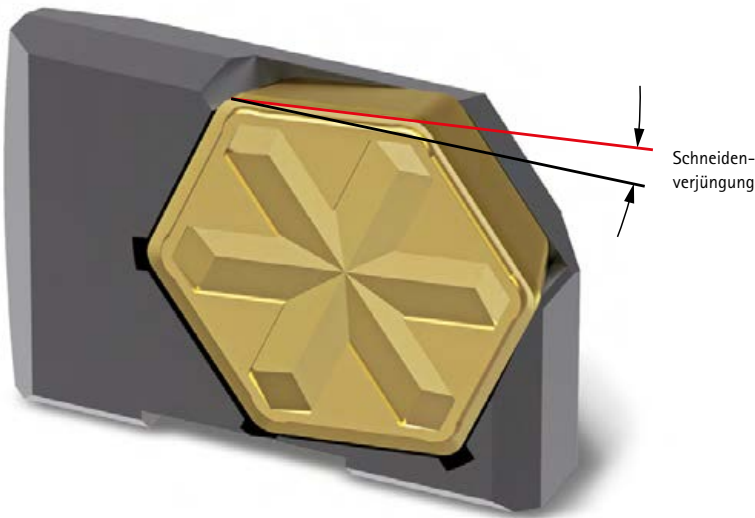

Zwei Varianten der Wendeschneidplatten

Das EasyAdjust-System wird für Durchgangs- und Grundbohrungen mit zwei unterschiedlichen Schneidentypen angeboten:

HX-Wendeschneidplatte

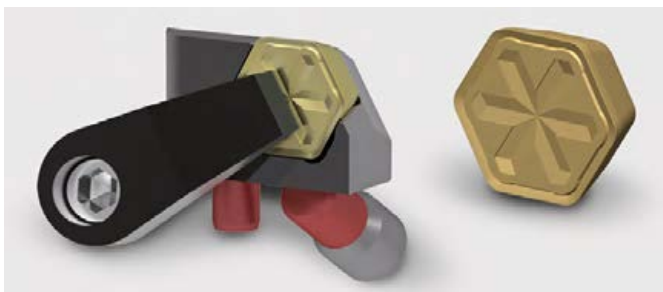

HX-Wendeschneidplatte mit sechs Schneidkanten für Durchgangsbohrungen.

TEC-Wendeschneidplatte

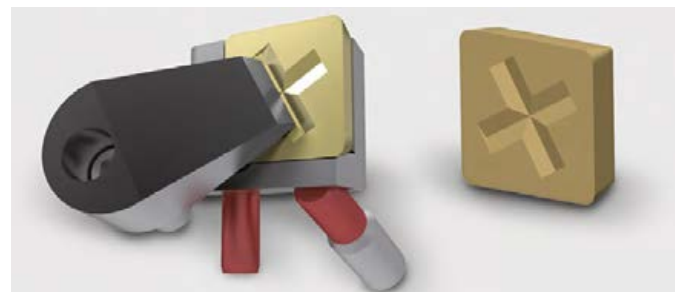

TEC-Wendeschneidplatte mit vier Schneidkanten und verschiedenen Anschnittgeometrien für Grundbohrung und Planschulterbearbeitungen.



Durchgangsbohrung

Geeignet für offene Bohrungen. Nicht geeignet für Schulterbearbeitungen, wenn 90° gefordert sind.



Grund- und Planschulterbohrung

Geeignet für geschlossene Bohrungen und Schulterbearbeitungen, unter Berücksichtigung der Schneidkantenlänge.

Auswahlübersicht





EasyAdjust-System mit HX-Wendeschneidplatten

Auswahlkriterien					Schneidentyp
Bohrungsart	Ø-Bereich Werkzeug	i	Abstufung der Verjüngung*		
Durchgangs- bohrung 	ab Ø 20	B	Besondere Anforderungen	Verjüngung ↓ - + ↓	HX 
		D	Empfohlener Standard		
		F	Besondere Anforderungen		
		H			
		K			
		M			
		P			
		R			
	ab Ø 30	B	Besondere Anforderungen	Verjüngung ↓ - + ↓	
		D	Empfohlener Standard		
		F	Besondere Anforderungen		
		H			
		K			
		M			
P					
R					

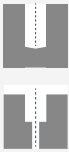

EasyAdjust-System mit TEC-Wendeschneidplatten

Auswahlkriterien					Schneidentyp
Bohrungsart	Ø-Bereich Werkzeug	i	Abstufung der Verjüngung*		
Grundbohrung / Planschulter 	ab Ø 20	B	Besondere Anforderungen	Verjüngung ↓ - + ↓	TEC 
		D	Empfohlener Standard		
		F	Besondere Anforderungen		
		H			
		K			
		M			
		P			
		R			
	ab Ø 30	B	Besondere Anforderungen	Verjüngung ↓ - + ↓	
		D	Empfohlener Standard		
		F	Besondere Anforderungen		
		H			
		K			
		M			
P					
R					

Maßangaben in mm.

Hierzu passende Wendeschneidplatten siehe Seite 518.

* Auswahl je nach Bauteilanforderungen in Absprache mit MAPAL.

Hinweis:

Bei Systemwechsel unbedingt beachten, dass Kassette und Spannplatte entsprechend angepasst werden müssen.

HX-Wendescheidplatten für Bohrungsbearbeitung

Für Werkzeuge mit Führungsleisten

Schneidstoff			Hartmetall							
MZG*	P			M	K	N				
	1.1 - 1.2	2 - 3 5	4 6	1 - 3	1.1	2 - 3	1.1 - 1.2	2.3	2.1 - 2.2	
Schneidstoffsorte			HP342	HP122	HP018	HP018	HC419	HP122	HP612	HU612

Span- formgeom.	Bau- größe	An- schnitt	Spezifikation	Bestell-Nr.							
negativ	2	R0,8	WP-K1288-2133-...								
	3	R0,8	WP-K1288-2123-...								
neutral	2	R0,8	WP-606087689-...					30688944			
	3	R0,8	WP-606087714-...					30688981			
positiv	2	R0,8	WP-HX228RL-...	30685704	30197811	31100892	31100892		30197811		30320977
	3	R0,8	WP-HX238RL-...	30685705	30669024	31100893	31100893		30669024		30669021
hoch positiv	2	R0,8	WP-HX128RL-...							30685707	30669011
	3	R0,8	WP-HX138RL-...							30685708	30669015



Hartmetall		
S		H
1 - 2		1.1
HU612		HP018
Bestell-Nr.		
		31100892
		31100893
	30669011	
	30669015	

Cermet	
P	
1 - 3 5	
CP122	
Bestell-Nr.	
	30222667
	30222666

PKD	
N	
1 - 2	
PU620	
Bestell-Nr.	
	31290969
	31290980

PcBN		
K	H	
1.1		1.1 - 1.2
FU485		FU801
Bestell-Nr.		
30009396		30033403
30008170		30097476

TEC-Wendeschnidplatten für Bohrungsbearbeitung

Für Werkzeuge mit Führungsleisten

Schnidstoff	Hartmetall								
	P				M	K	N		
MZG*	1.1 - 1.2	2 - 3 5	4 6	1 - 3	1.1	2 - 3	1.1 - 1.2	2.3	2.1 - 2.2
Schnidstoffsorte	HP115	HP425	HP016	HP016	HC418	HP426	HP612	HU615	

Span- formgeom.	Bau- größe	An- schnitt	Spezifikation	Bestell-Nr.								
negativ	2	AS	WP-TEC2-ASS35R0A-...									
		** EK	WP-TEC2-EKS35R0A-...									
		DZ	WP-TEC2-DZS35R0A-...									
		** R0,4	WP-TEC2-04S35R0A-...									

neutral	2	AS	WP-TEC2-ASE02R0A-...									
		** EK	WP-TEC2-EKE02R0A-...									
		DZ	WP-TEC2-DZE02R0A-...					31306739				
		** R0,4	WP-TEC2-04E02R0A-...					31306750				

positiv	2	AS	WP-TEC2-ASF01R1G-...	31099198	30953115	31099199	31099199				31306751	
		** EK	WP-TEC2-EKF01R1G-...	31306755	31306756	31306758	31306758				31306761	
		DZ	WP-TEC2-DZF01R1G-...	31306854	31100514	31100517	31100517		31306855		31306857	
		** R0,4	WP-TEC2-04F01R1J-...	31306873	31306875	31306876	31306876		31306878		31306879	

hoch positiv	2	AS	WP-TEC2-ASF01R1N-...							31306883		31306887
		** EK	WP-TEC2-EKF01R1N-...							31306903		31306904
		DZ	WP-TEC2-DZF01R1N-...							31306907		31306920
		** R0,4	WP-TEC2-04F01R1U-...							30685231		31306921

** Hinweis: Anschnitt EK und R0,4 nur für die Bearbeitung von Grundbohrungen und bauteilbedingte Planbearbeitungen verwenden



Hartmetall		Cermet		PKD		PcBN	
S	H	P	N	K	H		
1 - 2	1.1	1 - 3 5	1 - 2	1.1	1.1 - 1.2		
HU615	HP016	CP122	PU620	FU485	FU801		
Bestell-Nr.		Bestell-Nr.		Bestell-Nr.		Bestell-Nr.	
						31306734	31306735
						30539027	30688967
		31306753	31306754				
		31306762	31306763				
	31100517	31306870	31306871				
	31306876	31306880	30823892				
	31306887						
	31306904						
	31306920						
	31306921						

Zubehör für EasyAdjust-System



Schneidengröße TEC	Messerkassetten für EasyAdjust-System		Klemmplatten für EasyAdjust-System	
	Spezifikation	Bestell-Nr.	Spezifikation	Bestell-Nr.
2	BC-EAS-R-42-B	30546828	CP-EAS-R-N2-B	30508276
2	BC-EAS-R-42-D	30498068	CP-EAS-R-N2-D	30561484
2	BC-EAS-R-42-F	30503101	CP-EAS-R-N2-F	30561485
2	BC-EAS-R-42-H	30503104	CP-EAS-R-N2-H	30561487
2	BC-EAS-R-42-K	30546837	CP-EAS-R-N2-K	30561488
2	BC-EAS-R-42-M	30546839	CP-EAS-R-N2-M	30561489
2	BC-EAS-R-42-P	30546840	CP-EAS-R-N2-P	30561490
2	BC-EAS-R-42-R	30546841	CP-EAS-R-N2-R	30508277
3	BC-EAS-R-43-B	30546844	CP-EAS-R-N3-B	30561492
3	BC-EAS-R-43-D	30498067	CP-EAS-R-N3-D	30561493
3	BC-EAS-R-43-F	30503115	CP-EAS-R-N3-F	30561494
3	BC-EAS-R-43-H	30503116	CP-EAS-R-N3-H	30561495
3	BC-EAS-R-43-K	30546845	CP-EAS-R-N3-K	30561496
3	BC-EAS-R-43-M	30546846	CP-EAS-R-N3-M	30561497
3	BC-EAS-R-43-P	30546848	CP-EAS-R-N3-P	30561498
3	BC-EAS-R-43-R	30546849	CP-EAS-R-N3-R	30561499

Hinweis:

Bei Systemwechsel unbedingt beachten, dass Kassette und Spannplatte entsprechend angepasst werden müssen.



Schneidengröße HX	Messerkassetten für EasyAdjust-System		Klemmplatten für EasyAdjust-System	
	Spezifikation	Bestell-Nr.	Spezifikation	Bestell-Nr.
2	BC-EAS-R-62-B	30275903	CP-EAS-R-N2-B	30508276
2	BC-EAS-R-62-D	30410077	CP-EAS-R-N2-D	30561484
2	BC-EAS-R-62-F	30503094	CP-EAS-R-N2-F	30561485
2	BC-EAS-R-62-H	30503096	CP-EAS-R-N2-H	30561487
2	BC-EAS-R-62-K	30496821	CP-EAS-R-N2-K	30561488
2	BC-EAS-R-62-M	30471831	CP-EAS-R-N2-M	30561489
2	BC-EAS-R-62-P	30471833	CP-EAS-R-N2-P	30561490
2	BC-EAS-R-62-R	30496828	CP-EAS-R-N2-R	30508277
3	BC-EAS-R-63-B	30495992	CP-EAS-R-N3-B	30561492
3	BC-EAS-R-63-D	30469856	CP-EAS-R-N3-D	30561493
3	BC-EAS-R-63-F	30503097	CP-EAS-R-N3-F	30561494
3	BC-EAS-R-63-H	30503098	CP-EAS-R-N3-H	30561495
3	BC-EAS-R-63-K	30496827	CP-EAS-R-N3-K	30561496
3	BC-EAS-R-63-M	30471832	CP-EAS-R-N3-M	30561497
3	BC-EAS-R-63-P	30471834	CP-EAS-R-N3-P	30561498
3	BC-EAS-R-63-R	30496829	CP-EAS-R-N3-R	30561499

Schnittwertempfehlung für HX-Wendeschneidplatten

Vorschub und Schnittgeschwindigkeit

HX-HP342

MZG*	Werkstoff	Festigkeit/Härte [N/mm ²] [HRC]	Schnittgeschwindigkeit v _c (m/min)		Vorschub f _z (mm/u)
			Innen- kühlung	Außen- kühlung	
P P1	P1.1 Bau-, Automaten-, Einsatz- und Vergütungsstähle, unlegiert	< 700	80	40	0,150
	P1.2 Bau-, Automaten-, Einsatz- und Vergütungsstähle, unlegiert	< 1200	70	35	0,150

HX-HP122

MZG*	Werkstoff	Festigkeit/Härte [N/mm ²] [HRC]	Schnittgeschwindigkeit v _c (m/min)		Vorschub f _z (mm/u)
			Innen- kühlung	Außen- kühlung	
P P2 P3 P5	P2.1 Nitrier-, Einsatz- und Vergütungsstähle, legiert	< 900	100	50	0,150
	P2.2 Nitrier-, Einsatz- und Vergütungsstähle, legiert	< 1400	80	40	0,150
	P3.1 Werkzeug-, Wälzlager-, Feder- und Schnellarbeitsstähle**	< 900	100	50	0,150
	P3.2 Werkzeug-, Wälzlager-, Feder- und Schnellarbeitsstähle**	< 1500	80	40	0,150
	P5.1 Stahlguss		80	40	0,150

HX-HP018

MZG*	Werkstoff	Festigkeit/Härte [N/mm ²] [HRC]	Schnittgeschwindigkeit v _c (m/min)		Vorschub f _z (mm/u)
			Innen- kühlung	Außen- kühlung	
P4 P6	P4.1 Rostfreie Stähle, ferritisch und martensitisch		50	25	0,120
	P6.1 Rostfreier Stahlguss, ferritisch und martensitisch		40	20	0,120
M M1 M2 M3	M1.1 Rostfreie Stähle, austenitisch	< 700	50	25	0,120
	M1.2 Rostfreie Stähle, ferritisch/austenitisch (Duplex)	< 1000	30	15	0,120
	M2.1 Rostfreier Stahlguss, austenitisch	< 700	50	25	0,120
	M3.1 Rostfreier Stahlguss, ferritisch/austenitisch (Duplex)	< 1000	30	15	0,120

HX-HC419

MZG*	Werkstoff	Festigkeit/Härte [N/mm ²] [HRC]	Schnittgeschwindigkeit v _c (m/min)		Vorschub f _z (mm/u)
			Innen- kühlung	Außen- kühlung	
K K1	K1.1 Gusseisen mit Lamellengraphit (Grauguss), GJL	< 300	110	55	0,150

* MAPAL Zerspanungsgruppen

** Wenn die Legierungsbestandteile Cr, Mo, Ni, V, W in Summe > 8 %, dann die nächst höhere MAPAL Zerspanungsgruppe wählen.

HX-HP122

MZG*	Werkstoff	Festigkeit/Härte [N/mm ²] [HRC]	Schnittgeschwindigkeit v _c (m/min)		Vorschub f _z (mm/u)
			Innen- kühlung	Außen- kühlung	
K2	K2.1 Gusseisen mit Kugelgraphit, GJS	< 500	100	50	0,150
	K2.2 Gusseisen mit Kugelgraphit, GJS	≤ 800	90	45	0,150
	K2.3 Gusseisen mit Kugelgraphit, GJS	> 800	80	40	0,150
K3	K3.1 Gusseisen mit Vermiculargraphit, GJV; Temperguss, GJM	< 500	70	35	0,150
	K3.2 Gusseisen mit Vermiculargraphit, GJV; Temperguss, GJM	> 500	70	35	0,150

HX-HP612

MZG*	Werkstoff	Festigkeit/Härte [N/mm ²] [HRC]	Schnittgeschwindigkeit v _c (m/min)		Vorschub f _z (mm/u)
			Innen- kühlung	Außen- kühlung	
N N1	N1.1 Aluminium, unlegiert und legiert < 3 % Si		160	80	0,150
	N1.2 Aluminium, legiert ≤ 7 % Si		160	80	0,150

HX-HU612

MZG*	Werkstoff	Festigkeit/Härte [N/mm ²] [HRC]	Schnittgeschwindigkeit v _c (m/min)		Vorschub f _z (mm/u)
			Innen- kühlung	Außen- kühlung	
N N2	N2.1 Kupfer, unlegiert und niedriglegiert	< 300	100	50	0,150
	N2.2 Kupfer, legiert	> 300	100	50	0,150
	N2.3 Messing, Bronze, Rotguss	< 1200	100	50	0,150
S S1 S2	S1.1 Titan, Titanlegierungen	< 400	30	15	0,120
	S2.1 Titan, Titanlegierungen	< 1200	20	10	0,120
	S2.2 Titan, Titanlegierungen	> 1200	20	10	0,100

HX-HP018

MZG*	Werkstoff	Festigkeit/Härte [N/mm ²] [HRC]	Schnittgeschwindigkeit v _c (m/min)		Vorschub f _z (mm/u)
			Innen- kühlung	Außen- kühlung	
H H1 H1.1	Gehärteter Stahl/Stahlguss	45 - 55	30	15	0,120

Die angegebenen Schnittwerte sind Richtwerte.

Die für den jeweiligen Bearbeitungsfall optimalen Daten sollten im Versuch oder während der Bearbeitung ermittelt werden.

Schnittwertempfehlung für HX-Wendescheidplatten

Vorschub und Schnittgeschwindigkeit

HX-CP122

MZG*		Werkstoff	Festigkeit/Härte [N/mm ²] [HRC]	Schnittgeschwindigkeit v _c (m/min)		Vorschub f _z (mm/u)
				Innen- kühlung	Außen- kühlung	
P1	P1.1	Bau-, Automaten-, Einsatz- und Vergütungsstähle, unlegiert	< 700	180	90	0,150
	P1.2	Bau-, Automaten-, Einsatz- und Vergütungsstähle, unlegiert	< 1200	160	80	0,120
P2	P2.1	Nitrier-, Einsatz- und Vergütungsstähle, legiert	< 900	160	80	0,150
	P2.2	Nitrier-, Einsatz- und Vergütungsstähle, legiert	< 1400	140	70	0,120
P3	P3.1	Werkzeug-, Wälzlager-, Feder- und Schnellarbeitsstähle**	< 800	160	80	0,150
	P3.2	Werkzeug-, Wälzlager-, Feder- und Schnellarbeitsstähle**	< 1000	160	80	0,150
	P3.3	Werkzeug-, Wälzlager-, Feder- und Schnellarbeitsstähle**	< 1500	140	70	0,120
P5	P5.1	Stahlguss		140	70	0,120

HX-PU620

MZG*		Werkstoff	Festigkeit/Härte [N/mm ²] [HRC]	Schnittgeschwindigkeit v _c (m/min)		Vorschub f _z (mm/u)
				Innen- kühlung	Außen- kühlung	
N1	N1.1	Aluminium, unlegiert und legiert < 3 % Si		230	115	0,150
	N1.2	Aluminium, legiert ≤ 7 % Si		230	115	0,150
	N1.3	Aluminium, legiert > 7-12 % Si		230	115	0,150
	N1.4	Aluminium, legiert > 12 % Si		230	115	0,150
N2	N2.1	Kupfer, unlegiert und niedriglegiert	< 300	180	90	0,150
	N2.2	Kupfer, legiert	> 300	180	90	0,150
	N2.3	Messing, Bronze, Rotguss	< 1200	180	90	0,150

HX-FU485

MZG*		Werkstoff	Festigkeit/Härte [N/mm ²] [HRC]	Schnittgeschwindigkeit v _c (m/min)		Vorschub f _z (mm/u)	
				Innen- kühlung	Außen- kühlung		
K	K1	K1.1	Gusseisen mit Lamellengraphit (Grauguss), GJL	< 300	150	75	0,150

HX-FU801

MZG*		Werkstoff	Festigkeit/Härte [N/mm ²] [HRC]	Schnittgeschwindigkeit v _c (m/min)		Vorschub f _z (mm/u)	
				Innen- kühlung	Außen- kühlung		
H	H1	H1.1	Gehärteter Stahl/Stahlguss	45 - 55	60	30	0,100
		H1.2	Gehärteter Stahl/Stahlguss	55 - 64	50	25	0,080

* MAPAL Zerspanungsgruppen

** Wenn die Legierungsbestandteile Cr, Mo, Ni, V, W in Summe > 8 %, dann die nächst höhere MAPAL Zerspanungsgruppe wählen.

Schnittwertempfehlung für TEC-Wendescheidplatten

Vorschub und Schnittgeschwindigkeit

TEC2-AS-HP115

MZG*	Werkstoff	Festigkeit/Härte [N/mm ²] [HRC]	Schnittgeschwindigkeit v _c (m/min)		Vorschub f _z (mm/u)	
			Innen- kühlung	Außen- kühlung		
P P1	P1.1	Bau-, Automaten-, Einsatz- und Vergütungsstähle, unlegiert	< 700	80	40	0,150
	P1.2	Bau-, Automaten-, Einsatz- und Vergütungsstähle, unlegiert	< 1200	70	35	0,150

TEC2-EK-HP115

MZG*	Werkstoff	Festigkeit/Härte [N/mm ²] [HRC]	Schnittgeschwindigkeit v _c (m/min)		Vorschub f _z (mm/u)	
			Innen- kühlung	Außen- kühlung		
P P1	P1.1	Bau-, Automaten-, Einsatz- und Vergütungsstähle, unlegiert	< 700 N/mm ²	80	40	0,150
	P1.2	Bau-, Automaten-, Einsatz- und Vergütungsstähle, unlegiert	< 1200 N/mm ²	70	35	0,150

TEC2-DZ-HP115

MZG*	Werkstoff	Festigkeit/Härte [N/mm ²] [HRC]	Schnittgeschwindigkeit v _c (m/min)		Vorschub f _z (mm/u)	
			Innen- kühlung	Außen- kühlung		
P P1	P1.1	Bau-, Automaten-, Einsatz- und Vergütungsstähle, unlegiert	< 700	80	40	0,150
	P1.2	Bau-, Automaten-, Einsatz- und Vergütungsstähle, unlegiert	< 1200	70	35	0,150

TEC2-04-HP115

MZG*	Werkstoff	Festigkeit/Härte [N/mm ²] [HRC]	Schnittgeschwindigkeit v _c (m/min)		Vorschub f _z (mm/u)	
			Innen- kühlung	Außen- kühlung		
P P1	P1.1	Bau-, Automaten-, Einsatz- und Vergütungsstähle, unlegiert	< 700	80	40	0,150
	P1.2	Bau-, Automaten-, Einsatz- und Vergütungsstähle, unlegiert	< 1200	70	35	0,150

TEC2-AS-HP425

MZG*	Werkstoff	Festigkeit/Härte [N/mm ²] [HRC]	Schnittgeschwindigkeit v _c (m/min)		Vorschub f _z (mm/u)	
			Innen- kühlung	Außen- kühlung		
P P2 P3 P5	P2.1	Nitrier-, Einsatz- und Vergütungsstähle, legiert	< 900	100	50	0,150
	P2.2	Nitrier-, Einsatz- und Vergütungsstähle, legiert	< 1400	80	40	0,150
	P3.1	Werkzeug-, Wälzlager-, Feder- und Schnellarbeitsstähle**	< 900	100	50	0,150
	P3.2	Werkzeug-, Wälzlager-, Feder- und Schnellarbeitsstähle**	< 1500	80	40	0,150
	P5.1	Stahlguss		80	40	0,150

Die angegebenen Schnittwerte sind Richtwerte.

Die für den jeweiligen Bearbeitungsfall optimalen Daten sollten im Versuch oder während der Bearbeitung ermittelt werden.

Schnittwertempfehlung für TEC-Wendescheidplatten

Vorschub und Schnittgeschwindigkeit

TEC2-EK-HP425

MZG*		Werkstoff	Festigkeit/Härte [N/mm ²] [HRC]	Schnittgeschwindigkeit v _c (m/min)		Vorschub f _z (mm/u)
				Innen- kühlung	Außen- kühlung	
P	P2.1	Nitrier-, Einsatz- und Vergütungsstähle, legiert	< 900	100	50	0,150
	P2.2	Nitrier-, Einsatz- und Vergütungsstähle, legiert	< 1400	80	40	0,150
	P3.1	Werkzeug-, Wälzlager-, Feder- und Schnellarbeitsstähle**	< 900	100	50	0,150
	P3.2	Werkzeug-, Wälzlager-, Feder- und Schnellarbeitsstähle**	< 1500	80	40	0,150
	P5.1	Stahlguss		80	40	0,150

TEC2-DZ-HP425

MZG*		Werkstoff	Festigkeit/Härte [N/mm ²] [HRC]	Schnittgeschwindigkeit v _c (m/min)		Vorschub f _z (mm/u)
				Innen- kühlung	Außen- kühlung	
P	P2.1	Nitrier-, Einsatz- und Vergütungsstähle, legiert	< 900	100	50	0,150
	P2.2	Nitrier-, Einsatz- und Vergütungsstähle, legiert	< 1400	80	40	0,150
	P3.1	Werkzeug-, Wälzlager-, Feder- und Schnellarbeitsstähle**	< 900	100	50	0,150
	P3.2	Werkzeug-, Wälzlager-, Feder- und Schnellarbeitsstähle**	< 1500	80	40	0,150
	P5.1	Stahlguss		80	40	0,150

TEC2-04-HP425

MZG*		Werkstoff	Festigkeit/Härte [N/mm ²] [HRC]	Schnittgeschwindigkeit v _c (m/min)		Vorschub f _z (mm/u)
				Innen- kühlung	Außen- kühlung	
P	P2.1	Nitrier-, Einsatz- und Vergütungsstähle, legiert	< 900	100	50	0,150
	P2.2	Nitrier-, Einsatz- und Vergütungsstähle, legiert	< 1400	80	40	0,150
	P3.1	Werkzeug-, Wälzlager-, Feder- und Schnellarbeitsstähle**	< 900	100	50	0,150
	P3.2	Werkzeug-, Wälzlager-, Feder- und Schnellarbeitsstähle**	< 1500	80	40	0,150
	P5.1	Stahlguss		80	40	0,150

TEC2-AS-HP016

MZG*		Werkstoff	Festigkeit/Härte [N/mm ²] [HRC]	Schnittgeschwindigkeit v _c (m/min)		Vorschub f _z (mm/u)
				Innen- kühlung	Außen- kühlung	
P4	P4.1	Rostfreie Stähle, ferritisch und martensitisch		50	25	0,120
	P6.1	Rostfreier Stahlguss, ferritisch und martensitisch		40	20	0,120
M	M1.1	Rostfreie Stähle, austenitisch	< 700	50	25	0,120
	M1.2	Rostfreie Stähle, ferritisch/austenitisch (Duplex)	< 1000	30	15	0,120
	M2.1	Rostfreier Stahlguss, austenitisch	< 700	50	25	0,120
M3	M3.1	Rostfreier Stahlguss, ferritisch/austenitisch (Duplex)	< 1000	30	15	0,120

* MAPAL Zerspanungsgruppen

** Wenn die Legierungsbestandteile Cr, Mo, Ni, V, W in Summe > 8 %, dann die nächst höhere MAPAL Zerspanungsgruppe wählen.

TEC2-EK-HP016

MZG*	Werkstoff	Festigkeit/Härte [N/mm ²] [HRC]	Schnittgeschwindigkeit v _c (m/min)		Vorschub f _z (mm/u)	
			Innen- kühlung	Außen- kühlung		
P4	P4.1	Rostfreie Stähle, ferritisch und martensitisch	50	25	0,120	
P6	P6.1	Rostfreier Stahlguss, ferritisch und martensitisch	40	20	0,120	
M	M1.1	Rostfreie Stähle, austenitisch	< 700	50	25	0,120
	M1.2	Rostfreie Stähle, ferritisch/austenitisch (Duplex)	< 1000	30	15	0,120
	M2.1	Rostfreier Stahlguss, austenitisch	< 700	50	25	0,120
	M3.1	Rostfreier Stahlguss, ferritisch/austenitisch (Duplex)	< 1000	30	15	0,120

TEC2-DZ-HP016

MZG*	Werkstoff	Festigkeit/Härte [N/mm ²] [HRC]	Schnittgeschwindigkeit v _c (m/min)		Vorschub f _z (mm/u)	
			Innen- kühlung	Außen- kühlung		
P4	P4.1	Rostfreie Stähle, ferritisch und martensitisch	50	25	0,120	
P6	P6.1	Rostfreier Stahlguss, ferritisch und martensitisch	40	20	0,120	
M	M1.1	Rostfreie Stähle, austenitisch	< 700	50	25	0,120
	M1.2	Rostfreie Stähle, ferritisch/austenitisch (Duplex)	< 1000	30	15	0,120
	M2.1	Rostfreier Stahlguss, austenitisch	< 700	50	25	0,120
	M3.1	Rostfreier Stahlguss, ferritisch/austenitisch (Duplex)	< 1000	30	15	0,120

TEC2-04-HP016

MZG*	Werkstoff	Festigkeit/Härte [N/mm ²] [HRC]	Schnittgeschwindigkeit v _c (m/min)		Vorschub f _z (mm/u)	
			Innen- kühlung	Außen- kühlung		
P4	P4.1	Rostfreie Stähle, ferritisch und martensitisch	50	25	0,120	
P6	P6.1	Rostfreier Stahlguss, ferritisch und martensitisch	40	20	0,120	
M	M1.1	Rostfreie Stähle, austenitisch	< 700	50	25	0,120
	M1.2	Rostfreie Stähle, ferritisch/austenitisch (Duplex)	< 1000	30	15	0,120
	M2.1	Rostfreier Stahlguss, austenitisch	< 700	50	25	0,120
	M3.1	Rostfreier Stahlguss, ferritisch/austenitisch (Duplex)	< 1000	30	15	0,120

TEC2-DZ-HC418

MZG*	Werkstoff	Festigkeit/Härte [N/mm ²] [HRC]	Schnittgeschwindigkeit v _c (m/min)		Vorschub f _z (mm/u)		
			Innen- kühlung	Außen- kühlung			
K	K1	K1.1	Gusseisen mit Lamellengraphit (Grauguss), GJL	< 300	100	50	0,150

Die angegebenen Schnittwerte sind Richtwerte.

Die für den jeweiligen Bearbeitungsfall optimalen Daten sollten im Versuch oder während der Bearbeitung ermittelt werden.

Schnittwertempfehlung für TEC-Wendescheidplatten

Vorschub und Schnittgeschwindigkeit

TEC2-04-HC418

MZG*	Werkstoff	Festigkeit/Härte [N/mm ²] [HRC]	Schnittgeschwindigkeit v _c (m/min)		Vorschub f _z (mm/u)
			Innen- kühlung	Außen- kühlung	
K K1	K1.1 Gusseisen mit Lamellengraphit (Grauguss), GJL	< 300	100	50	0,150

TEC2-DZ-HP426

MZG*	Werkstoff	Festigkeit/Härte [N/mm ²] [HRC]	Schnittgeschwindigkeit v _c (m/min)		Vorschub f _z (mm/u)
			Innen- kühlung	Außen- kühlung	
K2	K2.1 Gusseisen mit Kugelgraphit, GJS	< 500	100	50	0,150
	K2.2 Gusseisen mit Kugelgraphit, GJS	≤ 800	90	45	0,150
	K2.3 Gusseisen mit Kugelgraphit, GJS	> 800	80	40	0,150
K3	K3.1 Gusseisen mit Vermiculargraphit, GJV; Temperguss, GJM	< 500	70	35	0,150
	K3.2 Gusseisen mit Vermiculargraphit, GJV; Temperguss, GJM	> 500	70	35	0,150

TEC2-04-HP426

MZG*	Werkstoff	Festigkeit/Härte [N/mm ²] [HRC]	Schnittgeschwindigkeit v _c (m/min)		Vorschub f _z (mm/u)
			Innen- kühlung	Außen- kühlung	
K2	K2.1 Gusseisen mit Kugelgraphit, GJS	< 500	100	50	0,150
	K2.2 Gusseisen mit Kugelgraphit, GJS	≤ 800	90	45	0,150
	K2.3 Gusseisen mit Kugelgraphit, GJS	> 800	80	40	0,150
K3	K3.1 Gusseisen mit Vermiculargraphit, GJV; Temperguss, GJM	< 500	70	35	0,150
	K3.2 Gusseisen mit Vermiculargraphit, GJV; Temperguss, GJM	> 500	70	35	0,150

TEC2-AS-HP612

MZG*	Werkstoff	Festigkeit/Härte [N/mm ²] [HRC]	Schnittgeschwindigkeit v _c (m/min)		Vorschub f _z (mm/u)
			Innen- kühlung	Außen- kühlung	
N N1	N1.1 Aluminium, unlegiert und legiert < 3 % Si		160	80	0,150
	N1.2 Aluminium, legiert ≤ 7 % Si		160	80	0,150

TEC2-EK-HP612

MZG*	Werkstoff	Festigkeit/Härte [N/mm ²] [HRC]	Schnittgeschwindigkeit v _c (m/min)		Vorschub f _z (mm/u)
			Innen- kühlung	Außen- kühlung	
N N1	N1.1 Aluminium, unlegiert und legiert < 3 % Si		160	80	0,150
	N1.2 Aluminium, legiert ≤ 7 % Si		160	80	0,150

TEC2-DZ-HP612

MZG*	Werkstoff	Festigkeit/Härte [N/mm ²] [HRC]	Schnittgeschwindigkeit v _c (m/min)		Vorschub f _z (mm/u)
			Innen- kühlung	Außen- kühlung	
N N1	N1.1 Aluminium, unlegiert und legiert < 3 % Si		160	80	0,150
	N1.2 Aluminium, legiert ≤ 7 % Si		160	80	0,150

TEC2-04-HP612

MZG*	Werkstoff	Festigkeit/Härte [N/mm ²] [HRC]	Schnittgeschwindigkeit v _c (m/min)		Vorschub f _z (mm/u)
			Innen- kühlung	Außen- kühlung	
N N1	N1.1 Aluminium, unlegiert und legiert < 3 % Si		160	80	0,150
	N1.2 Aluminium, legiert ≤ 7 % Si		160	80	0,150

TEC2-AS-HU615

MZG*	Werkstoff	Festigkeit/Härte [N/mm ²] [HRC]	Schnittgeschwindigkeit v _c (m/min)		Vorschub f _z (mm/u)
			Innen- kühlung	Außen- kühlung	
N N2	N2.1 Kupfer, unlegiert und niedriglegiert	< 300	100	50	0,150
	N2.2 Kupfer, legiert	> 300	100	50	0,150
	N2.3 Messing, Bronze, Rotguss	< 1200	100	50	0,150
S S1 S2	S1.1 Titan, Titanlegierungen	< 400	30	15	0,120
	S2.1 Titan, Titanlegierungen	< 1200	20	10	0,120
	S2.2 Titan, Titanlegierungen	> 1200	20	10	0,100

TEC2-EK-HU615

MZG*	Werkstoff	Festigkeit/Härte [N/mm ²] [HRC]	Schnittgeschwindigkeit v _c (m/min)		Vorschub f _z (mm/u)
			Innen- kühlung	Außen- kühlung	
N N2	N2.1 Kupfer, unlegiert und niedriglegiert	< 300	100	50	0,150
	N2.2 Kupfer, legiert	> 300	100	50	0,150
	N2.3 Messing, Bronze, Rotguss	< 1200	100	50	0,150
S S1 S2	S1.1 Titan, Titanlegierungen	< 400	30	15	0,120
	S2.1 Titan, Titanlegierungen	< 1200	20	10	0,120
	S2.2 Titan, Titanlegierungen	> 1200	20	10	0,100

Die angegebenen Schnittwerte sind Richtwerte.

Die für den jeweiligen Bearbeitungsfall optimalen Daten sollten im Versuch oder während der Bearbeitung ermittelt werden.

Schnittwertempfehlung für TEC-Wendescheidplatten

Vorschub und Schnittgeschwindigkeit

TEC2-DZ-HU615

MZG*			Werkstoff	Festigkeit/Härte [N/mm ²] [HRC]	Schnittgeschwindigkeit v _c (m/min)		Vorschub f _z (mm/u)
					Innen- kühlung	Außen- kühlung	
N	N2	N2.1	Kupfer, unlegiert und niedriglegiert	< 300	100	50	0,150
		N2.2	Kupfer, legiert	> 300	100	50	0,150
		N2.3	Messing, Bronze, Rotguss	< 1200	100	50	0,150
S	S1	S1.1	Titan, Titanlegierungen	< 400	30	15	0,120
		S2.1	Titan, Titanlegierungen	< 1200	20	10	0,120
		S2.2	Titan, Titanlegierungen	> 1200	20	10	0,100

TEC2-04-HU615

MZG*			Werkstoff	Festigkeit/Härte [N/mm ²] [HRC]	Schnittgeschwindigkeit v _c (m/min)		Vorschub f _z (mm/u)
					Innen- kühlung	Außen- kühlung	
N	N2	N2.1	Kupfer, unlegiert und niedriglegiert	< 300	100	50	0,150
		N2.2	Kupfer, legiert	> 300	100	50	0,150
		N2.3	Messing, Bronze, Rotguss	< 1200	100	50	0,150
S	S1	S1.1	Titan, Titanlegierungen	< 400	30	15	0,120
		S2.1	Titan, Titanlegierungen	< 1200	20	10	0,120
		S2.2	Titan, Titanlegierungen	> 1200	20	10	0,100

TEC2-DZ-HP016

MZG*			Werkstoff	Festigkeit/Härte [N/mm ²] [HRC]	Schnittgeschwindigkeit v _c (m/min)		Vorschub f _z (mm/u)
					Innen- kühlung	Außen- kühlung	
H	H1	H1.1	Gehärteter Stahl/Stahlguss	45 - 55	30	15	0,120

TEC2-04-HP016

MZG*			Werkstoff	Festigkeit/Härte [N/mm ²] [HRC]	Schnittgeschwindigkeit v _c (m/min)		Vorschub f _z (mm/u)
					Innen- kühlung	Außen- kühlung	
H	H1	H1.1	Gehärteter Stahl/Stahlguss	45 - 55	30	15	0,120

* MAPAL Zerspanungsgruppen

** Wenn die Legierungsbestandteile Cr, Mo, Ni, V, W in Summe > 8 %, dann die nächst höhere MAPAL Zerspanungsgruppe wählen.

TEC2-AS-CP122

MZG*	Werkstoff	Festigkeit/Härte [N/mm ²] [HRC]	Schnittgeschwindigkeit v _c (m/min)		Vorschub f _z (mm/u)	
			Innen- kühlung	Außen- kühlung		
P	P1.1	Bau-, Automaten-, Einsatz- und Vergütungsstähle, unlegiert	< 700	180	90	0,150
		Bau-, Automaten-, Einsatz- und Vergütungsstähle, unlegiert	< 1200	160	80	0,120
	P2.1	Nitrier-, Einsatz- und Vergütungsstähle, legiert	< 900	160	80	0,150
		Nitrier-, Einsatz- und Vergütungsstähle, legiert	< 1400	140	70	0,120
	P3.1	Werkzeug-, Wälzlager-, Feder- und Schnellarbeitsstähle**	< 800	160	80	0,150
		Werkzeug-, Wälzlager-, Feder- und Schnellarbeitsstähle**	< 1000	160	80	0,150
		Werkzeug-, Wälzlager-, Feder- und Schnellarbeitsstähle**	< 1500	140	70	0,120
	P5.1	Stahlguss		140	70	0,120

TEC2-EK-CP122

MZG*	Werkstoff	Festigkeit/Härte [N/mm ²] [HRC]	Schnittgeschwindigkeit v _c (m/min)		Vorschub f _z (mm/u)	
			Innen- kühlung	Außen- kühlung		
P	P1.1	Bau-, Automaten-, Einsatz- und Vergütungsstähle, unlegiert	< 700	180	90	0,150
		Bau-, Automaten-, Einsatz- und Vergütungsstähle, unlegiert	< 1200	160	80	0,120
	P2.1	Nitrier-, Einsatz- und Vergütungsstähle, legiert	< 900	160	80	0,150
		Nitrier-, Einsatz- und Vergütungsstähle, legiert	< 1400	140	70	0,120
	P3.1	Werkzeug-, Wälzlager-, Feder- und Schnellarbeitsstähle**	< 800	160	80	0,150
		Werkzeug-, Wälzlager-, Feder- und Schnellarbeitsstähle**	< 1000	160	80	0,150
		Werkzeug-, Wälzlager-, Feder- und Schnellarbeitsstähle**	< 1500	140	70	0,120
	P5.1	Stahlguss		140	70	0,120

TEC2-DZ-CP122

MZG*	Werkstoff	Festigkeit/Härte [N/mm ²] [HRC]	Schnittgeschwindigkeit v _c (m/min)		Vorschub f _z (mm/u)	
			Innen- kühlung	Außen- kühlung		
P	P1.1	Bau-, Automaten-, Einsatz- und Vergütungsstähle, unlegiert	< 700	180	90	0,150
		Bau-, Automaten-, Einsatz- und Vergütungsstähle, unlegiert	< 1200	160	80	0,120
	P2.1	Nitrier-, Einsatz- und Vergütungsstähle, legiert	< 900	160	80	0,150
		Nitrier-, Einsatz- und Vergütungsstähle, legiert	< 1400	140	70	0,120
	P3.1	Werkzeug-, Wälzlager-, Feder- und Schnellarbeitsstähle**	< 800	160	80	0,150
		Werkzeug-, Wälzlager-, Feder- und Schnellarbeitsstähle**	< 1000	160	80	0,150
		Werkzeug-, Wälzlager-, Feder- und Schnellarbeitsstähle**	< 1500	140	70	0,120
	P5.1	Stahlguss		140	70	0,120

Die angegebenen Schnittwerte sind Richtwerte.

Die für den jeweiligen Bearbeitungsfall optimalen Daten sollten im Versuch oder während der Bearbeitung ermittelt werden.

Schnittwertempfehlung für TEC-Wendescheidplatten

Vorschub und Schnittgeschwindigkeit

TEC2-04-CP122

MZG*	Werkstoff	Festigkeit/Härte [N/mm ²] [HRC]	Schnittgeschwindigkeit v _c (m/min)		Vorschub f _z (mm/u)	
			Innen- kühlung	Außen- kühlung		
P	P1.1	Bau-, Automaten-, Einsatz- und Vergütungsstähle, unlegiert	< 700	180	90	0,150
		Bau-, Automaten-, Einsatz- und Vergütungsstähle, unlegiert	< 1200	160	80	0,120
	P2.1	Nitrier-, Einsatz- und Vergütungsstähle, legiert	< 900	160	80	0,150
		Nitrier-, Einsatz- und Vergütungsstähle, legiert	< 1400	140	70	0,120
	P3.1	Werkzeug-, Wälzlager-, Feder- und Schnellarbeitsstähle**	< 800	160	80	0,150
		Werkzeug-, Wälzlager-, Feder- und Schnellarbeitsstähle**	< 1000	160	80	0,150
		Werkzeug-, Wälzlager-, Feder- und Schnellarbeitsstähle**	< 1500	140	70	0,120
	P5.1	Stahlguss		140	70	0,120

TEC2-AS-PU620

MZG*	Werkstoff	Festigkeit/Härte [N/mm ²] [HRC]	Schnittgeschwindigkeit v _c (m/min)		Vorschub f _z (mm/u)	
			Innen- kühlung	Außen- kühlung		
N	N1.1	Aluminium, unlegiert und legiert < 3 % Si		230	115	0,150
		Aluminium, legiert ≤ 7 % Si		230	115	0,150
		Aluminium, legiert > 7-12 % Si		230	115	0,150
		Aluminium, legiert > 12 % Si		230	115	0,150
	N2.1	Kupfer, unlegiert und niedriglegiert	< 300	180	90	0,150
		Kupfer, legiert	> 300	180	90	0,150
		Messing, Bronze, Rotguss	< 1200	180	90	0,150

TEC2-EK-PU620

MZG*	Werkstoff	Festigkeit/Härte [N/mm ²] [HRC]	Schnittgeschwindigkeit v _c (m/min)		Vorschub f _z (mm/u)	
			Innen- kühlung	Außen- kühlung		
N	N1.1	Aluminium, unlegiert und legiert < 3 % Si		230	115	0,150
		Aluminium, legiert ≤ 7 % Si		230	115	0,150
		Aluminium, legiert > 7-12 % Si		230	115	0,150
		Aluminium, legiert > 12 % Si		230	115	0,150
	N2.1	Kupfer, unlegiert und niedriglegiert	< 300	180	90	0,150
		Kupfer, legiert	> 300	180	90	0,150
		Messing, Bronze, Rotguss	< 1200	180	90	0,150

* MAPAL Zerspanungsgruppen

** Wenn die Legierungsbestandteile Cr, Mo, Ni, V, W in Summe > 8 %, dann die nächst höhere MAPAL Zerspanungsgruppe wählen.

TEC2-DZ-PU620

MZG*	Werkstoff	Festigkeit/Härte [N/mm ²] [HRC]	Schnittgeschwindigkeit v _c (m/min)		Vorschub f _z (mm/u)	
			Innen- kühlung	Außen- kühlung		
N	N1	N1.1 Aluminium, unlegiert und legiert < 3 % Si	230	115	0,150	
		N1.2 Aluminium, legiert ≤ 7 % Si	230	115	0,150	
		N1.3 Aluminium, legiert > 7-12 % Si	230	115	0,150	
		N1.4 Aluminium, legiert > 12 % Si	230	115	0,150	
N	N2	N2.1 Kupfer, unlegiert und niedriglegiert	< 300	180	90	0,150
		N2.2 Kupfer, legiert	> 300	180	90	0,150
		N2.3 Messing, Bronze, Rotguss	< 1200	180	90	0,150

TEC2-04-PU620

MZG*	Werkstoff	Festigkeit/Härte [N/mm ²] [HRC]	Schnittgeschwindigkeit v _c (m/min)		Vorschub f _z (mm/u)	
			Innen- kühlung	Außen- kühlung		
N	N1	N1.1 Aluminium, unlegiert und legiert < 3 % Si	230	115	0,150	
		N1.2 Aluminium, legiert ≤ 7 % Si	230	115	0,150	
		N1.3 Aluminium, legiert > 7-12 % Si	230	115	0,150	
		N1.4 Aluminium, legiert > 12 % Si	230	115	0,150	
N	N2	N2.1 Kupfer, unlegiert und niedriglegiert	< 300	180	90	0,150
		N2.2 Kupfer, legiert	> 300	180	90	0,150
		N2.3 Messing, Bronze, Rotguss	< 1200	180	90	0,150

Die angegebenen Schnittwerte sind Richtwerte.

Die für den jeweiligen Bearbeitungsfall optimalen Daten sollten im Versuch oder während der Bearbeitung ermittelt werden.

Schnittwertempfehlung für TEC-Wendescheidplatten

Vorschub und Schnittgeschwindigkeit

TEC2-DZ-FU485

MZG*	Werkstoff	Festigkeit/Härte [N/mm ²] [HRC]	Schnittgeschwindigkeit v_c (m/min)		Vorschub f_z (mm/u)
			Innen- kühlung	Außen- kühlung	
K K1 K1.1	Gusseisen mit Lamellengraphit (Grauguss), GJL	< 300	150	75	0,150

TEC2-04-FU485

MZG*	Werkstoff	Festigkeit/Härte [N/mm ²] [HRC]	Schnittgeschwindigkeit v_c (m/min)		Vorschub f_z (mm/u)
			Innen- kühlung	Außen- kühlung	
K K1 K1.1	Gusseisen mit Lamellengraphit (Grauguss), GJL	< 300	150	75	0,150

TEC2-DZ-FU801

MZG*		Werkstoff	Festigkeit/Härte [N/mm ²] [HRC]	Schnittgeschwindigkeit v _c (m/min)		Vorschub f _z (mm/u)	
				Innen- kühlung	Außen- kühlung		
H	H1	H1.1	Gehärteter Stahl/Stahlguss	45 - 55	60	30	0,100
	H1.2	Gehärteter Stahl/Stahlguss	55 - 64	50	25	0,080	

TEC2-04-FU801

MZG*		Werkstoff	Festigkeit/Härte [N/mm ²] [HRC]	Schnittgeschwindigkeit v _c (m/min)		Vorschub f _z (mm/u)	
				Innen- kühlung	Außen- kühlung		
H	H1	H1.1	Gehärteter Stahl/Stahlguss	45 - 55	60	30	0,100
		H1.2	Gehärteter Stahl/Stahlguss	55 - 64	50	25	0,080

Die angegebenen Schnittwerte sind Richtwerte.

Die für den jeweiligen Bearbeitungsfall optimalen Daten sollten im Versuch oder während der Bearbeitung ermittelt werden.



Einfaches Handling beim Außenreiben kleiner Durchmesser

Um das Einstellen von Außenreibahlen mit kleinen Durchmessern so einfach wie möglich zu gestalten, hat MAPAL ein neues System entwickelt. Das EasyAdjust-System ist dafür in eine Kassette integriert. Diese kann ausgebaut werden, um die Schneide mit Mikrometerschraube oder Messplatte schnell und einfach einzustellen.

Beim EA-System selbst ist die Verjüngung der Schneide bereits in die Aufnahme der Schneide integriert. Damit entfällt der Einstellvorgang für die Verjüngung der Nebenschneide komplett. Nur noch der Überstand der Schneide zu den Führungsleisten muss eingestellt werden. Dank hoher Wechselgenauigkeit sowie dem denkbar einfachen Einstellen der Schneide ist die prozesssichere Einhaltung der geforderten Toleranzen bei hochgenauen Passungen auch im kleinen Durchmesserbereich mit dem neuen System deutlich einfacher zu realisieren.

AUF EINEN BLICK

- Neues System für einfaches Einstellen beim Außenreiben kleiner Durchmesser
- Kassette des EA-Systems in eine weitere, ausbaubare Kassette integriert
- Hohe Wechselgenauigkeit (kleiner 2-3 μm)
- Schneide kann schnell und einfach eingestellt werden
- Verjüngung der Schneide ist in die Kassette, die als Aufnahme für die Schneide dient, integriert

VORTEILE

- Hohe Wirtschaftlichkeit und Prozesssicherheit
- Reduzierter Einstellaufwand durch innovative Kassette in Kassette
- Einfache Handhabung
- Einstellvorgang für die Verjüngung der Nebenschneide entfällt komplett
- Prozesssichere Einhaltung enger Toleranzen



Außenreibahle mit EasyAdjust-System | Systemunterscheidung

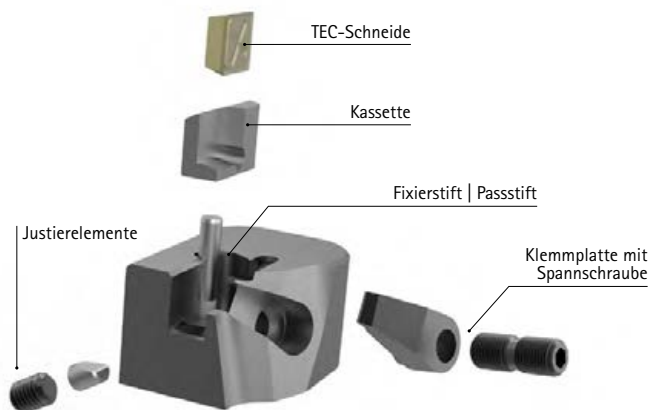

EasyAdjust-System mit TEC-Wendeschneidplatte

- Mehrschneidigkeit (Anzahl der Schneidkanten)
- Einfaches Handling
- Möglichkeit TEC2- und TEC3-Schneiden

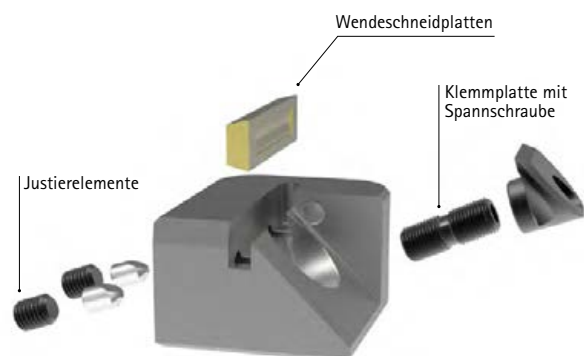

Wendeschneidplatten

- Hohe Anforderungen an die Oberfläche z. B. $< R_z 6$
- Spezielle Kontur (Wendeschneidplatten)
- Planbearbeitung
- Planschnitt mit Radiusübergang

TEC-Wendeschnidplatten für Außenbearbeitungswerkzeuge

Schneidstoff	Hartmetall								
MZG*	P				M	K	N		
	1.1 - 1.2	2 - 3 5	4 6	1 - 3	1.1	2 - 3	1.1 - 1.2	2.3	2.1 - 2.2
Schneidstoffsorte	HP115	HP425	HP016	HP016	HC418	HP426	HP612	HU615	

Span- formgeom.	Bau- größe	An- schnitt	Spezifikation	Bestell-Nr.							
neutral	2	AS	WP-TEC2-ASE02LOA-...								
		EK **	WP-TEC2-EKE02LOA-...								
		DZ	WP-TEC2-DZE02LOA-...					31306931			
		R0,4 **	WP-TEC2-04E02LOA-...					31306932			

positiv	2	AS	WP-TEC2-ASF01L1G-...	31306933	30889440	31079651	31079651			31140267	
		EK **	WP-TEC2-EKF01L1G-...	30653470	30829191	30971023	30971023			30630537	
		DZ	WP-TEC2-DZF01L1G-...	31306937	31306938	31306940	31306940		31306941	31181002	
		R0,4 **	WP-TEC2-04F01L1J-...	31306945	31306947	31306949	31306949		31306950	31306951	

hoch positiv	2	AS	WP-TEC2-ASF01L1N-...						31306973	31306974
		EK **	WP-TEC2-EKF01L1N-...						31306977	31306978
		DZ	WP-TEC2-DZF01L1N-...						31306979	31306980
		R0,4 **	WP-TEC2-04F01L1U-...						31306981	31306982

** Notiz: Anschnitt EK und R0,4 nur für die Bearbeitung von Grundbohrungen und bauteilbedingte Planbearbeitungen verwenden



Hartmetall			Cermet		PKD		PcBN	
S		H	P		N		K	H
1 - 2		1.1	1 - 3 5		1 - 2		1.1	1.1 - 1.2
HU615		HP016	CP122		PU620		FU485	FU801
Bestell-Nr.			Bestell-Nr.		Bestell-Nr.		Bestell-Nr.	
			31301539		31306934			
			30627301		30630446			
			31306942		31306943			
			31307406		31306953			
31306974								
31306978								
31306980								
31306982								

Wendeschnidplatten für Außenbearbeitungswerkzeuge

Schneidstoff	Hartmetall									
MZG*	P				M	K	N			
	1.1 - 1.2	2 - 3 5	4 6	1 - 3	1.1	2 - 3	1.1 - 1.2	2.3	2.1 - 2.2	
Schneidstoffsorte	HP115	HP425	HP016	HP016	HC418	HP426	HP612	HU615		

Span- formgeom.	Bau- größe	An- schnitt	Spezifikation	Bestell-Nr.								
neutral	92	AS	WP-AS92L0-...									
		EK	WP-EK152L0-...									
		DZ	WP-DZ92L0-...					31301508				

positiv	92	AS	WP-AS92L6-...	30914125	30914127	31056555	31056555				30914124	
		EK	WP-EK152L6-...	30914554	31302302	31247603	31247603				30914553	
		DZ	WP-DZ92L6-...	31306923	31306925	31306926	31306926		31306927		30914421	

hoch positiv	92	AS	WP-AS92L2-...							31175426		30914120
		EK	WP-EK152L2-...							31301535		30914549
		DZ	WP-DZ92L2-...									

Schneide mit
Anschnitt AS



Schneide mit
Anschnitt EK



Schneide mit
Anschnitt DZ



Hartmetall		
S		H
1 - 2		1.1
HU615		HP016

Cermet	
P	
1 - 3 5	
CP122	

PKD	
N	
1 - 2	
PU620	

PcBN		
K		H
1.1		1.1 - 1.2
FU485		FU801

Bestell-Nr.		

Bestell-Nr.	

Bestell-Nr.	

Bestell-Nr.		

30309015	
31301541	
31306928	

30914763	
30914788	

30914120		
30914549		

Zubehör für Außenbearbeitungswerkzeuge



Schneidengröße TEC	Messerkassetten für Aussenbearbeitungswerkzeug		Klemmplatten für Aussenbearbeitungswerkzeug	
	Spezifikation	Bestell-Nr.	Spezifikation	Bestell-Nr.
2	BC-EAS-L-42-B	30562954	CP-EAS-L-N2-B	30565468
2	BC-EAS-L-42-D	30558608	CP-EAS-L-N2-D	30560195
2	BC-EAS-L-42-F	30562956	CP-EAS-L-N2-F	30565469
2	BC-EAS-L-42-H	30562958	CP-EAS-L-N2-H	30565470
2	BC-EAS-L-42-K	30562959	CP-EAS-L-N2-K	30565472
2	BC-EAS-L-42-M	30562960	CP-EAS-L-N2-M	30565474
2	BC-EAS-L-42-P	30562963	CP-EAS-L-N2-P	30565475
2	BC-EAS-L-42-R	30562964	CP-EAS-L-N2-R	30565478
3	BC-EAS-L-43-B	30562965	CP-EAS-L-N3-B	30565479
3	BC-EAS-L-43-D	30562967	CP-EAS-L-N3-D	30565481
3	BC-EAS-L-43-F	30562968	CP-EAS-L-N3-F	30565483
3	BC-EAS-L-43-H	30562969	CP-EAS-L-N3-H	30565490
3	BC-EAS-L-43-K	30562970	CP-EAS-L-N3-K	30565491
3	BC-EAS-L-43-M	30562971	CP-EAS-L-N3-M	30565492
3	BC-EAS-L-43-P	30562972	CP-EAS-L-N3-P	30565494
3	BC-EAS-L-43-R	30562974	CP-EAS-L-N3-R	30565495

Hinweis:

Bei Systemwechsel unbedingt beachten, dass Kassette und Spannplatte entsprechend angepasst werden müssen.



Schnittwertempfehlung für Außenbearbeitungswerkzeuge mit TEC-Wendeschneidplatten

Vorschub und Schnittgeschwindigkeit

TEC2-AS-L-HP115

MZG*	Werkstoff	Festigkeit/Härte [N/mm ²] [HRC]	Schnittgeschwindigkeit v_c (m/min)	Vorschub f_z (mm/u)	
			Innenkühlung		
P P1	P1.1	Bau-, Automaten-, Einsatz- und Vergütungsstähle, unlegiert	< 700	80	0,150
	P1.2	Bau-, Automaten-, Einsatz- und Vergütungsstähle, unlegiert	< 1200	70	0,150

TEC2-EK-L-HP115

MZG*	Werkstoff	Festigkeit/Härte [N/mm ²] [HRC]	Schnittgeschwindigkeit v_c (m/min)	Vorschub f_z (mm/u)	
			Innenkühlung		
P P1	P1.1	Bau-, Automaten-, Einsatz- und Vergütungsstähle, unlegiert	< 700	80	0,150
	P1.2	Bau-, Automaten-, Einsatz- und Vergütungsstähle, unlegiert	< 1200	70	0,150

TEC2-DZ-L-HP115

MZG*	Werkstoff	Festigkeit/Härte [N/mm ²] [HRC]	Schnittgeschwindigkeit v_c (m/min)	Vorschub f_z (mm/u)	
			Innenkühlung		
P P1	P1.1	Bau-, Automaten-, Einsatz- und Vergütungsstähle, unlegiert	< 700	80	0,150
	P1.2	Bau-, Automaten-, Einsatz- und Vergütungsstähle, unlegiert	< 1200	70	0,150

TEC2-04-L-HP115

MZG*	Werkstoff	Festigkeit/Härte [N/mm ²] [HRC]	Schnittgeschwindigkeit v_c (m/min)	Vorschub f_z (mm/u)	
			Innenkühlung		
P P1	P1.1	Bau-, Automaten-, Einsatz- und Vergütungsstähle, unlegiert	< 700	80	0,150
	P1.2	Bau-, Automaten-, Einsatz- und Vergütungsstähle, unlegiert	< 1200	70	0,150

TEC2-AS-L-HP425

MZG*	Werkstoff	Festigkeit/Härte [N/mm ²] [HRC]	Schnittgeschwindigkeit v_c (m/min)	Vorschub f_z (mm/u)	
			Innenkühlung		
P P2 P3 P5	P2.1	Nitrier-, Einsatz- und Vergütungsstähle, legiert	< 900	100	0,150
	P2.2	Nitrier-, Einsatz- und Vergütungsstähle, legiert	< 1400	80	0,150
	P3.1	Werkzeug-, Wälzlager-, Feder- und Schnellarbeitsstähle**	< 900	100	0,150
	P3.2	Werkzeug-, Wälzlager-, Feder- und Schnellarbeitsstähle**	< 1500	80	0,150
	P5.1	Stahlguss		80	0,150

* MAPAL Zerspanungsgruppen

** Wenn die Legierungsbestandteile Cr, Mo, Ni, V, W in Summe > 8 %, dann die nächst höhere MAPAL Zerspanungsgruppe wählen.

TEC2-EK-L-HP425

MZG*	Werkstoff	Festigkeit/Härte [N/mm ²] [HRC]	Schnittgeschwindigkeit v_c (m/min)	Vorschub f_z (mm/u)	
			Innenkühlung		
P	P2.1	Nitrier-, Einsatz- und Vergütungsstähle, legiert	< 900	100	0,150
	P2.2	Nitrier-, Einsatz- und Vergütungsstähle, legiert	< 1400	80	0,150
	P3.1	Werkzeug-, Wälzlager-, Feder- und Schnellarbeitsstähle**	< 900	100	0,150
	P3.2	Werkzeug-, Wälzlager-, Feder- und Schnellarbeitsstähle**	< 1500	80	0,150
	P5.1	Stahlguss		80	0,150

TEC2-DZ-L-HP425

MZG*	Werkstoff	Festigkeit/Härte [N/mm ²] [HRC]	Schnittgeschwindigkeit v_c (m/min)	Vorschub f_z (mm/u)	
			Innenkühlung		
P	P2.1	Nitrier-, Einsatz- und Vergütungsstähle, legiert	< 900	100	0,150
	P2.2	Nitrier-, Einsatz- und Vergütungsstähle, legiert	< 1400	80	0,150
	P3.1	Werkzeug-, Wälzlager-, Feder- und Schnellarbeitsstähle**	< 900	100	0,150
	P3.2	Werkzeug-, Wälzlager-, Feder- und Schnellarbeitsstähle**	< 1500	80	0,150
	P5.1	Stahlguss		80	0,150

TEC2-04-L-HP425

MZG*	Werkstoff	Festigkeit/Härte [N/mm ²] [HRC]	Schnittgeschwindigkeit v_c (m/min)	Vorschub f_z (mm/u)	
			Innenkühlung		
P	P2.1	Nitrier-, Einsatz- und Vergütungsstähle, legiert	< 900	100	0,150
	P2.2	Nitrier-, Einsatz- und Vergütungsstähle, legiert	< 1400	80	0,150
	P3.1	Werkzeug-, Wälzlager-, Feder- und Schnellarbeitsstähle**	< 900	100	0,150
	P3.2	Werkzeug-, Wälzlager-, Feder- und Schnellarbeitsstähle**	< 1500	80	0,150
	P5.1	Stahlguss		80	0,150

TEC2-AS-L-HP016

MZG*	Werkstoff	Festigkeit/Härte [N/mm ²] [HRC]	Schnittgeschwindigkeit v_c (m/min)	Vorschub f_z (mm/u)	
			Innenkühlung		
P4	P4.1	Rostfreie Stähle, ferritisch und martensitisch	50	0,120	
P6	P6.1	Rostfreier Stahlguss, ferritisch und martensitisch	40	0,120	
M	M1.1	Rostfreie Stähle, austenitisch	< 700	50	0,120
	M1.2	Rostfreie Stähle, ferritisch/austenitisch (Duplex)	< 1000	30	0,120
	M2.1	Rostfreier Stahlguss, austenitisch	< 700	50	0,120
M3	M3.1	Rostfreier Stahlguss, ferritisch/austenitisch (Duplex)	< 1000	30	0,120

Die angegebenen Schnittwerte sind Richtwerte.

Die für den jeweiligen Bearbeitungsfall optimalen Daten sollten im Versuch oder während der Bearbeitung ermittelt werden.

Schnittwertempfehlung für Außenbearbeitungswerkzeuge mit TEC-Wendeschneidplatten

Vorschub und Schnittgeschwindigkeit

TEC2-EK-L-HP016

MZG*		Werkstoff	Festigkeit/Härte [N/mm ²] [HRC]	Schnittgeschwindigkeit v_c (m/min)	Vorschub f_z (mm/u)
				Innenkühlung	
P4	P4.1	Rostfreie Stähle, ferritisch und martensitisch		50	0,120
	P6	P6.1	Rostfreier Stahlguss, ferritisch und martensitisch	40	0,120
M	M1	M1.1	Rostfreie Stähle, austenitisch	< 700	50
		M1.2	Rostfreie Stähle, ferritisch/austenitisch (Duplex)	< 1000	30
	M2	M2.1	Rostfreier Stahlguss, austenitisch	< 700	50
	M3	M3.1	Rostfreier Stahlguss, ferritisch/austenitisch (Duplex)	< 1000	30

TEC2-DZ-L-HP016

MZG*		Werkstoff	Festigkeit/Härte [N/mm ²] [HRC]	Schnittgeschwindigkeit v_c (m/min)	Vorschub f_z (mm/u)
				Innenkühlung	
P4	P4.1	Rostfreie Stähle, ferritisch und martensitisch		50	0,120
	P6	P6.1	Rostfreier Stahlguss, ferritisch und martensitisch	40	0,120
M	M1	M1.1	Rostfreie Stähle, austenitisch	< 700	50
		M1.2	Rostfreie Stähle, ferritisch/austenitisch (Duplex)	< 1000	30
	M2	M2.1	Rostfreier Stahlguss, austenitisch	< 700	50
	M3	M3.1	Rostfreier Stahlguss, ferritisch/austenitisch (Duplex)	< 1000	30

TEC2-04-L-HP016

MZG*		Werkstoff	Festigkeit/Härte [N/mm ²] [HRC]	Schnittgeschwindigkeit v_c (m/min)	Vorschub f_z (mm/u)
				Innenkühlung	
P4	P4.1	Rostfreie Stähle, ferritisch und martensitisch		50	0,120
	P6	P6.1	Rostfreier Stahlguss, ferritisch und martensitisch	40	0,120
M	M1	M1.1	Rostfreie Stähle, austenitisch	< 700	50
		M1.2	Rostfreie Stähle, ferritisch/austenitisch (Duplex)	< 1000	30
	M2	M2.1	Rostfreier Stahlguss, austenitisch	< 700	50
	M3	M3.1	Rostfreier Stahlguss, ferritisch/austenitisch (Duplex)	< 1000	30

TEC2-DZ-L-HC418

MZG*		Werkstoff	Festigkeit/Härte [N/mm ²] [HRC]	Schnittgeschwindigkeit v_c (m/min)	Vorschub f_z (mm/u)
				Innenkühlung	
K	K1	K1.1	Gusseisen mit Lamellengraphit (Grauguss), GJL	< 300	100

TEC2-04-L-HC418

MZG*	Werkstoff	Festigkeit/Härte [N/mm ²] [HRC]	Schnittgeschwindigkeit v_c (m/min)	Vorschub f_z (mm/u)
			Innenkühlung	
K K1	K1.1 Gusseisen mit Lamellengraphit (Grauguss), GJL	< 300	100	0,150

TEC2-DZ-L-HP426

MZG*	Werkstoff	Festigkeit/Härte [N/mm ²] [HRC]	Schnittgeschwindigkeit v_c (m/min)	Vorschub f_z (mm/u)
			Innenkühlung	
K2	K2.1 Gusseisen mit Kugelgraphit, GJS	< 500	100	0,150
	K2.2 Gusseisen mit Kugelgraphit, GJS	≤ 800	90	0,150
	K2.3 Gusseisen mit Kugelgraphit, GJS	> 800	80	0,150
K3	K3.1 Gusseisen mit Vermiculargraphit, GJV; Temperguss, GJM	< 500	70	0,150
	K3.2 Gusseisen mit Vermiculargraphit, GJV; Temperguss, GJM	> 500	70	0,150

TEC2-04-L-HP426

MZG*	Werkstoff	Festigkeit/Härte [N/mm ²] [HRC]	Schnittgeschwindigkeit v_c (m/min)	Vorschub f_z (mm/u)
			Innenkühlung	
K2	K2.1 Gusseisen mit Kugelgraphit, GJS	< 500	100	0,150
	K2.2 Gusseisen mit Kugelgraphit, GJS	≤ 800	90	0,150
	K2.3 Gusseisen mit Kugelgraphit, GJS	> 800	80	0,150
K3	K3.1 Gusseisen mit Vermiculargraphit, GJV; Temperguss, GJM	< 500	70	0,150
	K3.2 Gusseisen mit Vermiculargraphit, GJV; Temperguss, GJM	> 500	70	0,150

TEC2-AS-L-HP612

MZG*	Werkstoff	Festigkeit/Härte [N/mm ²] [HRC]	Schnittgeschwindigkeit v_c (m/min)	Vorschub f_z (mm/u)
			Innenkühlung	
N N1	N1.1 Aluminium, unlegiert und legiert < 3 % Si		160	0,150
	N1.2 Aluminium, legiert ≤ 7 % Si		160	0,150

TEC2-EK-L-HP612

MZG*	Werkstoff	Festigkeit/Härte [N/mm ²] [HRC]	Schnittgeschwindigkeit v_c (m/min)	Vorschub f_z (mm/u)
			Innenkühlung	
N N1	N1.1 Aluminium, unlegiert und legiert < 3 % Si		160	0,150
	N1.2 Aluminium, legiert ≤ 7 % Si		160	0,150

Die angegebenen Schnittwerte sind Richtwerte.

Die für den jeweiligen Bearbeitungsfall optimalen Daten sollten im Versuch oder während der Bearbeitung ermittelt werden.

Schnittwertempfehlung für Außenbearbeitungswerkzeuge mit TEC-Wendeschneidplatten

Vorschub und Schnittgeschwindigkeit

TEC2-DZ-L-HP612

MZG*	Werkstoff	Festigkeit/Härte [N/mm ²] [HRC]	Schnittgeschwindigkeit v_c (m/min)	Vorschub f_z (mm/u)
			Innenkühlung	
N N1	N1.1 Aluminium, unlegiert und legiert < 3 % Si		160	0,150
	N1.2 Aluminium, legiert ≤ 7 % Si		160	0,150

TEC2-04-L-HP612

MZG*	Werkstoff	Festigkeit/Härte [N/mm ²] [HRC]	Schnittgeschwindigkeit v_c (m/min)	Vorschub f_z (mm/u)
			Innenkühlung	
N N1	N1.1 Aluminium, unlegiert und legiert < 3 % Si		160	0,150
	N1.2 Aluminium, legiert ≤ 7 % Si		160	0,150

TEC2-AS-L-HU615

MZG*	Werkstoff	Festigkeit/Härte [N/mm ²] [HRC]	Schnittgeschwindigkeit v_c (m/min)	Vorschub f_z (mm/u)
			Innenkühlung	
N N2	N2.1 Kupfer, unlegiert und niedriglegiert	< 300	100	0,150
	N2.2 Kupfer, legiert	> 300	100	0,150
	N2.3 Messing, Bronze, Rotguss	< 1200	100	0,150
S S1	S1.1 Titan, Titanlegierungen	< 400	30	0,120
	S2.1 Titan, Titanlegierungen	< 1200	20	0,120
	S2.2 Titan, Titanlegierungen	> 1200	20	0,100

TEC2-EK-L-HU615

MZG*	Werkstoff	Festigkeit/Härte [N/mm ²] [HRC]	Schnittgeschwindigkeit v_c (m/min)	Vorschub f_z (mm/u)
			Innenkühlung	
N N2	N2.1 Kupfer, unlegiert und niedriglegiert	< 300	100	0,150
	N2.2 Kupfer, legiert	> 300	100	0,150
	N2.3 Messing, Bronze, Rotguss	< 1200	100	0,150
S S1	S1.1 Titan, Titanlegierungen	< 400	30	0,120
	S2.1 Titan, Titanlegierungen	< 1200	20	0,120
	S2.2 Titan, Titanlegierungen	> 1200	20	0,100

* MAPAL Zerspanungsgruppen

** Wenn die Legierungsbestandteile Cr, Mo, Ni, V, W in Summe > 8 %, dann die nächst höhere MAPAL Zerspanungsgruppe wählen.

TEC2-DZ-L-HU615

MZG*		Werkstoff	Festigkeit/Härte [N/mm ²] [HRC]	Schnittgeschwindigkeit v_c (m/min)	Vorschub f_z (mm/u)	
				Innenkühlung		
N	N2	N2.1	Kupfer, unlegiert und niedriglegiert	< 300	100	0,150
		N2.2	Kupfer, legiert	> 300	100	0,150
		N2.3	Messing, Bronze, Rotguss	< 1200	100	0,150
S	S1	S1.1	Titan, Titanlegierungen	< 400	30	0,120
		S2.1	Titan, Titanlegierungen	< 1200	20	0,120
		S2.2	Titan, Titanlegierungen	> 1200	20	0,100

TEC2-04-L-HU615

MZG*		Werkstoff	Festigkeit/Härte [N/mm ²] [HRC]	Schnittgeschwindigkeit v_c (m/min)	Vorschub f_z (mm/u)	
				Innenkühlung		
N	N2	N2.1	Kupfer, unlegiert und niedriglegiert	< 300	100	0,150
		N2.2	Kupfer, legiert	> 300	100	0,150
		N2.3	Messing, Bronze, Rotguss	< 1200	100	0,150
S	S1	S1.1	Titan, Titanlegierungen	< 400	30	0,120
		S2.1	Titan, Titanlegierungen	< 1200	20	0,120
		S2.2	Titan, Titanlegierungen	> 1200	20	0,100

TEC2-AS-L-CP122

MZG*		Werkstoff	Festigkeit/Härte [N/mm ²] [HRC]	Schnittgeschwindigkeit v_c (m/min)	Vorschub f_z (mm/u)	
				Innenkühlung		
P1	P1	P1.1	Bau-, Automaten-, Einsatz- und Vergütungsstähle, unlegiert	< 700	180	0,150
		P1.2	Bau-, Automaten-, Einsatz- und Vergütungsstähle, unlegiert	< 1200	160	0,120
P2	P2	P2.1	Nitrier-, Einsatz- und Vergütungsstähle, legiert	< 900	160	0,150
		P2.2	Nitrier-, Einsatz- und Vergütungsstähle, legiert	< 1400	140	0,120
P3	P3	P3.1	Werkzeug-, Wälzlager-, Feder- und Schnellarbeitsstähle**	< 800	160	0,150
		P3.2	Werkzeug-, Wälzlager-, Feder- und Schnellarbeitsstähle**	< 1000	160	0,150
		P3.3	Werkzeug-, Wälzlager-, Feder- und Schnellarbeitsstähle**	< 1500	140	0,120
P5	P5.1	Stahlguss		140	0,120	

Die angegebenen Schnittwerte sind Richtwerte.

Die für den jeweiligen Bearbeitungsfall optimalen Daten sollten im Versuch oder während der Bearbeitung ermittelt werden.

Schnittwertempfehlung für Außenbearbeitungswerkzeuge mit TEC-Wendeschnidplatten

Vorschub und Schnittgeschwindigkeit

TEC2-EK-L-CP122

MZG*	Werkstoff	Festigkeit/Härte [N/mm ²] [HRC]	Schnittgeschwindigkeit v_c (m/min)	Vorschub f_z (mm/u)
			Innenkühlung	
P1	P1.1 Bau-, Automaten-, Einsatz- und Vergütungsstähle, unlegiert	< 700	180	0,150
	P1.2 Bau-, Automaten-, Einsatz- und Vergütungsstähle, unlegiert	< 1200	160	0,120
P2	P2.1 Nitrier-, Einsatz- und Vergütungsstähle, legiert	< 900	160	0,150
	P2.2 Nitrier-, Einsatz- und Vergütungsstähle, legiert	< 1400	140	0,120
P3	P3.1 Werkzeug-, Wälzlager-, Feder- und Schnellarbeitsstähle**	< 800	160	0,150
	P3.2 Werkzeug-, Wälzlager-, Feder- und Schnellarbeitsstähle**	< 1000	160	0,150
	P3.3 Werkzeug-, Wälzlager-, Feder- und Schnellarbeitsstähle**	< 1500	140	0,120
P5	P5.1 Stahlguss		140	0,120

TEC2-DZ-L-CP122

MZG*	Werkstoff	Festigkeit/Härte [N/mm ²] [HRC]	Schnittgeschwindigkeit v_c (m/min)	Vorschub f_z (mm/u)
			Innenkühlung	
P1	P1.1 Bau-, Automaten-, Einsatz- und Vergütungsstähle, unlegiert	< 700	180	0,150
	P1.2 Bau-, Automaten-, Einsatz- und Vergütungsstähle, unlegiert	< 1200	160	0,120
P2	P2.1 Nitrier-, Einsatz- und Vergütungsstähle, legiert	< 900	160	0,150
	P2.2 Nitrier-, Einsatz- und Vergütungsstähle, legiert	< 1400	140	0,120
P3	P3.1 Werkzeug-, Wälzlager-, Feder- und Schnellarbeitsstähle**	< 800	160	0,150
	P3.2 Werkzeug-, Wälzlager-, Feder- und Schnellarbeitsstähle**	< 1000	160	0,150
	P3.3 Werkzeug-, Wälzlager-, Feder- und Schnellarbeitsstähle**	< 1500	140	0,120
P5	P5.1 Stahlguss		140	0,120

TEC2-04-L-CP122

MZG*	Werkstoff	Festigkeit/Härte [N/mm ²] [HRC]	Schnittgeschwindigkeit v_c (m/min)	Vorschub f_z (mm/u)
			Innenkühlung	
P1	P1.1 Bau-, Automaten-, Einsatz- und Vergütungsstähle, unlegiert	< 700	180	0,150
	P1.2 Bau-, Automaten-, Einsatz- und Vergütungsstähle, unlegiert	< 1200	160	0,120
P2	P2.1 Nitrier-, Einsatz- und Vergütungsstähle, legiert	< 900	160	0,150
	P2.2 Nitrier-, Einsatz- und Vergütungsstähle, legiert	< 1400	140	0,120
P3	P3.1 Werkzeug-, Wälzlager-, Feder- und Schnellarbeitsstähle**	< 800	160	0,150
	P3.2 Werkzeug-, Wälzlager-, Feder- und Schnellarbeitsstähle**	< 1000	160	0,150
	P3.3 Werkzeug-, Wälzlager-, Feder- und Schnellarbeitsstähle**	< 1500	140	0,120
P5	P5.1 Stahlguss		140	0,120

* MAPAL Zerspanungsgruppen

** Wenn die Legierungsbestandteile Cr, Mo, Ni, V, W in Summe > 8 %, dann die nächst höhere MAPAL Zerspanungsgruppe wählen.

TEC2-AS-L-PU620

MZG*	Werkstoff	Festigkeit/Härte [N/mm ²] [HRC]	Schnittgeschwindigkeit v _c (m/min)	Vorschub f _z (mm/u)
			Innenkühlung	
N	N1	N1.1 Aluminium, unlegiert und legiert < 3 % Si	230	0,150
		N1.2 Aluminium, legiert ≤ 7 % Si	230	0,150
		N1.3 Aluminium, legiert > 7-12 % Si	230	0,150
		N1.4 Aluminium, legiert > 12 % Si	230	0,150
N	N2	N2.1 Kupfer, unlegiert und niedriglegiert	< 300	180
		N2.2 Kupfer, legiert	> 300	180
		N2.3 Messing, Bronze, Rotguss	< 1200	180

TEC2-EK-L-PU620

MZG*	Werkstoff	Festigkeit/Härte [N/mm ²] [HRC]	Schnittgeschwindigkeit v _c (m/min)	Vorschub f _z (mm/u)
			Innenkühlung	
N	N1	N1.1 Aluminium, unlegiert und legiert < 3 % Si	230	0,150
		N1.2 Aluminium, legiert ≤ 7 % Si	230	0,150
		N1.3 Aluminium, legiert > 7-12 % Si	230	0,150
		N1.4 Aluminium, legiert > 12 % Si	230	0,150
N	N2	N2.1 Kupfer, unlegiert und niedriglegiert	< 300	180
		N2.2 Kupfer, legiert	> 300	180
		N2.3 Messing, Bronze, Rotguss	< 1200	180

TEC2-DZ-L-PU620

MZG*	Werkstoff	Festigkeit/Härte [N/mm ²] [HRC]	Schnittgeschwindigkeit v _c (m/min)	Vorschub f _z (mm/u)
			Innenkühlung	
N	N1	N1.1 Aluminium, unlegiert und legiert < 3 % Si	230	0,150
		N1.2 Aluminium, legiert ≤ 7 % Si	230	0,150
		N1.3 Aluminium, legiert > 7-12 % Si	230	0,150
		N1.4 Aluminium, legiert > 12 % Si	230	0,150
N	N2	N2.1 Kupfer, unlegiert und niedriglegiert	< 300	180
		N2.2 Kupfer, legiert	> 300	180
		N2.3 Messing, Bronze, Rotguss	< 1200	180

TEC2-04-L-PU620

MZG*	Werkstoff	Festigkeit/Härte [N/mm ²] [HRC]	Schnittgeschwindigkeit v _c (m/min)	Vorschub f _z (mm/u)
			Innenkühlung	
N	N1	N1.1 Aluminium, unlegiert und legiert < 3 % Si	230	0,150
		N1.2 Aluminium, legiert ≤ 7 % Si	230	0,150
		N1.3 Aluminium, legiert > 7-12 % Si	230	0,150
		N1.4 Aluminium, legiert > 12 % Si	230	0,150
N	N2	N2.1 Kupfer, unlegiert und niedriglegiert	< 300	180
		N2.2 Kupfer, legiert	> 300	180
		N2.3 Messing, Bronze, Rotguss	< 1200	180

Die angegebenen Schnittwerte sind Richtwerte.

Die für den jeweiligen Bearbeitungsfall optimalen Daten sollten im Versuch oder während der Bearbeitung ermittelt werden.

Schnittwertempfehlung für Außenbearbeitungswerkzeuge mit Wendeschneidplatten

Vorschub und Schnittgeschwindigkeit

AS-L-HP115

MZG*	Werkstoff	Festigkeit/Härte [N/mm ²] [HRC]	Schnittgeschwindigkeit v_c (m/min)	Vorschub f_z (mm/u)	
			Innenkühlung		
P P1	P1.1	Bau-, Automaten-, Einsatz- und Vergütungsstähle, unlegiert	< 700	80	0,150
	P1.2	Bau-, Automaten-, Einsatz- und Vergütungsstähle, unlegiert	< 1200	70	0,150

EK-L-HP115

MZG*	Werkstoff	Festigkeit/Härte [N/mm ²] [HRC]	Schnittgeschwindigkeit v_c (m/min)	Vorschub f_z (mm/u)	
			Innenkühlung		
P P1	P1.1	Bau-, Automaten-, Einsatz- und Vergütungsstähle, unlegiert	< 700	80	0,150
	P1.2	Bau-, Automaten-, Einsatz- und Vergütungsstähle, unlegiert	< 1200	70	0,150

DZ-L-HP115

MZG*	Werkstoff	Festigkeit/Härte [N/mm ²] [HRC]	Schnittgeschwindigkeit v_c (m/min)	Vorschub f_z (mm/u)	
			Innenkühlung		
P P1	P1.1	Bau-, Automaten-, Einsatz- und Vergütungsstähle, unlegiert	< 700	80	0,150
	P1.2	Bau-, Automaten-, Einsatz- und Vergütungsstähle, unlegiert	< 1200	70	0,150

AS-L-HP425

MZG*	Werkstoff	Festigkeit/Härte [N/mm ²] [HRC]	Schnittgeschwindigkeit v_c (m/min)	Vorschub f_z (mm/u)		
			Innenkühlung			
P	P2	P2.1	Nitrier-, Einsatz- und Vergütungsstähle, legiert	< 900	100	0,150
		P2.2	Nitrier-, Einsatz- und Vergütungsstähle, legiert	< 1400	80	0,150
	P3	P3.1	Werkzeug-, Wälzlager-, Feder- und Schnellarbeitsstähle**	< 900	100	0,150
		P3.2	Werkzeug-, Wälzlager-, Feder- und Schnellarbeitsstähle**	< 1500	80	0,150
	P5	P5.1	Stahlguss		80	0,150

* MAPAL Zerspanungsgruppen

** Wenn die Legierungsbestandteile Cr, Mo, Ni, V, W in Summe > 8 %, dann die nächst höhere MAPAL Zerspanungsgruppe wählen.

EK-L-HP425

MZG*	Werkstoff	Festigkeit/Härte [N/mm ²] [HRC]	Schnittgeschwindigkeit v_c (m/min)	Vorschub f_z (mm/u)	
			Innenkühlung		
P	P2.1	Nitrier-, Einsatz- und Vergütungsstähle, legiert	< 900	100	0,150
	P2.2	Nitrier-, Einsatz- und Vergütungsstähle, legiert	< 1400	80	0,150
	P3.1	Werkzeug-, Wälzlager-, Feder- und Schnellarbeitsstähle**	< 900	100	0,150
	P3.2	Werkzeug-, Wälzlager-, Feder- und Schnellarbeitsstähle**	< 1500	80	0,150
	P5.1	Stahlguss		80	0,150

DZ-L-HP425

MZG*	Werkstoff	Festigkeit/Härte [N/mm ²] [HRC]	Schnittgeschwindigkeit v_c (m/min)	Vorschub f_z (mm/u)	
			Innenkühlung		
P	P2.1	Nitrier-, Einsatz- und Vergütungsstähle, legiert	< 900	100	0,150
	P2.2	Nitrier-, Einsatz- und Vergütungsstähle, legiert	< 1400	80	0,150
	P3.1	Werkzeug-, Wälzlager-, Feder- und Schnellarbeitsstähle**	< 900	100	0,150
	P3.2	Werkzeug-, Wälzlager-, Feder- und Schnellarbeitsstähle**	< 1500	80	0,150
	P5.1	Stahlguss		80	0,150

AS-L-HP016

MZG*	Werkstoff	Festigkeit/Härte [N/mm ²] [HRC]	Schnittgeschwindigkeit v_c (m/min)	Vorschub f_z (mm/u)	
			Innenkühlung		
P4	P4.1	Rostfreie Stähle, ferritisch und martensitisch		50	0,120
	P6.1	Rostfreier Stahlguss, ferritisch und martensitisch		40	0,120
M	M1.1	Rostfreie Stähle, austenitisch	< 700	50	0,120
	M1.2	Rostfreie Stähle, ferritisch/austenitisch (Duplex)	< 1000	30	0,120
	M2.1	Rostfreier Stahlguss, austenitisch	< 700	50	0,120
	M3.1	Rostfreier Stahlguss, ferritisch/austenitisch (Duplex)	< 1000	30	0,120

EK-L-HP016

MZG*	Werkstoff	Festigkeit/Härte [N/mm ²] [HRC]	Schnittgeschwindigkeit v_c (m/min)	Vorschub f_z (mm/u)	
			Innenkühlung		
P4	P4.1	Rostfreie Stähle, ferritisch und martensitisch		50	0,120
	P6.1	Rostfreier Stahlguss, ferritisch und martensitisch		40	0,120
M	M1.1	Rostfreie Stähle, austenitisch	< 700	50	0,120
	M1.2	Rostfreie Stähle, ferritisch/austenitisch (Duplex)	< 1000	30	0,120
	M2.1	Rostfreier Stahlguss, austenitisch	< 700	50	0,120
	M3.1	Rostfreier Stahlguss, ferritisch/austenitisch (Duplex)	< 1000	30	0,120

Die angegebenen Schnittwerte sind Richtwerte.

Die für den jeweiligen Bearbeitungsfall optimalen Daten sollten im Versuch oder während der Bearbeitung ermittelt werden.

Schnittwertempfehlung für Außenbearbeitungswerkzeuge mit Wendeschneidplatten

Vorschub und Schnittgeschwindigkeit

DZ-L-HP016

MZG*	Werkstoff	Festigkeit/Härte [N/mm ²] [HRC]	Schnittgeschwindigkeit v _c (m/min)	Vorschub f _z (mm/u)
			Innenkühlung	
P4	P4.1	Rostfreie Stähle, ferritisch und martensitisch	50	0,120
	P6.1	Rostfreier Stahlguss, ferritisch und martensitisch	40	0,120
M	M1.1	Rostfreie Stähle, austenitisch	< 700	0,120
	M1.2	Rostfreie Stähle, ferritisch/austenitisch (Duplex)	< 1000	0,120
	M2.1	Rostfreier Stahlguss, austenitisch	< 700	0,120
	M3.1	Rostfreier Stahlguss, ferritisch/austenitisch (Duplex)	< 1000	0,120

DZ-L-HC418

MZG*	Werkstoff	Festigkeit/Härte [N/mm ²] [HRC]	Schnittgeschwindigkeit v _c (m/min)	Vorschub f _z (mm/u)
			Innenkühlung	
K	K1.1	Gusseisen mit Lamellengraphit (Grauguss), GJL	< 300	0,150

DZ-L-HP426

MZG*	Werkstoff	Festigkeit/Härte [N/mm ²] [HRC]	Schnittgeschwindigkeit v _c (m/min)	Vorschub f _z (mm/u)
			Innenkühlung	
K2	K2.1	Gusseisen mit Kugelgraphit, GJS	< 500	0,150
	K2.2	Gusseisen mit Kugelgraphit, GJS	≤ 800	0,150
	K2.3	Gusseisen mit Kugelgraphit, GJS	> 800	0,150
K3	K3.1	Gusseisen mit Vermiculargraphit, GJV; Temperguss, GJM	< 500	0,150
	K3.2	Gusseisen mit Vermiculargraphit, GJV; Temperguss, GJM	> 500	0,150

AS-L-HP612

MZG*	Werkstoff	Festigkeit/Härte [N/mm ²] [HRC]	Schnittgeschwindigkeit v _c (m/min)	Vorschub f _z (mm/u)
			Innenkühlung	
N	N1.1	Aluminium, unlegiert und legiert < 3 % Si	160	0,150
	N1.2	Aluminium, legiert ≤ 7 % Si	160	0,150

EK-L-HP612

MZG*	Werkstoff	Festigkeit/Härte [N/mm ²] [HRC]	Schnittgeschwindigkeit v _c (m/min)	Vorschub f _z (mm/u)
			Innenkühlung	
N	N1.1	Aluminium, unlegiert und legiert < 3 % Si	160	0,150
	N1.2	Aluminium, legiert ≤ 7 % Si	160	0,150

* MAPAL Zerspanungsgruppen

AS-L-HU615

MZG*		Werkstoff	Festigkeit/Härte [N/mm ²] [HRC]	Schnittgeschwindigkeit v_c (m/min)	Vorschub f_z (mm/u)	
				Innenkühlung		
N	N2	N2.1	Kupfer, unlegiert und niedriglegiert	< 300	100	0,150
		N2.2	Kupfer, legiert	> 300	100	0,150
		N2.3	Messing, Bronze, Rotguss	< 1200	100	0,150
S	S1	S1.1	Titan, Titanlegierungen	< 400	30	0,120
		S2.1	Titan, Titanlegierungen	< 1200	20	0,120
		S2.2	Titan, Titanlegierungen	> 1200	20	0,100

EK-L-HU615

MZG*		Werkstoff	Festigkeit/Härte [N/mm ²] [HRC]	Schnittgeschwindigkeit v_c (m/min)	Vorschub f_z (mm/u)	
				Innenkühlung		
N	N2	N2.1	Kupfer, unlegiert und niedriglegiert	< 300	100	0,150
		N2.2	Kupfer, legiert	> 300	100	0,150
		N2.3	Messing, Bronze, Rotguss	< 1200	100	0,150
S	S1	S1.1	Titan, Titanlegierungen	< 400	30	0,120
		S2.1	Titan, Titanlegierungen	< 1200	20	0,120
		S2.2	Titan, Titanlegierungen	> 1200	20	0,100

DZ-L-HU615

MZG*		Werkstoff	Festigkeit/Härte [N/mm ²] [HRC]	Schnittgeschwindigkeit v_c (m/min)	Vorschub f_z (mm/u)	
				Innenkühlung		
N	N2	N2.1	Kupfer, unlegiert und niedriglegiert	< 300	100	0,150
		N2.2	Kupfer, legiert	> 300	100	0,150
		N2.3	Messing, Bronze, Rotguss	< 1200	100	0,150

Die angegebenen Schnittwerte sind Richtwerte.

Die für den jeweiligen Bearbeitungsfall optimalen Daten sollten im Versuch oder während der Bearbeitung ermittelt werden.

Schnittwertempfehlung für Außenbearbeitungswerkzeuge mit Wendeschneidplatten

Vorschub und Schnittgeschwindigkeit

AS-L-CP122

MZG*	Werkstoff	Festigkeit/Härte [N/mm ²] [HRC]	Schnittgeschwindigkeit v_c (m/min)	Vorschub f_z (mm/u)	
			Innenkühlung		
P	P1.1	Bau-, Automaten-, Einsatz- und Vergütungsstähle, unlegiert	< 700	180	0,150
		Bau-, Automaten-, Einsatz- und Vergütungsstähle, unlegiert	< 1200	160	0,120
	P2.1	Nitrier-, Einsatz- und Vergütungsstähle, legiert	< 900	160	0,150
		Nitrier-, Einsatz- und Vergütungsstähle, legiert	< 1400	140	0,120
	P3.1	Werkzeug-, Wälzlager-, Feder- und Schnellarbeitsstähle**	< 800	160	0,150
		Werkzeug-, Wälzlager-, Feder- und Schnellarbeitsstähle**	< 1000	160	0,150
		Werkzeug-, Wälzlager-, Feder- und Schnellarbeitsstähle**	< 1500	140	0,120
	P5.1	Stahlguss		140	0,120

EK-L-CP122

MZG*	Werkstoff	Festigkeit/Härte [N/mm ²] [HRC]	Schnittgeschwindigkeit v_c (m/min)	Vorschub f_z (mm/u)	
			Innenkühlung		
P	P1.1	Bau-, Automaten-, Einsatz- und Vergütungsstähle, unlegiert	< 700	180	0,150
		Bau-, Automaten-, Einsatz- und Vergütungsstähle, unlegiert	< 1200	160	0,120
	P2.1	Nitrier-, Einsatz- und Vergütungsstähle, legiert	< 900	160	0,150
		Nitrier-, Einsatz- und Vergütungsstähle, legiert	< 1400	140	0,120
	P3.1	Werkzeug-, Wälzlager-, Feder- und Schnellarbeitsstähle**	< 800	160	0,150
		Werkzeug-, Wälzlager-, Feder- und Schnellarbeitsstähle**	< 1000	160	0,150
		Werkzeug-, Wälzlager-, Feder- und Schnellarbeitsstähle**	< 1500	140	0,120
	P5.1	Stahlguss		140	0,120

DZ-L-CP122

MZG*	Werkstoff	Festigkeit/Härte [N/mm ²] [HRC]	Schnittgeschwindigkeit v_c (m/min)	Vorschub f_z (mm/u)	
			Innenkühlung		
P	P1.1	Bau-, Automaten-, Einsatz- und Vergütungsstähle, unlegiert	< 700	180	0,150
		Bau-, Automaten-, Einsatz- und Vergütungsstähle, unlegiert	< 1200	160	0,120
	P2.1	Nitrier-, Einsatz- und Vergütungsstähle, legiert	< 900	160	0,150
		Nitrier-, Einsatz- und Vergütungsstähle, legiert	< 1400	140	0,120
	P3.1	Werkzeug-, Wälzlager-, Feder- und Schnellarbeitsstähle**	< 800	160	0,150
		Werkzeug-, Wälzlager-, Feder- und Schnellarbeitsstähle**	< 1000	160	0,150
		Werkzeug-, Wälzlager-, Feder- und Schnellarbeitsstähle**	< 1500	140	0,120
	P5.1	Stahlguss		140	0,120

* MAPAL Zerspanungsgruppen

** Wenn die Legierungsbestandteile Cr, Mo, Ni, V, W in Summe > 8 %, dann die nächst höhere MAPAL Zerspanungsgruppe wählen.

AS-L-PU620

MZG*	Werkstoff	Festigkeit/Härte [N/mm ²] [HRC]	Schnittgeschwindigkeit v_c (m/min)	Vorschub f_z (mm/u)	
			Innenkühlung		
N	N1	N1.1 Aluminium, unlegiert und legiert < 3 % Si	230	0,150	
		N1.2 Aluminium, legiert ≤ 7 % Si	230	0,150	
		N1.3 Aluminium, legiert > 7-12 % Si	230	0,150	
		N1.4 Aluminium, legiert > 12 % Si	230	0,150	
	N2	N2.1 Kupfer, unlegiert und niedriglegiert	< 300	180	0,150
		N2.2 Kupfer, legiert	> 300	180	0,150
		N2.3 Messing, Bronze, Rotguss	< 1200	180	0,150

EK-L-PU620

MZG*	Werkstoff	Festigkeit/Härte [N/mm ²] [HRC]	Schnittgeschwindigkeit v_c (m/min)	Vorschub f_z (mm/u)	
			Innenkühlung		
N	N1	N1.1 Aluminium, unlegiert und legiert < 3 % Si	230	0,150	
		N1.2 Aluminium, legiert ≤ 7 % Si	230	0,150	
		N1.3 Aluminium, legiert > 7-12 % Si	230	0,150	
		N1.4 Aluminium, legiert > 12 % Si	230	0,150	
	N2	N2.1 Kupfer, unlegiert und niedriglegiert	< 300	180	0,150
		N2.2 Kupfer, legiert	> 300	180	0,150
		N2.3 Messing, Bronze, Rotguss	< 1200	180	0,150

Die angegebenen Schnittwerte sind Richtwerte.

Die für den jeweiligen Bearbeitungsfall optimalen Daten sollten im Versuch oder während der Bearbeitung ermittelt werden.

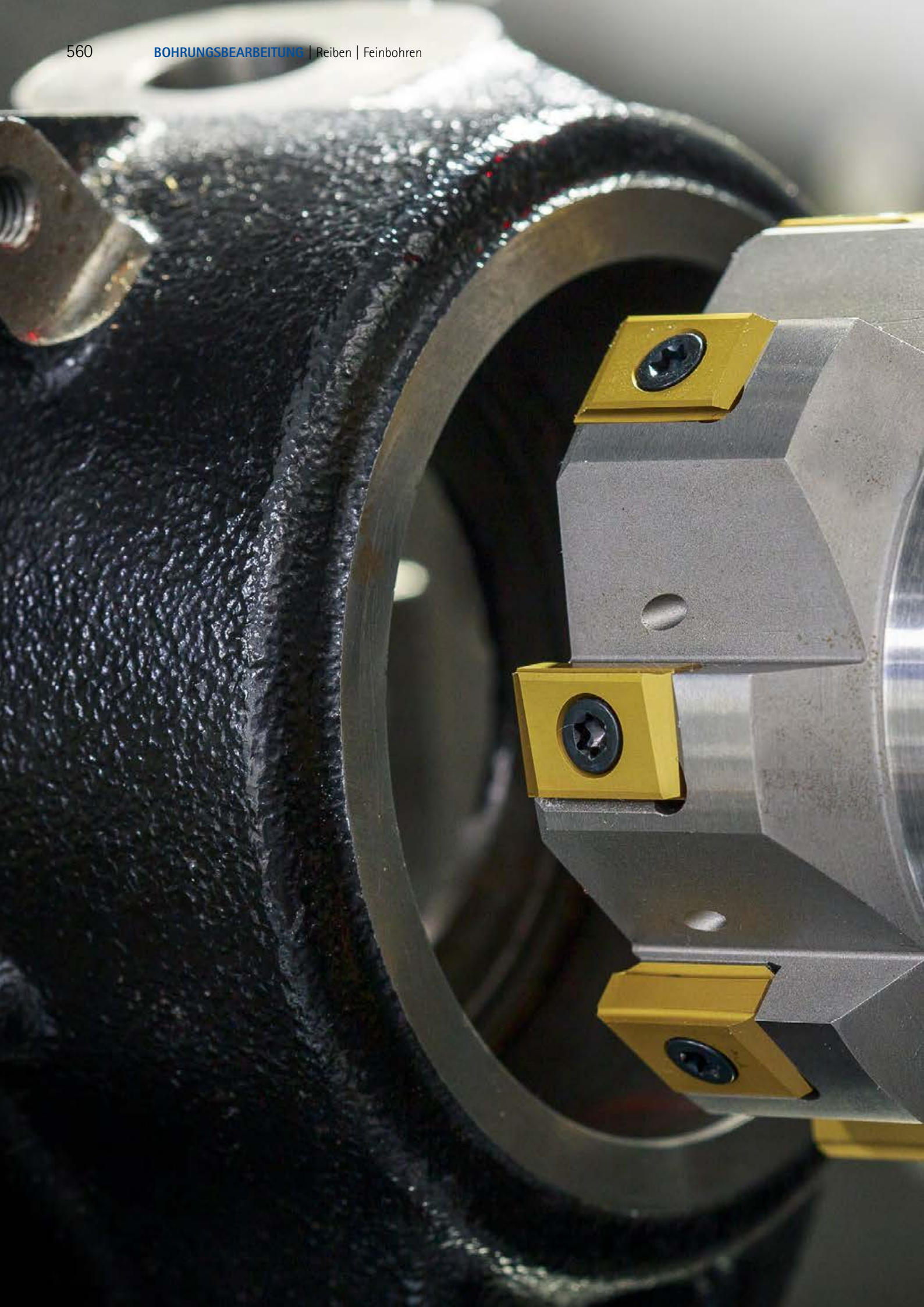



LÖSUNGEN FÜR GROSSE DURCHMESSER | SONDERLÖSUNGEN

Lösungen für große Durchmesser

Programmübersicht	562
HPR400 plus	564
HPR400	568

Sonderlösungen

Werkzeuge mit Führungsleisten	572
Werkzeuge mit EasyAdjust-System	574
Mehrschneidenreibahlen	576



PROGRAMMÜBERSICHT

Mehrschneidige Hochleistungsreibahlen für große Durchmesserbereiche

Um Bohrungen mit großen Durchmessern in einer definierten Toleranz feinzubearbeiten, stehen Anwender häufig vor der Frage: Reiben oder Ausspindeln? Auf der einen Seite kann mit mehrschneidigen Reibwerkzeugen erheblich schneller gearbeitet werden und sie sind weniger empfindlich bei unterbrochenem Schnitt. Auf der anderen Seite ist die Aufbereitung der Reibahlen mit fest eingebauten Schneiden ein aufwendiger Prozess.

Um diesen Wiederaufbereitungsprozess zu optimieren bietet MAPAL zwei HPR-Systeme an:

HPR400 plus

Im Mittelpunkt der Entwicklung der HPR400 plus Reibahlen stand die Steigerung der Wirtschaftlichkeit durch eine effiziente Wiederaufbereitung. Die mehrschneidigen Werkzeuge bestehen durch hohe Wirtschaftlichkeit dank schneller Einsatzdaten und einfachem Schneidenwechsel vor Ort durch den Kunden. Dies ist aufgrund der hochgenauen Plattensitze möglich. Damit entfallen die Logistikkosten für einen Transport zum Hersteller komplett. Umlaufbestand und Wiederaufbereitungskosten sind auf einem niedrigen Niveau. Wendeschneidplatten mit vier Schneidkanten garantieren optimale Schneidstoffausnutzung.

HPR400

Einfacher Schneidenwechsel vor Ort

Um die Umlaufmenge und den Lagerbestand zu reduzieren bietet MAPAL das System HPR400, bei dem der Schneidenwechsel direkt vor Ort durch den Kunden selbst durchgeführt werden kann. Die Grundkörper müssen nicht wiederaufbereitet werden, es fällt lediglich der Lageraufwand für die benötigten Schneiden an.



HPR

**HPR400 plus**

Vier Schneidkanten für hohe Wirtschaftlichkeit.

- Keine Logistikkosten für den Transport zur Wiederaufbereitung zum Hersteller
- IT7 Toleranz ab Durchmesser 65,000 mm realisierbar

Ø-Bereich: 63,000 - 319,999 mm

**HPR400**

Einfacher Schneidenwechsel vor Ort.

- Falsches Einbauen der Schneide ist ausgeschlossen, die Schneiden an einer beliebigen Position montiert werden können.

Ø-Bereich: 63,000 - 319,999 mm



HPR400 plus

Kein Einstellen und vier Schneidkanten reduzieren Cost-per-Part deutlich

Wirtschaftlichkeitssteigerungen durch effiziente Wiederaufbereitung standen im Mittelpunkt der Entwicklung der HPR400 Reibahlen. Die mehrschneidigen Werkzeuge bestehen durch hohe Wirtschaftlichkeit dank schneller Einsatzdaten und einfachem Schneidenwechsel vor Ort durch den Kunden. Dies ist aufgrund der hochgenauen Plattensitze möglich. Damit entfallen die Logistikkosten für einen Transport zum Hersteller komplett. Umlaufbestand und Wiederaufbereitungskosten sind auf einem niedrigen Niveau.

Um die Wirtschaftlichkeit bei der Bearbeitung großer Durchmesser weiter zu steigern, sind die Schneidplatten des neu entwickelten HPR400 plus nicht mehr einschneidig ausgeführt, sondern weisen vier Schneidkanten auf. Der Schneidstoff wird somit optimal genutzt. Die vierschneidigen Wendeschneidplatten sind so genau hergestellt, dass ein Wenden beziehungsweise Wechseln der Schneidplatten vor Ort durch Kundenmitarbeiter problemlos möglich ist.

Der Lagerbestand an Schneiden kann weiter reduziert werden, die Wiederaufbereitungskosten und damit die Cost-per-Part sinken.

AUF EINEN BLICK

- Schneidenwechsel vor Ort durch den Kunden
- Vier statt bisher einer Schneidkante
- Durchmesserbereich 63,000 bis 319,999 mm
- Universell in allen Werkstoffen einsetzbar
- Schneidstoff wird optimal genutzt
- Keine Logistikkosten für den Transport zur Wiederaufbereitung zum Hersteller
- Niedriger Umlaufbestand und niedrige Wiederaufbereitungskosten
- Einfaches Wenden und Wechseln der Schneidplatten

Werkzeugfeatures im Detail



1 Schneidplatte

Vierschneidig für hohe Wirtschaftlichkeit

2 Abstreiftasche

Zur Entfernung von Mikroverschmutzungen

3 TORX® PLUS-Schraube

4 Plattensitz

Hochgenau für optimale Toleranzeinhaltung

5 Schmutznut

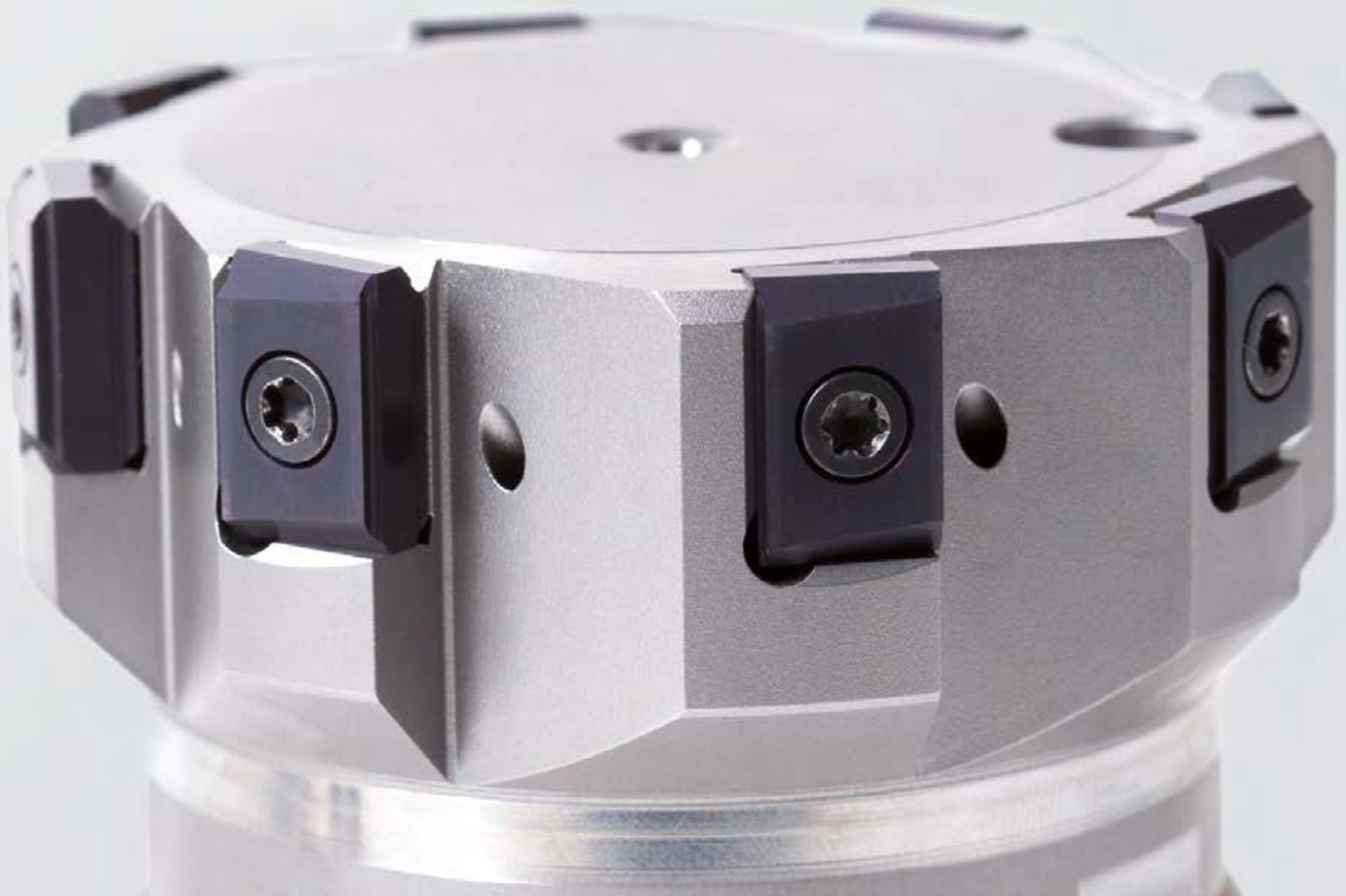

HPR400 plus



Schneidenwechsel vor Ort durch den Kunden

- Einfaches Handling
- Genauer Schneidenwechsel dank hochgenauem Plattensitz
- Kein Einstellen notwendig



Vier Schneidkanten für hohe Wirtschaftlichkeit

- Verschiedene Schneidstoffe und Anschnitte lieferbar
- Sonderschnitte sind auf Anfrage

IT10					
IT9					
IT8					
IT7					
IT6					
IT5					
IT4					
	65,001 - 80,000	80,001 - 120,000	120,001 - 180,000	180,001 - 250,000	250,001 - 315,000

IT7 Toleranz ab Durchmesser 65 mm

- Toleranzklasse IT7 problemlos bei größeren Durchmessern realisierbar, ebenso wie kleinere Toleranzen bei größeren Durchmessern

Hochleistungsreibahle HPR400 plus

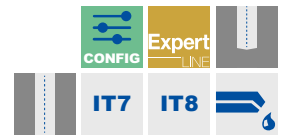
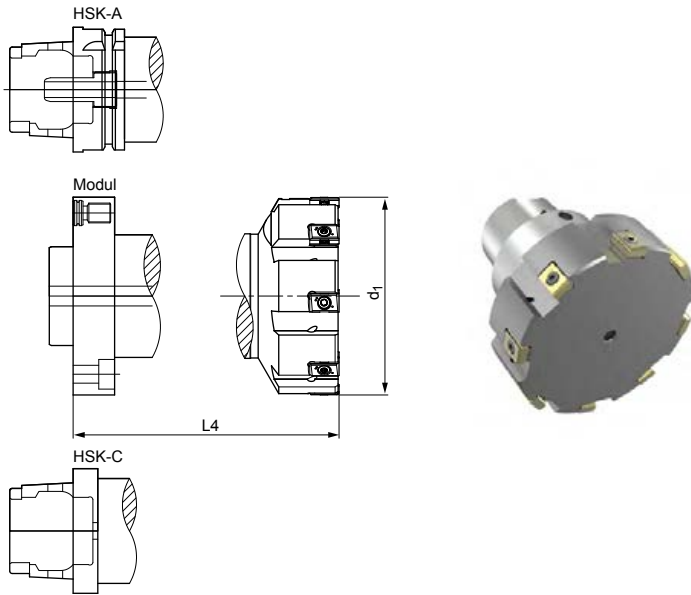

Abmessungen Grundkörper HPR400 plus

d ₁	z	Aufnahmegröße				
		HSK-C	HSK-A	Ausraglänge L4 frei wählbar	Modul	Ausraglänge L4 frei wählbar
63,000 - 79,999	8	HSK-C063	HSK-A063	65-290	60	65-320
80,000 - 99,999	8	HSK-C063	HSK-A063	65-290	80	65-320
100,000 - 124,999	8	HSK-C080	HSK-A080	75-330	100	75-320
125,000 - 159,999	8	HSK-C080	HSK-A080	75-330	100	75-320
160,000 - 199,999	8	HSK-C080	HSK-A080	75-330	140	90-320
200,000 - 249,999	10	HSK-C100	HSK-A100	90-300	140	90-320
250,000 - 319,999	12	HSK-C100	HSK-A100	90-300	140	90-320

Angaben sind nur Richtwerte, Abweichungen auf Anfrage

Konfigurierbare Merkmale



- Durchmesser in Abstufungen von 0,001 mm frei wählbar
- Ab Toleranz IT7 - IT8 (min 40 µm) bestellbar
- Alle gängigen Aufnahmen als Trennstelle möglich
- Als Stufenwerkzeug ausführbar
- mit anderen MAPAL Werkzeugsysteme und MAPAL Aufnahmesystemen kombinierbar
- MMS-fähig

Spezifikation:
Auf Anfrage



Zubehör und Ersatzteile	Materialnummer
Drehmomentschlüssel Set 1 - 5 Nm	30415174
Ersatzschraube M4x12	10018468

Wendeschnidplatten für HPR400 plus



Schneiden Vorzugsbaureihe

Durchmesserbereich	Materialnummer
63,000 - 79,999	30968871
80,000 - 99,999	30933385
100,000 - 124,999	30968884
125,000 - 159,999	30968891
160,000 - 199,999	30968898
200,000 - 249,999	30968905
250,000 - 319,999	30968912

Ausführung:

Durchmesserbereich: 63,000 - 319,999
 Vier Schneidkanten
 Anschnitt: 45° x 0,55 mm
 Schneidstoff: HC419



Schneiden Vorzugsbaureihe

Durchmesserbereich	Materialnummer
63,000 - 79,999	31315612
80,000 - 99,999	31315613
100,000 - 124,999	31149561
125,000 - 159,999	31315614
160,000 - 199,999	31315615
200,000 - 249,999	31315617
250,000 - 319,999	31315618

Ausführung:

Durchmesserbereich: 63,000 - 319,999
 Vier Schneidkanten
 Anschnitt: 30° x 0,60 mm
 + Schälwinkel
 Schneidstoff: CP004
 Werkstoffgruppe K
 Eignung für Oberfläche Ra < 2µm

HPR400

Reiben in großen Durchmessern mit einfachem Schneidenwechsel vor Ort

Durch spezielle, hochgenaue Plattensitze bei der HPR400 Baureihe können Anwender bei diesem System die Schneiden direkt vor Ort mit einem Drehmomentschlüssel selbst wechseln. Falsches Einbauen ist ausgeschlossen, da nur eine Einbaulage möglich ist und die Schneiden an einer beliebigen Position montiert werden können. Damit entfällt nicht nur der Einstellaufwand, sondern auch die Anlieferung zur Wiederaufbereitung. Anwender müssen lediglich die Schneiden von MAPAL vorrätig haben. Die Menge der benötigten Werkzeuge ist gering, da keine Grundkörper aufbereitet werden müssen. Mit minimalem Aufwand und geringer Umlaufmenge der Werkzeuge erreicht der Anwender mit dem HPR400 hochgenaue Bohrungen.

Die Schneiden werden optimal auf den Werkstoff und die Bearbeitung angepasst. Der

HPR400 ist im Durchmesserbereich von 63 bis 319,999 mm mit HSK- oder der MAPAL eigenen Modulaufnahme verfügbar. MAPAL bietet verschiedene Schneidplatten aus Hartmetall, ohne oder mit CVD-Beschichtung, aus Cermet und mit PKD oder PcBN bestückt.

AUF EINEN BLICK

- Selbstständiger Schneidenwechsel durch den Anwender vor Ort
- Schneidzuordnung unabhängig vom Plattensitz
- Senkung der Cost per Part
- Reduzierte Beschichtungskosten
- Senkung des Werkzeugumlaufbestandes
- Alle Schneidstoffe nutzbar
- Toleranz H7
- ø 63,000 – 319,999 mm



Werkzeugfeatures im Detail

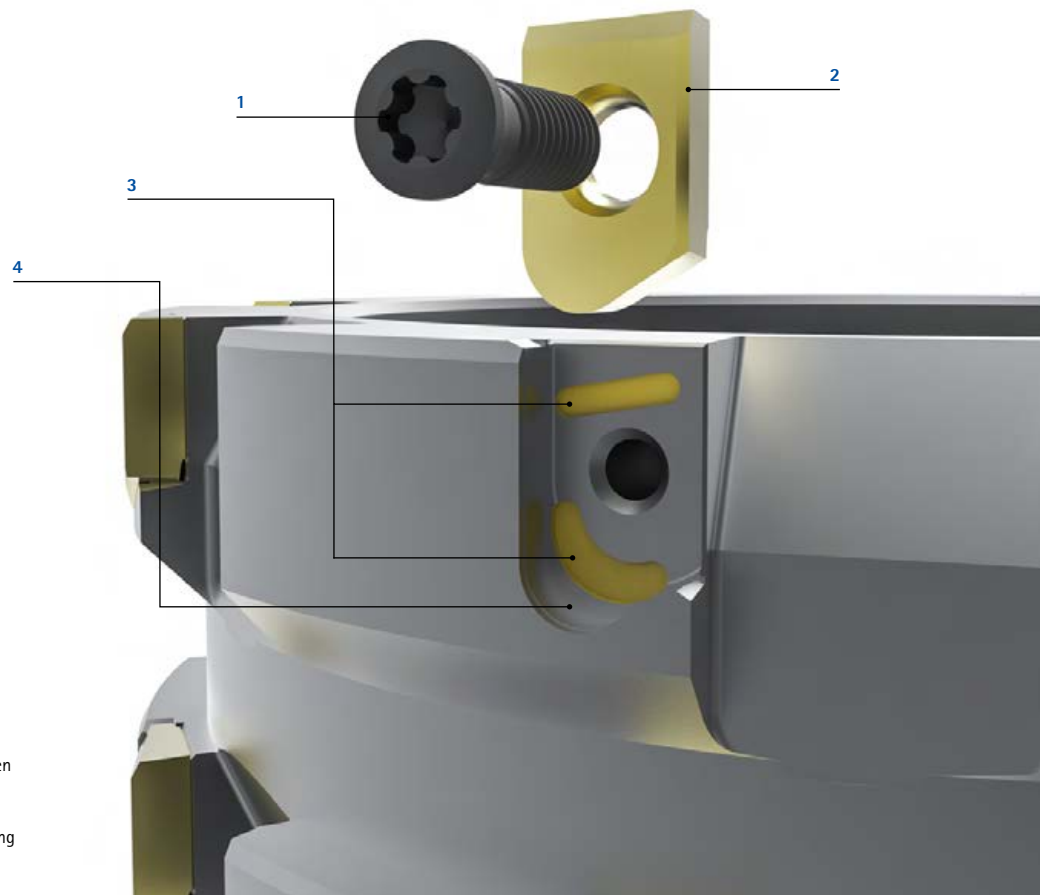

1 TORX® Spanschraube

2 Schneide

Prismatische Form für optimale Anlage

3 Abstreiftasche

Zur Entfernung von Mikroverschmutzungen

4 Plattensitz

Hochgenau für optimale Toleranzeinhaltung

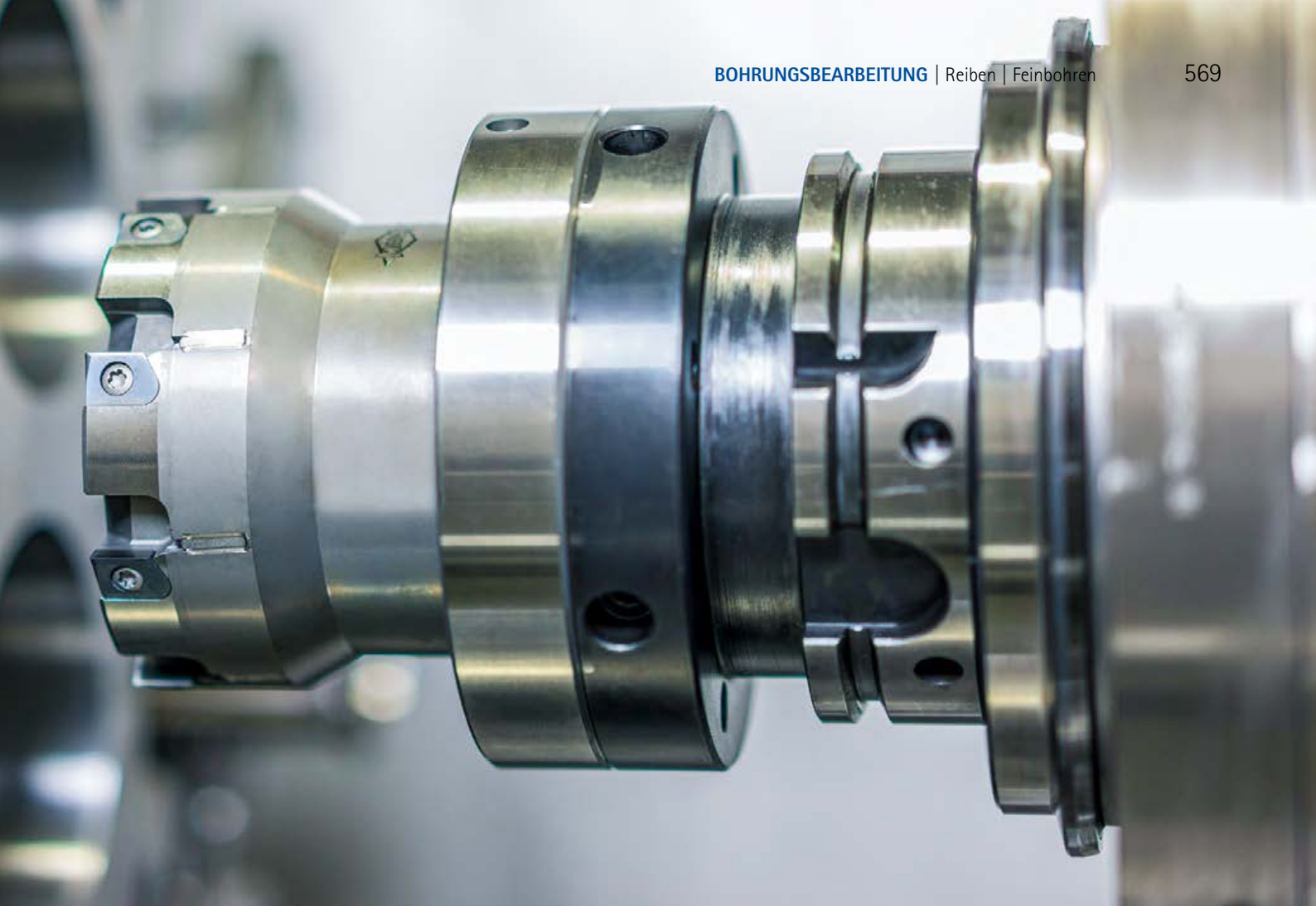

CVD-beschichtete Schneiden

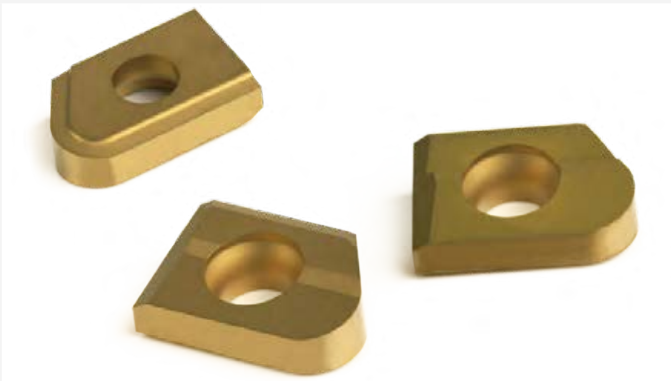

Optimal auf das Reiben von Gusswerkstoffen abgestimmt

Die für den HPR400 verfügbaren CVD-beschichteten Schneidstoffe, zu erkennen an dem Schneidstoffkürzel HC, wurden speziell für das Reiben von zähen Gusswerkstoffen GJL, GJS und GJV, bei schwierigen Bearbeitungsbedingungen, wie zum Beispiel unterbrochenem Schnitt, entwickelt. Die CVD-Beschichtung zeichnet sich durch eine hohe Zähigkeit bei guter Verschleißbeständigkeit aus. Bis zu dreifache Standzeiten gegenüber bestehenden PVD-beschichteten Schneiden bei hoher Prozesssicherheit sind mit den CVD-beschichteten Schneiden erreichbar. Durch das Klemmsystem sind zudem nahezu alle weiteren Schneidstoffe im HPR400-System realisierbar.

Kostengünstiges System



Einfacher Schneidenwechsel vor Ort

Mit dem HPR400 bietet MAPAL ein System, bei dem der Schneidenwechsel vor Ort durch den Kunden stattfindet. Die austauschbaren Schneiden werden axial in den Schneidplattensitz geschoben und durch eine Torxschraube im hochgenauen Plattensitzprozesssicher und hochgenau fixiert. Die Schneidzuordnung ist dabei unabhängig vom Plattensitz. Die Beschichtungskosten werden reduziert bei gleichzeitiger Senkung des Werkzeugumlaufbestandes.

Hochleistungsreibahle HPR400

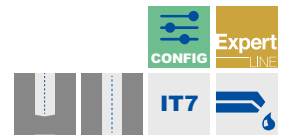
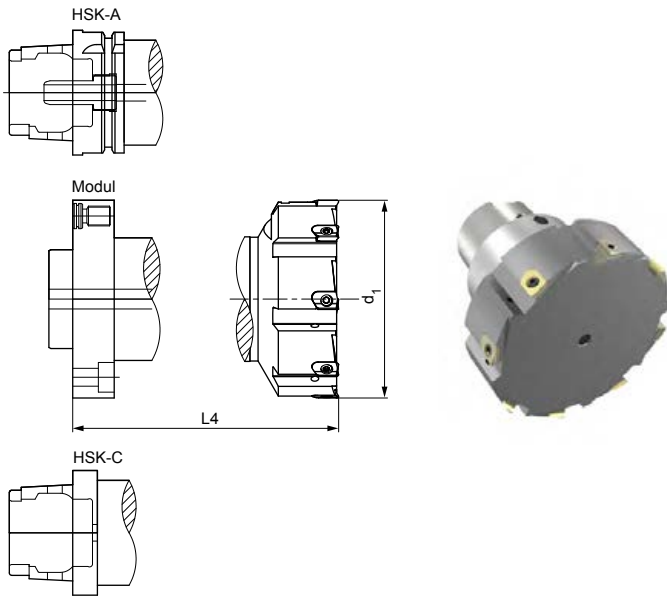

Abmessungen Grundkörper HPR400

d ₁	z	Aufnahmegröße				
		HSK-C	HSK-A	Ausraglänge L4 frei wählbar	Modul	Ausraglänge L4 frei wählbar
63,000 - 79,999	8	HSK-C063	HSK-A063	65-290	60	65-320
80,000 - 99,999	8	HSK-C063	HSK-A063	65-290	80	65-320
100,000 - 124,999	8	HSK-C080	HSK-A080	75-330	100	75-320
125,000 - 159,999	8	HSK-C080	HSK-A080	75-330	100	75-320
160,000 - 199,999	8	HSK-C080	HSK-A080	75-330	140	90-320
200,000 - 249,999	10	HSK-C100	HSK-A100	90-300	140	90-320
250,000 - 319,999	12	HSK-C100	HSK-A100	90-300	140	90-320

Angaben sind nur Richtwerte, Abweichungen auf Anfrage

Konfigurierbare Merkmale



- Durchmesser in Abstufungen von 0,001 mm frei wählbar
- Ab Toleranz IT7 bestellbar
- Stirnschnitt möglich
- Alle gängigen Aufnahmen als Trennstelle möglich
- Als Stufenwerkzeug ausführbar
- mit anderen MAPAL Werkzeugsysteme und MAPAL Aufnahmesystemen kombinierbar
- MMS-fähig

Spezifikation:
Auf Anfrage



Zubehör und Ersatzteile	Materialnummer
Drehmomentschlüssel Set 1 - 5 Nm	30415174
Ersatzschraube M3,5x9	10105078

Schneidplatten für HPR400



Schneiden Vorzugsbaureihe

Durchmesserbereich	Materialnummer
63,000 - 79,999	30916603
80,000 - 99,999	30794390
100,000 - 124,999	30809550
125,000 - 159,999	30788089
160,000 - 199,999	30809531
200,000 - 249,999	30938712
250,000 - 319,999	30931640

Ausführung:

Durchmesserbereich: 63,000 - 319,999
 Ein Schneidkante
 Anschnitt: 45° x 0,55 mm
 Schneidstoff: HC419



Schneiden Vorzugsbaureihe

Durchmesserbereich	Materialnummer
63,00 - 79,99	31026872
80,00 - 99,99	31129899
100,00 - 124,99	31049249
125,00 - 159,99	30690096
160,00 - 199,99	31149706
200,00 - 249,99	31149707
250,00 - 319,99	31129911

Ausführung:

Durchmesserbereich: 63,000 - 319,999
 Ein Schneidkante
 Anschnitt: 30° x 0,60 mm
 + Schälwinkel
 Schneidstoff: CP004
 Werkstoffgruppe K
 Eignung für Oberfläche Ra < 2µm

SONDERLÖSUNGEN

Werkzeuge mit Führungsleisten

Anwendungsspezifische Werkzeuglösungen

- 1 Leistungsführtes Aufbohrwerkzeug mit ISO-Kurzklemhalter in Leichtbauweise aus Aluminium zur Bearbeitung eines Getriebegehäuses
- 2 Feinbohrwerkzeug mit Wendeschneidplattensystem zur kombinierten Innen- und Außenbearbeitung eines Planetenträgers
- 3 Außenreibahle mit EasyAdjust-System und TEC-Schneiden zur Bearbeitung eines Abgaskrümmers mit MAPAL Pendelhalter
- 4 Feinbohrwerkzeug mit ISO-Vorschneidstufe und Schnittstelle für HPR-Reibkopf zur Bearbeitung eines Zylinderblocks
- 5 Feinbohrwerkzeug mit EasyAdjust-System mit HX-Schneiden zur Bearbeitung einer Kurbelwellenlagerbohrung
- 6 Feinbohrwerkzeug in Leichtbauweise als Schweißkonstruktion zur Bearbeitung eines Getriebegehäuses
- 7 Mehrstufiges und mehrschneidiges Feinbohrwerkzeug in Leichtbauweise aus Titan zur Bearbeitung eines Lenkgehäuses
- 8 Für Minimalmengenschmierung (MMS) ausgelegtes Feinbohrwerkzeug mit Wendeschneidplattensystem zur Bearbeitung eines Schaltschiebergehäuses
- 9 Mehrstufiges Feinbohrwerkzeug mit Wendeschneidplattensystem mit Konturschneiden und Planbearbeitung eines Pumpengehäuses
- 10 Feinbohrwerkzeug mit Wendeschneidplattensystem zur kombinierten Bearbeitung eines Planetenträgers
- 11 Tangentiales Feinbohrwerkzeug zur Semifinishbearbeitung mit modularem Schneidkopf zur Bearbeitung einer Kurbelwellenlagerbohrung
- 12 Außenreibahle mit Wendeschneidplattensystem als Leichtbauweise additiv gefertigt zur Bearbeitung eines Schaltschieberbolzens



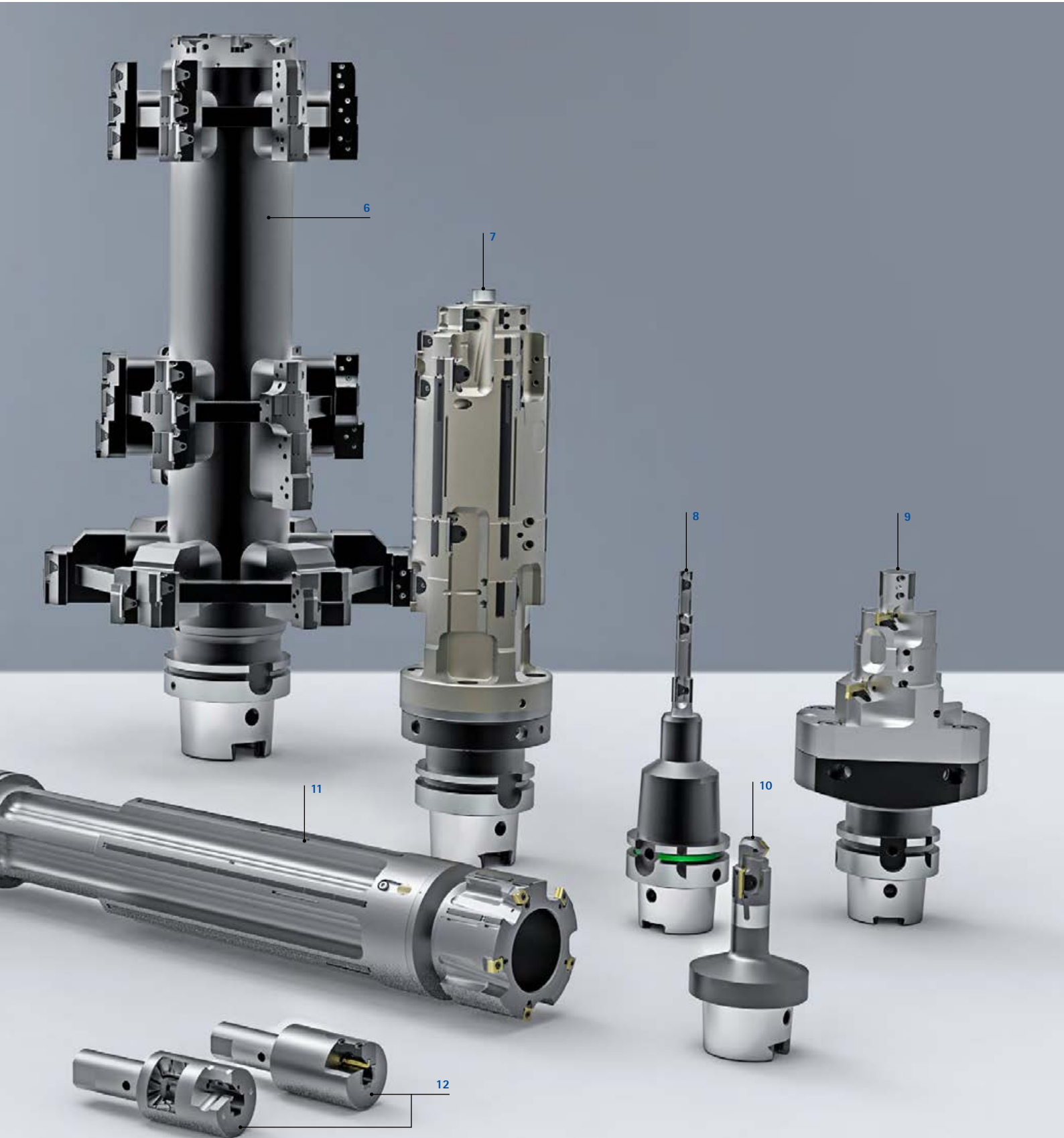

SONDERLÖSUNGEN

Werkzeuge mit EasyAdjust-System

Sonderlösungen mit EasyAdjust-System

- 1 Kombinationswerkzeuge zur Vor- und Fertigbearbeitung eines großen und kleinen Pleuelauges. Mit ISO-Schneiden zur Vorbearbeitung und EasyAdjust-System zur Fertigbearbeitung
- 2 Sonderwerkzeug mit EasyAdjust-System mit vier TEC-Schneiden ($z = 4$) und einseitig angeordneten Führungsleisten zur Bearbeitung eines stark unterbrochenen Schnittes in einem Pumpengehäuse aus GJS-400
- 3 Sechsschneidiges Werkzeug in der Schnittaufteilung 4+2 mit EasyAdjust-System mit HX-Schneiden zur Bearbeitung einer Zylinderbohrung
- 4 Mehrstufige Feinbohrwerkzeuge mit EasyAdjust-System mit TEC-Schneiden zur Bearbeitung einer Grundbohrungen in Getriebe- und Ventilgehäusen mit IT5- und IT6-Anforderungen an die Maßhaltigkeit
- 5 Werkzeuge zur Semi- und Finishbearbeitung einer Kurbelwellenlagerbohrung aus der Bi-Metall-kombination Aluminium-GJL
- 6 Außenreibahle mit EasyAdjust-System mit TEC-Schneiden ersetzt herkömmliches Drehen von einem Bauteil aus GJS mit besserer Maßhaltigkeit





SONDERLÖSUNGEN

Mehrschneidenreibahlen



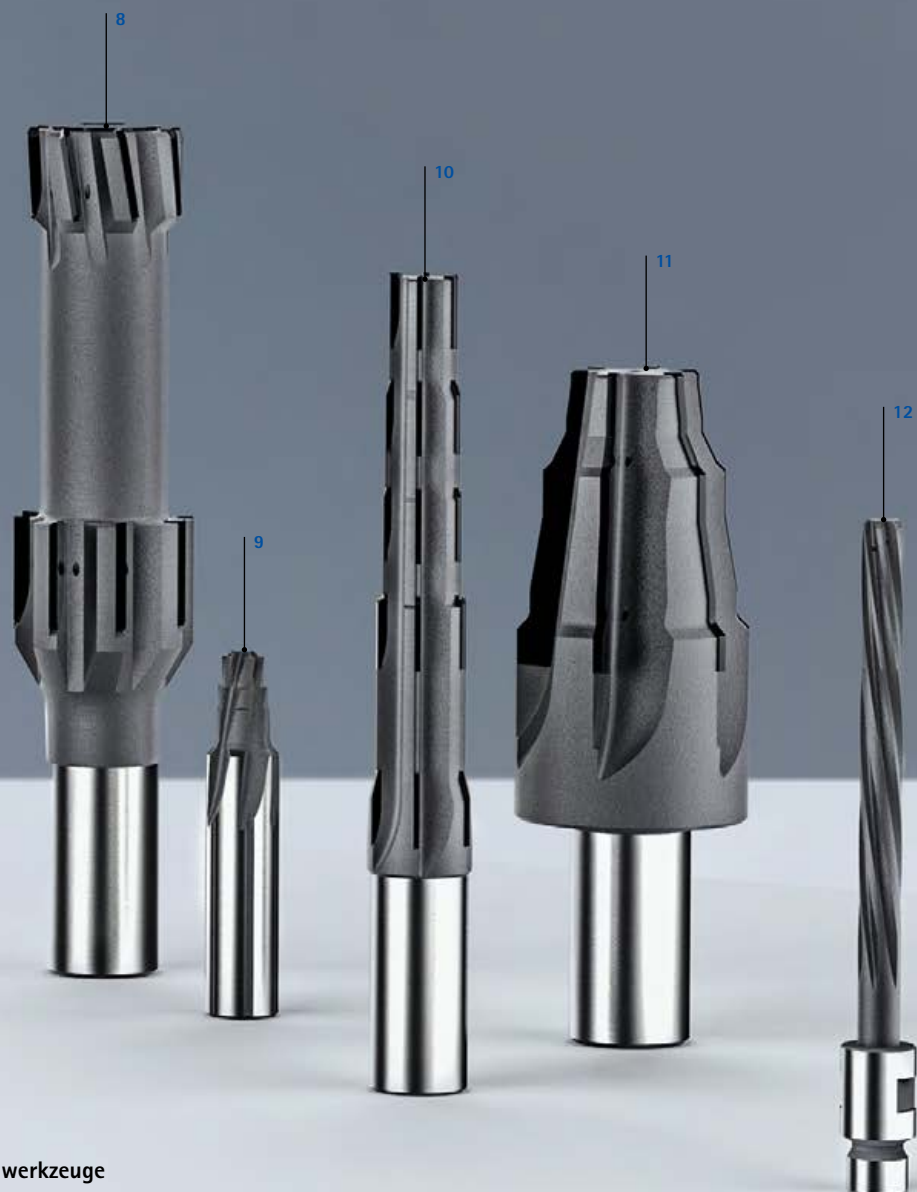

Sonderlösungen Vollhartmetallwerkzeuge

- 1 Zweistufiges Sonderwerkzeug mit gelöteten Schneiden zur Bearbeitung eines Hydraulikgehäuses aus EN-GJS-500-7
- 2 Mehrstufiges, beschichtetes Vollhartmetall-Sonderwerkzeug mit Fasen- und Radienbearbeitung zur Zerspänung eines Zylinderhalters aus Stahl
- 3 Beschichtete Vollhartmetall-Stufenreibahle zur Bearbeitung einer Injektorbohrung im Zylinderkopf
- 4 Beschichtete Vollhartmetall-Stufenreibahle zur Fertigbearbeitung einer Kontur der Zündkerzenbohrung in EN-GJL-250
- 5 Zweistufige Vollhartmetall-Stufenreibahle mit zusätzlicher Fasenbearbeitung zur Zerspänung einer Hochdruckpumpe aus Edelstahl
- 6 HSS-Maschinen-Kegelreibahle mit MK-Schaft
- 7 Vollhartmetall-Stufenreibahle mit VA-Geometrie zur Bearbeitung eines Ventilblocks aus Edelstahl
- 8 Zweistufige Sonderreibahle mit gelöteten Cermetschneiden mit kombinierter gerade und linksschräg genuteter Ausführung
- 9 Beschichtete mehrstufige Vollhartmetallreibahle mit Innenkühlung am Schaft zur Bearbeitung eines Rails
- 10 Stufenreibahle mit gelöteten halbrund eingebetteten Cermetschneiden zur Bearbeitung eines Düsenhalters aus Stahl
- 11 Beschichtete, hartmetallbestückte Formreibahle zur Bearbeitung von Sonderdrehteilen
- 12 Hochleistungsreibahle mit stumpf aufgelötetem Vollhartmetallkopf mit Sonderaufnahme für die Luftfahrt zur Bearbeitung einer Nietlochkombination aus Titan, Alu und hochlegiertem Stahl

SONDERLÖSUNGEN

HPR - High-Performance-Reamer





Sonderlösungen HPR

- 1 Sonderlösung mit modularem HPR-Mehrschneidenring und Vollhartmetall-Stufenreibahle mit additiv gefertigtem Halter mit Hydrodehnspanntechnologie zur Innen- und Außenspannung zur Ventilsitzbearbeitung
- 2 Mehrstufiges, modular aufgebautes Kombinationswerkzeug mit integrierter CFS-Schnittstelle für festes gelötetes CPR-Werkzeug mit ISO-Tangentialschneiden zur Vorbearbeitung und HPR300-System zur Fertigbearbeitung eines Bremssattels
- 3 Mehrstufiges PKD-bestücktes Sonderwerkzeug mit Senkstufe zur Bearbeitung eines Bauteils in der Luftfahrtindustrie
- 4 Mehrstufiges HPR-Sonderwerkzeug mit HFS-Schnittstelle zur Bearbeitung der Bohrung und Kontursenkung eines Turboladers aus GJL250
- 5 Mehrstufiges Sonderwerkzeug zur Gehäusebearbeitung mit tangential angeordneten Reibschneiden
- 6 Sonderwerkzeug zur Bearbeitung einer Nietlochbohrung in der Luftfahrtindustrie
- 7 Rechtschneidendes Werkzeug zur Grundbohrungsbearbeitung
- 8 Mehrstufiges Sonderwerkzeug mit speziellen Schneidengeometrien und HFS-Schnittstelle
- 9 Sonderwerkzeug in fester Ausführung mit gelöteten Schneiden für die Stufenbearbeitung von Plan- und Fasenübergängen der Aktuatorbohrung im Bremssattel

SONDERLÖSUNGEN

Mehrschneidenreibahlen für große Durchmesser

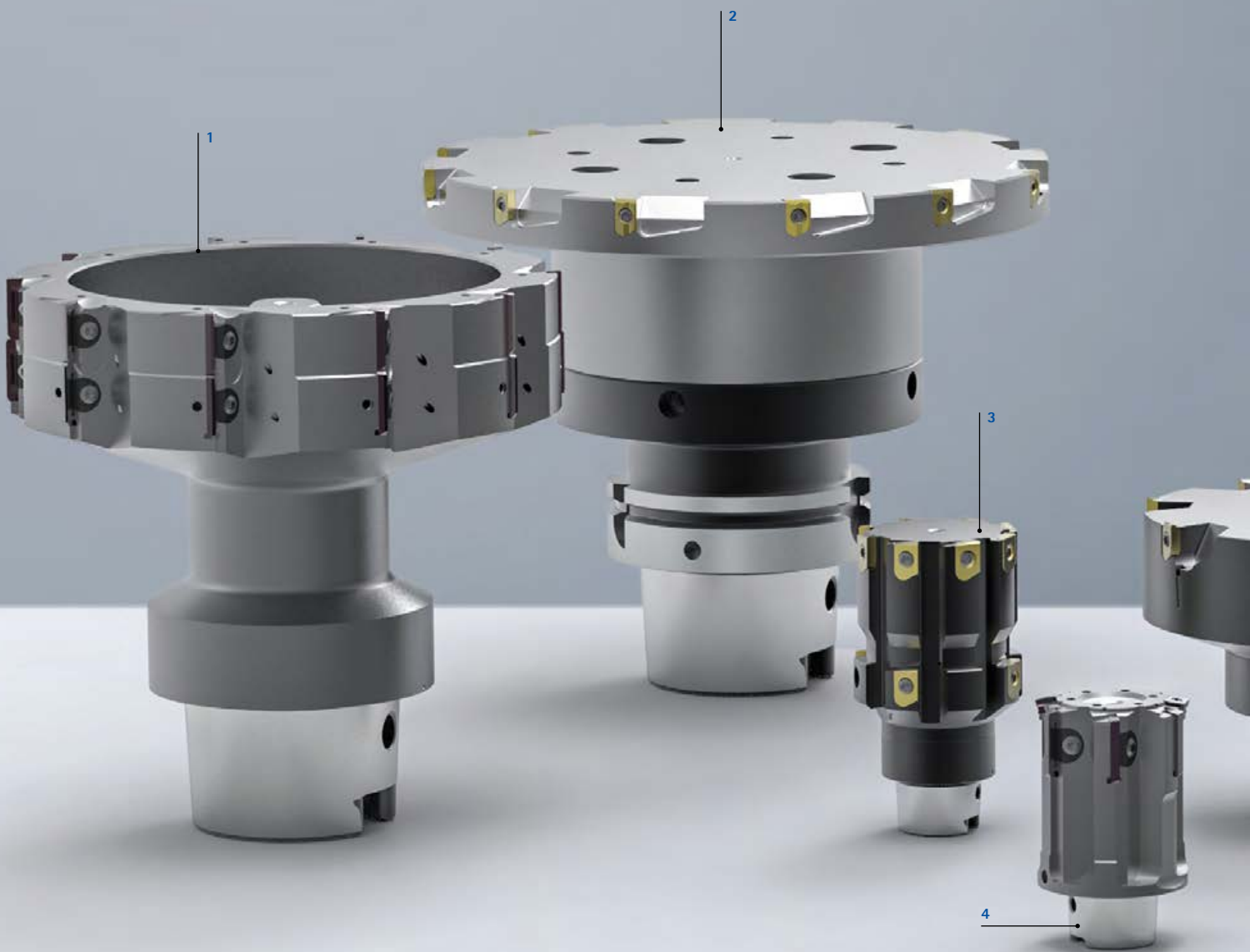



Sonderlösungen HPR300 und HPR400

- 1 Zweistufige HPR300-Sonderlösung zur Bearbeitung der Lagerbohrung eines Getriebegehäuses
- 2 HPR400 mit CVD-beschichteten Schneiden im Durchmesser 160 mm zur Bearbeitung eines Differenzialgehäuses mit ausrichtbarer Modulschnittstelle
- 3 Zweistufiges HPR400-Werkzeug mit acht Schneiden für die Kolbenbohrung und vier Schneiden für den Kontrollschnitt eines Bremsstellers
- 4 Kombinationswerkzeug mit ISO-Tangentialschneiden für die Vorbearbeitung und HPR300 mit PKD-bestückten Schneiden zur Fertigbearbeitung einer Messingbuchse
- 5 HPR400-Sonderwerkzeug für die Achsbrückenbohrung aus GJS-400 mit CVD-Sonderschneiden zur Lagersitzbearbeitung und zum Axialeinstich
- 6 Kombinationswerkzeug in Leichtbauweise mit ausrichtbarer Modulschnittstelle auf HSK-Adapter zur Bearbeitung eines Kegelradgehäuses. Mit ISO-Tangentialschneiden zur Vorbearbeitung und HPR400-System zur Fertigbearbeitung
- 7 HPR300 mit Fasenbearbeitung
- 8 Kombinationswerkzeug mit Vollhartmetallbohrer als Einstecklösung und HPR400-Reibstufe zur Bearbeitung eines Schwenklagers
- 9 HPR400-Stufenwerkzeug in Leichtbauweise mit ausrichtbarer Modulschnittstelle zur Bearbeitung eines Kegelradantriebsgehäuses



SENKEN

Senken mit extrem ungleich geteilten Kegelsenkern.
Ruhig, schnell und genau zur optimalen Senkung.



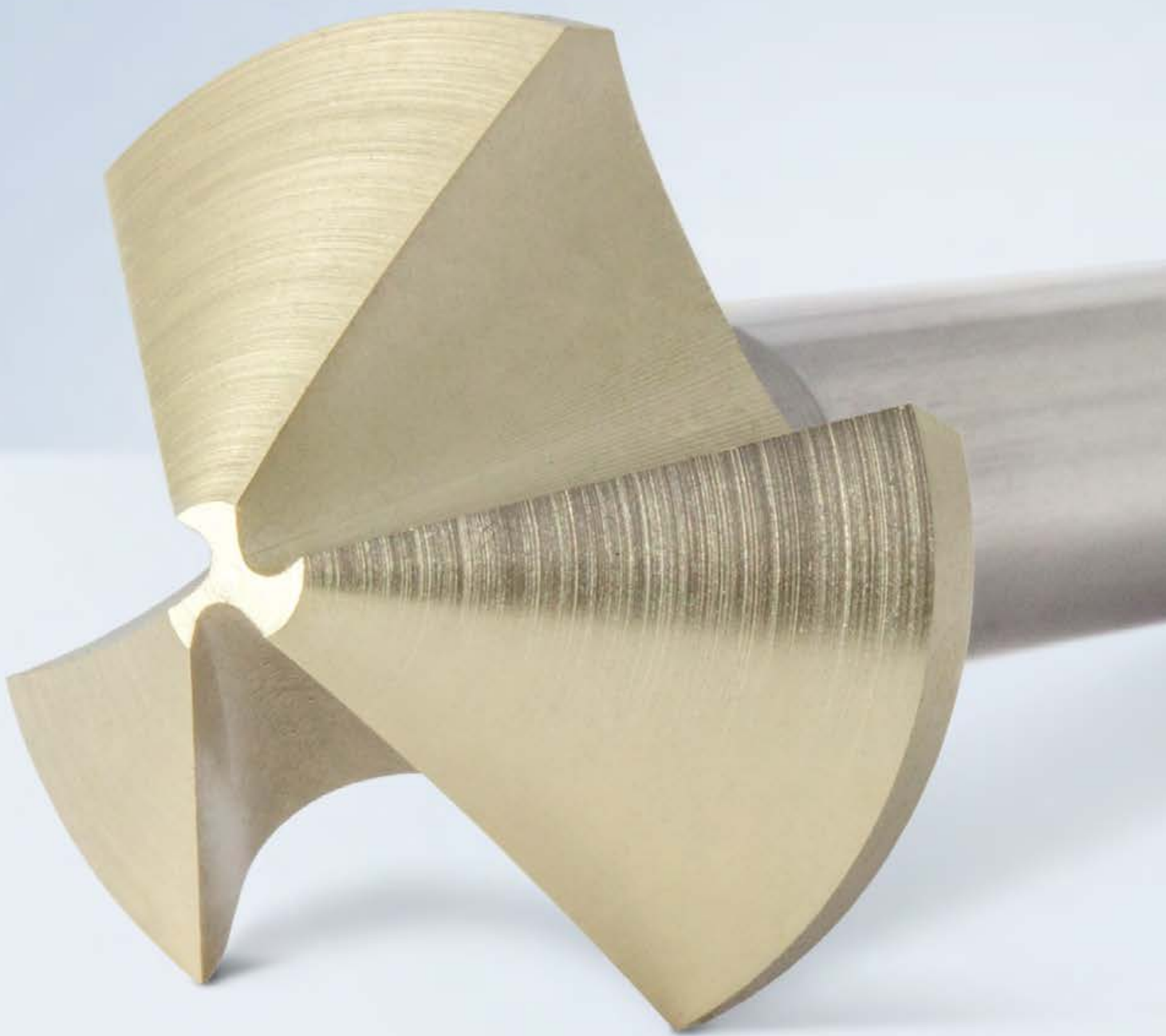

EXTREM UNGLEICH GETEILTE KEGELSENKER

Einführung

Technologie 586

Kegelsenker

HSS-Variante beschichtet 588

VHM-Variante beschichtet 589





EXTREM UNGLEICH GETEILTE KEGELSENKER

Endlich ruhig, schnell und genau

In jedem Bearbeitungsprozess verbergen sich Potenziale zur Produktivitätssteigerung. Auch in vermeintlich sekundären Bearbeitungen liegt erhebliches Verbesserungspotenzial. Dies beweisen die Kegelsenker von MAPAL.

Die Kegelsenker arbeiten mit deutlich reduzierten Axialkräften. Ihre Schneiden sind ungleich geteilt. Die Axialkraft ist bei dem gewählten Verhältnis im Vergleich zu herkömmlichen Kegelsenkern um mehr als 50 Prozent, die Radialkraft um 25 Prozent reduziert. Derart optimierte Einsatzbedingungen

erzeugen deutlich weniger Vibrationen am Werkzeug, wodurch höhere Genauigkeiten und bessere Oberflächenwerte erreicht werden. Die Präzision der Senkung führt zu einer unmittelbar besseren Anlage von Schrauben- und Nietlochverbindungen, wodurch ein Setzen der Verbindung im montierten Zustand unter Belastung ausbleibt. Die reduzierte Belastung der Maschine erhöht zudem die Standzeit der Werkzeuge. Auch können die Werkzeuge durch ihren ruhigen, stabilen Lauf mit höheren Schnittwerten gefahren werden. Dies führt zu erheblichen Zeiteinsparungen.



Werkzeugfeatures im Detail

Reduzierte Radialkraft um 25 %

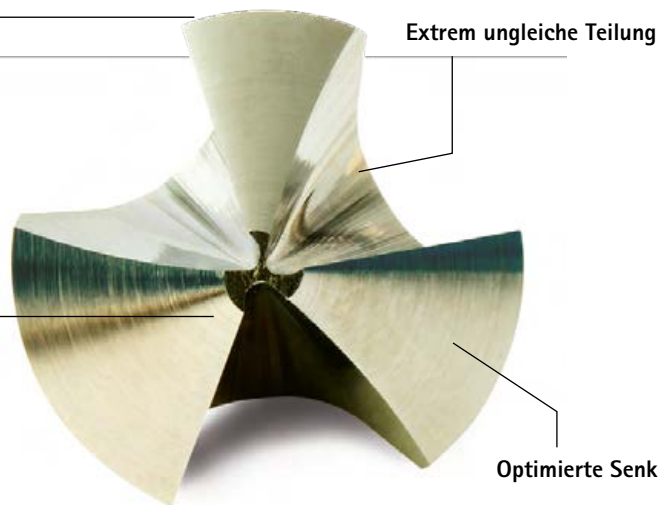
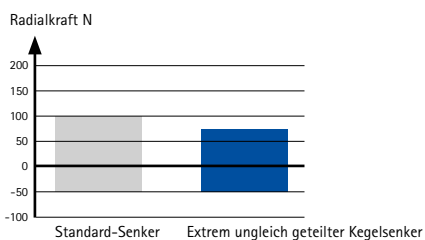

Reduzierte Axialkraft um 50 %

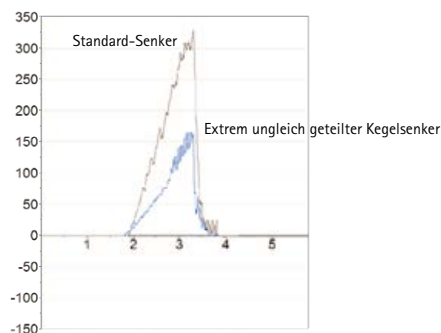

Extrem ungleich geteilter Kegelsenker



Standard-Senker

HSS-Ausführung beschichtet



Für alle gängigen Werkstoffe, wie Stahl, Inox oder Aluminium, sind die Kegelsenker in HSS-Ausführung mit Hochleistungsbeschichtung das Mittel der Wahl. Die Beschichtung sorgt für lange Standzeiten. Die Werkzeuge arbeiten zuverlässig und prozesssicher auch bei hohen Schnittgeschwindigkeiten. Für anspruchsvollere Werkstoffe empfiehlt sich der Einsatz der Ausführung aus Vollhartmetall.

VHM-Ausführung beschichtet



Zusätzlich zu den hochleistungsbeschichteten HSS-Ausführungen der Kegelsenker bietet MAPAL ausgewählte Durchmesser auch als beschichtete Vollhartmetallversion. Die VHM-Ausführung birgt neben den Vorteilen der Ungleichteilung einen zusätzlichen Mehrwert vor allem bei der Bearbeitung anspruchsvoller Werkstoffe wie Titan, hochlegiertem Guss, Inconel oder CFK. Höhere Standzeiten und Schnittgeschwindigkeiten gegenüber der beschichteten HSS-Ausführung werden prozesssicher erreicht.

Bohrer-Sonderausführungen mit Senkstufe



MAPAL bietet für nahezu alle Vollhartmetallbohrer die Möglichkeit diese als Sonderlösung mit einer Senkstufe zu fertigen. Damit können die beiden Bearbeitungen Bohren und Senken mit nur einem Werkzeug realisiert und Nebenzeiten reduziert werden. Modernste Fertigungstechnologien sowie die flexible Fertigung bei MAPAL ermöglichen kurze Lieferzeiten für Sonderlösungen weltweit.

Kegelsenker 90°

HSS-Ausführung beschichtet, extrem ungleich geteilt
COS110

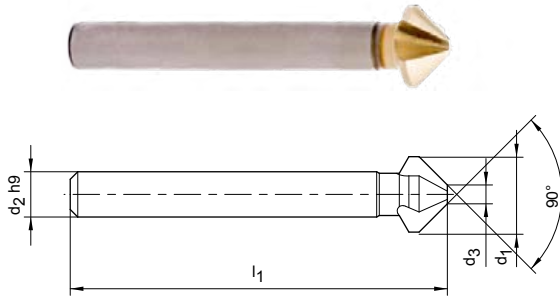

Baumaße					Spezifikation	Bestell-Nr.
d ₁	d ₂	d ₃	l ₁	z		
4,30	4	1,3	40	3	COS110-0430-335C-SP345	30662991
6,00	5	1,5	45	3	COS110-0600-335C-SP345	30662992
6,30	5	1,5	45	3	COS110-0630-335C-SP345	30633783
8,00	6	2,0	50	3	COS110-0800-335C-SP345	30662993
8,30	6	2,0	50	3	COS110-0830-335C-SP345	30662994
10,00	6	2,5	50	3	COS110-1000-335C-SP345	30662996
10,40	6	2,5	50	3	COS110-1040-335C-SP345	30633784
11,50	8	2,8	56	3	COS110-1150-335C-SP345	30662997
12,40	8	2,8	56	3	COS110-1240-335C-SP345	30662998
15,00	10	3,2	60	3	COS110-1500-335C-SP345	30662999
16,50	10	3,2	60	3	COS110-1650-335C-SP345	30633786
19,00	10	3,5	63	3	COS110-1900-335C-SP345	30663000
20,50	10	3,5	63	3	COS110-2050-335C-SP345	30633787
23,00	10	3,8	67	3	COS110-2300-335C-SP345	30663001
25,00	10	3,8	67	3	COS110-2500-335C-SP345	30633788
31,00	12	4,2	71	3	COS110-3100-335C-SP345	30663003



Kegelsenker-Set

d ₁	Spezifikation	Bestell-Nr.
6,30 - 25,00	COS110-6.3-25-335C-SP345-SET Set bestehend aus ø 6,30 mm ø 10,4 mm ø 16,5 mm ø 20,5 mm ø 25,0 mm	30634356

Kegelsenker 90°

Vollhartmetallausführung beschichtet, extrem ungleich geteilt
COS110

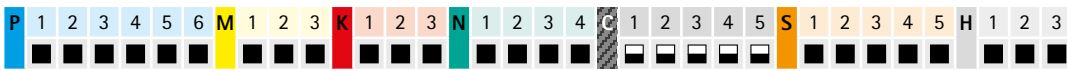
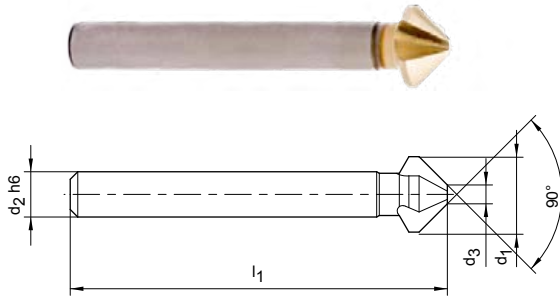

Baumaße					Spezifikation	Bestell-Nr.
d ₁	d ₂	d ₃	l ₁	z		
6,30	5	1,5	45	3	COS110-0630-335C-HP437	30799189
8,30	6	2,0	50	3	COS110-0830-335C-HP437	30799191
10,40	6	2,5	50	3	COS110-1040-335C-HP437	30799192
12,40	8	2,8	56	3	COS110-1240-335C-HP437	30799195
16,50	10	3,2	60	3	COS110-1650-335C-HP437	30799198
20,50	10	3,5	63	3	COS110-2050-335C-HP437	30799199
25,00	10	3,8	67	3	COS110-2500-335C-HP437	30799201
31,00	12	4,2	71	3	COS110-3100-335C-HP437	30799203

Schnittwertempfehlung für Kegelsenker

Kegelsenker extrem ungleich geteilt – HSS-Ausführung beschichtet
Vorschub und Schnittgeschwindigkeit

MZG*	Werkstoff	Festigkeit/Härte [N/mm ²] [HRC]
P	P1.1 Bau-, Automaten-, Einsatz- und Vergütungsstähle, unlegiert	< 700
	P1.2 Bau-, Automaten-, Einsatz- und Vergütungsstähle, unlegiert	< 1.200
	P2.1 Nitrier-, Einsatz- und Vergütungsstähle, legiert	< 900
	P2.2 Nitrier-, Einsatz- und Vergütungsstähle, legiert	< 1.400
	P3.1 Werkzeug-, Wälzlager-, Feder- und Schnellarbeitsstähle**	< 800
	P3.2 Werkzeug-, Wälzlager-, Feder- und Schnellarbeitsstähle**	< 1.000
	P3.3 Werkzeug-, Wälzlager-, Feder- und Schnellarbeitsstähle**	< 1.500
	P4.1 Rostfreie Stähle, ferritisch und martensitisch	
	P5.1 Stahlguss	
	P6.1 Rostfreier Stahlguss, ferritisch und martensitisch	
M	M1.1 Rostfreie Stähle, austenitisch	< 700
	M1.2 Rostfreie Stähle, ferritisch/austenitisch (Duplex)	< 1.000
	M2.1 Rostfreier Stahlguss, austenitisch	< 700
	M3.1 Rostfreier Stahlguss, ferritisch/austenitisch (Duplex)	< 1.000
K	K1.1 Gusseisen mit Lamellengraphit (Grauguss), GJL	< 300
	K2.1 Gusseisen mit Kugelgraphit, GJS	< 500
	K2.2 Gusseisen mit Kugelgraphit, GJS	≤ 800
	K2.3 Gusseisen mit Kugelgraphit, GJS	> 800
	K3.1 Gusseisen mit Vermiculargraphit, GJV; Temperguss, GJM	< 500
	K3.2 Gusseisen mit Vermiculargraphit, GJV; Temperguss, GJM	> 500
N	N1.1 Aluminium, unlegiert und legiert < 3 % Si	
	N1.2 Aluminium, legiert ≤ 7 % Si	
	N1.3 Aluminium, legiert > 7-12 % Si	
	N1.4 Aluminium, legiert > 12 % Si	
	N2.1 Kupfer, unlegiert und niedriglegiert	< 300
	N2.2 Kupfer, legiert	> 300
	N2.3 Messing, Bronze, Rotguss	< 1.200
	N4.1 Kunststoff, Thermoplaste	
	N4.2 Kunststoff, Duroplaste	
	N4.3 Kunststoff, Schaumstoffe	
S	S1.1 Titan, Titanlegierungen	< 400
	S2.1 Titan, Titanlegierungen	< 1.200
	S2.2 Titan, Titanlegierungen	> 1.200
	S3.1 Nickel, unlegiert und legiert	< 900
	S3.2 Nickel, unlegiert und legiert	> 900
	S4.1 Hochwarmfeste Superlegierung, Ni-, Co-, und Fe-basiert	
	S5.1 Wolfram- und Molybdänlegierungen	
H	H1.1 Gehärteter Stahl/Stahlguss	< 44
	H1.2 Gehärteter Stahl/Stahlguss	< 55

* MAPAL Zerspanungsgruppen

** Wenn die Legierungsbestandteile Cr, Mo, Ni, V, W in Summe > 8 % dann die nächst höhere MAPAL Zerspanungsgruppe wählen.

Nächste Seite:
Vollhartmetallausführung

	ø < 5 [mm]		ø < 5 - 8 [mm]		ø < 8 - 12 [mm]		ø < 12 - 16 [mm]		ø < 16 - 20 [mm]		ø < 20 - 25 [mm]		ø < 25 - 31 [mm]	
	v _c [m/min]	f [mm]	v _c [m/min]	f [mm]	v _c [m/min]	f [mm]	v _c [m/min]	f [mm]	v _c [m/min]	f [mm]	v _c [m/min]	f [mm]	v _c [m/min]	f [mm]
	40	0,06	40	0,08	40	0,10	40	0,12	40	0,14	40	0,18	40	0,22
	30	0,04	30	0,06	30	0,08	30	0,10	30	0,12	30	0,14	30	0,18
	30	0,04	30	0,06	30	0,08	30	0,10	30	0,12	30	0,14	30	0,18
	12	0,03	12	0,04	12	0,05	12	0,06	12	0,08	12	0,10	12	0,12
	30	0,04	30	0,06	30	0,08	30	0,10	30	0,12	30	0,14	30	0,18
	12	0,03	12	0,04	12	0,05	12	0,06	12	0,08	12	0,10	12	0,12
	15	0,04	15	0,05	15	0,06	15	0,07	15	0,08	15	0,09	15	0,12
	30	0,04	30	0,06	30	0,08	30	0,10	30	0,12	30	0,14	30	0,18
	15	0,04	15	0,05	15	0,06	15	0,07	15	0,08	15	0,09	15	0,12
	15	0,04	15	0,05	15	0,06	15	0,07	15	0,08	15	0,09	15	0,12
	10	0,04	10	0,05	10	0,06	10	0,07	10	0,08	10	0,09	10	0,12
	15	0,04	15	0,05	15	0,06	15	0,07	15	0,08	15	0,09	15	0,12
	20	0,06	20	0,10	20	0,12	20	0,14	20	0,18	20	0,20	20	0,25
	20	0,06	20	0,10	20	0,12	20	0,14	20	0,18	20	0,20	20	0,25
	20	0,06	20	0,10	20	0,12	20	0,14	20	0,18	20	0,20	20	0,25
	20	0,06	20	0,10	20	0,12	20	0,14	20	0,18	20	0,20	20	0,25
	20	0,06	20	0,10	20	0,12	20	0,14	20	0,18	20	0,20	20	0,25
	20	0,06	20	0,10	20	0,12	20	0,14	20	0,18	20	0,20	20	0,25
	50	0,08	50	0,10	50	0,12	50	0,14	50	0,18	50	0,22	50	0,26
	50	0,08	50	0,10	50	0,12	50	0,14	50	0,18	50	0,22	50	0,26
	40	0,08	40	0,10	40	0,12	40	0,14	40	0,18	40	0,22	40	0,26
	40	0,08	40	0,10	40	0,12	40	0,14	40	0,18	40	0,22	40	0,26
	40	0,10	40	0,12	40	0,14	40	0,18	40	0,20	40	0,24	40	0,30
	40	0,10	40	0,12	40	0,14	40	0,18	40	0,20	40	0,24	40	0,30
	40	0,10	40	0,12	40	0,14	40	0,18	40	0,20	40	0,24	40	0,30
	40	0,10	40	0,12	40	0,14	40	0,18	40	0,20	40	0,24	40	0,30
	40	0,10	40	0,12	40	0,14	40	0,18	40	0,20	40	0,24	40	0,30
	10	0,04	10	0,05	10	0,06	10	0,07	10	0,08	10	0,09	10	0,12
	10	0,04	10	0,05	10	0,06	10	0,07	10	0,08	10	0,09	10	0,12
	10	0,04	10	0,05	10	0,06	10	0,07	10	0,08	10	0,09	10	0,12
	10	0,04	10	0,05	10	0,06	10	0,07	10	0,08	10	0,09	10	0,12
	10	0,04	10	0,05	10	0,06	10	0,07	10	0,08	10	0,09	10	0,12
	10	0,04	10	0,05	10	0,06	10	0,07	10	0,08	10	0,09	10	0,12
	10	0,04	10	0,05	10	0,06	10	0,07	10	0,08	10	0,09	10	0,12
	6	0,04	6	0,05	6	0,06	6	0,08	6	0,08	6	0,10		
	6	0,04	6	0,05	6	0,06	6	0,08	6	0,08	6	0,10		

Die angegebenen Schnittwerte sind Richtwerte.

Die für den jeweiligen Bearbeitungsfall optimalen Daten sollten im Versuch oder während der Bearbeitung ermittelt werden.

Schnittwertempfehlung für Kegelsenker

Kegelsenker extrem ungleich geteilt – Vollhartmetallausführung beschichtet
Vorschub und Schnittgeschwindigkeit

MZG*	Werkstoff	Festigkeit/Härte [N/mm ²] [HRC]
P	P1.1 Bau-, Automaten-, Einsatz- und Vergütungsstähle, unlegiert	< 700
	P1.2 Bau-, Automaten-, Einsatz- und Vergütungsstähle, unlegiert	< 1.200
	P2.1 Nitrier-, Einsatz- und Vergütungsstähle, legiert	< 900
	P2.2 Nitrier-, Einsatz- und Vergütungsstähle, legiert	< 1.400
	P3.1 Werkzeug-, Wälzlager-, Feder- und Schnellarbeitsstähle**	< 800
	P3.2 Werkzeug-, Wälzlager-, Feder- und Schnellarbeitsstähle**	< 1.000
P3.3 Werkzeug-, Wälzlager-, Feder- und Schnellarbeitsstähle**	< 1.500	
P4.1 Rostfreie Stähle, ferritisch und martensitisch		
P5.1 Stahlguss		
P6.1 Rostfreier Stahlguss, ferritisch und martensitisch		
M	M1.1 Rostfreie Stähle, austenitisch	< 700
	M1.2 Rostfreie Stähle, ferritisch/austenitisch (Duplex)	< 1000
	M2.1 Rostfreier Stahlguss, austenitisch	< 700
M3.1 Rostfreier Stahlguss, ferritisch/austenitisch (Duplex)	< 1.000	
K	K1.1 Gusseisen mit Lamellengraphit (Grauguss), GJL	< 300
	K2.1 Gusseisen mit Kugelgraphit, GJS	< 500
	K2.2 Gusseisen mit Kugelgraphit, GJS	≤ 800
	K2.3 Gusseisen mit Kugelgraphit, GJS	> 800
	K3.1 Gusseisen mit Vermiculargraphit, GJV; Temperguss, GJM	< 500
K3.2 Gusseisen mit Vermiculargraphit, GJV; Temperguss, GJM	> 500	
N	N1.1 Aluminium, unlegiert und legiert < 3 % Si	
	N1.2 Aluminium, legiert ≤ 7 % Si	
	N1.3 Aluminium, legiert > 7-12 % Si	
	N1.4 Aluminium, legiert > 12 % Si	
	N2.1 Kupfer, unlegiert und niedriglegiert	< 300
	N2.2 Kupfer, legiert	> 300
	N2.3 Messing, Bronze, Rotguss	< 1.200
	N3.1 Graphit >8 µm	
	N3.2 Graphit <8 µm	
	N4.1 Kunststoff, Thermoplaste	
N4.2 Kunststoff, Duroplaste		
N4.3 Kunststoff, Schaumstoffe		
C	C1.1 Kunststoffmatrix, Aramidfaserverstärkt (AFK)	
	C1.2 Kunststoffmatrix (duroplastisch), CFK/GFK	
	C1.3 Kunststoffmatrix (thermoplastisch), CFK/GFK	
	C2.1 Kohlenstoffmatrix, Kohlenstofffaserverstärkt (CFC)	
	C3.1 Metallmatrix (MMC)	
	C4.1 Sandwichkonstruktion, Wabenkern (Honeycomb)	
	C4.2 Sandwichkonstruktion, Schaumkern	
	C5.1 Schichtverbund (Stack), Nichtmetall-Nichteisenmetall-Verbund	
	C5.2 Schichtverbund (Stack), Nichtmetall-Metall-Verbund	
	C5.3 Schichtverbund (Stack), Nichtmetall-Nichtmetall-Verbund	
	C5.4 Schichtverbund (Stack), Nichteisenmetall-Nichteisenmetall-Verbund	
	C5.5 Schichtverbund (Stack), Nichteisenmetall-Metall-Verbund	
C5.6 Schichtverbund (Stack), Metall-Metall-Verbund		
S	S1.1 Titan, Titanlegierungen	< 400
	S2.1 Titan, Titanlegierungen	< 1.200
	S2.2 Titan, Titanlegierungen	> 1.200
	S3.1 Nickel, unlegiert und legiert	< 900
	S3.2 Nickel, unlegiert und legiert	> 900
	S4.1 Hochwarmfeste Superlegierung, Ni-, Co-, und Fe-basiert	
S5.1 Wolfram- und Molybdänlegierungen		
H	H1.1 Gehärteter Stahl/Stahlguss	< 44
	H1.2 Gehärteter Stahl/Stahlguss	< 55
	H2.1 Gehärteter Stahl/Stahlguss	< 60
	H2.2 Gehärteter Stahl/Stahlguss	< 65
	H2.3 Gehärteter Stahl/Stahlguss	< 68
H3.1 Verschleißbeständiger Guss/Hartguss, GJN		

* MAPAL Zerspanungsgruppen

** Wenn die Legierungsbestandteile Cr, Mo, Ni, V, W in Summe > 8 % dann die nächst höhere MAPAL Zerspanungsgruppe wählen.

	ø < 5 [mm]		ø < 5 - 8 [mm]		ø < 8 - 12 [mm]		ø < 12 - 16 [mm]		ø < 16 - 20 [mm]		ø < 20 - 25 [mm]		ø < 25 - 31 [mm]	
	v _c [m/min]	f [mm]	v _c [m/min]	f [mm]	v _c [m/min]	f [mm]	v _c [m/min]	f [mm]	v _c [m/min]	f [mm]	v _c [m/min]	f [mm]	v _c [m/min]	f [mm]
	60	0,06	60	0,08	60	0,10	60	0,12	60	0,14	60	0,18	60	0,22
	50	0,04	50	0,06	50	0,08	50	0,10	50	0,12	50	0,14	50	0,18
	50	0,04	50	0,06	50	0,08	50	0,10	50	0,12	50	0,14	50	0,18
	40	0,03	40	0,04	40	0,05	40	0,06	40	0,08	40	0,10	40	0,12
	50	0,04	50	0,06	50	0,08	50	0,10	50	0,12	50	0,14	50	0,18
	40	0,03	40	0,04	40	0,05	40	0,06	40	0,08	40	0,10	40	0,12
	30	0,04	30	0,05	30	0,06	30	0,07	30	0,08	30	0,09	30	0,12
	50	0,04	50	0,06	50	0,08	50	0,10	50	0,12	50	0,14	50	0,18
	30	0,04	30	0,05	30	0,06	30	0,07	30	0,08	30	0,09	30	0,12
	30	0,04	30	0,05	30	0,06	30	0,07	30	0,08	30	0,09	30	0,12
	25	0,04	25	0,05	25	0,06	25	0,07	25	0,08	25	0,09	25	0,12
	30	0,04	30	0,05	30	0,06	30	0,07	30	0,08	30	0,09	30	0,12
	25	0,04	25	0,05	25	0,06	25	0,07	25	0,08	25	0,09	25	0,12
	50	0,06	50	0,10	50	0,12	50	0,14	50	0,18	50	0,20	50	0,25
	45	0,06	45	0,10	45	0,12	45	0,14	45	0,18	45	0,20	45	0,25
	45	0,06	45	0,10	45	0,12	45	0,14	45	0,18	45	0,20	45	0,25
	45	0,06	45	0,10	45	0,12	45	0,14	45	0,18	45	0,20	45	0,25
	35	0,06	35	0,10	35	0,12	35	0,14	35	0,18	35	0,20	35	0,25
	35	0,06	35	0,10	35	0,12	35	0,14	35	0,18	35	0,20	35	0,25
	80	0,08	80	0,10	80	0,12	80	0,14	80	0,18	80	0,22	80	0,26
	80	0,08	80	0,10	80	0,12	80	0,14	80	0,18	80	0,22	80	0,26
	60	0,08	60	0,10	60	0,12	60	0,14	60	0,18	60	0,22	60	0,26
	60	0,08	60	0,10	60	0,12	60	0,14	60	0,18	60	0,22	60	0,26
	70	0,10	70	0,12	70	0,14	70	0,18	70	0,20	70	0,24	70	0,30
	70	0,10	70	0,12	70	0,14	70	0,18	70	0,20	70	0,24	70	0,30
	70	0,10	70	0,12	70	0,14	70	0,18	70	0,20	70	0,24	70	0,30
	25	0,06	25	0,10	25	0,12	25	0,14	25	0,18	25	0,20	25	0,25
	25	0,06	25	0,10	25	0,12	25	0,14	25	0,18	25	0,20	25	0,25
	70	0,10	70	0,12	70	0,14	70	0,18	70	0,20	70	0,24	70	0,30
	70	0,10	70	0,12	70	0,14	70	0,18	70	0,20	70	0,24	70	0,30
	70	0,10	70	0,12	70	0,14	70	0,18	70	0,20	70	0,24	70	0,30
	25	0,06	25	0,10	25	0,12	25	0,14	25	0,18	25	0,20	25	0,25
	25	0,06	25	0,10	25	0,12	25	0,14	25	0,18	25	0,20	25	0,25
	25	0,06	25	0,10	25	0,12	25	0,14	25	0,18	25	0,20	25	0,25
	25	0,06	25	0,10	25	0,12	25	0,14	25	0,18	25	0,20	25	0,25
	25	0,06	25	0,10	25	0,12	25	0,14	25	0,18	25	0,20	25	0,25
	25	0,06	25	0,10	25	0,12	25	0,14	25	0,18	25	0,20	25	0,25
	25	0,06	25	0,10	25	0,12	25	0,14	25	0,18	25	0,20	25	0,25
	25	0,06	25	0,10	25	0,12	25	0,14	25	0,18	25	0,20	25	0,25
	25	0,06	25	0,10	25	0,12	25	0,14	25	0,18	25	0,20	25	0,25
	25	0,06	25	0,10	25	0,12	25	0,14	25	0,18	25	0,20	25	0,25
	15	0,04	15	0,05	15	0,06	15	0,07	15	0,08	15	0,09	15	0,12
	15	0,04	15	0,05	15	0,06	15	0,07	15	0,08	15	0,09	15	0,12
	15	0,04	15	0,05	15	0,06	15	0,07	15	0,08	15	0,09	15	0,12
	15	0,04	15	0,05	15	0,06	15	0,07	15	0,08	15	0,09	15	0,12
	15	0,04	15	0,05	15	0,06	15	0,07	15	0,08	15	0,09	15	0,12
	15	0,04	15	0,05	15	0,06	15	0,07	15	0,08	15	0,09	15	0,12
	12	0,04	12	0,05	12	0,06	12	0,08	12	0,08	12	0,10		
	12	0,04	12	0,05	12	0,06	12	0,08	12	0,08	12	0,10		
	8	0,04	8	0,05	8	0,06	8	0,08	8	0,08	8	0,10		
	8	0,04	8	0,05	8	0,06	8	0,08	8	0,08	8	0,10		
	12	0,04	12	0,05	12	0,06	12	0,08	12	0,08	12	0,10		

Die angegebenen Schnittwerte sind Richtwerte.

Die für den jeweiligen Bearbeitungsfall optimalen Daten sollten im Versuch oder während der Bearbeitung ermittelt werden.

AUFBOHREN UND DREHEN

Kurzklemmhalter bieten ein Höchstmaß an Flexibilität für individuelle Werkzeuglösungen. ModulBore Programm als modulare Lösung zum Aufbohren und Feinbohren.

Positive radiale Wendeschneidplatten zum Aufbohren und Drehen. Tangentiale Wendeschneidplatten für höchste Anforderungen beim Aufbohren.



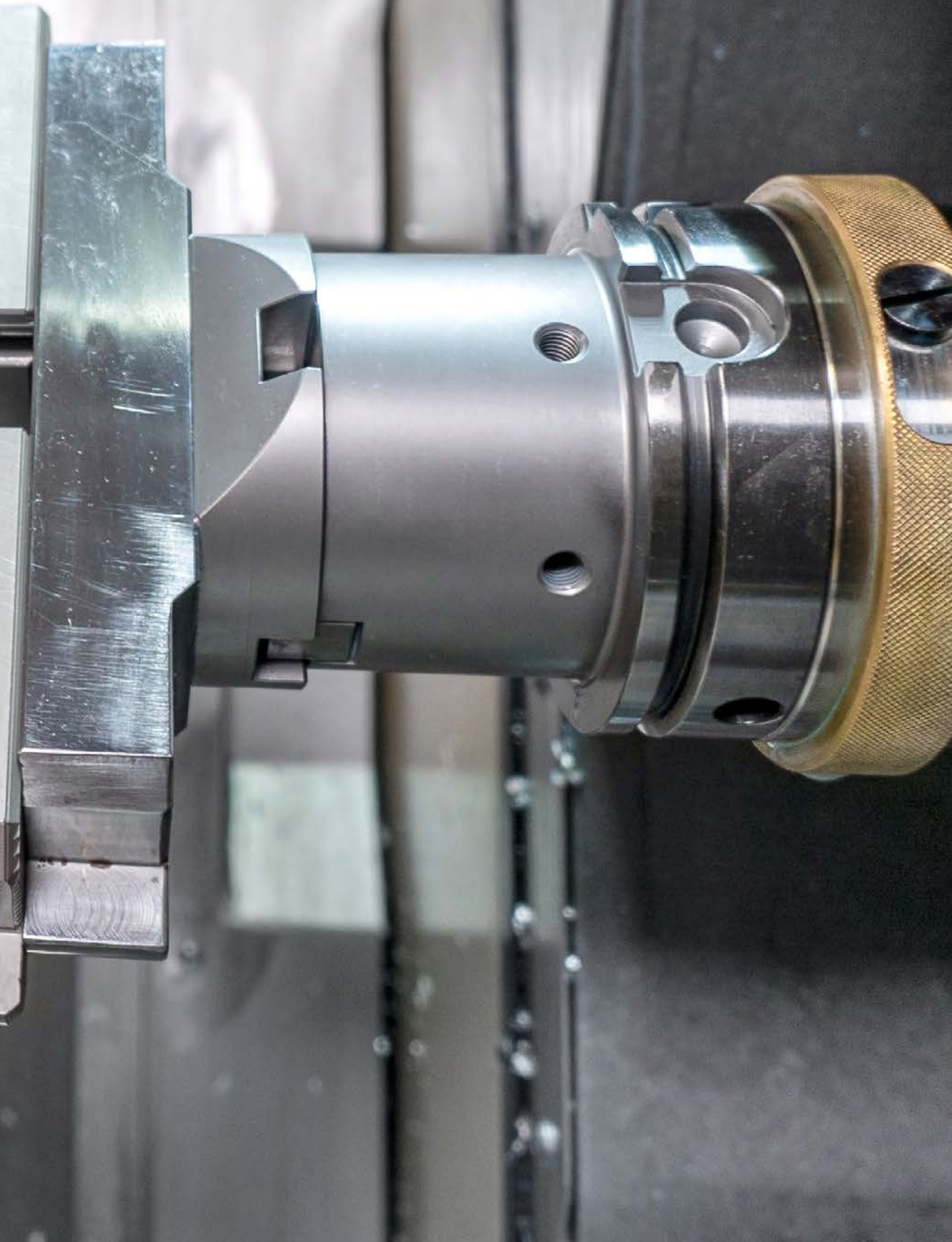

PRODUKTÜBERSICHT

Aufbohren und Drehen

MAPAL Aufbohrwerkzeuge, die den Bearbeitungsschritt zwischen Vollbohren und Feinbearbeiten übernehmen, stellen eine optimale Kombination aus Robustheit, angesichts der auftretenden Bearbeitungskräfte, und hoher Wirtschaftlichkeit dar. Durch innovative Technologie und absolute Präzision bietet MAPAL ein umfassendes Programm an Sonderwerkzeugen mit Wendeschneidplatten und fest gelöteten PKD-Schneiden. Das Verständnis für den kompletten Zerspanungsprozess und für den Produktionsanlauf insgesamt ermöglicht dabei echte Fortschritte.

Mit dem Standardprogramm ModulBore bietet MAPAL ein durchgängiges System zum Vor- und Fertigbearbeiten von Bohrungen im Durch-

messerbereich von 6 bis 1.000 mm an. Kurzklemmhalter mit ihrer einfachen Justierung, bieten zahlreiche Möglichkeiten in verschiedenen Anwendungen. Das Standardprogramm ist kompatibel mit allen gängigen ISO-Wendeschneidplatten und bildet einen Großteil der konstruktiven Einbauvarianten ab.

Das Angebot an Schneidplatten in Sonderausführung, Radial- und Tangential-Wendeschneidplatten deckt alle Anforderungen an Schneidstoffe und Beschichtungen sowie die entsprechenden Schneidengeometrien und Genauigkeiten ab. Auch für Drehanwendungen sind ausgewählte Hartmetall- und PKD-bestückte Schneidplatten verfügbar.



Sonderlösungen



Aufbohren mit PKD

- Individuelle Werkzeuglösungen für anspruchsvolle Bearbeitungsaufgaben
- Höchste Bearbeitungsqualitäten bei Maß, Oberfläche und Form
- Realisierung komplexer Schneidgeometrien
- Spiralisierte Werkzeuge für die Bearbeitung filigraner oder labiler Bauteile und Aufspannungen
- Fertigungstoleranzen von $\leq 3 \mu\text{m}$ für Werkzeugdurchmesser
- Mehrstufige Ausführung garantiert die Koaxialität bei gestuften Bohrungen
- Aufbohrwerkzeuge als Kombinationswerkzeug für reduzierte Nebenzeiten
- Für die Verwendung mit Minimalmengenschmierung (MMS) optimiert



Aufbohren mit Wendeschneidplatten

- Mehrstufige Auslegung reduziert den Werkzeugbedarf und verkürzt die Bearbeitungszeit
- Höhere Leistungsfähigkeit durch die Verwendung von Tangentialtechnologie
- Führungsleisten sorgen für eine sehr hohe Positionsgenauigkeit
- Gefederte Führungsleisten für die prozesssichere Bearbeitung großer Bohrtiefen
- Hybridwerkzeuge kombinieren verschiedene Werkzeugsysteme
- Schwingungsdämpfer sorgen bei labilen Bearbeitungssituationen oder großen Ausraglängen für eine höhere Bearbeitungsqualität und Standzeit



Schneidplatten in Sonderausführung

- Realisierung komplexer Geometrien und Konturen für nahezu alle Anwendungen
- Formschnitten für die Bearbeitung komplexer Konturen mit hoher Formgenauigkeit
- Moderne Fertigungseinrichtungen garantieren höchste Präzision und Flexibilität der MAPAL Sonderplatten
- Leistungsfähige Schneidstoffe für jeden Werkstoff
- Auch PKD- und PcBN-bestückte Schneidplatten erhältlich



Standardprogramm



ModulBore

- Durchmesserbereich von 6 bis 1000 mm
- Hohe Flexibilität durch modularen Aufbau
- Mit einem Werkzeug können größere Durchmesserbereiche bearbeitet werden
- Innere Kühlmittelzufuhr für optimale Spanabfuhr
- Erhältlich mit Feinjustierung (ModulBore-Plus)
- Stirnseitige Verzahnung garantiert ein stabiles und leistungsfähiges System
- Variante mit ISO-Kurzklemmhaltern für die Bearbeitung großer Durchmesser



Kurzklemmhalter

- Hohe Flexibilität durch schnelle und einfache Austauschbarkeit
- Justiermöglichkeit mit großem Einstellweg
- Kompatibel mit allen gängigen ISO-Wendeschneidplatten
- Sowohl für außen- als auch für innenliegende Bearbeitungen geeignet
- In verschiedenen Einbauvarianten verfügbar
- Auch als Kompaktklemmhalter mit kürzerer Baulänge verfügbar

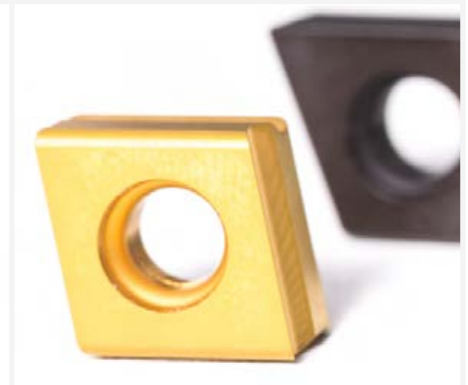

Wendeschneidplatten

- Positive Radialschneiden zum Aufbohren und Drehen
- Tangentiale Wendeschneidplatten für höchste Anforderungen
- Geschliffene und gepresste Schneiden verfügbar
- PVD- und CVD-beschichtete Schneidstoffe decken große Bandbreite zwischen Verschleißfestigkeit und Zähigkeit ab
- Bestückte Varianten mit PKD und PcBN für die hochwirtschaftliche Bearbeitung von Aluminium beziehungsweise Guss

SONDERLÖSUNGEN

Aufbohren mit PKD

Wenn es gilt große Stückzahlen an Aluminium- und Aluminiumdruckguss-Bauteilen prozesssicher und wirtschaftlich zu bearbeiten sind Sonderlösungen mit PKD-Schneiden die erste Wahl. Durch den Einsatz moderner CNC-Steuerungen und Lasertechnologie ist es heute möglich nahezu jede Schneidgeometrie prozesssicher zu fertigen – und das mit Fertigungstoleranzen von $\leq 3 \mu\text{m}$ für Werkzeugdurchmesser.

Besonders die Kombination mehrerer Bearbeitungsaufgaben in einem Werkzeug lohnt sich. Das Einsparen von Werkzeugen und Reduzieren von unproduktiven Nebenzeiten steigert die Wirtschaftlichkeit in der Produktion.

Die Herstellung einer gestuften Bohrung, bei der sämtliche Fasen und Radien zu bearbeiten sind, wird mit einem PKD-Aufbohrwerkzeug mit mehreren Stufen gelöst. Die Koaxialität der einzelnen Stufen ist damit garantiert. Auch das Bearbeiten von axialen Einstichen oder das Plansenken von Auflageflächen kann mit einem Bohrwerkzeug wirtschaftlich gelöst werden. Ebenheitsanforderungen oder Winkelgenauigkeiten lassen sich, da keine radialen Kräfte auf das Werkstück wirken, um ein Vielfaches leichter erreichen als mit herkömmlichen Dreh- oder Zirkularbewegungen.

MAPAL fertigt PKD-Werkzeuge spiralisiert mit entscheidenden Vorteilen gegenüber geradegenuteten Werkzeugen. Die Werkzeuge können flexibel auf den jeweiligen Prozess, zum Beispiel für Minimalmengenschmierung, ausgelegt werden. HSK-Ausführungen und ausrichtbare, modulare Systeme sorgen für optimale Ergebnisse.



Sonderlösungen



Polykristalliner Diamant – PKD

- PKD als Schneidstoff für Bearbeitung von Aluminium, Buntmetallen, CFK und anderen modernen Werkstoffen
- Synthetisch hergestellt aus ausgewählten Diamantpartikeln
- Gesintert bei ca. 1.500°C und ca. 60 kbar Druck
- Extrem harte und verschleißfeste Struktur
- Verschiedene Grundsubstrate ermöglichen immer die Wahl des richtigen Schneidmaterials für den jeweiligen Einsatzfall



Kompetenzzentrum PKD

- MAPAL Kompetenzzentrum für PKD-Werkzeuge in Pforzheim
- Weltweit führende Entwicklungs- und Produktionsstätte für PKD-Werkzeuge
- Hohe Qualitätsstandards in Verbindung mit hochqualifizierten Mitarbeitern garantieren erstklassige Produktionsergebnisse
- Nutzung neuester Fertigungstechnologien
- Einsatz von Lasertechnologie

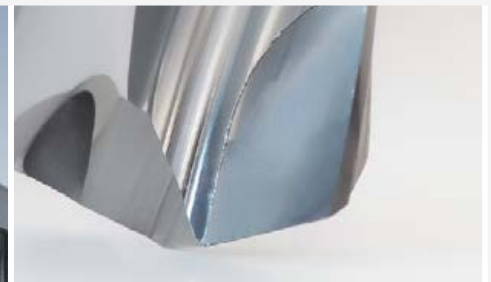

Höchste Präzision

- μm -genau geschliffene PKD-Schneiden für höchste Präzision
- Fertigungstoleranzen von $\leq 3 \mu\text{m}$ für Werkzeugdurchmesser
- Höchste Bearbeitungsqualitäten bei Maß, Oberfläche und Form
- Gelaserte Spanleitstufen, Spanteiler und Spanformer ermöglichen optimale Spanabfuhr und verhindern Spänestau
- Modularer Aufbau für höchste Rundlaufgenauigkeit
- Präzise und sichere Justierung des Rundlaufs durch axiale und radiale Verstellmöglichkeiten

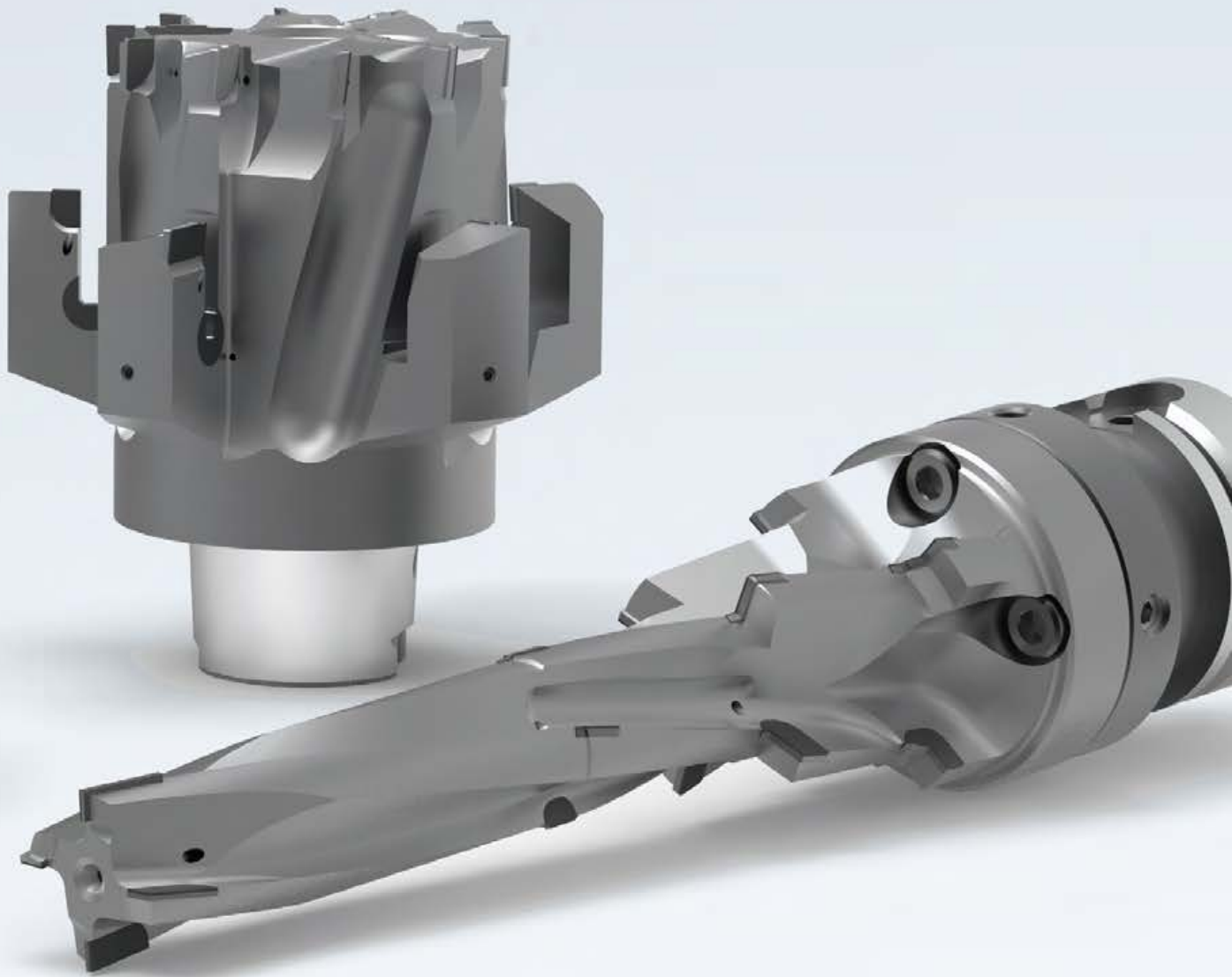

Komplexe Geometrien

- Laserbearbeitung ermöglicht präzise Fertigung hochkomplexer Schneidengeometrien sowie die Realisierung extremer Span- und Spiralwinkel
- Vorteile spiralisierter PKD-Aufbohrwerkzeuge gegenüber geradegenuteten Pendants:
 - Gutes Führungsverhalten und sehr hohe Bearbeitungsqualitäten
 - Hochpositive Spanwinkel verringern notwendige Schnittkräfte
 - Ideal für die Bearbeitung filigraner oder labiler Bauteile und Aufspannungen
 - Besserer Späneabtransport durch die Nutausführung

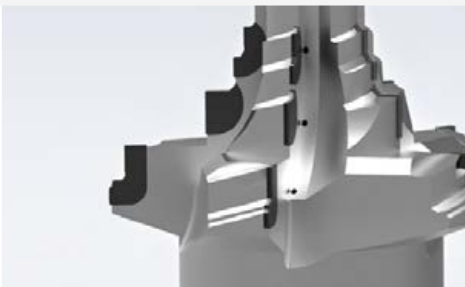

Innovative Lösungen

- Entwicklung prozesssicherer Lösungen auf Basis effizienter Zerspanungsstrategien wie beispielsweise Minimalmengenschmierung (MMS)
- Kombinationswerkzeuge reduzieren Anzahl der Prozessschritte und verkürzen Nebenzeiten
- PKD-Aufbohrwerkzeuge mit mehreren Stufen garantieren Koaxialität bei gestuften Bohrungen
- Präzise eingebettete PKD-Segmente
- Exakt auf die jeweilige Stufengeometrie abgestimmt



Wiederaufbereitung

- Wiederaufbereitung verlängert Lebensdauer der PKD-Aufbohrwerkzeuge erheblich
- Kosten für neue Werkzeuge werden eingespart
- Sofort einsatzfähige Werkzeuge
- Problemlos werden bereits bekannte Standwege erreicht
- Abholung und Anlieferung direkt vor Ort durch Paketdienst
- Standardisierter Prozess für unkomplizierte und schnelle Abwicklung innerhalb weniger Tage

SONDERLÖSUNGEN

Aufbohren mit PKD (1/2)

Anwendungsbeispiele für Sonderlösungen mit PKD

- 1 Aufbohrwerkzeug mit festgelöteten PKD-Schneidplatten und wechselbaren Standard-Wendeschneidplatten mit Einstellmöglichkeit zur Realisierung von Bohrungen mit IT6 und definierten Rauheiten
- 2 Stufenbohrwerkzeug mit einstell- und wechselbarer Rückwärtsbearbeitung zur Zerspaltung eines Differenzialgehäuses aus Aluminium
- 3 Kombinations-Aufbohrwerkzeug für die Bearbeitung einer Ölpumpe mit wechselbarem Einsteckwerkzeug aus Vollhartmetall
- 4 Mehrstufiges Aufbohrwerkzeug zur Bearbeitung eines Lenkgehäuses/Lenkrohrs aus AISi9Cu3. Dank Titangrundkörper beträgt das Werkzeuggewicht nur 5,5 kg trotz extremer Baumaße
- 5 Aufbohrwerkzeug in Leichtbauweise zur Bearbeitung einer Verdichtergrundplatte aus AISi9Cu3. Durch das niedrige Werkzeuggewicht sind hohe Schnittwerte möglich und die Spindel wird entlastet
- 6 Spiralisiertes Stufenaufbohrwerkzeug zur Bearbeitung eines Lenkgehäuses aus AISi9Cu3 mit ausrichtbarer Modulschnittstelle. Durch die spiralisierte Auslegung sehr weicher Schnitt und mechanische Späneförderung
- 7 Stufenaufbohrwerkzeug zur Bearbeitung der Lagerbohrung mit integrierter Feinjustierung für den Pilot einer Nockenwellenbohrung in einer Zylinderkopfhabe aus AISi9Cu3Fe für Prozess mit Minimalmengenschmierung

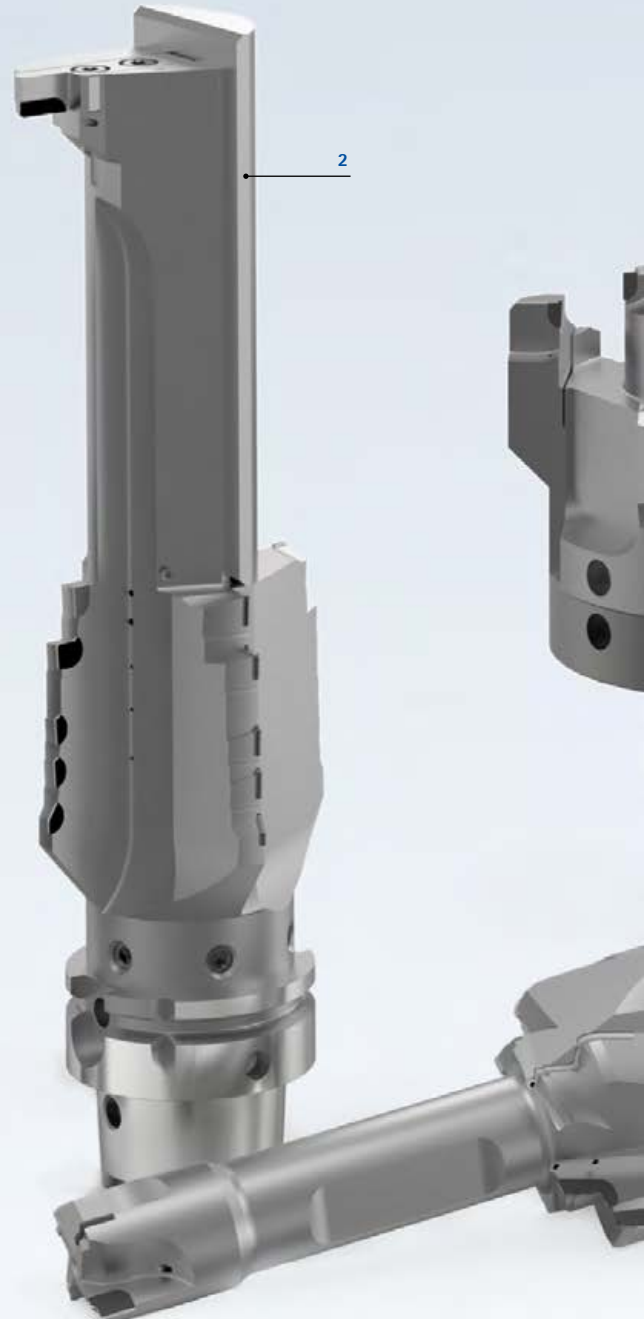

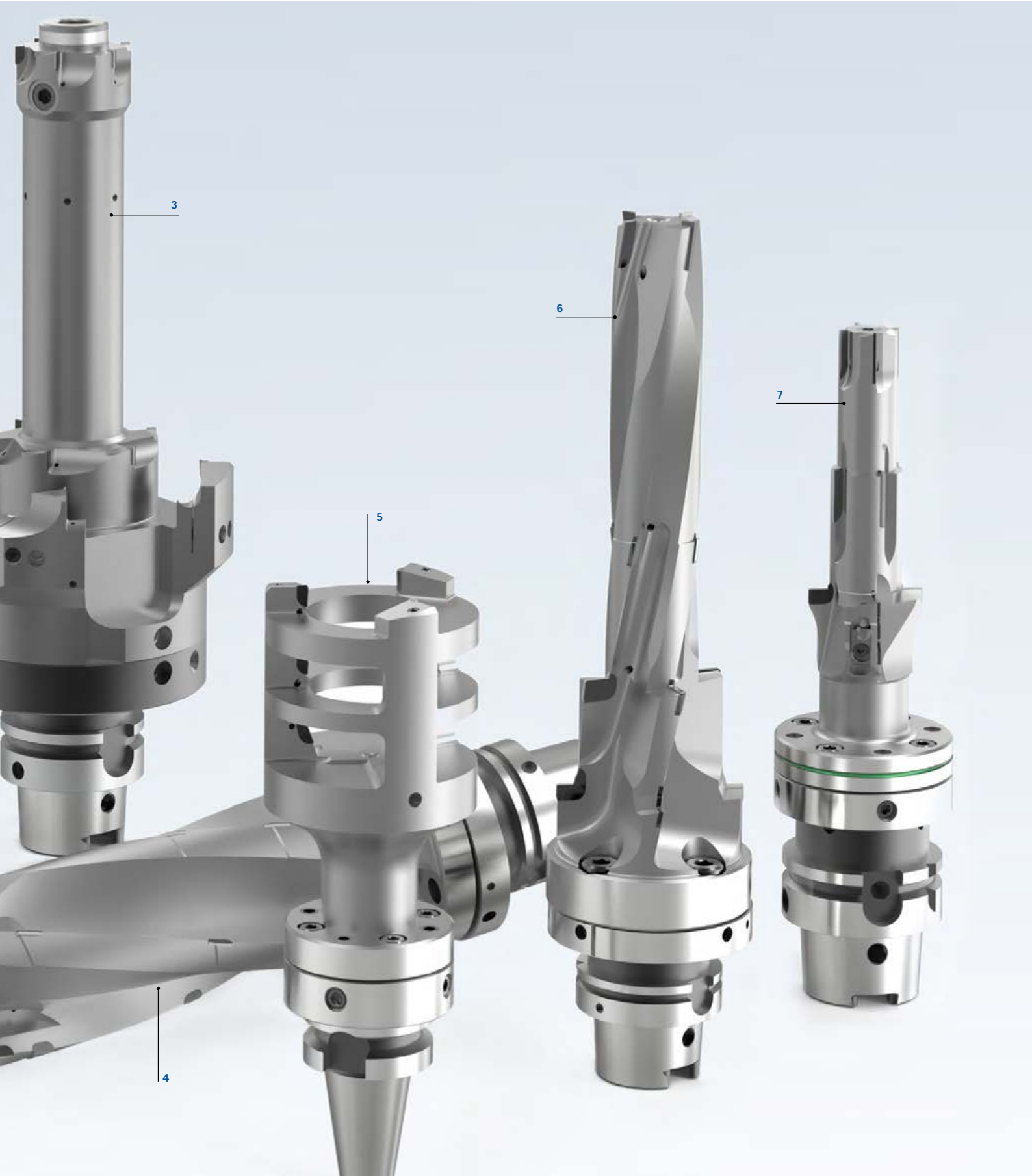

3

6

7

5

4

SONDERLÖSUNGEN

Aufbohren mit PKD (2/2)

Anwendungsbeispiele für Sonderlösungen mit PKD

- 1 Bohrfräs-Werkzeug für die Bearbeitung eines Achsschenkels (Steering knuckle) aus Aluminium. Eingebettete Schneidkanten sorgen für ratterfreie Oberflächen bei gleichzeitiger Einhaltung aller Toleranzen sowohl in der Bohr- als auch der Fräsoption
- 2 Glockenwerkzeug mit gelöteten PKD-Schneiden in Leichtbauweise zur Außenbearbeitung von Schlauchanschlüssen. Die Wabenstruktur im Inneren des Werkzeugs reduziert das Gewicht deutlich wodurch höhere Schnittdaten möglich sind. Zudem hat die Wabenstruktur eine dämpfende Wirkung, die sich positiv auf die Standzeit auswirkt
- 3 Kombinations-Bohr-Fräs-Werkzeug mit PKD-Schneiden und Wendeschneidplatten aus Hartmetall zur Bearbeitung eines Heckrahmens aus AlSiMg0.3. Die am stärksten beanspruchten Schneiden sind wechselbar ausgeführt
- 4 Spiralisiertes dreischneidiges Stufenvollbohrwerkzeug zur Bearbeitung der Schraubenbohrung einer Aluminiumfelge
- 5 „Ein-Schuss“ Werkzeuglösung mit integriertem Schwingungsdämpfer für die Bearbeitung eines Lenkungsrückmeldeaktuators
- 6 Zirkularfräser mit Schneidzahl 1+1+1 für die Bearbeitung eines Thermogehäuses aus AL380
- 7 Mehrstufiges PKD-Aufbohrwerkzeug zur „Ein-Schuss-Bearbeitung“ eines E-Motorengehäuses aus AISi9Cu3Fe in Hohlbauweise zum Einsatz auf sehr stabilen und leistungsfähigen Werkzeugmaschinen
- 8 Stufenaufbohrwerkzeug zur Innen- und Außenbearbeitung eines Getriebegehäuses aus AISi9Cu3Mg

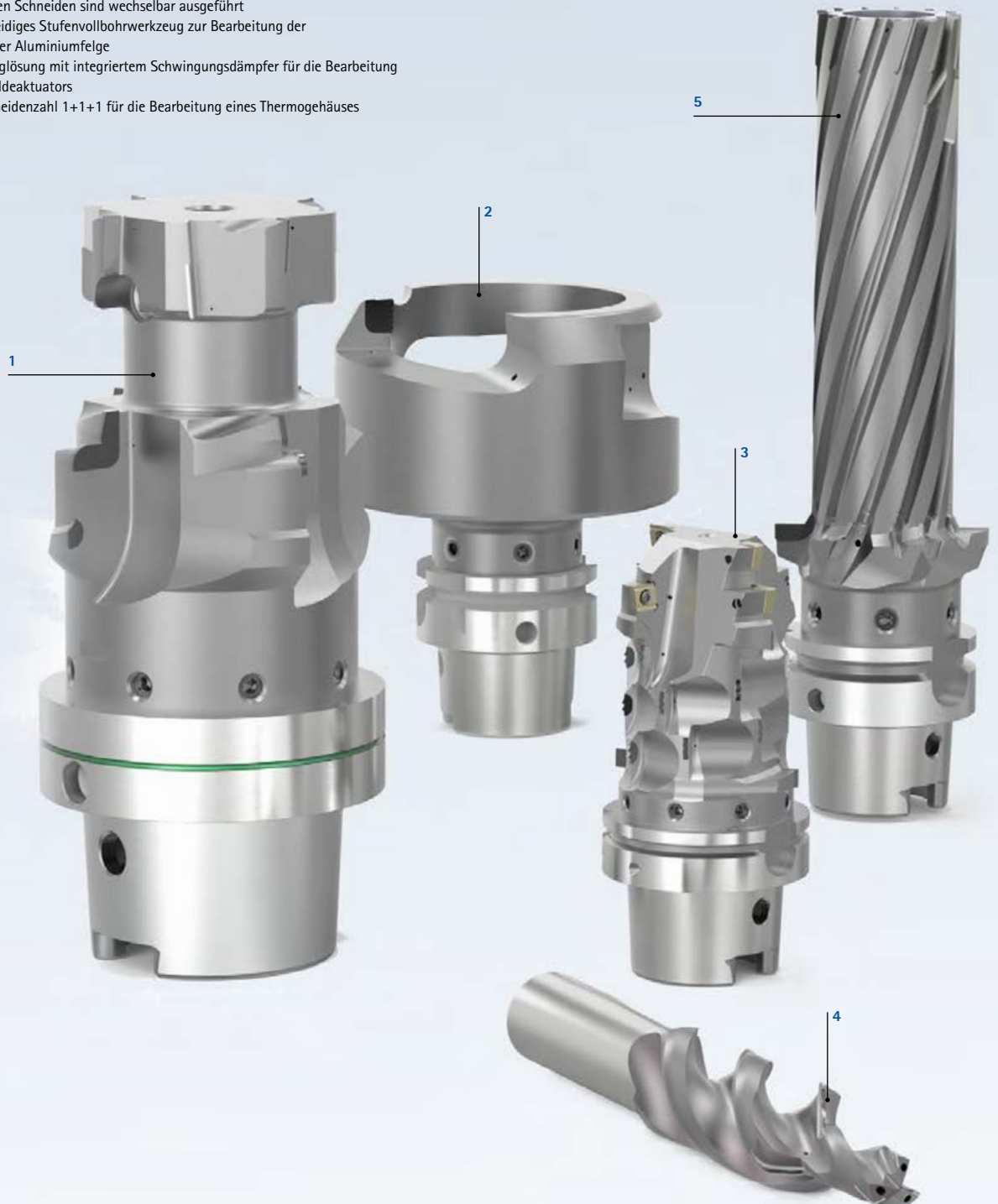



SONDERLÖSUNGEN

Aufbohren mit Wendeschneidplatten

Bei der Planung neuer Bearbeitungsprozesse sowie der Optimierung bestehender Prozesse stehen die Betrachtung der Bearbeitungszeit und der Cost-Per-Part (CPP) im Mittelpunkt. Durch intelligente, mehrstufige und mehrschneidige Kombinations- beziehungsweise Komplettbearbeitungswerkzeuge mit Wendeschneidplatten lassen sich sowohl die Hauptzeiten als auch die Nebenzeiten deutlich reduzieren. Zur Erarbeitung einer für den Kunden optimalen Lösung werden verschiedene Zerspannsysteme zu sogenannten Hybridwerkzeugen kombiniert.

Werkzeuge mit Wendeschneidplatten von MAPAL erfüllen sowohl die Anforderung an die Prozesssicherheit als auch die an ein einfaches Handling – mit intelligenten und präzisen Adapterlösungen und sicheren und schnellen Möglichkeiten der Wendeschneidplattenmontage.

Die prozesssichere Funktionsweise der Werkzeuge mit Wendeschneidplatten wird gewährleistet durch modernste Konstruktionsmethoden, die bereits in der Planungsphase Kollisionsbetrachtungen oder die Ermittlung von Störkonturen ermöglichen. Die Produktion auf modernsten Fertigungsanlagen garantiert höchste Präzision der Werkzeuge.

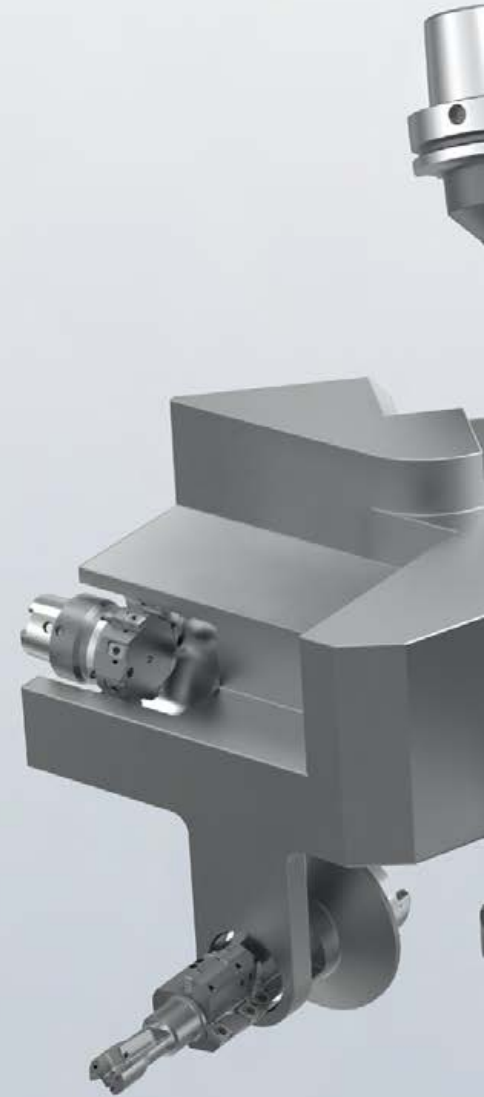

Sonderlösungen



Prozesslösungen

- Leistungsfähige Komplettbearbeitungswerkzeuge verkürzen gleichzeitig Haupt- und Nebenzeiten
- Optimierte Prozesse reduzieren Bearbeitungszeit um bis zu 60 Prozent
- Reduzierte Taktzeiten
- Weniger Energieverbrauch
- Höhere Wirtschaftlichkeit



Konstruktion und Fertigung

- Entwicklung und Auslegung von komplexen Tangentialwerkzeugen durch modernste 3D-Konstruktion und computergestützte Untersuchungen
- Exakt festgelegte Plattensitze und Spanräume
- Fertigung mit hochgenauen, leistungsfähigen 5-Achs-Bearbeitungszentren
- Überwacht und kontrolliert von erfahrenen Mitarbeitern
- Einhaltung hochgenauer Fertigungstoleranzen
- Echte Mehrschneidigkeit und hohe Leistungsfähigkeit der Werkzeuge



Modularer Aufbau

- Modulare Auslegung von Kombinationswerkzeugen mit Wendeschneidplatten
- Bearbeitung ganzer Bauteilfamilien mit wenigen Werkzeugen
- Im Verschleißfall muss nur der Teil des Werkzeuges gewechselt werden, der verschlissen ist
- Fertigungstechnisch können durch das Einbringen von Schnittstellen, zum Beispiel über eine hochgenaue HSK-C Schnittstelle, besonders komplexe Werkzeuge konstruiert werden
- Mehrere Bearbeitungsschritte in einem Werkzeug vereint
- Steigerung der Produktivität

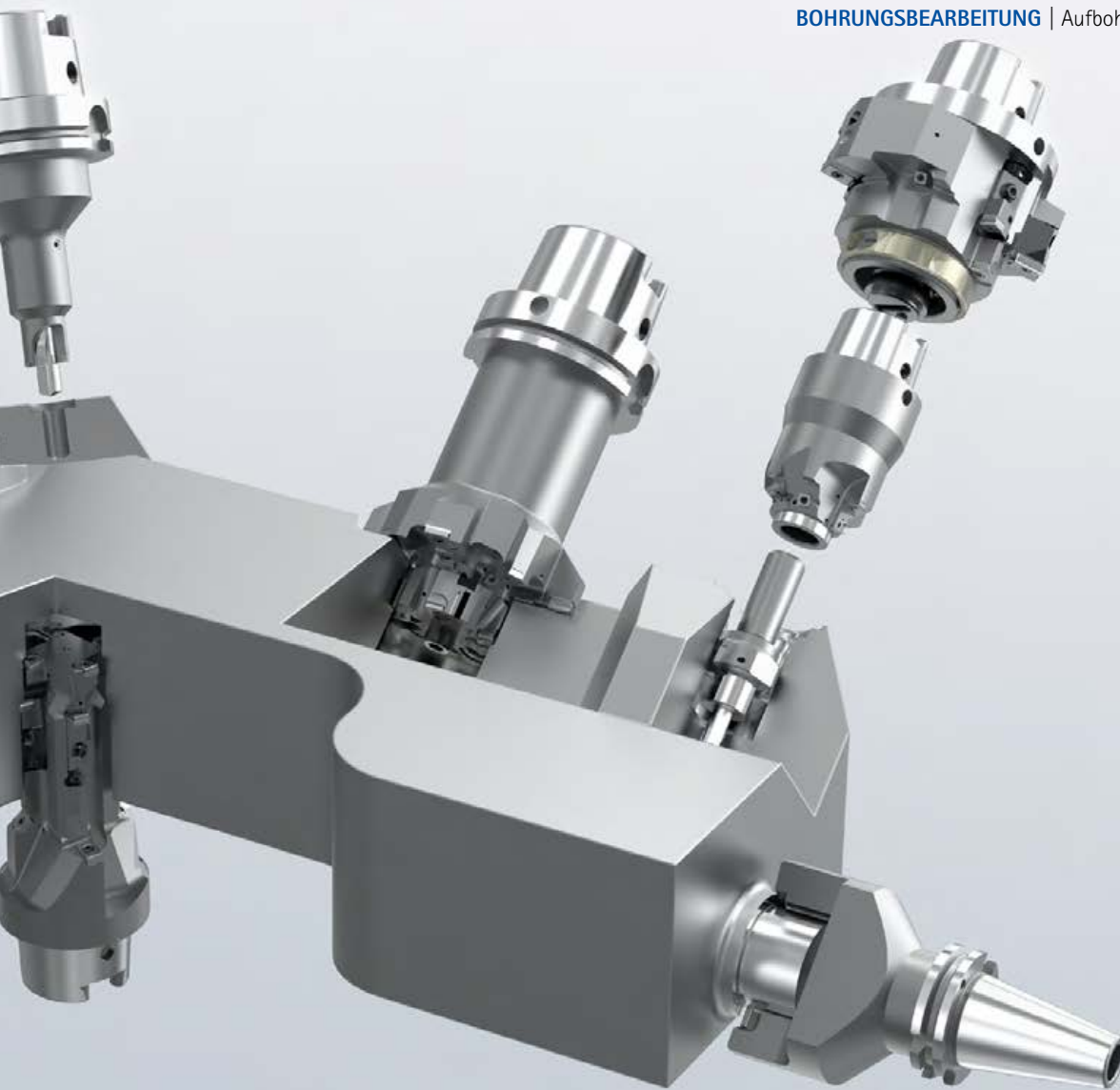

Tangentialtechnologie

- Tangentialtechnologie für hohe Leistungsfähigkeit der Aufbohrwerkzeuge mit Wendeschneidplatten
- Im Vergleich zur Verwendung von radial eingebauten Wendeschneidplatten können mehr Schneiden bei gleicher Leistungsaufnahme eingesetzt werden
- Höhere Arbeitswerte und ein größeres Zerspanvolumen
- Hohe Laufruhe
- Hervorragende Werkzeugstandzeiten und sehr gute Bauteilqualitäten



Schneiden

- Breit gefächerte Auswahl an Geometrien und Schneidstoffen
- Für jeden Anwendungsfall die richtige Schneide
- Unterschiedliche Formen und Größen
- Alle Schneidstoffe wie Hartmetall, Keramik und mit PKD beziehungsweise mit PcBN bestückte Wendeschneidplatten verfügbar
- Hohe Wirtschaftlichkeit und Ressourceneffizienz
- Optimale Nutzung des Schneidstoffs durch bis zu acht Schneidkanten

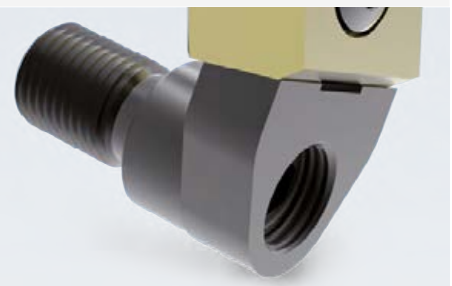

Exakte Justierung

- Speziell entwickeltes Justiersystem für hochgenaue Einstellbarkeit der Schneiden
- Stabile Auflage durch komplett in den Werkzeuggrundkörper eingebetteten Justierkeil
- Schneide liegt großflächig auf Justierkeil auf
- Justierkeil ist mit einer Schräge versehen und kann über eine Links-Rechts-Gewindeschraube bewegt werden
- Links-Rechts-Gewindeschraube sorgt für indirekte, sehr genaue und einfach zu bedienende Einstellmöglichkeit

SONDERLÖSUNGEN

Aufbohren mit Wendeschneidplatten (1/2)

Anwendungsbeispiele für Sonderlösungen mit Wendeschneidplatten

- 1 Bearbeitung der Läuferbohrung im Kompressorgehäuse aus GJL mit stirnseitigem Schwingungsdämpfer
- 2 Werkzeug mit Führungsleistentechnologie zur optimalen Abstützung in der Bearbeitung einer Spindeldurchführung einer Rundtischmaschine mit einer Länge über 1.000 mm
- 3 Kombinationswerkzeug mit Wendeschneidplatten und Einsteck-Vollhartmetallbohrer für die Bremshalterbefestigung und zur mehrstufigen Bearbeitung eines Radträgers aus GJS
- 4 Tangentialbauweise ermöglicht die komplette Senkung der Formkontur bei der Turbinenläuferbohrung im Turbolader aus hochwarmfesten Werkstoffen mit Minimalmengenschmierung
- 5 Sonderwerkzeug für die Schwenklagerbearbeitung für Schrupp- und Semi-bearbeitung, inkl. Kantenbrüchen und Einstichfräsen und zusätzlichem Einsteckbohrer
- 6 Ultra-Leichtbau-Kombinationswerkzeug mit Grundkörperteilen aus CFK Radial- und Tangential-Wendeschneidplatten zur Bearbeitung des Hauptzuges im Getriebegehäuse aus Aluminium
- 7 Kombinationswerkzeug zur mehrstufigen Bearbeitung eines Schwerlastgetriebes aus GJL



Schwingungsdämpfer ermöglichen deutlich bessere Oberflächengüten bei der Bearbeitung. Die Auslegung erfolgt individuell auf die je-weilige Bearbeitungsaufgaben abgestimmt.

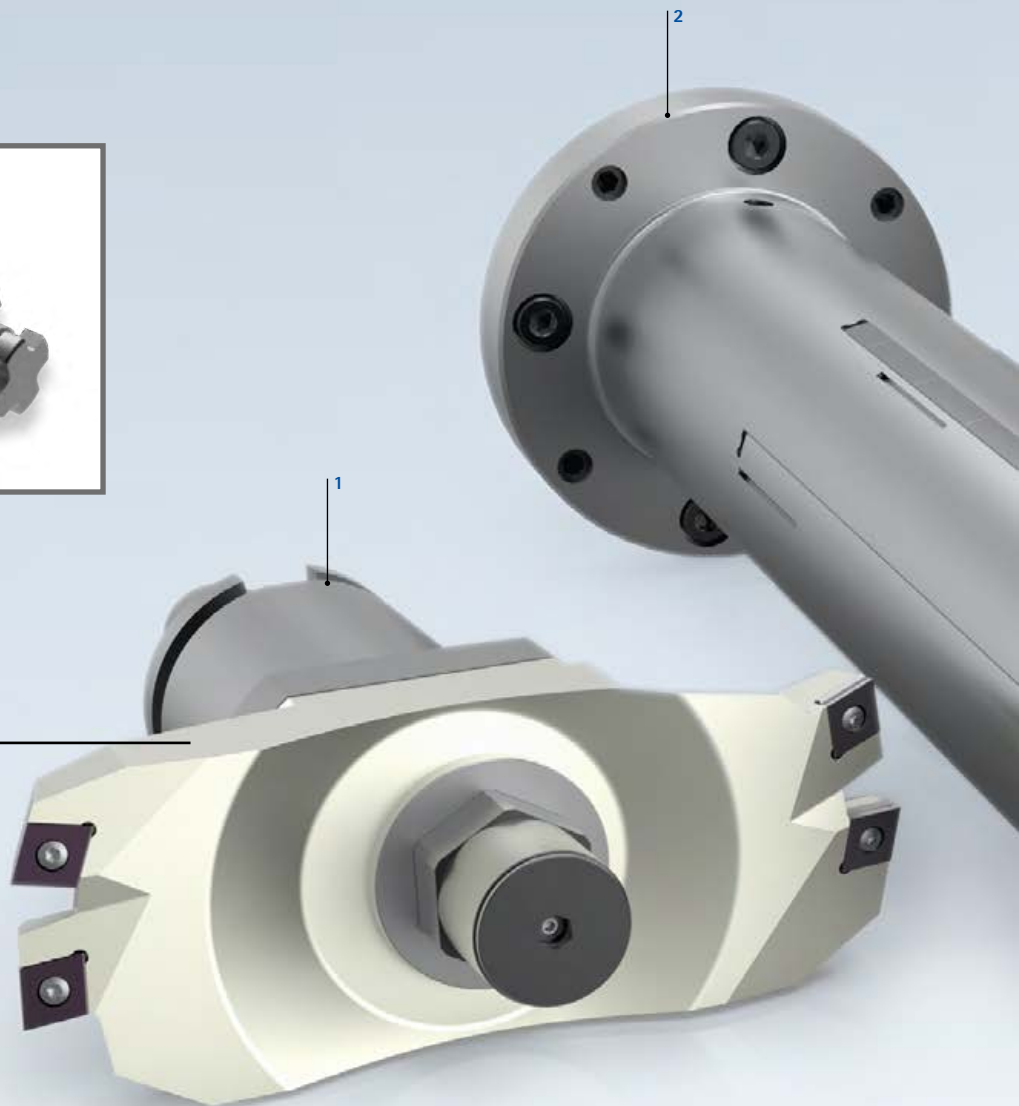



SONDERLÖSUNGEN

Aufbohren mit Wendeschneidplatten (2/2)

Anwendungsbeispiele für Sonderlösungen mit Wendeschneidplatten

- 1 Interpolationsdrehwerkzeug mit Formplatten und kontinuierlichem Schnittverlauf für die Bearbeitung der Einstichkontur V-Band-Anschluss eines Turbinengehäuses (Turbolader).
- 2 Vor- und Semifinishbearbeitung der Hauptbohrung des Turbinengehäuses (Turbolader). Sechs Bearbeitungsmerkmale und ein Kontrollschnitt werden mit nur einem Werkzeug gefertigt.
- 3 Kombinationswerkzeug mit Tangential-Wendeschneidplatten und Führungsleisten aus Cermet und PKD.
- 4 Fertigbearbeitung von Turbinen- und Verdichtergehäusen mit mechatronischem Aussteuerwerkzeug TOOLTRONIC®.
- 5 Bearbeitung der Hauptbohrung mit ISO-Kombinationswerkzeug, das die Bearbeitungsschritte Einstechen, Feinbohren und Senken kombiniert.





SONDERLÖSUNGEN

Schneidplatten in Sonderausführung

Um komplexe Konturen mit hoher Formgenauigkeit rationell zu bearbeiten, werden häufig Formschnneiden eingesetzt.

MAPAL bietet für diese Schnneiden alle Möglichkeiten in Bezug auf Form, Schneidstoff und Beschichtung. Moderne Fertigungseinrichtungen garantieren höchste Präzision und Flexibilität der MAPAL Schneidplatten in Sonderausführung.

Auch PKD- und PcBN-bestückte Schneidplatten sind in dieser Vielfalt erhältlich. Eingebaut in die hochgenauen Plattensitze der MAPAL Werkzeuge, erzielen sie beste Resultate, sowohl in wirtschaftlicher als auch in qualitativer Hinsicht.





VORTEILE

- Hohe Prozesssicherheit bei konturabhängigen Formen und Geometrien
- Einsparung aufwendiger Bearbeitungsfolgen
- Mehrschneidigkeit bei Fertigung von komplexen Konturen





ModulBore

Hohe Flexibilität beim Aufbohren und Feinbohren

Mit dem Aufbohrprogramm ModulBore bietet MAPAL ein durchgängiges System zum Vor- und Fertigbearbeiten von Bohrungen im Durchmesserbereich von sechs bis 1.000 mm.

Das System ist durch seinen modularen Aufbau sehr flexibel und für die jeweilige Bearbeitungsaufgabe konfigurierbar. Für die Schruppbearbeitung stehen zweischneidige Aufbohrwerkzeuge zur Verfügung. Dank einer stirnseitigen Verzahnung, auf der die Schneidhalter aufgenommen sind, sind die Werkzeuge sehr stabil und leistungsfähig. Der Einsatz von Wendschneidplatten mit positiver Grundgeometrie, gedrahte Spanräume sowie die innere Kühlmittelzufuhr gewährleisten ein breites Anwendungsfeld, hohe Arbeitssicherheit und einfaches Handling.

Die ModulBore-Feinbohrköpfe sind bereits ab einem Durchmesser von sechs mm erhältlich. Sie zeichnen sich durch ihre hohe Präzision und ihren robusten Aufbau aus, sind einfach in der Handhabung und verfügen ebenfalls über eine innere Kühlmittelzufuhr. Die Feinjustierung der Köpfe erfolgt in beiden Stellrichtungen sehr genau ohne „Stick-Slip-Effekt“ (Haft-Gleit-Effekt).

Das ModulBore-Programm wird individuell an die kundenspezifischen Anforderungen angepasst und ist daher nicht ab Lager verfügbar.

ModulBore

Einführung	614
Systemübersicht	618
ModulBore - Aufbohren	620
ModulBore - Feinbohren	627
Adapter	636

ModulBore – Aufbohren

Ø 22 – 115 mm

Zweischneider mit ModulBore-System (MBS) in sieben Abmessungen für Schneidplattenhalter (WSP-Kassetten).

Ø 87 – 202 mm

Aufbohrköpfe als Brückenkonstruktion. Aufgeteilt auf fünf Brücken für Schneidplattenhalter (WSP-Kassetten).

Ø 200 – 520 mm

Aufbohrköpfe als Brückenkonstruktion. Aufgeteilt auf vier Brücken zur Bestückung mit Schlitten für handelsübliche ISO-Kurzklemmhalter.

Ø 358 – 1.000 mm

Aufbohrköpfe als Brückenkonstruktion (Großausdrehbereich). Aufgeteilt auf acht Brücken zur Bestückung mit Schlitten für handelsübliche ISO-Kurzklemmhalter.



* Notwendige Bestellmenge: 2 Stück

Aufbohrwerkzeuge



Zweischneider mit MBS

Für die Schruppbearbeitung im Durchmesserbereich von 22 bis 115 mm stehen zweischneidige Aufbohrwerkzeuge zur Verfügung. Durch eine stirnseitige Verzahnung, auf der die Schneidplattenhalter aufgenommen sind, ist das System sehr stabil und leistungsfähig. Der Einsatz von Wendschneidplatten mit positiver Grundgeometrie, gedallte Spanräume sowie die innere Kühlmittelzufuhr gewährleisten ein breites Anwendungsfeld, hohe Arbeitssicherheit und einfaches Handling.

Die Zweischneider sind sowohl als modulares Werkzeug, als auch als Monoblock-Werkzeug mit HSK- oder SK-Schnittstelle erhältlich.

* Notwendige Bestellmenge: 2 Stück



Aufbohrköpfe mit Brückenmodul und ISO-Kurzklemmhalter

Die Aufbohrköpfe mit Brückenmodul sind im Bereich von 87 bis 1.000 mm erhältlich. Die Brückenmodule sind ab einem Durchmesser von 200 mm mit ISO-Kurzklemmhaltern bestückt, die auf Schlitten mit Verzahnung stirnseitig auf den Brücken geführt werden. Zur Gewichtoptimierung werden die Brückenmodule im Durchmesserbereich von 358 bis 1.000 mm in Aluminium ausgeführt.

ModulBore – Feinbohren

Ø 10 – 28 mm

Feinbohrköpfe mit Bohrstange

Ø 14 – 23 mm

Feinbohrstange

Ø 21 – 115 mm

Feinbohrkopf mit MBS

Ø 87 – 202 mm

Feinbohrköpfe als Brückenkonstruktion. Aufgeteilt auf vier Brücken zur Bestückung mit Schlitten für ModulBore Feinbohr-Kurzklemmhalter.

Ø 200 – 520 mm

Feinbohrköpfe als Brückenkonstruktion. Aufgeteilt auf vier Brücken zur Bestückung mit Schlitten für ModulBore Feinbohr-Kurzklemmhalter.

Ø 358 – 1.000 mm

Feinbohrköpfe als Brückenkonstruktion (Großausdrehbereich). Aufgeteilt auf acht Brücken zur Bestückung mit Schlitten für ModulBore Feinbohr-Kurzklemmhalter.



Feinbohrwerkzeuge



Feinbohrkopf mit Bohrstange

Die ModulBore Feinbohrköpfe sind bereits ab einem Durchmesser von sechs mm im Programm. Sie zeichnen sich durch hohe Präzision und robusten Aufbau aus, sind einfach in der Handhabung und haben ebenfalls eine innere Kühlmittelzufuhr. Die Feinjustierung der Köpfe erfolgt in beiden Stellrichtungen sehr genau ohne „Stick-Slip-Effekt“.

Die Feinbohrköpfe sind sowohl als modulares Werkzeug, als auch als Monoblock-Werkzeug mit HSK- oder SK-Schnittstelle erhältlich.



Feinbohrköpfe mit Brückenmodul und Feinbohr-Kurzklemmhalter

Ab Durchmesser 87 mm sind die Feinbohrköpfe mit Brückenmodul ausgeführt. Auf den Brückenmodulen sitzen Schlitten, die mit justierbaren Feinbohr-Kurzklemmhaltern bestückt sind. Bei größeren Durchmessern werden die Brückenwerkzeuge einschneidig ausgeführt. Der gegenüberliegende Schlitten dient dem Unwuchtausgleich. Zur Gewichtsoptimierung werden die Brückenmodule im Durchmesserbereich von 358 bis 1.000 mm aus Aluminium gefertigt.

ModulBore-Plus – Feinbohren

Die ModulBore-Plus Werkzeuge mit Feinjustierung zeichnen sich durch einen einfachen und präzisen Einstellmechanismus aus. Dieser ermöglicht eine definierte, fehlerfreie Zustellung direkt auf der Maschine mittels Standard-Torxschlüssel. Die hohe Genauigkeit und die einfache Handhabung reduzieren die Nebenzeiten beim Feinbohren, erhöhen die Qualität und steigern die Produktivität.

MODULBORE-PLUS

- **Feinjustierung:**
2 µm pro Teilstrich bezogen auf den Durchmesser
- **Umkehrfehler:**
< 2 µm

VORTEILE

- Fehlerfrei ablesbar (kein Nonius erforderlich)
- kein „Stick-Slip-Effekt“
- Wartungsarm
- Einbaufreundlich
- Langlebig und robust: Drei Jahre Garantie

Feinbohrstange

Die ModulBore-Plus Feinbohrstange eignet sich für den Einsatz in der Serien- und Großserienfertigung und bietet dabei maximale Standzeiten.

Feinbohrkopf

Der zuverlässige ModulBore-Plus Feinbohrkopf ist für das Feinbohren von der Prototypenfertigung bis hin zu Großserien geeignet. Die zusätzliche Grobeinstelleinheit verschafft dem Bohrkopf einen variablen Aktionsradius von bis zu 9 mm. Das gesamte Programm ermöglicht Bohrbearbeitungen für Durchmesser von 21 bis 115 mm.

Feinbohr-Kurzklemmhalter

Die ModulBore-Plus Feinbohr-Kurzklemmhalter sind für den Einsatz in ein- oder mehrschneidigen Sonderwerkzeugen oder in Feinbohr-Brücken für den Großausbohrbereich ausgelegt. Sie erfordern keine Anpassung der Maschinenspindel.

ModulBore-Plus Werkzeugsysteme

Feinbohrstange ø 14 bis 23 mm



Feinbohrkopf ø 21 bis 115 mm



Feinbohr-Kurzklemmhalter



ModulBore - Adapter

MBS-Schnittstelle

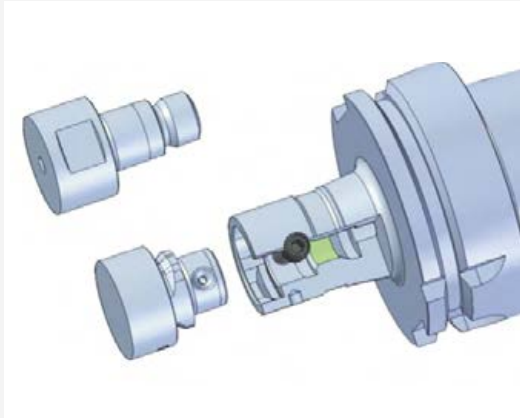

Die MBS-Schnittstelle ist das zentrale Merkmal des ModulBore-Systems. Durch die Bajonettkupplung, die einen Zylinder-Plananlagekontakt bewirkt, werden hohe Drehmomentkräfte übertragen. Zwei radiale Spannschrauben ermöglichen eine Vorspannung der Kupplung und eine Rotation des Werkzeuges in beide Richtungen.

VORTEILE

- Einfaches Handling, problemlose Montage und Demontage
- Hochpräzise Bajonettkupplung mit Schneidenorientierung
- Hohe Rundlaufgenauigkeit durch Planflächenanlage
- Innere Kühlmittelzufuhr über die Schnittstelle zur Schneide
- Kompatibel mit Starflex RFX

MBS-Adapter



Die MBS-Adapter bieten die Möglichkeit vom maschinenseitigen Anschluss auf den MBS-Anschluss zu adaptieren. Somit kann das umfangreiche ModuleBore-Programm unbegrenzt genutzt werden. Im Standardprogramm sind die gängigen Anschlüsse wie Hohlenschaftkegel (HSK) und diverse Steilkegel (SK/BT) in vielen Nenngrößen und Nennlängen enthalten. MBS-Verlängerungen und -Reduzierungen erhöhen zudem die Flexibilität des Systems. Weitere Adapter können als Sonderwerkzeuge gefertigt werden.

Aufsteckdorne



Die Kombi-Aufsteckdorne/-Quernutdorne sind die Grundlage für viele Variationsmöglichkeiten der ModulBore-Brückenwerkzeuge. Das Standardprogramm bietet die gängigen Anschlüsse wie Hohlenschaftkegel (HSK), diverse Steilkegel (SK/BT) und MBS in vielen Nenngrößen und Nennlängen. Darüber hinaus können weitere Maschinenanschlüsse wie zum Beispiel KM nach DIN ISO 26622 als Kombi-Aufsteckfräsdorn mit den Brückenwerkzeugen bestückt werden.

ModulBore - Systemübersicht

ModulBore | Adapter

MBS-Adapter

Seite 636 - 638

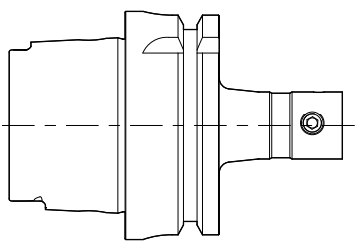
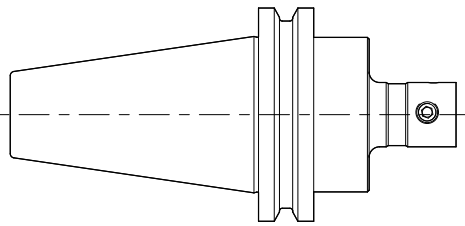
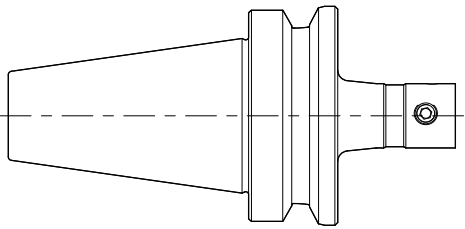

MBS-Verlängerungen

Seite 639

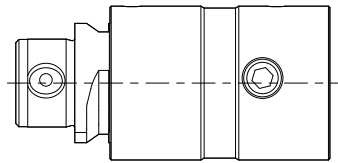

MBS-Reduzierungen

Seite 640

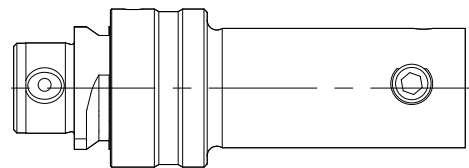

MBS-Quernutdorne

Seite 641

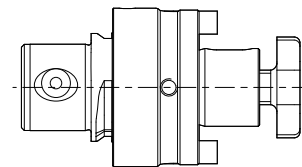

Aufsteckdorne

siehe Katalog SPANNEN

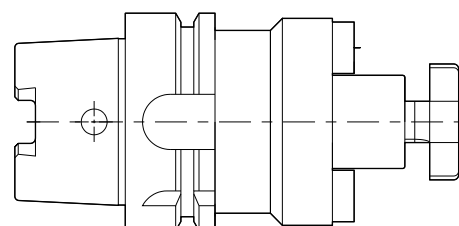

► MBS-Schnittstelle

► Aufsteckdorn

ModulBore | Aufbohren

Zweischneider mit MBS

Seite 620

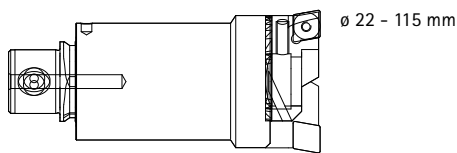

Auch als Monoblockwerkzeug erhältlich!

Aufbohrkopf mit Brückenmodul

Seite 622

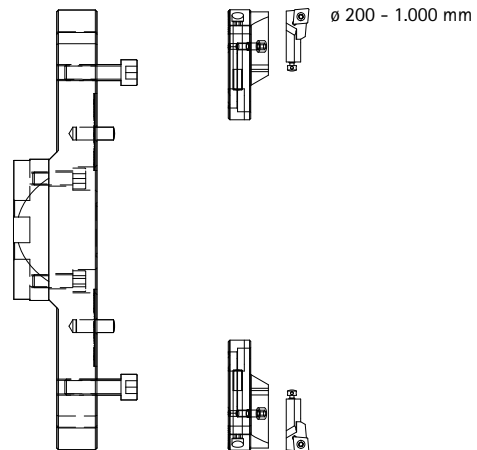
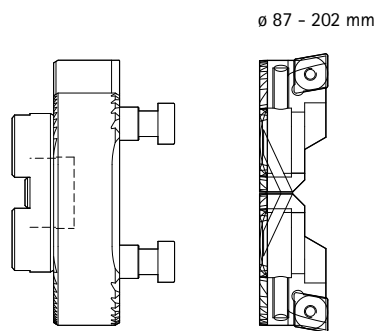

ModulBore | Feinbohren

ModulBore-Feinbohrkopf mit MBS

Seite 627

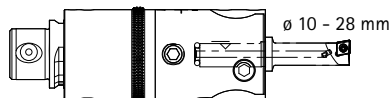
Auch als Monoblockwerkzeug
mit HSK/SK Schnittstelle erhältlich!**ModulBore-Plus Feinbohrkopf mit MBS**

Seite 630

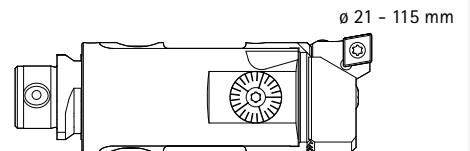
**ModulBore-Feinbohrkopf mit Brückenmodul**

Seite 631

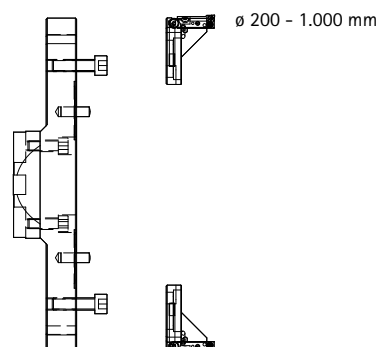
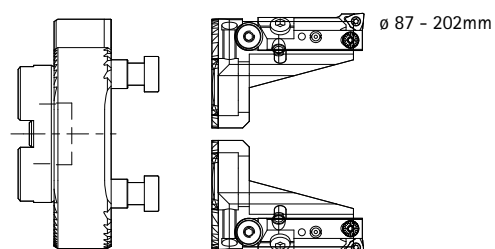

ModulBore - Zweischneider mit MBS

Aufbohrwerkzeug für die Schruppbearbeitung, Grundkörper ohne WSP-Kassetten
 Ø 22 - 115 mm

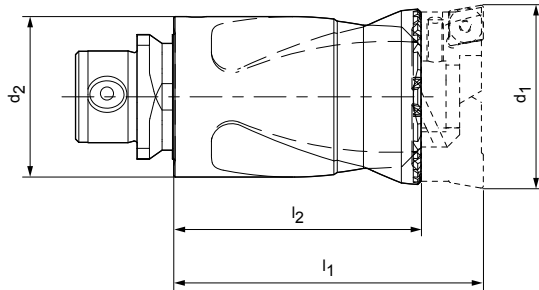

d ₁ min. - max.	d ₂ MBS-Größe	l ₁	l ₂	sw	Spezifikation	Bestell-Nr.
22 - 30	18,5	40	27,7	17	MBO100-022030-Z2-MBS185	30415217
30 - 39	24,5	50	37,7	22	MBO100-030039-Z2-MBS254	30415218
39 - 50	32	65	48,7	27	MBO100-039050-Z2-MBS320	30415219
50 - 67	42	90	68,2	36	MBO100-050067-Z2-MBS420	30415220
67 - 88	55	115	90,7	46	MBO100-067088-Z2-MBS550	30415221
88 - 115	72	150	113,7	60	MBO100-088115-Z2-MBS720	30415222

Lieferzeit auf Anfrage.

Beispiel

Systemübersicht – Zweischneider mit MBS

Ø 22 - 115 mm

MBS-Adapter

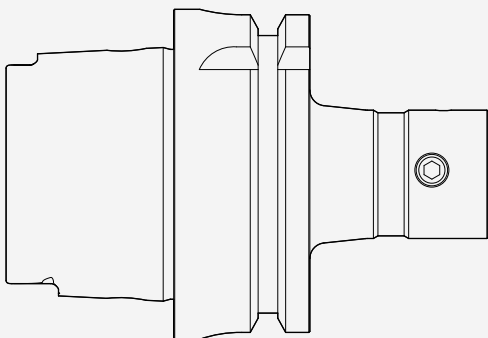

Zweischneider mit MBS

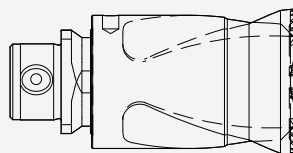

WSP-Kassetten
(Plattenhalter)



ModulBore - WSP-Kassetten für Zweischneider

Ø 22 - 115 mm

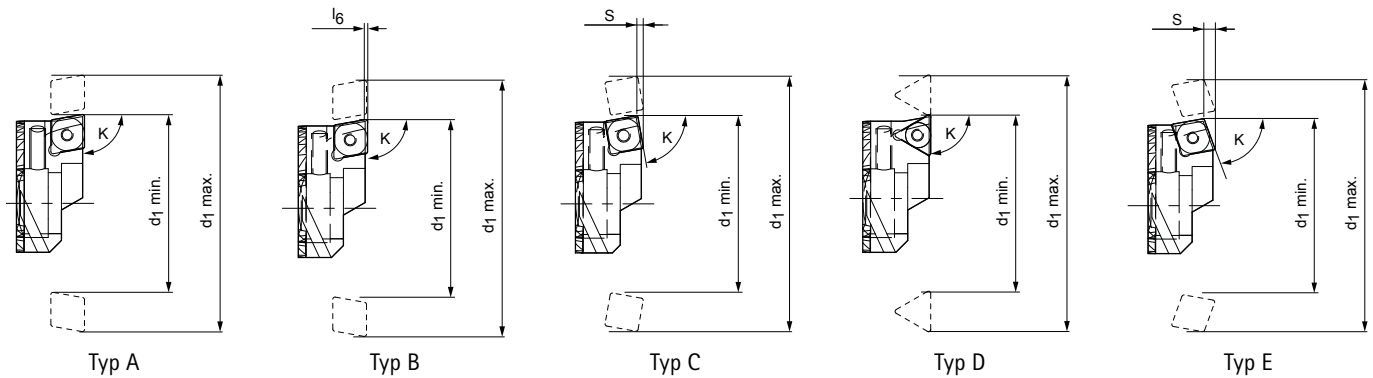

d_1 min. - max.	Typ	K	Höhenversatz l_6	S	WSP	Spezifikation	Bestell-Nr.
22 - 30	A	90°			CC/CP.. 0602	IC-MBO100-022030-A90-C_06	30415185
	B	90°	0,3		CC/CP.. 0602	IC-MBO100-022030-B90-C_06	30415186
	E	70°		2	CC/CP.. 0602	IC-MBO100-022030-E70-C_06	30415187
30 - 39	A	90°			CC/CP.. 0602	IC-MBO100-030039-A90-C_06	30415188
	B	90°	0,3		CC/CP.. 0602	IC-MBO100-030039-B90-C_06	30415189
	C	80°		2	SP.. 0703	IC-MBO100-030039-C80-S_07	30415190
	E	70°		2	CC/CP.. 0602	IC-MBO100-030039-E70-C_06	30415191
39 - 50	A	90°			CC/CP.. 09T3	IC-MBO100-039050-A90-C_09	30415192
	B	90°	0,3		CC/CP.. 09T3	IC-MBO100-039050-B90-C_09	30415193
	C	80°		1,5	SC/SP.. 09T3	IC-MBO100-039050-C80-S_09	30415194
	D	90°			TC/TP.. 09T3	IC-MBO100-039050-D90-T_09	30415195
	E	70°		3,1	CC/CP.. 09T3	IC-MBO100-039050-E70-C_09	30415196
50 - 67	A	90°			CC/CP.. 1204	IC-MBO100-050067-A90-C_12	30415197
	B	90°	0,3		CC/CP.. 1204	IC-MBO100-050067-B90-C_12	30415198
	C	80°		2,1	SC/SP.. 09T3	IC-MBO100-050067-C80-S_09	30415199
	D	90°			TC/TP.. 09T3	IC-MBO100-050067-D90-T_09	30415200
	E	70°		4,1	CC/CP.. 1204	IC-MBO100-050067-E70-C_12	30415201
67 - 88	A	90°			CC/CP.. 1204	IC-MBO100-067088-A90-C_12	30415202
	B	90°	0,3		CC/CP.. 1204	IC-MBO100-067088-B90-C_12	30415203
	C	80°		2,1	SC/SP.. 1204	IC-MBO100-067088-C80-S_12	30415204
	D	90°			TNM.. 16T3	IC-MBO100-067088-D90-T_16	30415205
	E	70°		4,1	CC/CP.. 1204	IC-MBO100-067088-E70-C_12	30415206
88 - 115	A	90°			CC/CP.. 1204	IC-MBO100-088115-A90-C_12	30415207
	B	90°	0,3		CC/CP.. 1204	IC-MBO100-088115-B90-C_12	30415208
	C	80°		2,5	SC/SP.. 1204	IC-MBO100-088115-C80-S_12	30415209
	D	90°			TNM.. 2204	IC-MBO100-088115-D90-T_22	30415210
	E	70°		4,1	CC/CP.. 1204	IC-MBO100-088115-E70-C_12	30415211

Notwendige Bestellmenge: 2 Stück

Lieferzeit auf Anfrage.

ModulBore - Aufbohrkopf mit Brückenmodul

Aufbohrwerkzeug für die Schruppbearbeitung, Werkzeugkörper ohne WSP-Kassetten
 Ø 87 - 202 mm

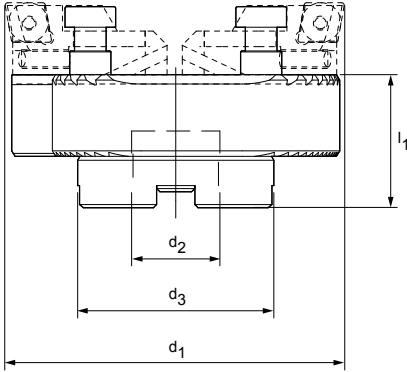

d_1 min. - max.	d_2	d_3	l_1	Spezifikation	Bestell-Nr.
87 - 110	27	61,5	42	MB0110-087110-Z2-CA27	30415224
109 - 133	27	61,5	42	MB0110-109133-Z2-CA27	30415225
132 - 156	27	62	42	MB0110-132156-Z2-CA27	30415226
155 - 179	27	62	42	MB0110-155179-Z2-CA27	30415227
178 - 202	27	62	42	MB0110-178202-Z2-CA27	30415228

Lieferzeit auf Anfrage.

Beispiel

Systemübersicht - Aufbohrkopf mit Brückenmodul

Ø 87 - 202 mm

MBS-Adapter

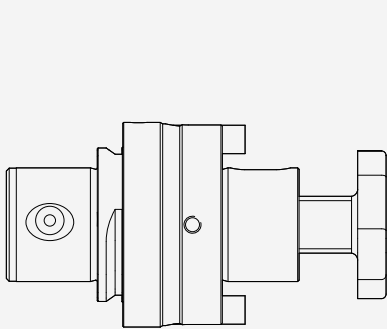

Brückenmodul

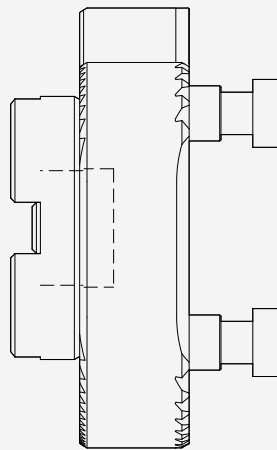

WSP-Kassetten
(Plattenhalter)

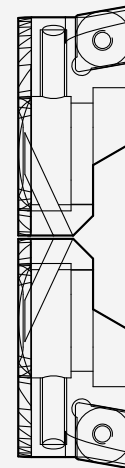

ModulBore - WSP-Kassetten für Zweischneider

Ø 87 - 202 mm

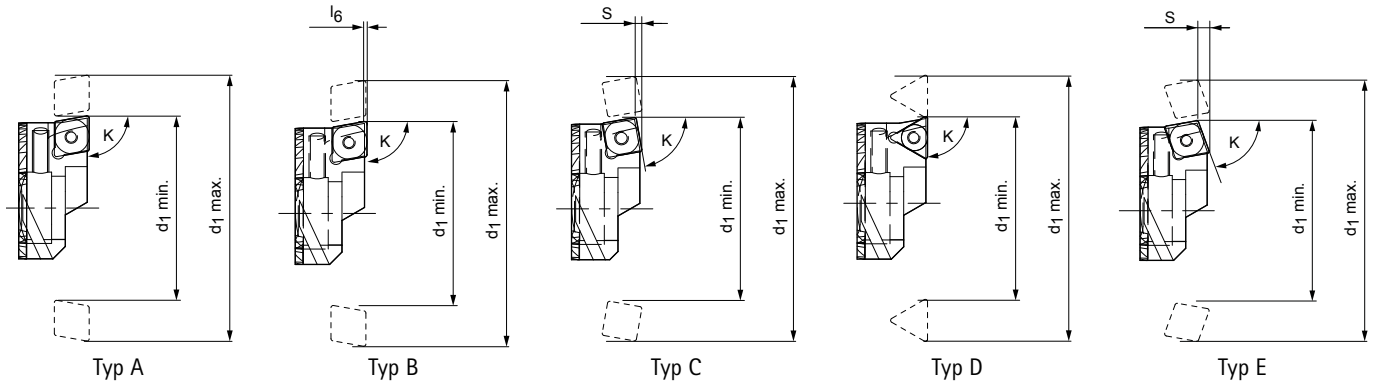

d_1 min. - max.	Typ	K	Höhenversatz l_6	S	WSP	Spezifikation	Bestell-Nr.
87 - 202	A	90°			CC/CP.. 1204	IC-MBO100-067088-A90-C_12	30415202
	B	90°	0,3		CC/CP.. 1204	IC-MBO100-067088-B90-C_12	30415203
	C	80°		2,1	SC/SP.. 1204	IC-MBO100-067088-C80-S_12	30415204
	D	90°			TNM.. 16T3	IC-MBO100-067088-D90-T_16	30415205
	E	70°			4,1	CC/CP.. 1204	IC-MBO100-067088-E70-C_12

Notwendige Bestellmenge: 2 Stück
Lieferzeit auf Anfrage.

ModulBore – Aufbohrkopf mit Brückenmodul

Aufbohrwerkzeug für die Schruppbearbeitung, ohne Schlitten und Kurzklemmhalter
 Ø 200 - 520 mm

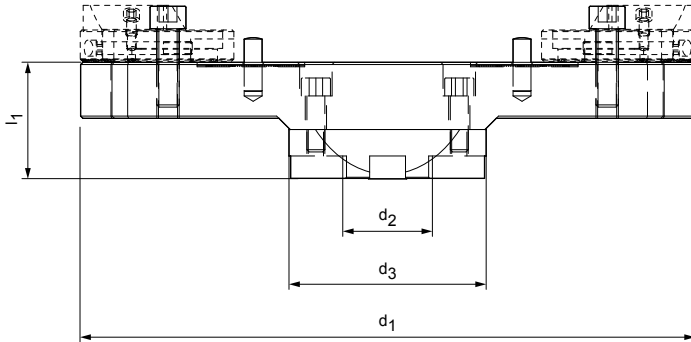

d ₁ min. - max.	d ₂	d ₃	l ₁	Spezifikation	Bestell-Nr.
200 - 280	40	88	51	MB0120-200280-Z2-CA40	30415229
280 - 360	40	88	51	MB0120-280360-Z2-CA40	30415230
360 - 440	40	88	61	MB0120-360440-Z2-CA40	30415231
440 - 520	40	88	61	MB0120-440520-Z2-CA40	30415232

Lieferzeit auf Anfrage.

ModulBore – Aufbohrkopf mit Brückenmodul

Aufbohrwerkzeug für die Schruppbearbeitung, verstärkte Ausführung aus Aluminium, ohne Schlitten und Kurzklemmhalter
 Ø 358 - 1.000 mm

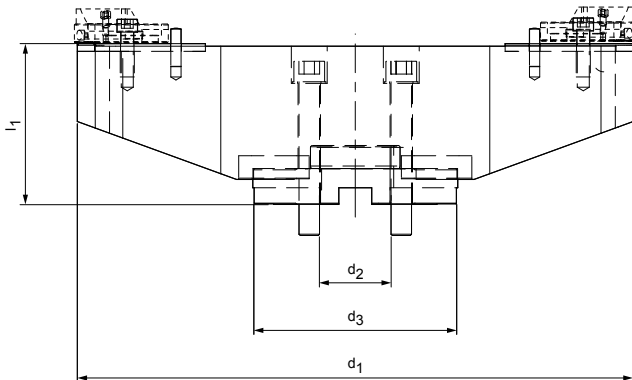

d ₁ min. - max.	d ₂	d ₃	l ₁	Spezifikation	Bestell-Nr.
358 - 440	60	130	91	MB0130-358440-Z2-CA60	30415233
438 - 520	60	130	126	MB0130-438520-Z2-CA60	30415234
518 - 600	60	130	126	MB0130-518600-Z2-CA60	30415235
598 - 680	60	130	126	MB0130-598680-Z2-CA60	30415236
678 - 760	60	130	126	MB0130-678760-Z2-CA60	30415237
758 - 840	60	130	126	MB0130-758840-Z2-CA60	30415238
838 - 920	60	130	126	MB0130-838920-Z2-CA60	30415239
918 - 1000	60	130	126	MB0130-918000-Z2-CA60	30415240

Lieferzeit auf Anfrage.

Maßangaben in mm.

ModulBore – Schlitten für ISO-Kurzklemmhalter

Ø 200 - 1.000 mm

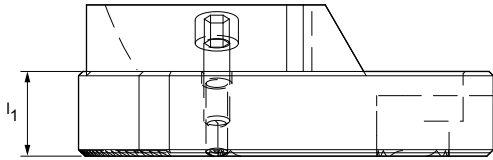

Für Werkzeug-Ø d ₁	l ₁	Spezifikation	Bestell-Nr.
200 - 1.000	19,4	SL-MBO140-2001000	30415309

Lieferzeit auf Anfrage.

ModulBore – ISO-Kurzklemmhalter

Ø 200 - 1.000 mm

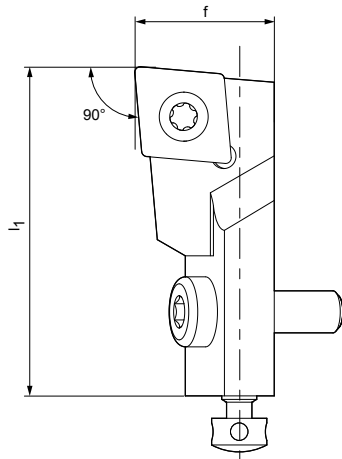

Typ A

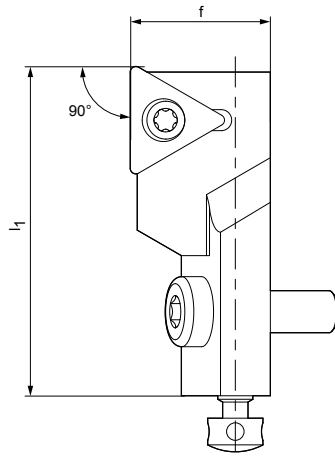

Typ B

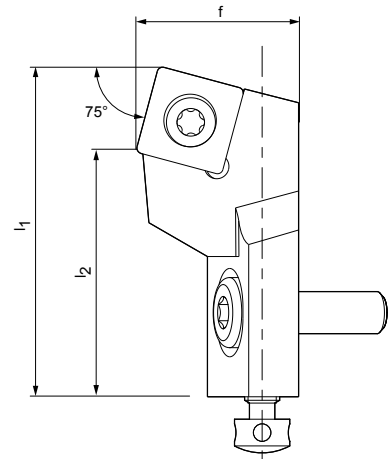

Typ C

Typ	f	l ₁	l ₂	Wendeschneid- platten	Spezifikation	Bestell-Nr.
A	20	47	-	CC...1204	SCLCL12CA-12	30011071
B	20	47	-	TC16T3	STGCL12CA-16	30011077
C	20	47	35,409	SC...1204	SSRCL12CA-12	30011103

Lieferzeit auf Anfrage.

Zubehör siehe Seite 660.

Maßangaben in mm.

Beispiel

Systemübersicht – Aufbohrkopf mit Brückenmodul

Ø 200 - 1.000 mm

Adapter

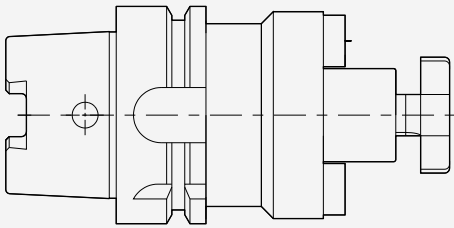

Brückenmodul

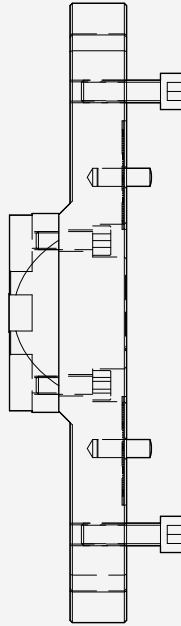

Schlitten + ISO-Kurzklemmhalter

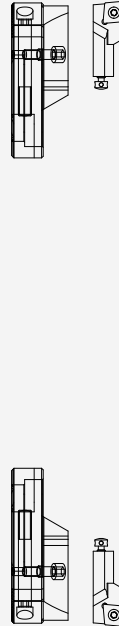

ModulBore – Feinbohrkopf

Ausdrehwerkzeug für die Feinbearbeitung, Werkzeugkörper ohne Bohrstange
 Ø 10 - 28 mm

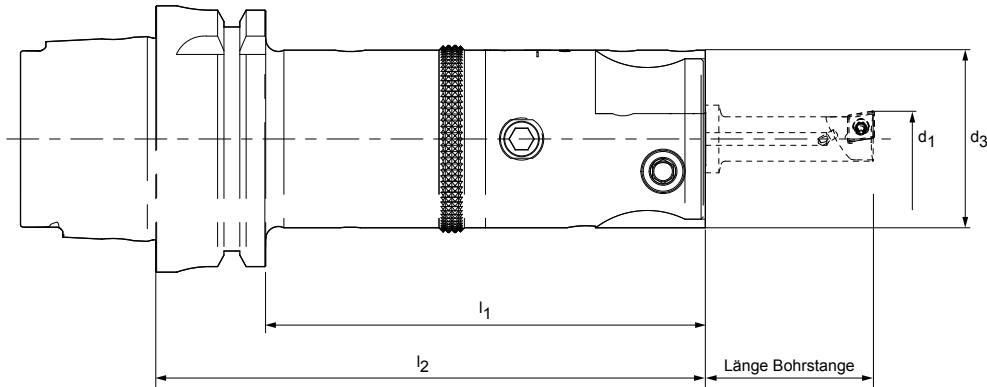

d_1 min. - max.	Schaft	d_3	l_1	l_2	Spezifikation	Bestell-Nr.
10 - 28	MBS	42		95	MBO201-006028-Z1-MBS420	30415248
	MAS BT40	42	76	103	MBO201-006028-Z1-BT040	30415241
	SK40	42	84	103	MBO201-006028-Z1-SK040	30415249
	HSK-A40	42	110	130	MBO201-006028-Z1-HSK-A040	30415242
	HSK-A50	42	104	130	MBO201-006028-Z1-HSK-A050	30415243
	HSK-A63	42	104	130	MBO201-006028-Z1-HSK-A063	30415244
	HSK-A80	42	104	130	MBO201-006028-Z1-HSK-A080	30415245
	HSK-A100	42	101	130	MBO201-006028-Z1-HSK-A100	30415246
	KM40	42		100	MBO201-006028-Z1-KM40	30415247

Grobverstellung $d_1 = 3 \text{ mm}$ | Feinverstellbereich $d_1 = 0,4 \text{ mm}$
 Lieferzeit auf Anfrage.

Beispiel

MBS Systemübersicht – Feinbohrkopf

Ø 10 - 28 mm

Adapter

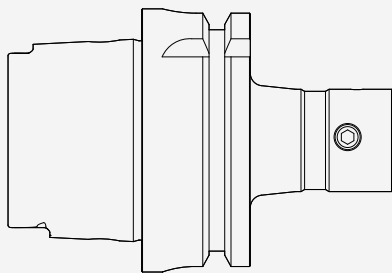

Feinbohrkopf mit MBS

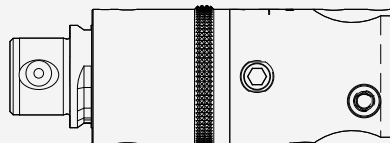

Bohrstange

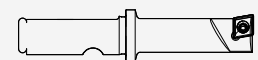

ModulBore – Bohrstangen für Feinbohrkopf

Bohrstange für Feinbohrkopf, mit innerer Kühlmittelzufuhr

Ø 10 - 28 mm

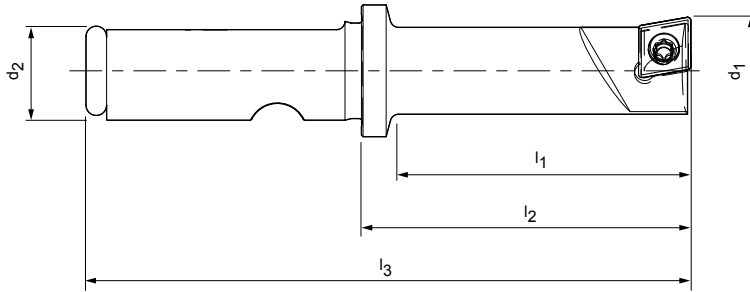

d_1 min. - max.	d_2	l_1	l_2	l_3	WSP	Spezifikation	Bestell-Nr.
10 - 13	12	30	35	70	CC.. 0602	MB0211-010013-Z1-22	30415260
13 - 16	12	35	40	75	CC.. 0602	MB0211-013016-Z1-22	30415261
16 - 19	12	40	45	80	CC.. 0602	MB0211-016019-Z1-22	30415262
19 - 22	12	50	55	90	CC.. 0602	MB0211-019022-Z1-22	30415263
22 - 25	12	60	65	100	CC.. 0602	MB0211-022025-Z1-22	30415264
25 - 28	12	70	75	110	CC.. 0602	MB0211-025028-Z1-22	30415265

Lieferzeit auf Anfrage.

ModulBore-Plus – Feinbohrstange

Ausspindelwerkzeug für die Feinbearbeitung, mit innerer Kühlmittelzufuhr
 Ø 14 - 23 mm

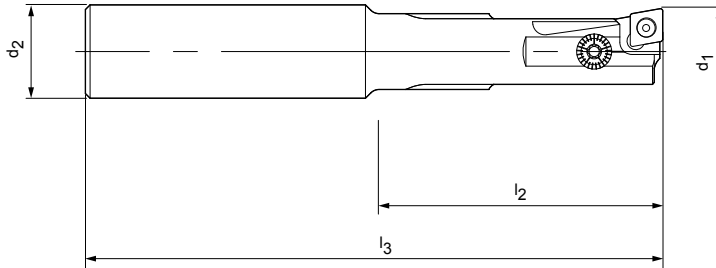

d ₁	d ₂	l ₂	l ₃	WSP	Spezifikation	Bestell-Nr.
14,0	16	48	99	CC.. 0602	MB0311-0140-Z1-WC16	30415266
14,5	16	48	99	CC.. 0602	MB0311-0145-Z1-WC16	30415267
15,0	16	48	99	CC.. 0602	MB0311-0150-Z1-WC16	30415268
15,5	16	48	99	CC.. 0602	MB0311-0155-Z1-WC16	30415269
16,0	20	54	107	CC.. 0602	MB0311-0160-Z1-WC20	30415270
16,5	20	54	107	CC.. 0602	MB0311-0165-Z1-WC20	30415271
17,0	20	54	107	CC.. 0602	MB0311-0170-Z1-WC20	30415272
17,5	20	54	107	CC.. 0602	MB0311-0175-Z1-WC20	30415273
18,0	20	60	113	CC.. 0602	MB0311-0180-Z1-WC20	30415274
18,5	20	60	113	CC.. 0602	MB0311-0185-Z1-WC20	30415275
19,0	20	60	113	CC.. 0602	MB0311-0190-Z1-WC20	30415276
19,5	20	60	113	CC.. 0602	MB0311-0195-Z1-WC20	30415277
20,0	20	70	125	CC.. 0602	MB0311-0200-Z1-WC20	30415278
20,5	20	70	125	CC.. 0602	MB0311-0205-Z1-WC20	30415279
21,0	20	70	125	CC.. 0602	MB0311-0210-Z1-WC20	30415280
21,5	20	70	125	CC.. 0602	MB0311-0215-Z1-WC20	30415281
22,0	20	70	125	CC.. 0602	MB0311-0220-Z1-WC20	30415282
22,5	20	70	125	CC.. 0602	MB0311-0225-Z1-WC20	30415284
23,0	20	70	125	CC.. 0602	MB0311-0230-Z1-WC20	30415283

Verstellbereich Nenndurchmesser d₁ $\begin{matrix} +0,3 \text{ mm} \\ -0,1 \text{ mm} \end{matrix}$

Lieferzeit auf Anfrage.

ModulBore-Plus - Feinbohrkopf mit MBS

Ausspindelwerkzeug für die Feinbearbeitung, mit innerer Kühlmittelzufuhr
 Ø 21 - 115 mm

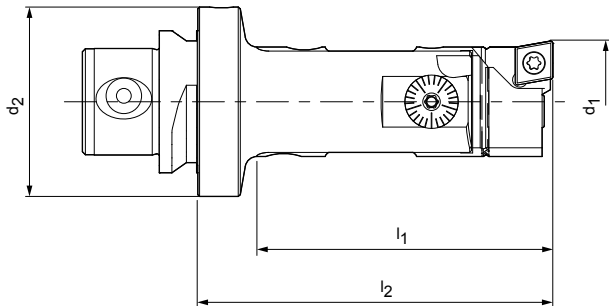

Auf Anfrage erhältlich

d_1 min. - max.	d_2 MBS-Größe	l_1	l_2	WSP	Spezifikation	Bestell-Nr.
21 - 29	32	50	60	CC.. 0602	MBO401-021029-Z1-MBS320	30415285
29 - 39	24,5	65	65	CC.. 0602	MBO401-029039-Z1-MBS245	30415286
38 - 50	32	75	75	CC.. 0602	MBO401-038050-Z1-MBS320	30415287
50 - 65	42	95	95	CC.. 0602	MBO401-050065-Z1-MBS420	30415289
65 - 88	55	120	120	CC.. 0602	MBO401-065088-Z1-MBS550	30415291
88 - 115	72	150	150	CC.. 0602	MBO401-088115-Z1-MBS720	30415294

Grobverstellung d_1 siehe Tabelle | Feinverstellbereich $d_1 = 0,4$ mm
 Lieferzeit auf Anfrage.

ModulBore - Feinbohrkopf mit Brückenmodul

Ausspindelwerkzeug für die Feinbearbeitung, ohne Schlitten und Feinbohrkurzklemmhalter

Ø 87 - 202 mm

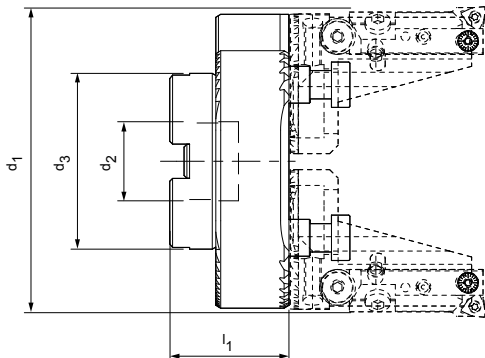

d_1 min. - max.	d_2	d_3	l_1	Spezifikation	Bestell-Nr.
87 - 110	27	61,5	42	MBO110-087110-Z2-CA27	30415224
109 - 133	27	61,5	42	MBO110-109133-Z2-CA27	30415225
132 - 156	27	62	42	MBO110-132156-Z2-CA27	30415226
155 - 179	27	62	42	MBO110-155179-Z2-CA27	30415227
178 - 202	27	62	42	MBO110-178202-Z2-CA27	30415228

Lieferzeit auf Anfrage.

ModulBore - Schlitten für Feinbohrkurzklemmhalter

Ø 87 - 202 mm

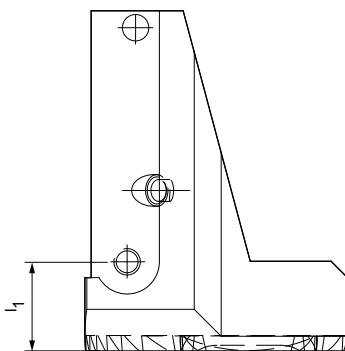

Für Werkzeug-Ø d_1	l_1	Spezifikation	Bestell-Nr.
87 - 202	16,9	SL-MB0150-087202	30415310

Lieferzeit auf Anfrage.

Beispiel

Systemübersicht – Feinbohrkopf mit Brückenmodul

Ø 87 - 202 mm

Adapter

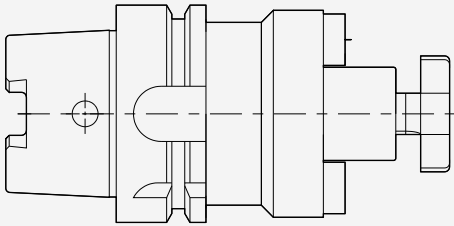

Brückenmodul

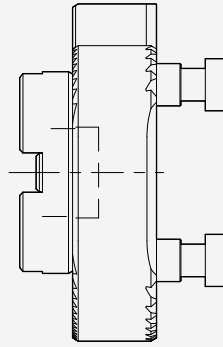

Schlitten + Feinbohrkurzklemhalter

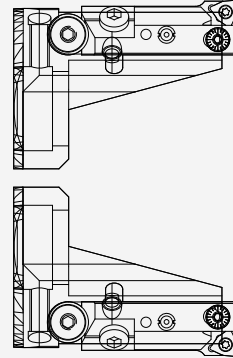

ModulBore - Feinbohrkopf mit Brückenmodul

Ausspindelwerkzeug für die Feinbearbeitung, ohne Schlitten und Feinbohrkurzklemmhalter
 Ø 200 - 520 mm

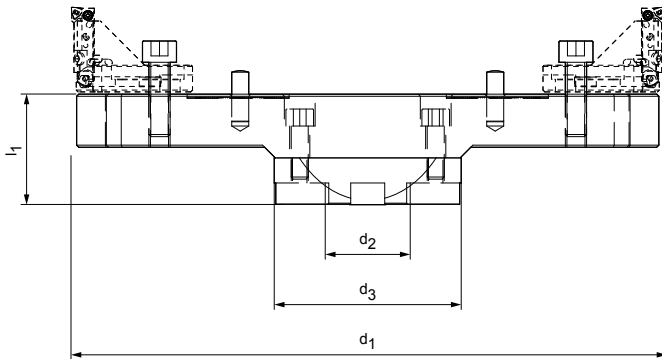

d_1 min. - max.	d_2	d_3	l_1	Spezifikation	Bestell-Nr.
200 - 280	40	88	51	MB0120-200280-Z2-CA40	30415229
280 - 360	40	88	51	MB0120-280360-Z2-CA40	30415230
360 - 440	40	88	61	MB0120-360440-Z2-CA40	30415231
440 - 520	40	88	61	MB0120-440520-Z2-CA40	30415232

Lieferzeit auf Anfrage.

ModulBore - Feinbohrkopf mit Brückenmodul

Aufbohrwerkzeug für die Feinbearbeitung, verstärkte Ausführung aus Aluminium, ohne Schlitten und Feinbohr-Kurzklemmhalter

Ø 358 - 1.000 mm

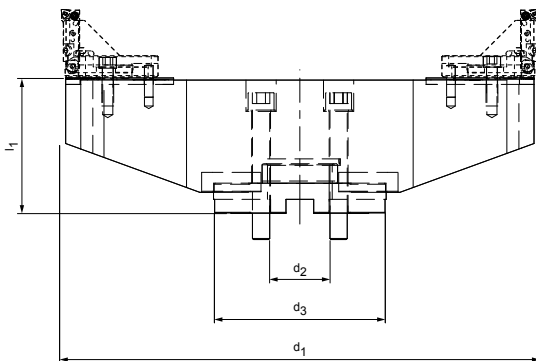

d_1 min. - max.	d_2	d_3	l_1	Spezifikation	Bestell-Nr.
358 - 440	60	130	91	MB0130-358440-Z2-CA60	30415233
438 - 520	60	130	126	MB0130-438520-Z2-CA60	30415234
518 - 600	60	130	126	MB0130-518600-Z2-CA60	30415235
598 - 680	60	130	126	MB0130-598680-Z2-CA60	30415236
678 - 760	60	130	126	MB0130-678760-Z2-CA60	30415237
758 - 840	60	130	126	MB0130-758840-Z2-CA60	30415238
838 - 920	60	130	126	MB0130-838920-Z2-CA60	30415239
918 - 1.000	60	130	126	MB0130-918000-Z2-CA60	30415240

Lieferzeit auf Anfrage.

Maßangaben in mm.

ModulBore – Schlitten für Feinbohrkurzklemmhalter

Ø 200 - 1.000 mm

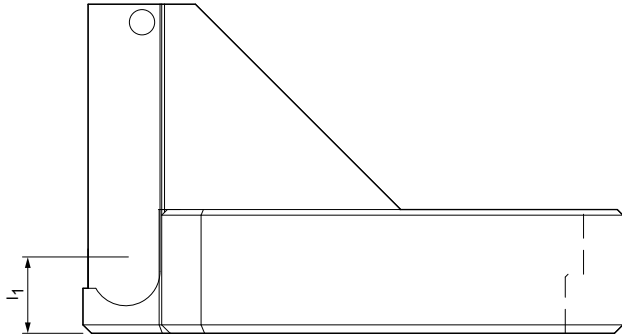

Für Werkzeug-Ø d_1	l_1	Spezifikation	Bestell-Nr.
200 - 1.000	13,1	SL-MBO150-2001000	30415311

Passendes Ausgleichsgewicht bei einschneidiger Spindelbearbeitung Bestell-Nr. 30522418.
Lieferzeit auf Anfrage.

Beispiel

Systemübersicht – Feinbohrkopf mit Brückenmodul

Ø 200 - 1.000 mm

Adapter

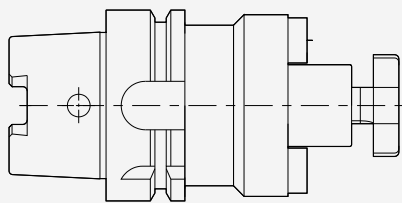

Brückenmodul

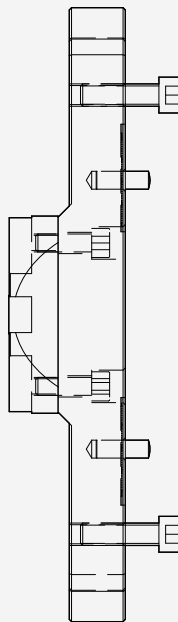

Schlitten + Feinbohrkurzklemmhalter + Ausgleichsgewicht

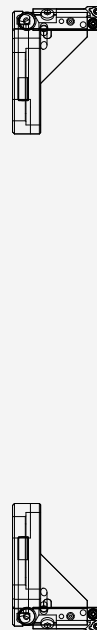

ModulBore – Feinbohrkopfkurzklemmhalter

Ø 87 - 1.000 mm

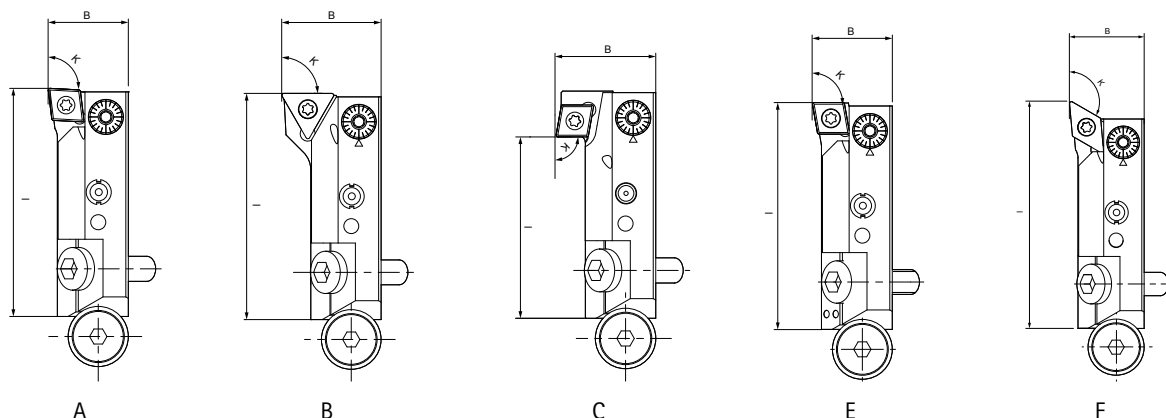

Typ	l	B	K	Ausführung	WSP	Spezifikation	Bestell-Nr.
A	45,5	16	93°	rechts	CC..0602	MBO501-R-093-16-CC_0602	10030384
A	45,5	16	93°	links	CC..0602	MBO501-L-093-16-CC_0602	30415298
B	45,5	20	90°	rechts	TC..1102	MBO501-R-090-20-TC_1102	30355664
B	45,5	20	90°	links	TC..1102	MBO501-L-090-20-TC_1102	30353989
C	36	20	90°	rückwärts	CC..0602	MBO501-B-090-20-CC_0602	30415297
A	45,5	16	95°	rechts	CC..0602	MBO501-R-095-16-CC_0602	10078197
A	45,5	16	95°	links	CC..0602	MBO501-L-095-16-CC_0602	30415299
E	45,5	16	90°	rechts	CC..0602	MBO501-R-090-16-CC_0602	10078198
E	45,5	16	90°	links	CC..0602	MBO501-L-090-16-CC_0602	10078199

Mit 10 µm-Feinjustierung | Verstellweg bezogen auf Maß B + 0,6 mm Ø
Lieferzeit auf Anfrage.

Auf Anfrage erhältlich

Typ	l	B	k	Ausführung	WSP	Spezifikation	Bestell-Nr.
F	48,5	16	120° (5°)	links	DC..0702	MBO501-L-120-16-DC_0702	30415305
F	45,8	16	120° (5°)	rechts	DC..0702	MBO501-R-120-16-DC_0702	30415302
A	45,5	22	95°	links	CC..09T3	MBO501-L-095-22-CC_09T3	30415304
A	45,5	22	95°	rechts	CC..09T3	MBO501-R-095-22-CC_09T3	30415301

ModulBore-Plus – Feinbohrkopf-Kurzklemmhalter

Typ	l	B	K	Ausführung	WSP	Spezifikation	Bestell-Nr.
A	45,5	16	93°	rechts	CC..0602	MBO511-R-093-16-CC_0602	30415307
A	45,5	16	95°	rechts	CC..0602	MBO511-R-095-16-CC_0602	30415308
A	45,5	16	90°	rechts	CC..0602	MBO511-R-090-16-CC_0602	30415306

Mit 2 µm-Feinjustierung | Verstellweg bezogen auf Maß B + 0,5 mm Ø
Lieferzeit auf Anfrage.

MBS-Adapter

Schaft SK nach ISO 7388-1 Form AD/AF

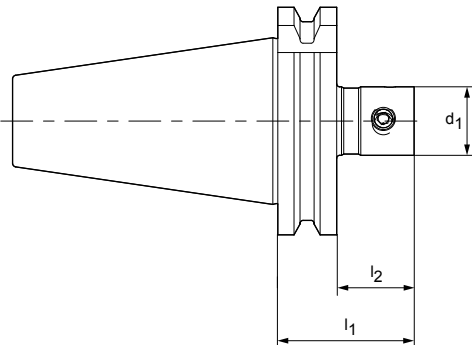

SK	d_1 MBS-Größe	l_1	l_2	Spezifikation	Bestell-Nr.
40	18,5	60	40	MBS101-N-185-040-SK040-S	30415332
40	24,5	60	40	MBS101-N-245-060-SK040-S	30415333
40	32	60	40	MBS101-N-320-060-SK040-S	30415334
40	42	60	40	MBS101-N-420-060-SK040-S	30415335
40	55	65	45	MBS101-N-550-065-SK040-S	30415336
50	18,5	40	20	MBS101-N-185-040-SK050-S	30415337
50	24,5	40	20	MBS101-N-245-040-SK050-S	30415338
50	32	60	40	MBS101-N-320-060-SK050-S	30415339
50	42	60	40	MBS101-N-420-060-SK050-S	30415340
50	55	60	40	MBS101-N-550-060-SK050-S	30415341
50	72	65	45	MBS101-N-720-065-SK050-S	30415342

Lieferzeit auf Anfrage.

MBS-Adapter

Schaft BT nach ISO 7388-2 Form J (JIS B 6339)

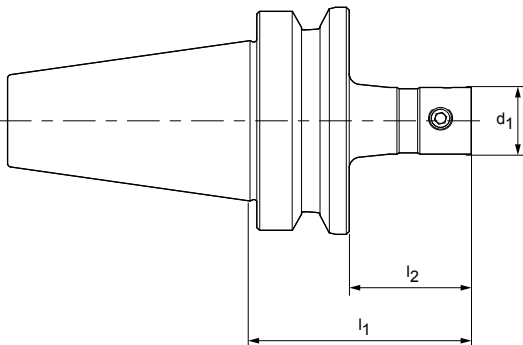

BT	d_1 MBS-Größe	l_1	l_2	Spezifikation	Bestell-Nr.
40	18,5	40	33	MBS101-N-185-060-BT040-S	30415344
40	24,5	40	33	MBS101-N-245-060-BT040-S	30415345
40	32	60	33	MBS101-N-320-060-BT040-S	30415346
40	42	60	33	MBS101-N-420-060-BT040-S	30415347
40	55	60	33	MBS101-N-550-065-BT040-S	30415348
50	18,5	40	-	MBS101-N-185-040-BT050-S	30415349
50	24,5	40	-	MBS101-N-245-040-BT050-S	30415350
50	32	60	22	MBS101-N-320-060-BT050-S	30415351
50	42	60	22	MBS101-N-420-060-BT050-S	30415352
50	55	60	27	MBS101-N-550-065-BT050-S	30415353
50	72	60	32	MBS101-N-720-070-BT050-S	30415354

Lieferzeit auf Anfrage.

MBS-Adapter

Schaft HSK-A nach DIN 69893-1

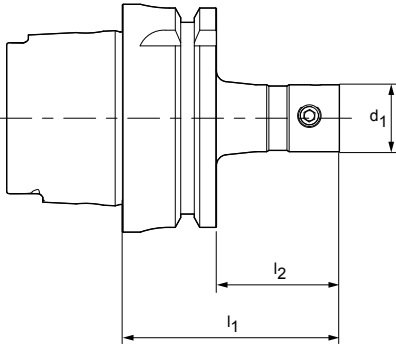

HSK-A	d_1 MBS-Größe	l_1	l_2	Spezifikation	Bestell-Nr.
63	18,5	60	34	MBS101-N-185-060-HSK-A063-S	30415367
63	24,5	60	34	MBS101-N-245-060-HSK-A063-S	30415368
63	32	60	34	MBS101-N-320-060-HSK-A063-S	30415369
63	42	70	44	MBS101-N-420-070-HSK-A063-S	30415370
63	55	80	54	MBS101-N-550-080-HSK-A063-S	30415371
63	72	95	69	MBS101-N-720-095-HSK-A063-S	30415372
100	32	70	41	MBS101-N-320-070-HSK-A100-S	30415373
100	42	80	51	MBS101-N-420-080-HSK-A100-S	30415374
100	55	90	61	MBS101-N-420-550-HSK-A100-S	30415375
100	72	105	76	MBS101-N-720-105-HSK-A100-S	30415376

Lieferzeit auf Anfrage.

MBS-Verlängerungen

MBS auf MBS

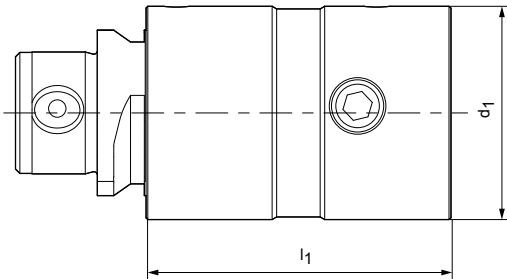

d ₁ MBS-Größe	l ₁	Spezifikation	Bestell-Nr.
18,5	30	MBS185-MBS185-030-01	30415380
18,5	35	MBS185-MBS185-035-01	30415381
24,5	30	MBS245-MBS245-030-01	30415382
24,5	35	MBS245-MBS245-035-01	30415383
24,5	45	MBS245-MBS245-045-01	30415384
32	40	MBS320-MBS320-040-01	30415385
32	50	MBS320-MBS320-050-01	30415386
32	60	MBS320-MBS320-060-01	30415387
42	50	MBS420-MBS420-050-01	30415388
42	60	MBS420-MBS420-060-01	30415389
42	80	MBS420-MBS420-080-01	30415390
55	70	MBS550-MBS550-070-01	30415391
55	90	MBS550-MBS550-090-01	30415392
55	105	MBS550-MBS550-105-01	30415393
72	75	MBS720-MBS720-075-01	30415394
72	100	MBS720-MBS720-100-01	30415395
72	135	MBS720-MBS720-135-01	30415396

Lieferzeit auf Anfrage.

MBS-Reduzierungen

MBS auf MBS

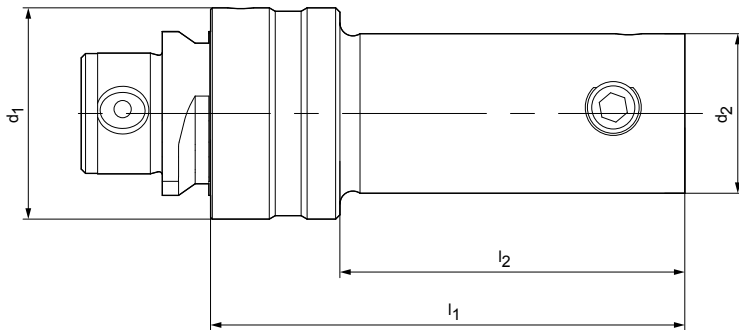

d ₁ MBS-Größe	d ₂ MBS-Größe	l ₁	l ₂	Spezifikation	Bestell-Nr.
24,5	18,5	30	15	MBS245-MBS185-030-01	30415399
32	18,5	30	51	MBS320-MBS185-030-01	30415401
32	24,5	40	25	MBS320-MBS245-040-01	30415403
42	18,5	35	15	MBS420-MBS185-035-01	30415405
42	24,5	45	25	MBS420-MBS245-045-01	30415407
42	32	45	25	MBS420-MBS320-045-01	30415409
55	18,5	40	15	MBS550-MBS185-040-01	30415411
55	24,5	50	25	MBS550-MBS245-050-01	30415413
55	32	50	25	MBS550-MBS320-050-01	30415415
55	42	55	30	MBS550-MBS420-055-01	30415417
72	42	60	30	MBS720-MBS420-060-01	30415419
72	55	60	30	MBS720-MBS550-060-01	30415420

Lieferzeit auf Anfrage.

ModulBore - Aufsteckdorne

Mit Quernut und MBS
Schaft MBS

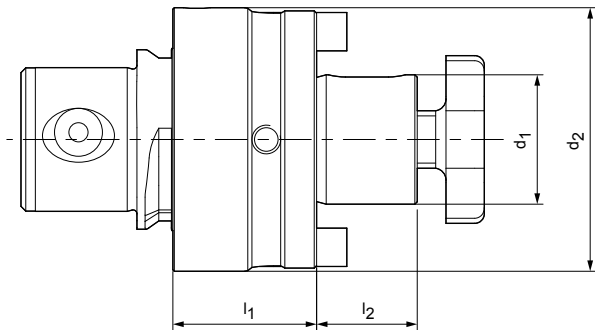

MBS-Größe	d_1	d_2	l_1	l_2	Spezifikation	Bestell-Nr.
MBS420	27	42	30	21	MCA-MBS420-27-30-1-0-W	30415312
MBS550	27	55	30	21	MCA-MBS550-27-30-1-0-W	30415313
MBS720	40	72	35	27	MCA-MBS720-40-35-1-0-W	30415314

Lieferzeit auf Anfrage.



KURZKLEMMHALTER

Neben der Justiermöglichkeit mit einem großen Einstellweg bieten Kurzklemmhalter durch ihre schnelle und einfache Austauschbarkeit zahlreiche Möglichkeiten für verschiedene Anwendungen. Dabei werden Kurzklemmhalter sowohl für außen- als auch für innenliegende Bearbeitungen genutzt. Bei Änderungen, zum Beispiel von Fasenwinkeln, oder im Reparaturfall sind Kurzklemmhalter ohne großen Aufwand austauschbar.

Das Angebot an MAPAL Kurzklemmhaltern deckt einen Großteil der konstruktiven Einbauvarianten ab. Neben den standardisierten ISO-Kurzklemmhaltern steht eine Reihe von Kompaktklemmhaltern für Radial- und Tangential-Wendeschneidplatten zur Verfügung. Diese bieten durch kürzere Baulängen noch mehr konstruktiven Freiraum bei der Auslegung von Sonderwerkzeugen.

Auf Anfrage liefert MAPAL auch Kurzklemmhalter und Kompaktklemmhalter in Sonderanfertigung.

Kurzklemmhalter

Bezeichnungsschlüssel	644
ISO-Kurzklemmhalter	646
Kompaktklemmhalter	650
Kompaktklemmhalter für Tangential-Wendeschneidplatten	656
Zubehör	660

Größenvergleich MAPAL Kompaktklemmhalter mit ISO-Kurzklemmhalter

Beispiel: WSP-Größe 09

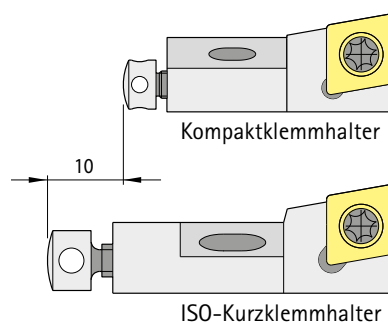

Bezeichnungsschlüssel Kurzklemmhalter und Kompaktklemmhalter

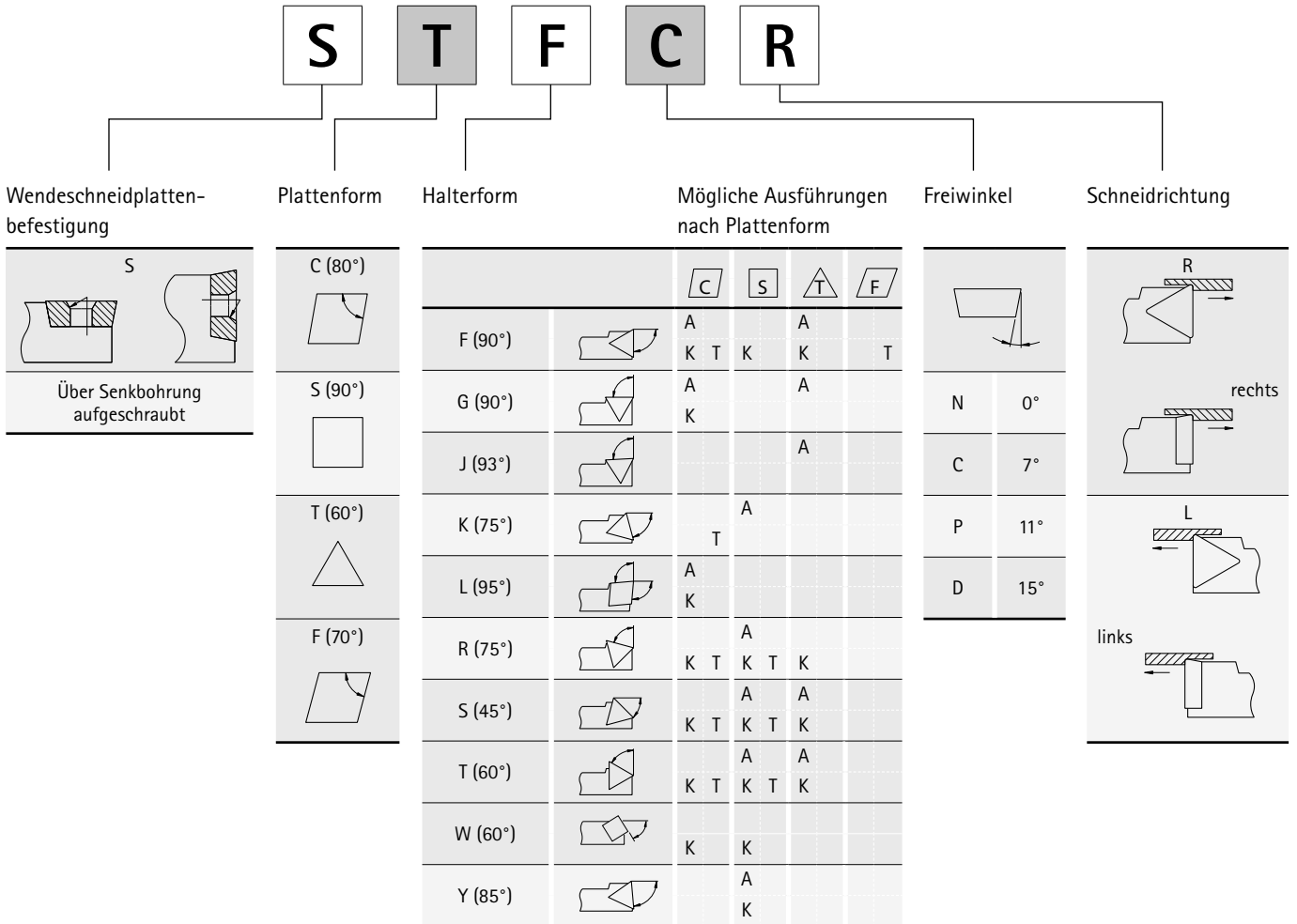

A = Kurzklemmhalter
K = Kompaktklemmhalter
T = Kompaktklemmhalter für Tangential-Wendeschneidplatten



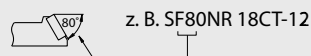
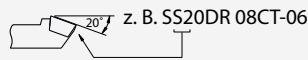

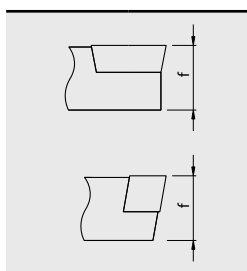
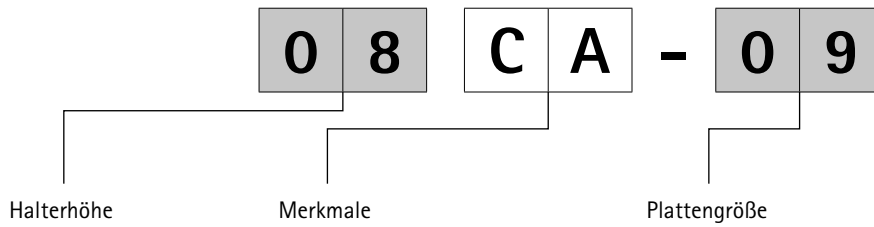
Kompaktklemmhalter mit Sonderwinkel
Angabe der Halterform direkt über den Einstellwinkel





Höhenangaben	
Kennzahl	[mm]
06	6,0
08	8,0
10	10,0
12	12,0
14	14,0
18	18,0

1. Stelle	Bedeutung
C	Kurzklemmhalter (Cartridge)
2. Stelle	Bedeutung
A	Kurzklemmhalter nach DIN 4985
K	Kompaktklemmhalter ähnlich DIN 4985
T	Kompaktklemmhalter ähnlich DIN 4985 für Tangential-Wendeschneidplatten

Inkreis				
d [mm]	C	S	T	F
5,56	05	-	09	-
6,35	06	06	11	06
9,525	09	09	16	09
12,7	12	12	-	12

ISO-Kurzklemmhalter

Form F, G

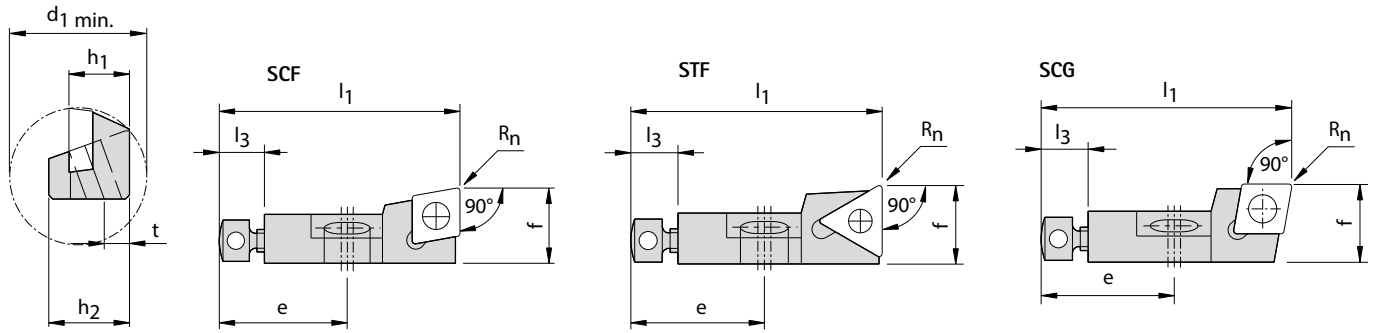

Zeichnungen in rechter Ausführung Beispiel SCFCR.

Lagerhaltige Vorzugsbaureihe

	Spezifikation	Zugehörige Schneidplatte	Baumaße									Zubehörgruppe *	Bestell-Nr.
			h_1	f (bezogen auf R_n)	R_n	l_1	e	l_3	h_2	t	$d_1 \text{ min.}$		
SCF...	SCFCR 08CA-06	CC_0602_	8	10	0,4	32	17	6	9,5	4,5	25	3	30011050
	SCFCL 08CA-06	CC_0602_	8	10	0,4	32	17	6	9,5	4,5	25	3	30011051
	SCFPR 08CA-06	CP_0602_	8	10	0,4	32	17	6	9,5	4,5	25	3	30011052
	SCFPL 08CA-06	CP_0602_	8	10	0,4	32	17	6	9,5	4,5	25	3	30011053
	SCFCR 10CA-09	CC_09T3_	10	14	0,8	50	20	8	13	5	40	5	30011054
	SCFCR 12CA-12	CC_1204_	12	20	0,8	55	20	8	17	6	50	1	30011056
	SCFCL 12CA-12	CC_1204_	12	20	0,8	55	20	8	17	6	50	1	30011057
STF...	STFCR 08CA-09	TC_0902_	8	10	0,4	32	17	6	9,5	4,5	25	2	30011058
	STFCR 10CA-11-02	TC_1102_	10	14	0,4	50	20	8	13	5	40	4	30011060
	STFCR 12CA-16	TC_16T3_	12	20	0,8	55	20	8	17	6	50	6	30011062
SCG...	SCGCR 08CA-06	CC_0602_	8	10	0,4	32	17	6	9,5	4,5	25	3	30011064
	SCGCL 08CA-06	CC_0602_	8	10	0,4	32	17	6	9,5	4,5	25	3	30011065
	SCGCR 10CA-09	CC_09T3_	10	14	0,8	50	20	8	13	5	40	5	30011068

* siehe Seiten 660-661

Weitere Schneidformen, Größen und Anstellwinkel auf Anfrage.
 Lieferumfang: Klemmhalter mit Einbauteilen. WSP und Zubehörteile bitte separat bestellen.
 Maßangaben in mm.

ISO-Kurzklemmhalter

Form J, K, L

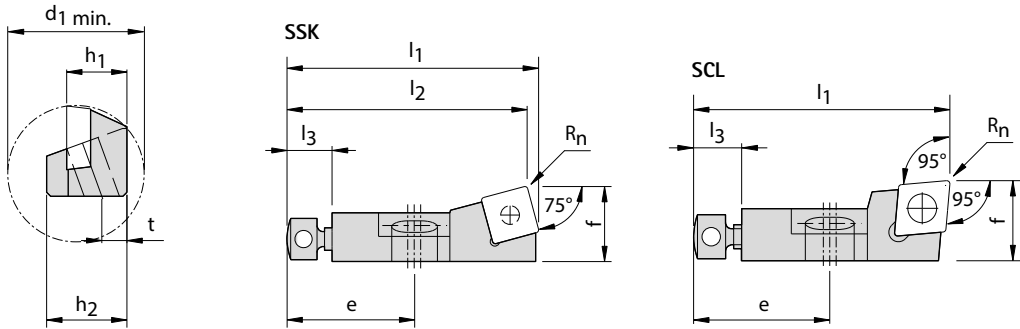

Zeichnungen in rechter Ausführung Beispiel STJCR.

Lagerhaltige Vorzugsbaureihe

	Spezifikation	Zugehörige Schneidplatte	Baumaße										Zubehörgruppe *	Bestell-Nr.
			h_1	f (bezogen auf R_n)	R_n	l_1	l_2	e	l_3	h_2	t	$d_1 \text{ min.}$		
SSK...	SSKCR 10CA-09	SC_09T3__	10	14	0,8	52,2	50	20	8	13	5	40	5	30011086
	SSKCL 10CA-09	SC_09T3__	10	14	0,8	52,2	50	20	8	13	5	40	5	30011087
	SSKCR 12CA-12	SC_1204__	12	20	0,8	58,1	55	20	8	17	6	50	1	30011088
SCL...	SCLCR 10CA-09	CC_09T3__	10	14	0,8	50	-	20	8	13	5	40	5	30011094
	SCLCL 10CA-09	CC_09T3__	10	14	0,8	50	-	20	8	13	5	40	5	30011095
	SCLCL 12CA-12	CC_1204__	12	20	0,8	55	-	20	8	17	6	50	1	30011097

* siehe Seiten 660-661

Weitere Schneidformen, Größen und Anstellwinkel auf Anfrage.
 Lieferumfang: Klemmhalter mit Einbauteilen. WSP und Zubehörteile bitte separat bestellen.
 Maßangaben in mm.

ISO-Kurzklemmhalter

Form R, S

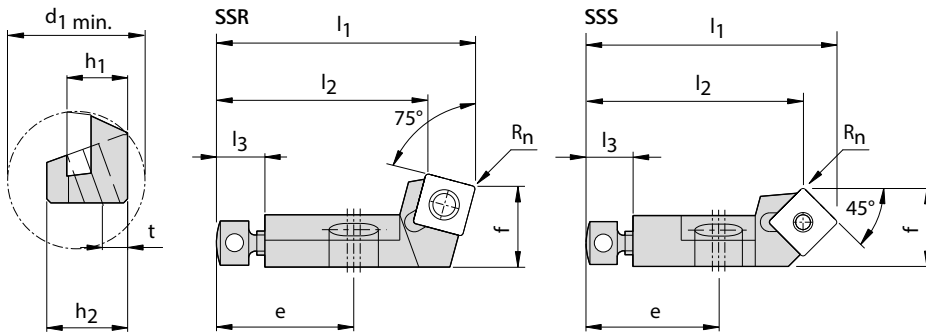

Zeichnungen in rechter Ausführung Beispiel SSRCR.

Lagerhaltige Vorzugsbaureihe

Spezifikation	Zugehörige Schneidplatte	Baumaße											Zubehörgruppe *	Bestell-Nr.
		h_1	f (bezogen auf R_n)	R_n	l_1	l_2	e	l_3	h_2	t	$d_1 \text{ min.}$			
SSR...	SSRCR 08CA-06	SC_0602_	8	10	0,4	32	26,4	17	6	9,5	4,5	25	3	30011098
	SSRCR 10CA-09	SC_09T3_	10	14	0,8	50	41,3	20	8	13	5	40	5	30011100
	SSRCR 12CA-12	SC_1204_	12	20	0,8	55	43,5	20	8	17	6	50	1	30011102
	SSRCL 12CA-12	SC_1204_	12	20	0,8	55	43,5	20	8	17	6	50	1	30011103
SSS...	SSSCR 08CA-06	SC_0602_	8	10	0,4	32,4	28	17	6	9,5	4,5	25	3	30011104
	SSSCL 08CA-06	SC_0602_	8	10	0,4	32,4	28	17	6	9,5	4,5	25	3	30011105
	SSSCR 10CA-09	SC_09T3_	10	14	0,8	50,1	44	20	8	13	5	40	5	30011106

* siehe Seiten 660-661

Weitere Schneidenformen, Größen und Anstellwinkel auf Anfrage.
 Lieferumfang: Klemmhalter mit Einbauteilen. WSP und Zubehörteile bitte separat bestellen.
 Maßangaben in mm.

ISO-Kurzklemmhalter

Form T, Y

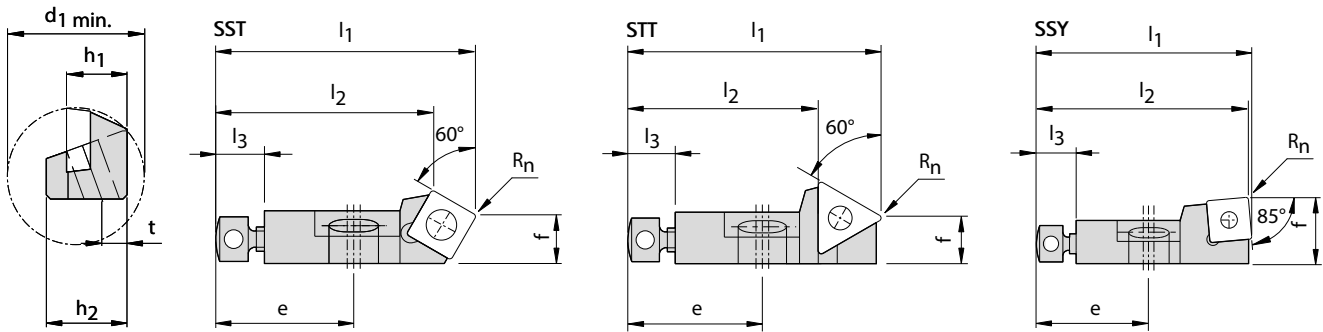

Zeichnungen in rechter Ausführung Beispiel SSTCR.

Lagerhaltige Vorzugsbaureihe

	Spezifikation	Zugehörige Schneidplatte	Baumaße										Zubehörgruppe *	Bestell-Nr.
			h_1	f (bezogen auf R_n)	R_n	l_1	l_2	e	l_3	h_2	t	$d_1 \text{ min.}$		
SST...	SSTCR 10CA-09	SC_09T3__	10	13,3	0,8	50	40,6	20	8	13	5	40	5	30011118
	SSTCL 10CA-09	SC_09T3__	10	13,3	0,8	50	40,6	20	8	13	5	40	5	30011119
	SSTCR 12CA-12	SC_1204__	12	18,9	0,8	55	44,8	20	8	17	6	50	1	30011120
STT...	STTCR 08CA-09	TC_0902__	8	10,3	0,4	32	24,6	17	6	9,5	4,5	25	2	30011122
	STTCR 10CA-11-02	TC_1102__	10	14	0,4	50	41,4	20	8	13	5	40	4	30011124
SSY...	SSYCR 10CA-09	SC_09T3__	10	14	0,8	50,8	50	20	8	13	5	40	5	30011130
	SSYCR 12CA-12	SC_1204__	12	20	0,8	56	55	20	8	17	6	50	1	30011132

* siehe Seiten 660-661

Weitere Schneidenformen, Größen und Anstellwinkel auf Anfrage.
Lieferumfang: Klemmhalter mit Einbauteilen. WSP und Zubehörteile bitte separat bestellen.
Maßangaben in mm.

Kompaktklemmhalter

Form F

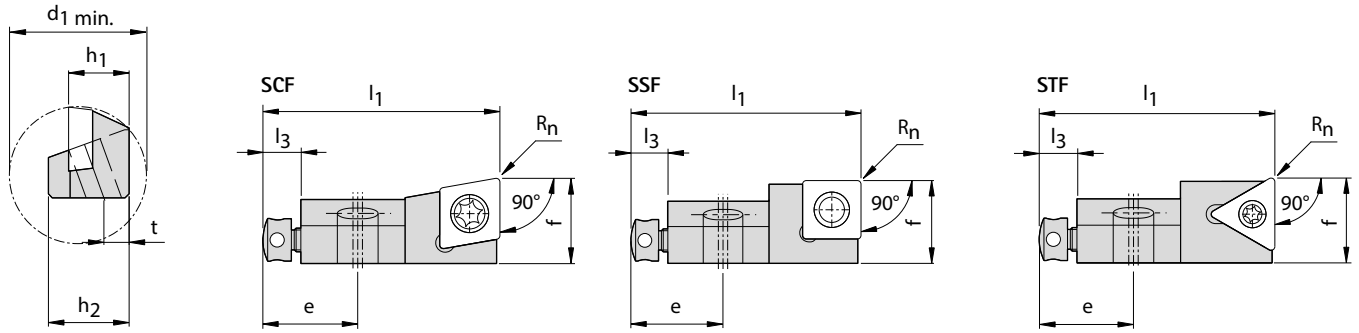

Zeichnungen in rechter Ausführung Beispiel SCFCR.

Lagerhaltige Vorzugsbaureihe

	Spezifikation	Zugehörige Schneidplatte	Baumaße									Zubehörgruppe *	Bestell-Nr.
			h_1	f (bezogen auf R_n)	R_n	l_1	e	l_3	h_2	t	$d_1 \text{ min.}$		
SCF...	SCFCR 06CK-06 V1	CC_0602_	6	8,5	0,4	25	11	5	6	2,5	18	9	30011134
	SCFCL 06CK-06 V1	CC_0602_	6	8,5	0,4	25	11	5	6	2,5	18	9	30011135
	SCFCR 06CK-06 V2	CC_0602_	6	9,7	0,4	25	11	5	6	2,5	18	9	30011136
	SCFCR 10CK-09	CC_09T3_	10	14	0,8	40	17	8	15	5	33	14	30011138
	SCFCL 10CK-09	CC_09T3_	10	14	0,8	40	17	8	15	5	33	14	30011139
	SCFCR 12CK-12	CC_1204_	12	18	0,8	50	20	8	16	5	37	7	30011140
	SCFCL 12CK-12	CC_1204_	12	18	0,8	50	20	8	16	5	37	7	30011141
SSF...	SSFPR 08CK-06	SP_0603_	8	10	0,4	32	17	5	10	4,5	24	13	30011142
	SSFPR 10CK-09	SC_09T3_	10	14	0,8	44	17	8	15	5	33	16	30011144
	SSFPR 12CK-12	SC_1204_	12	18	0,8	50	20	8	16	5	37	7	30011146
	SSFCL 12CK-12	SC_1204_	12	18	0,8	50	20	8	16	5	37	7	30011147
STF...	STFCR 06CK-09	TC_0902_	6	10	0,4	25	11	5	6	2,5	18	17	30011148
	STFCR 10CK-11	TC_1102_	10	14	0,4	40	17	8	15	5	33	11	30011150
	STFCR 12CK-16	TC_16T3_	12	18	0,8	50	20	8	16	5	37	12	30011152

* siehe Seiten 660-661

Weitere Schneidenformen, Größen und Anstellwinkel auf Anfrage.
 Lieferumfang: Klemmhalter mit Einbauteilen. WSP und Zubehörteile bitte separat bestellen.
 Maßangaben in mm.

Kompaktklemmhalter

Form G, L

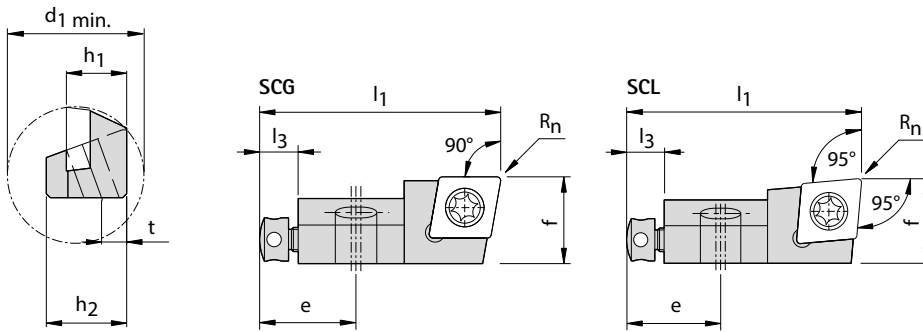

Zeichnungen in rechter Ausführung Beispiel SCGCR.

Lagerhaltige Vorzugsbaureihe

	Spezifikation	Zugehörige Schneidplatte	Baumaße									Zubehörgruppe *	Bestell-Nr.
			h_1	f (bezogen auf R_n)	R_n	l_1	e	l_3	h_2	t	d_1 min.		
SCG...	SCGCR 06CK-06 V1	CC_0602_	6	8,5	0,4	25	11	5	6	2,5	18	10	30011154
	SCGCL 06CK-06 V1	CC_0602_	6	8,5	0,4	25	11	5	6	2,5	18	10	30011155
	SCGCR 10CK-09	CC_09T3_	10	14	0,8	40	17	8	15	5	33	15	30011158
	SCGCL 10CK-09	CC_09T3_	10	14	0,8	40	17	8	15	5	33	15	30011159
	SCGCR 12CK-12	CC_1204_	12	18	0,8	50	20	8	16	5	37	8	30011160
	SCGCL 12CK-12	CC_1204_	12	18	0,8	50	20	8	16	5	37	8	30011161
SCL...	SCLCR 06CK-06 V1	CC_0602_	6	8,5	0,4	25	11	5	6	2,5	18	10	30011162
	SCLCL 06CK-06 V1	CC_0602_	6	8,5	0,4	25	11	5	6	2,5	18	10	30011163
	SCLCR 06CK-06 V2	CC_0602_	6	9,7	0,4	25	11	5	6	2,5	18	10	30011164
	SCLCL 06CK-06 V2	CC_0602_	6	9,7	0,4	25	11	5	6	2,5	18	10	30011165
	SCLCR 10CK-09	CC_09T3_	10	14	0,8	40	17	8	15	5	33	15	30011166
	SCLCL 10CK-09	CC_09T3_	10	14	0,8	40	17	8	15	5	33	15	30011167
	SCLCR 12CK-12	CC_1204_	12	18	0,8	50	20	8	16	5	37	7	30011168
	SCLCL 12CK-12	CC_1204_	12	18	0,8	50	20	8	16	5	37	7	30011169

* siehe Seiten 660-661

Weitere Schneidformen, Größen und Anstellwinkel auf Anfrage.
 Lieferumfang: Klemmhalter mit Einbauteilen. WSP und Zubehörteile bitte separat bestellen.
 Maßangaben in mm.

Kompaktklemmhalter

Form R

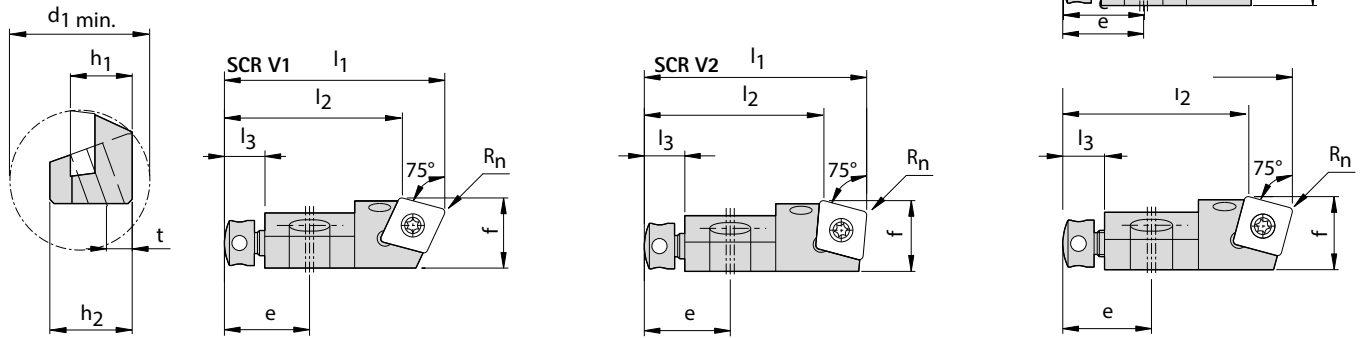

Zeichnungen in rechter Ausführung Beispiel SCRCR.

Lagerhaltige Vorzugsbaureihe

	Spezifikation	Zugehörige Schneidplatte	Baumaße										Zubehörgruppe *	Bestell-Nr.
			h_1	f (bezogen auf R_n)	R_n	l_1	l_2	e	l_3	h_2	t	$d_1 \text{ min.}$		
SCR...V1	SCRCR 06CK-06 V1	CC_0602__	6	9,7	0,4	25	19,2	11	5	6	2,5	18	9	30011170
	SCRCR 10CK-09 V1	CC_09T3__	10	14	0,8	44	35,5	17	8	15	5	33	14	30011172
SCR...V2	SCRCR 06CK-06 V2	CC_0602__	6	10	0,4	25	19,2	11	5	6	2,5	18	9	30011174
	SCRCR 10CK-09 V2	CC_09T3__	10	14	0,8	44	35,5	17	8	15	5	33	16	30011176
SSR...	SSRPR 08CK-06	SP_0603__	8	10	0,4	32	26,3	17	5	10	4,5	24	13	30011178
	SSRCR 10CK-09	SC_09T3__	10	14	0,8	44	35,7	17	8	15	5	33	16	30011180
	SSRCL 10CK-09	SC_09T3__	10	14	0,8	44	35,7	17	8	15	5	33	16	30011181
	SSRCR 12CK-12	SC_1204__	12	18	0,8	50	38,6	20	8	16	5	37	7	30011182
STR...	STRCR 10CK-11	TC_1102__	10	14	0,4	40	30,4	17	8	15	5	33	11	30011186
	STRCR 12CK-16	TC_16T3__	12	18	0,8	50	36,1	20	8	16	5	37	12	30011188

* siehe Seiten 660-661

Weitere Schneidenformen, Größen und Anstellwinkel auf Anfrage.
 Lieferumfang: Klemmhalter mit Einbauteilen. WSP und Zubehörteile bitte separat bestellen.
 Maßangaben in mm.

Kompaktklemmhalter

Form S

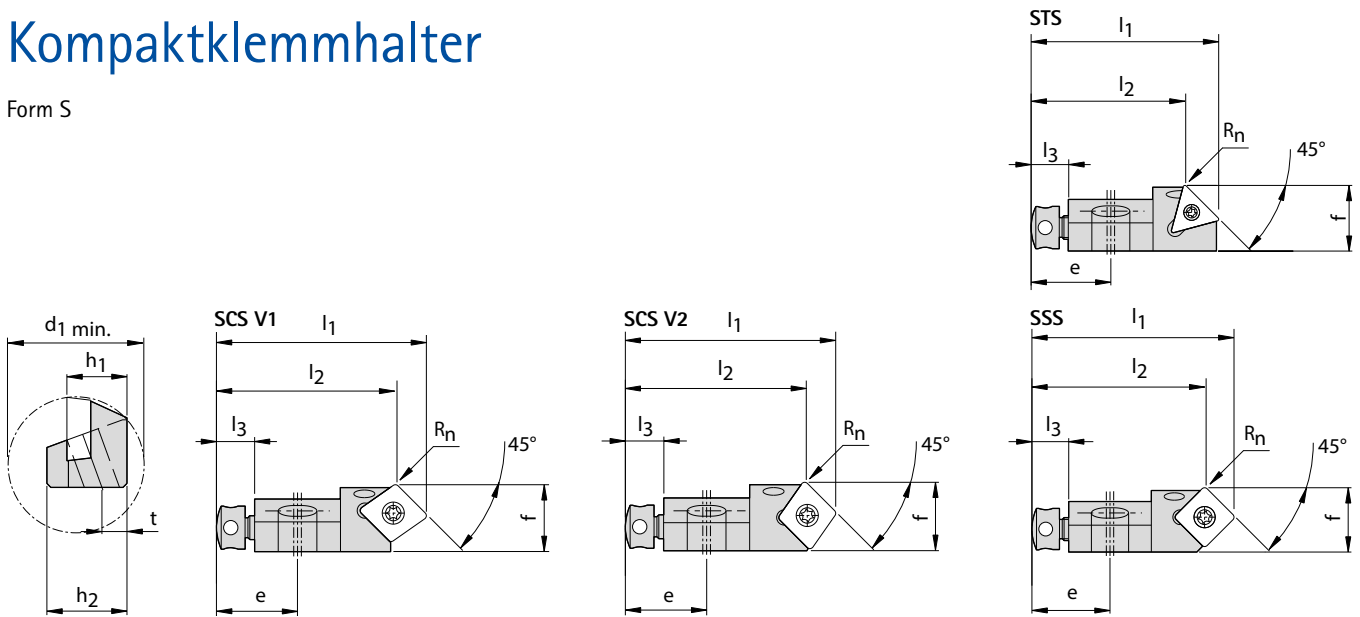

Zeichnungen in rechter Ausführung Beispiel SCSCR.

Lagerhaltige Vorzugsbaureihe

	Spezifikation	Zugehörige Schneidplatte	Baumaße										Zubehörgruppe *	Bestell-Nr.
			h_1	f (bezogen auf R_n)	R_n	l_1	l_2	e	l_3	h_2	t	$d_1 \text{ min.}$		
SCS...V1	SCSCR 06CK-06 V1	CC_0602__	6	9,7	0,4	25	20,8	11	5	6	2,5	18	9	30011190
	SCSCR 10CK-09 V1	CC_09T3__	10	14	0,8	44	37,8	17	8	15	5	33	14	30011192
SCS...V2	SCSCR 06CK-06 V2	CC_0602__	6	10	0,4	25	20,8	11	5	6	2,5	18	9	30011194
	SCSCR 10CK-09 V2	CC_09T3__	10	14,3	0,8	44	37,8	17	8	15	5	33	14	30011196
SSS...	SSSPR 08CK-06	SP_0603__	8	10	0,4	32	27,8	17	5	10	4,5	24	13	30011198
	SSSPL 08CK-06	SP_0603__	8	10	0,4	32	27,8	17	5	10	4,5	24	13	30011199
	SSSCR 10CK-09	SC_09T3__	10	14	0,8	44	37,9	17	8	15	5	33	14	30011200
	SSSCL 10CK-09	SC_09T3__	10	14	0,8	44	37,9	17	8	15	5	33	14	30011201
	SSSCR 12CK-12	SC_1204__	12	18	0,8	50	41,7	20	8	16	5	37	7	30011202
STS...	STSCR 06CK-09	TC_0902__	6	10	0,4	25	18,9	11	5	6	2,5	18	17	30011204
	STSCR 10CK-11	TC_1102__	10	14	0,4	40	33	17	8	15	5	33	11	30011206

* siehe Seiten 660-661

Weitere Schneidformen, Größen und Anstellwinkel auf Anfrage.
 Lieferumfang: Klemmhalter mit Einbauteilen. WSP und Zubehörteile bitte separat bestellen.
 Maßangaben in mm.

Kompaktklemmhalter

Form T

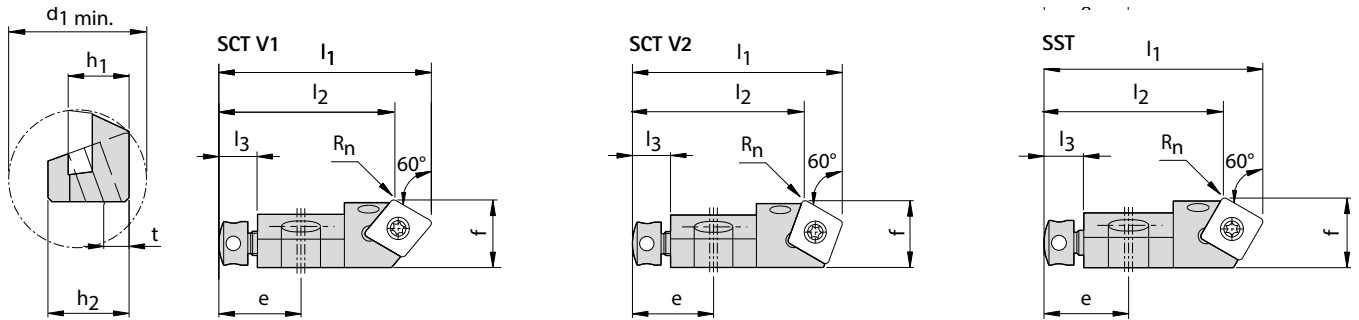

Zeichnungen in rechter Ausführung Beispiel SCTCR.

Lagerhaltige Vorzugsbaureihe

	Spezifikation	Zugehörige Schneidplatte	Baumaße										Zubehörgruppe *	Bestell-Nr.
			h_1	f	R_n	l_1	l_2	e	l_3	h_2	t	$d_1 \text{ min.}$		
SCT...V1	SCTCR 06CK-06 V1	CC_0602__	6	9,7	0,4	25	19,8	11	5	6	2,5	18	9	30011210
	SCTCR 10CK-09 V1	CC_09T3__	10	14	0,8	44	36,5	17	8	15	5	33	14	30011212
SCT...V2	SCTCR 06CK-06 V2	CC_0602__	6	10	0,4	25	19,8	11	5	6	2,5	18	9	30011214
	SCTCR 10CK-09 V2	CC_09T3__	10	14	0,8	44	36,5	17	8	15	5	33	16	30011216
SST...	SSTPR 08CK-06	SP_0603__	8	10	0,4	32	26,9	17	5	10	4,5	24	13	30011218
	SSTCR 10CK-09	SC_09T3__	10	14	0,8	44	36,6	17	8	15	5	33	14	30011220
	SSTCR 12CK-12	SC_1204__	12	18	0,8	50	39,8	20	8	16	5	37	7	30011222
ST...	STTCR 06CK-09	TC_0902__	6	10	0,4	25	17,6	11	5	6	2,5	18	17	30011224
	STTCR 10CK-11	TC_1102__	10	14	0,4	40	31,4	17	8	15	5	33	11	30011226
	STTCR 12CK-16	TC_16T3__	12	18	0,8	50	37,5	20	8	16	5	37	12	30011228

* siehe Seiten 660-661

Weitere Schneidenformen, Größen und Anstellwinkel auf Anfrage.
 Lieferumfang: Klemmhalter mit Einbauteilen. WSP und Zubehörteile bitte separat bestellen.
 Maßangaben in mm.

Kompaktklemmhalter

Form W, Y

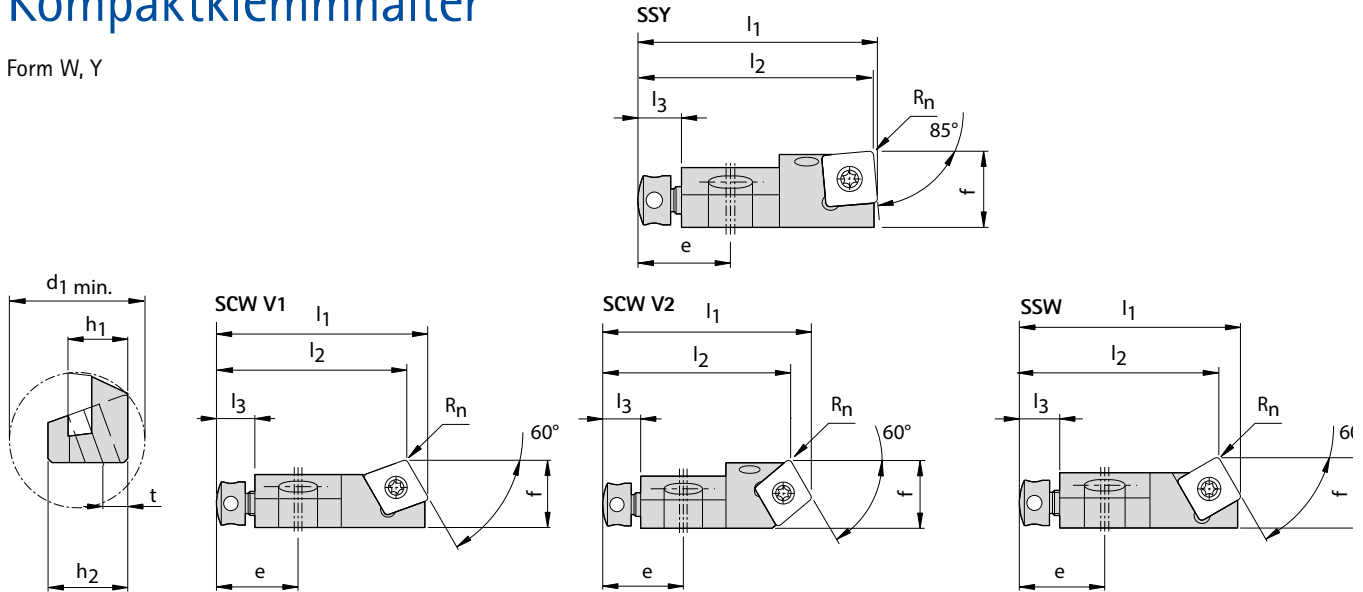

Zeichnungen in rechter Ausführung Beispiel SCWCR.

Lagerhaltige Vorzugsbaureihe

	Spezifikation	Zugehörige Schneidplatte	Baumaße										Zubehörgruppe *	Bestell-Nr.
			h_1	f (bezogen auf R_n)	R_n	l_1	l_2	e	l_3	h_2	t	$d_1 \text{ min.}$		
SCW...V1	SCWCR 06CK-06 V1	CC__0602__	6	9,7	0,4	25	22	11	5	6	2,5	18	9	30011230
	SCWCR 10CK-09 V1	CC__09T3__	10	14	0,8	44	39,6	17	8	15	5	33	16	30011232
SCW...V2	SCWCL 06CK-06 V2	CC__0602__	6	10	0,4	25	22	11	5	6	2,5	18	9	30011235
SSW...:	SSWPR 08CK-06	SP__0603__	8	10	0,4	32	29,1	17	5	10	4,5	24	13	30011238
	SSWCL 10CK-09	SC__09T3__	10	14	0,8	44	39,7	17	8	15	5	33	16	30011241
	SSWCR 12CK-12	SC__1204__	12	18	0,8	50	44,1	20	8	16	5	37	7	30011242
	SSWCL 12CK-12	SC__1204__	12	18	0,8	50	44,1	20	8	16	5	37	7	30011243
SSY...:	SSYPR 08CK-06	SP__0603__	8	10	0,4	32	31,5	17	5	10	4,5	24	13	30011250
	SSYCR 10CK-09	SC__09T3__	10	14	0,8	44	43,2	17	8	15	5	33	16	30011252
	SSYCL 10CK-09	SC__09T3__	10	14	0,8	44	43,2	17	8	15	5	33	16	30011253
	SSYCR 12CK-12	SC__1204__	12	18	0,8	50	49	20	8	16	5	37	7	30011254

* siehe Seiten 660-661

Weitere Schneidenformen, Größen und Anstellwinkel auf Anfrage.
 Lieferumfang: Klemmhalter mit Einbauteilen. WSP und Zubehörteile bitte separat bestellen.
 Maßangaben in mm.

Kompaktklemmhalter für Tangential-Wendeschnidplatten

Form F

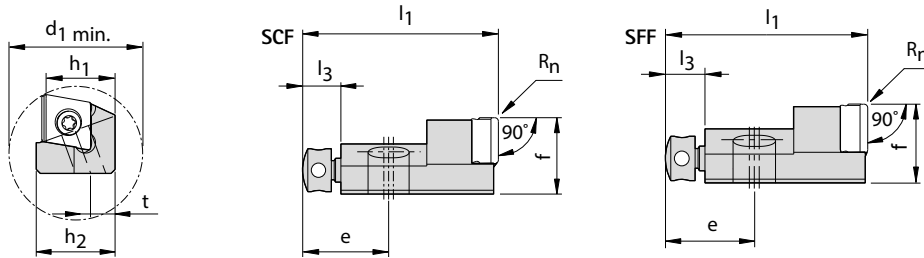

Zeichnungen in rechter Ausführung Beispiel SCFNR.

Lagerhaltige Vorzugsbaureihe

	Spezifikation	Zugehörige Schnidplatte	Baumaße										Zubehörgruppe *	Bestell-Nr.
			h_1	f (bezogen auf R_n)	R_n	l_1	l_2	e	l_3	h_2	t	$d_1 \text{ min.}$		
SCF...	SCFNR 10CT-06	CTHQ0604__	10	11	0,8	29	-	12	5	10,5	5	40	22	30305015
	SCFNR 14CT-09	CTHQ0905__	14	16	0,8	41	-	18	8	16	7	65	24	30305018
	SCFNR 18CT-12	CTHQ1206__	18	22	0,8	43	-	18	8	20	7	75	26	30305020
	SCFDR 10 CT-06	CTHD0603__	10	11	0,8	29	-	12	5	10,5	5	40	22	30552260
	SCFDR 14 CT-09	CTHD09T3__	14	16	0,8	41	-	18	8	16	7	65	20	30552263
	SCFDR 18 CT-12	CTHD1204__	18	22	0,8	43	-	18	8	20	7	75	18	30552264
SFF...	SFFNR 10CT-06	FTHQ0604__	10	11	0,8	29	-	12	5	10,5	5	35	22	30305022
	SFFNR 14CT-09	FTHQ0905__	14	16	0,8	41	-	18	8	16	7	44	24	30305024
	SFFNR 18CT-12	FTHQ1206__	18	22	0,8	43	-	18	8	20	7	59,5	26	30305026

* siehe Seiten 660-661

Kompaktklemmhalter für Tangential-Wendeschnidplatten

Form 80

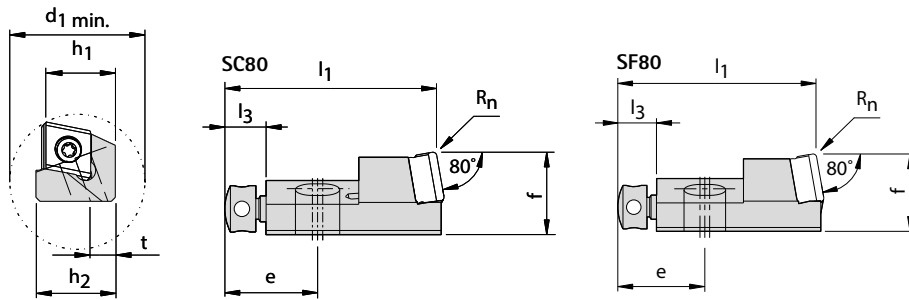

Zeichnungen in rechter Ausführung Beispiel SC80NR.

Lagerhaltige Vorzugsbaureihe

	Spezifikation	Zugehörige Schnidplatte	Baumaße										Zubehörgruppe *	Bestell-Nr.
			h_1	f (bezogen auf R_n)	R_n	l_1	l_2	e	l_3	h_2	t	$d_1 \text{ min.}$		
SC80...	SC80NR 10CT-06	CTHQ0604__	10	11	0,8	29	-	12	5	10,5	5	40	23	30305016
	SC80NR 14CT-09	CTHQ0905__	14	16	0,8	41	-	18	8	16	7	65	25	30305019
	SC80NR 18CT-12	CTHQ1206__	18	22	0,8	43	-	18	8	20	7	75	27	30305021
SF80...	SF80NR 10CT-06	FTHQ0604__	10	11	0,8	29	-	12	5	10,5	5	35	23	30305023
	SF80NR 14CT-09	FTHQ0905__	14	16	0,8	41	-	18	8	16	7	44	25	30305025
	SF80NR 18CT-12	FTHQ1206__	18	22	0,8	43	-	18	8	20	7	59,5	27	30305027

* siehe Seiten 660-661

Weitere Schnidformen, Größen und Anstellwinkel auf Anfrage.
 Lieferumfang: Klemmhalter mit Einbauteilen. WSP und Zubehörteile bitte separat bestellen.
 Maßangaben in mm.

Kompaktklemmhalter für Tangential-Wendeschnidplatten

Form S, T, R

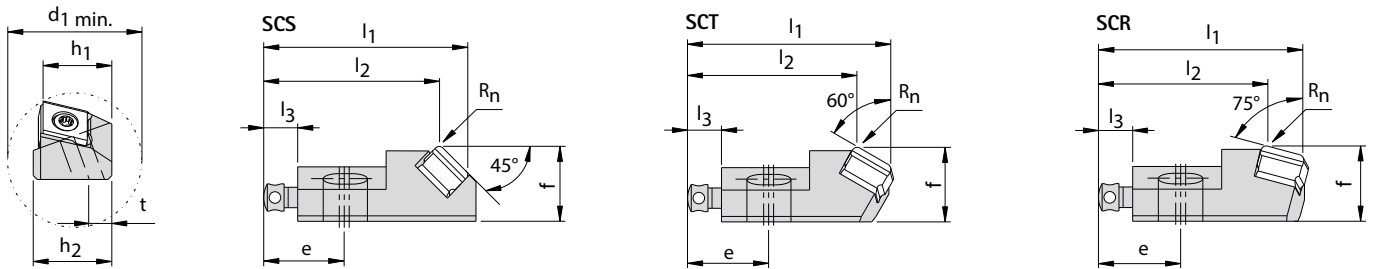

Zeichnungen in rechter Ausführung Beispiel SCSNR.

Lagerhaltige Vorzugsbaureihe

Spezifikation	Zugehörige Schneidplatte	Baumaße											Zubehörgruppe *	Bestell-Nr.
		h_1	f (bezogen auf R_n)	R_n	l_1	l_2	e	l_3	h_2	t	$d_1 \text{ min.}$			
SCS... SCSNR 14 CT-09	CTHQ0905__	14	16	0,8	42,5	36	18	8	16	7	65	30	30552283	
SCT... SCTNR 10 CT-06	CTHQ0604__	10	11	0,8	30	24,7	12	5	10,5	5	40	22	30552284	
	SCTNR 14 CT-09	14	16	0,8	42,5	34,4	18	8	16	7	65	20	30552285	
	SCTDR 10 CT-06	CTHD0603__	10	11	0,8	30	24,7	12	5	10,5	5	40	22	30552274
SCR... SCRNR 14 CT-09	CTHQ0905__	14	16	0,8	42,5	33,3	18	8	16	7	65	20	30552287	

* siehe Seiten 660-661

Kompaktklemmhalter für Tangential-Wendescheidplatten

Form S, T, 20, R

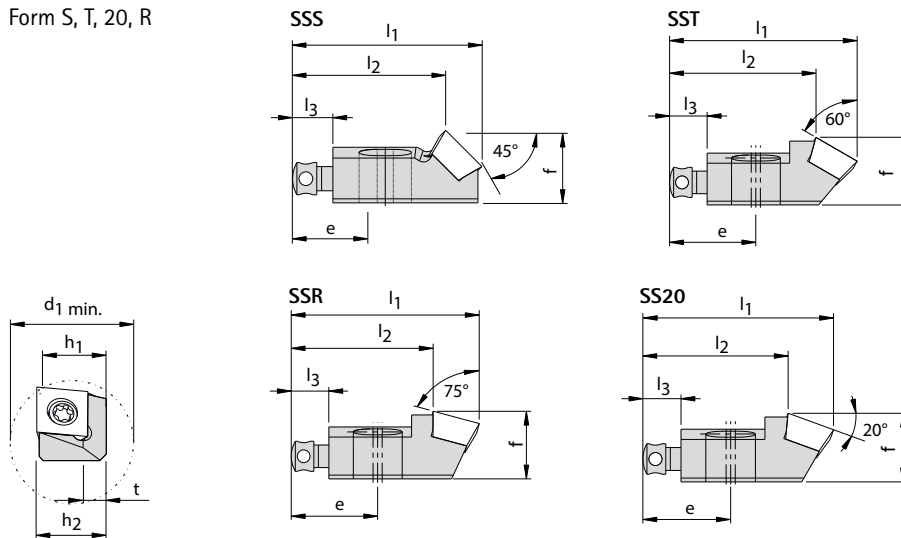

Zeichnungen in rechter Ausführung Beispiel SSSR.

Lagerhaltige Vorzugsbaureihe

	Spezifikation	Zugehörige Schneidplatte	Baumaße									Zubehörgruppe *	Bestell-Nr.
			h_1	f	l_1	l_2	e	l_3	h_2	t	$d_{1 \text{ min.}}$		
SSS...	SSSDR 08CT-06	STHD0603__	8,5	9	23,5	19	11,5	5	8,2	3,2	33	28	30474905
	SSSDR 14CT-09	STHD09T3__	14	13,5	35,7	29	18	8	13,5	5	50	32	30474906
SST...	SSTDR 08 CT-06	STHD0603__	8,5	9	25	19,5	11,5	5	8,2	3,2	33	28	30552292
	SSTDR 14 CT-09	STHD09T3__	14	13,5	38	29,8	18	8	13,5	5	50	32	30552293
SS20...	SS20DR 08 CT-06	STHD0603__	8,5	9	25	19	11,5	5	8,2	3,2	33	28	30552294
	SS20DR 14 CT-09	STHD09T3__	14	13,5	38	29	18	8	13,5	5	50	32	30552295
SSR...	SSRDR 08 CT-06	STHD0603__	8,2	9	25	18,9	11,5	5	8,2	3,2	33	28	30552288
	SSRDR 14 CT-09	STHD09T3__	14	13,5	38	28,8	18	8	13,5	5	50	32	30552289

* siehe Seiten 660-661

Weitere Schneidenformen, Größen und Anstellwinkel auf Anfrage.
 Lieferumfang: Klemmhalter mit Einbauteilen. WSP und Zubehörteile bitte separat bestellen.
 Maßangaben in mm.

Zubehör für ISO-Kurzklemmhalter und Kompaktklemmhalter

In radialer und tangentialer Bauweise

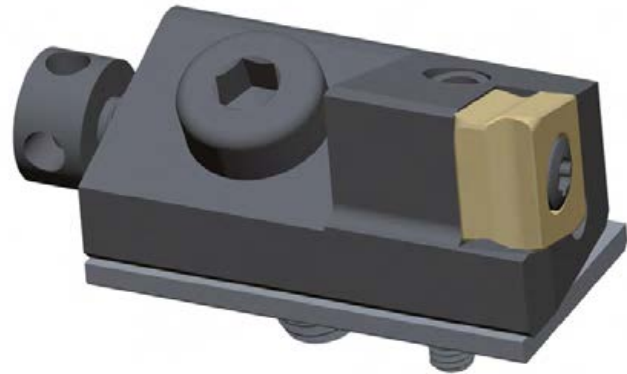

Zubehör- gruppe	Befestigungsschraube für Klemmhalter			Axial-Einstellschraube		Radial-Einstellschraube		
	Bestellbezeichnung Zylinderschraube	Anzugs- moment [Nm]*	Bestell-Nr.	Bestellbezeichnung Kreuzloch-Schraube	Bestell-Nr.	Bestellbezeichnung Gewindestift	Bestell-Nr.	
ISO-Kurzklemmhalter	1	DIN7984 M6x20-10.9	12	10019671	M5 x 10	10029150	DIN913 M4x10-45H	10003433
	2	DIN7984 M4x12-10.9	3	10019695	M3 x 8	10002641	DIN913 M3x6-45H	10003422
	3	DIN7984 M4x12-10.9	3	10019695	M3 x 8	10002641	DIN913 M3x6-45H	10003422
	4	DIN7984 M6x16-10.9	12	10019703	M5 x 10	10029150	DIN913 M4x8-45H	10003432
	5	DIN7984 M6x16-10.9	12	10019703	M5 x 10	10029150	DIN913 M4x8-45H	10003432
	6	DIN7984 M6x20-10.9	12	10019671	M5 x 10	10029150	DIN913 M4x10-45H	10003433
Kompaktklemmhalter	7	MN685 M6x25-TX25-IP	12	30606074	M5 x 7	10018493	DIN915 M4x10-45H	10003900
	8	MN685 M6x25-TX25-IP	12	30606074	M5 x 7	10018493	DIN915 M4x10-45H	10003900
	9	MN685 M3x10-TX9-IP	1,8	30606065	M3 x 5	10025039	DIN915 M3x6-45H	10003894
	10	MN685 M3x10-TX9-IP	1,8	30606065	M3 x 5	10025039	DIN915 M3x6-45H	10003894
	11	MN685 M6x20-TX25-IP	12	30606068	M5 x 7	10018493	DIN915 M4x10-45H	10003900
	12	MN685 M6x25-TX25-IP	12	30606074	M5 x 7	10018493	DIN915 M4x10-45H	10003900
	13	MN685 M4x14-TX15-IP	3	30606067	M3 x 5	10025039	DIN915 M3x6-45H	10003894
	14	MN685 M6x20-TX25-IP	12	30606068	M5 x 7	10018493	DIN915 M4x10-45H	10003900
	15	MN685 M6x20-TX25-IP	12	30606068	M5 x 7	10018493	DIN915 M4x10-45H	10003900
	16	MN685 M6x20-TX25-IP	12	30606068	M5 x 7	10018493	DIN915 M4x10-45H	10003900
17	MN685 M3x10-TX9-IP	1,8	30606065	M3 x 5	10025039	DIN915 M3x6-45H	10003894	
Tangentiale Kompaktklemmhalter	18	ISO 4762-M6X25-12.9	12	10003620	M5 x 7	10018493	ISO 4028-M4x10-45H-KL	30351530
	19	ISO 4762-M6X25-12.9	12	10003620	M5 x 7	10018493	ISO 4028-M4x10-45H-KL	30351530
	20	DIN 7984-M6X20-10.9	12	10019671	M5 x 7	10018493	ISO 4028-M4x10-45H-KL	30351530
	21	DIN 7984-M6X20-10.9	12	10019671	M5 x 7	10018493	ISO 4028-M4x10-45H-KL	30351530
	22	DIN 7984-M4X16-10.9	3	10019685	M3 x 5	10025039	ISO 4028-M3x6-45H-KL	30351529
	23	DIN 7984-M4X16-10.9	3	10019685	M3 x 5	10025039	ISO 4028-M3x6-45H-KL	30351529
	24	DIN 7984-M6X20-10.9	12	10019671	M5 x 7	10018493	ISO 4028-M4x10-45H-KL	30351530
	25	DIN 7984-M6X20-10.9	12	10019671	M5 x 7	10018493	ISO 4028-M4x10-45H-KL	30351530
	26	ISO 4762-M6X25-12.9	12	10003620	M5 x 7	10018493	ISO 4028-M4x10-45H-KL	30351530
	27	ISO 4762-M6X25-12.9	12	10003620	M5 x 7	10018493	ISO 4028-M4x10-45H-KL	30351530
	28	MN685 M4x14-TX15-IP	3	30606067	M3 x 5	10025039	-	-
	29	ISO 4762-M6X25-12.9	12	10003620	M5 x 7	10018493	-	-
	30	DIN 7984-M6X20-10.9	12	10019671	M5 x 7	10018493	ISO 4028-M4x10-45H-KL	30351530
	31	DIN 7984-M4X16-10.9	3	10019685	M3 x 5	10025039	ISO 4028-M3x6-45H-KL	30351529
	32	MN685 M6x20-TX25-IP	12	30606068	M5 x 7	10018493	-	-

* Anzugsmomente nach MN678



Unterlegplatte rechts		Unterlegplatte links		Befestigungsschraube für Unterlegplatte		
Bestellbezeichnung Unterlegplatte	Bestell-Nr.	Bestellbezeichnung Unterlegplatte	Bestell-Nr.	Bestellbezeichnung Senkschraube	* Anzugs-moment [Nm]	Bestell-Nr.
UR 12-1A	auf Anfrage	UL 12-1A	auf Anfrage	ISO 10642-M3X8-10.9	1,8	10003769
UR 08-1A	auf Anfrage	UL 08-1A	auf Anfrage	ISO 10642-M3X6-10.9	1,8	10003768
UR 08-1A	auf Anfrage	UL 08-1A	auf Anfrage	ISO 10642-M3X6-10.9	1,8	10003768
UR 10-1A	auf Anfrage	UL 10-1A	auf Anfrage	ISO 10642-M3X8-10.9	1,8	10003769
UR 10-1A	auf Anfrage	UL 10-1A	auf Anfrage	ISO 10642-M3X8-10.9	1,8	10003769
UR 12-1A	auf Anfrage	UL 12-1A	auf Anfrage	ISO 10642-M3X8-10.9	1,8	10003769
UR 12-1K	auf Anfrage	UL 12-1K	auf Anfrage	ISO 10642-M3X8-10.9	1,8	10003769
UR 12-2K	auf Anfrage	UL 12-2K	auf Anfrage	ISO 10642-M3X8-10.9	1,8	10003769
UR 06-1K	auf Anfrage	UL 06-1K	auf Anfrage	ISO 2009-M2X4-4.8	0,5	10029153
UR 06-2K	auf Anfrage	UL 06-2K	auf Anfrage	ISO 2009-M2X4-4.8	0,5	10029153
UR 10-1K	auf Anfrage	UL101K	auf Anfrage	ISO 10642-M3X8-10.9	1,8	10003769
UR 12-1K	auf Anfrage	UL 12-1K	auf Anfrage	ISO 10642-M3X8-10.9	1,8	10003769
UR 08-1K	auf Anfrage	UL 08-1K	auf Anfrage	ISO 10642-M3X6-10.9	1,8	10003768
UR 10-1K	auf Anfrage	UL 10-1K	auf Anfrage	ISO 10642-M3X8-10.9	1,8	10003769
UR 10-2K	auf Anfrage	UL 10-2K	auf Anfrage	ISO 10642-M3X8-10.9	1,8	10003769
UR 10-3K	auf Anfrage	UL 10-3K	auf Anfrage	ISO 10642-M3X8-10.9	1,8	10003769
UR 06-1K	auf Anfrage	UL 06-1K	auf Anfrage	ISO 2009-M2X4-4.8	0,5	10029153
UR 18-1T	auf Anfrage	-	-	ISO 10642-M3X8-10.9	1,8	10003769
UR 18-4T	auf Anfrage	-	-	ISO 10642-M3X8-10.9	1,8	10003769
UR 14-1T	auf Anfrage	-	-	ISO 10642-M3X8-10.9	1,8	10003769
UR 14-4T	auf Anfrage	-	-	ISO 10642-M3X8-10.9	1,8	10003769
UR 10-1T	auf Anfrage	-	-	ISO 10642-M3X8-10.9	1,8	10003769
UR 10-2T	auf Anfrage	-	-	ISO 10642-M3X8-10.9	1,8	10003769
UR 14-2T	auf Anfrage	-	-	ISO 10642-M3X8-10.9	1,8	10003769
UR 14-3T	auf Anfrage	-	-	ISO 10642-M3X8-10.9	1,8	10003769
UR 18-2T	auf Anfrage	-	-	ISO 10642-M3X8-10.9	1,8	10003769
UR 18-3T	auf Anfrage	-	-	ISO 10642-M3X8-10.9	1,8	10003769
-	-	-	-	-	-	-
-	-	-	-	-	-	-
UR 14-5T	auf Anfrage	-	-	ISO 10642-M3X8-10.9	1,8	10003769
UR 10-3T	auf Anfrage	-	-	ISO 10642-M3X8-10.9	1,8	10003769
-	-	-	-	-	-	-



WENDESCHNEID- PLATTEN

Einführung

Schneidstoffserien	664
Produktübersicht	666
Schneidstoffübersicht	670
Bezeichnungsschlüssel	676
Übersicht Spanleitstufen	680

Wendeschneidplatten

Radial-Wendeschneidplatten	686
Tangential-Wendeschneidplatten	708
Zubehör	730

Technischer Anhang

Schnittwertempfehlung	732
-----------------------------	-----

Schneidstoffserien – für jede Anwendung den richtigen Schneidstoff

MAPAL bietet ein breites Angebot an Radial- und Tangential-Wendeschneidplatten, das alle Anforderungen an verschiedene Schneidstoffe und Beschichtungen sowie die entsprechenden Schneidengeometrien und Genauigkeiten abdeckt.

Schneidstoffserie Performance Line



Die Schneidstoffserie der Performance Line umfasst ein breites Angebot an Radial- und Tangential-Wendeschneidplatten, das alle Anforderungen an verschiedene Schneidstoffe und Beschichtungen sowie die entsprechenden Schneidengeometrien und Genauigkeiten abdeckt.

Geschliffene, hochgenaue Wendeschneidplatten der Toleranzklasse H ermöglichen „echte Mehrschneidigkeit“ auch bei fest eingebauten Schneiden. Denn in Verbindung mit präzise gefertigten Plattensitzen weisen die Schneiden nur minimale Abweichungen zueinander auf. Das heißt, dass alle Schneiden bei der Bearbeitung gleichzeitig im Einsatz sind. Dadurch sind erhebliche Leistungssteigerungen möglich.

Gesinterte Tangential-Wendeschneidplatten in der Toleranzklasse N erweitern das Programm um besonders wirtschaftliche Alternativen, insbesondere für Bearbeitungen mit größeren zulässigen Toleranzen. Neu im Programm sind die umfangsgeschliffenen Radial- und Tangential-Wendeschneidplatten der Toleranzklasse G, die eine kostengünstige Alternative zu den hochgenauen Wendeschneidplatten darstellen.

AUF EINEN BLICK

- Breites Angebot an Radial- und Tangential-Wendeschneidplatten
- Das Angebot reicht von geschliffenen, hochgenauen Wendeschneidplatten in der Toleranzklasse H bis zu gesinterten Wendeschneidplatten in der Toleranzklasse N und G
- Große Auswahl an Schneidstoffen für nahezu jeden Einsatzbereich
- Bestückte Varianten mit PKD und PcBN für die hochwirtschaftliche Bearbeitung von Aluminium beziehungsweise Guss

Kennzeichnung gepresste Wendeschneidplatten "press-to-size"



Schneidstoffserie Basic Line

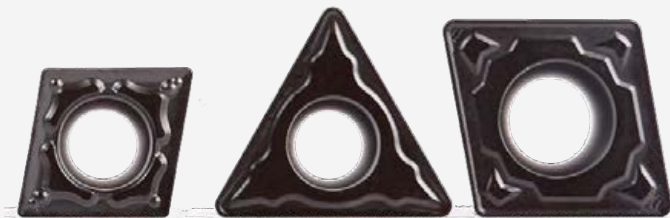

Das Basic-Line Programm an positiven Radialschneiden zum Aufbohren und Drehen überzeugt durch ein hervorragendes Preis-Leistungs-Verhältnis. Für die Bearbeitung von Gusseisen, Stahl und rostfreiem Stahl stehen CVD- und PVD-beschichtete Schneidstoffe bereit, die eine große Bandbreite zwischen Verschleißfestigkeit und Zähigkeit abdecken. So kann für jede Anwendung die optimale Wendeschneidplatte gewählt werden. Abhängig von der Bearbeitung stehen verschiedene Grundformen mit unterschiedlichen Spanleitstufen in den Toleranzklassen M und G zum Schruppen, für die mittlere Bearbeitung und zum Schlichten zur Verfügung.

AUF EINEN BLICK

- Positive Radialschneiden zum Aufbohren und Drehen
- Hervorragendes Preis-Leistungs-Verhältnis
- CVD- und PVD-beschichtete Schneidstoffe für P-, M- und K-Werkstoffe
- Cermet-Schneiden für hohe Oberflächengüte in Stahl
- Unterschiedliche Spanleitstufen zum Schruppen, für die mittlere Bearbeitung und zum Schlichten

Schneidstoffserie zur Mischbearbeitung



Werkstoffkombinationen aus Aluminium und Sinterstahl oder Aluminium und Guss, wie sie beispielsweise bei der Fertigung des Kurbelgehäuses eingesetzt werden, stellen besondere Anforderungen an die Zerspanung. Für derartige Bearbeitungen bietet MAPAL eine eigens darauf abgestimmte Schneidstoffserie. Sowohl deren Hartmetallsubstrate als auch die Mikro- und Makrogeometrien der Schneiden wurden speziell für die Mischbearbeitung entwickelt.









Eine PVD-Beschichtung als Teil der Schneidstoffserie verhindert sowohl eine Aufbauschneide während der Aluminiumbearbeitung als auch einen übermäßigen Verschleiß bei der Zerspannung des Gusseisen- beziehungsweise des Sinterstahlanteils am Werkstück. Denn sie sorgt dafür, dass der Schneidstoff besonders verschleiß- und hitzebeständig ist. Die Bearbeitung kann so in höchster Qualität erfolgen.

AUF EINEN BLICK

- Schneidstoff für die Bearbeitung der Materialkombinationen Aluminium-Guss und Aluminium-Sinterstahl
- Angepasste Hartmetallsubstrate, optimierte Mikro- und Makrogeometrien der Schneide, PVD-Beschichtung basierend auf einer TiAlN-Legierung mit speziellem Dotierelement
- Standard- und Sonder-ISO-Wendeschneidplatten verfügbar
- Lange Standzeit und damit hohe Wirtschaftlichkeit

Produktübersicht Wendeschneidplatten 1/2

Radialtechnologie

Plattentyp	Radialtechnologie – Basic Line							
	CCMT	CCGT	DCMT	SCMT SPMT	SCGT	TCMT	VCMT	VCGT
								

Merkmale

Anzahl Schneidkanten	2	2	2	4	4	3	2	2
Plattengröße	06 / 09 / 12	06 / 09 / 12	07 / 11 / 15	06 / 09 / 12	09	09 / 11 / 16 / 22	16	11
Durchmesserbereich	ab 17 mm	ab 17 mm		ab 17 mm	ab 25 mm	ab 17 mm		
Schneidrichtung	N	N	N	N	N	N	N	N
Aufbohren – Neutral	■	■	■	■	■	■	■	■
Aufbohren – Bogenschliff								
Senken / Anfasen								

Anwendung

Schruppen	■		■	■		■	■	
Mittlere Bearbeitung	■	■	■	■		■	■	■
Schlichten	■	■	■	■	■	■		

Schneidstoff

Hartmetall – geschliffen		■						■
Hartmetall – gepresst	■		■	■		■	■	
Cermet		■	■		■	■	■	
PcBN								
PKD								

Materialeignung

P	■	■	■	■	■	■	■	■
M ₁	■	■	■	■		■		■
M ₂	■	■	■	■		■		■
K	■		■	■		■	■	
N								
N K								
N P								

Seite	686	688	692	694	694	700	704	704
-------	-----	-----	-----	-----	-----	-----	-----	-----

* bei günstiger Einbausituation

Rostfreier Stahl

Hitzebeständiger Stahlguss (Turboladerwerkstoffe)



2	2	2	4	4	2	4	3	1
06/09	06/09/12	09	06/09/12	06/09/12	06/09/12	09	06/09/11/16	06/09/11/16
ab 17 mm	ab 17 mm	ab 24 mm	ab 17 mm	ab 17 mm	ab 17 mm	ab 25 mm	ab 15 mm	ab 15 mm
N	L/R	L/R	N	L/R	X	L/R	L/R	X
■	■	■	■	■	■	■	■	■

■	■		■	■	■	■	■	■
■	■		■	■	■	■	■	■







■	■	■	■	■	■	■	■	■

■	■		■	■	■		■	■
	■			■	■		■	■
		■				■		
		■				■		■

689	690	706	696	698	697	707	702	703
-----	-----	-----	-----	-----	-----	-----	-----	-----

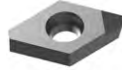
Produktübersicht Wendeschneidplatten 2/2

Tangentialtechnologie

Plattentyp	Radialtechnologie – Performance Line							
	CCGT	CCGW	DCGT	DCGW	SCGT SPGT	SCGW SPGW	TCGW	VBGW VCGW
								

Merkmale

Anzahl Schneidkanten	1	1	1	1	1	1	1	1
Plattengröße	06 / 09	06 / 09	11	11	06 / 09	06 / 09 / 12	11	16
Durchmesserbereich	ab 17 mm	ab 17 mm			ab 17 mm	ab 17 mm	ab 17 mm	
Schneidrichtung	N	N	N	N	L / R / N	N	N	N
Aufbohren-Neutral	■	■	■	■	■	■	■	■
Aufbohren-Bogenschliff								
Senken / Anfasen								

Anwendung

Schruppen								
Mittlere Bearbeitung	■	■	■			■	■	
Schlichten	■	■	■	■	■	■	■	■











Schneidstoff

Hartmetall - geschliffen								
Hartmetall - gepresst								
Cermet								
PcBN		■		■		■	■	■
PKD	■	■	■	■	■	■	■	

Materialeignung

P								
M ₁								
M ₂								
K		■		■		■	■	■
N	■	■	■	■	■	■	■	
N K								
N P								

Seite	688	689	692	692	694	696	700	704
-------	-----	-----	-----	-----	-----	-----	-----	-----

Tangentialtechnologie – Performance Line									
CTNQ	CTGQ	CTHQ		FTNQ	FTGQ	FTHQ		STHD / STHE	
									
4	4	4	1	4	4	4	1	4	1
09 / 12	09 / 12	06 / 09 / 12	06 / 09 / 12	09 / 12	09 / 12	06 / 09 / 12	06 / 09 / 12	06 / 09	06 / 09
ab 41 mm	ab 65 mm	ab 28 mm	ab 28 mm	ab 30 mm	ab 30 mm	ab 22 mm	ab 22 mm		
L / R	L	L / R	L / R	L / R	L	L / R	L / R	N	N
■		■	■	■		■	■		
	■	■	■		■	■	■		
								■	■
■	■	■	■	■	■	■	■		
■	■	■	■	■	■	■	■		
■		■			■	■		■	
	■			■					
			■				■		■
■	■	■		■	■	■			
■	■	■		■		■			
■	■	■		■		■		■	
■		■		■	■	■		■	
		■	■			■	■	■	■
708	710	712	712	718	720	722	722	728	728

Schneidstoffübersicht: Auswahl des richtigen Schneidstoffs

Auswahl eines Schneidstoffs

Die Schneidstoffe decken eine große Bandbreite zwischen Verschleißfestigkeit und Zähigkeit ab. Die Schneidstoffbezeichnung ist so aufgebaut, dass die Zähigkeit mit steigender Zahl zunimmt.

CVD-beschichtete Schneidstoffe (HC...) sind die erste Wahl beim Aufbohren von K-, P- und M-Werkstoffen. Sie erreichen höchste Standzeit.

Beispiel: HC830 ist zäher als HC815 (je zäher ein Schneidstoff, desto geringer die Verschleißfestigkeit).

Für NE-Werkstoffe sind unbeschichtete und PKD-beschichtete Hartmetallsorten (HU.../HP...) die erste Wahl. Ab einem Siliziumgehalt von $\geq 12\%$ wird aufgrund der zunehmenden Abrasivität PKD (PU...) empfohlen. Mit PKD sind höchste Standzeiten erreichbar, weshalb dieser Schneidstoff besonders für Großserien geeignet ist.

1. Wählen Sie Ihren Werkstoff gemäß der MZG (MAPAL Zerspanungsgruppen, siehe Klappseite am Umschlag).
2. Wählen Sie abhängig von der Produktlinie aus der entsprechenden **Tabelle „Schneidstoffübersicht [...]“** die Sorte, die sich unterhalb des gewünschten Werkstoffs befindet.
3. Abhängig von den Rahmenbedingungen (siehe **Tabelle "Rahmenbedingungen"**) ist ein verschleißfester oder eher zäher CVD-beschichteter Schneidstoff zu wählen.
4. Überwiegen die Rahmenbedingungen in Richtung der schwarzen Pfeile und können Brüche trotz zäher CVD-Sorte nicht verhindert werden, sollte auf PVD-beschichtete Schneidstoffe umgestellt werden.

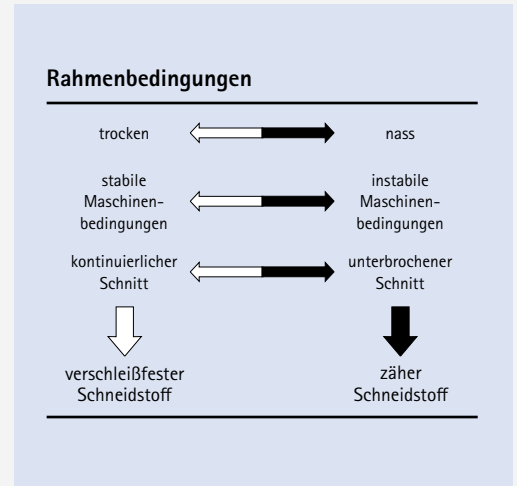

Schneidstoffübersicht Basic Line

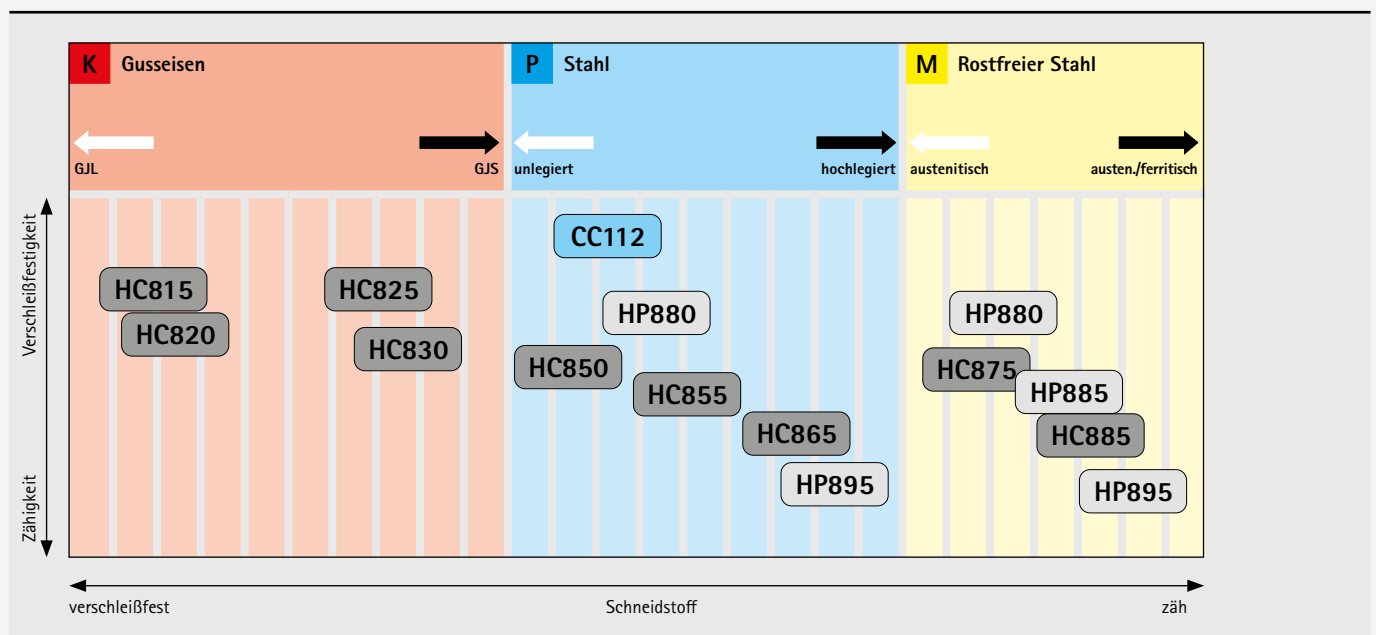

Auswahl eines Schneidstoffs

1. Wählen Sie aus der **Tabelle „Schneidstoffübersicht“** die Sorte, die sich unterhalb des gewünschten Werkstoffs befindet.
2. Bei der Mischbearbeitung von Aluminium-Gusseisen ist die Sorte HP530-P die erste Wahl, bei Aluminium-Stahl die Sorte HP545-P.
3. Ist ein stabiler Prozess mit normalem Verschleiß sichergestellt, kann für eine höhere Standzeit eine verschleißfestere Sorte – HP525-P für Aluminium-Gusseisen bzw. HP540-P für Aluminium-Stahl – gewählt werden.

Schneidstoffübersicht Mischbearbeitung

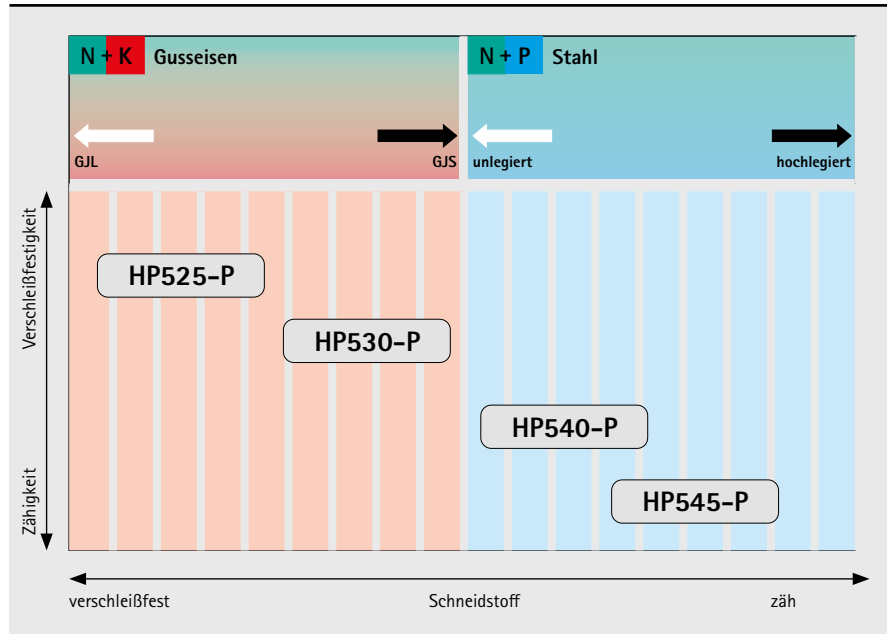

PVD-polirt

Schneidstoffübersicht Performance Line

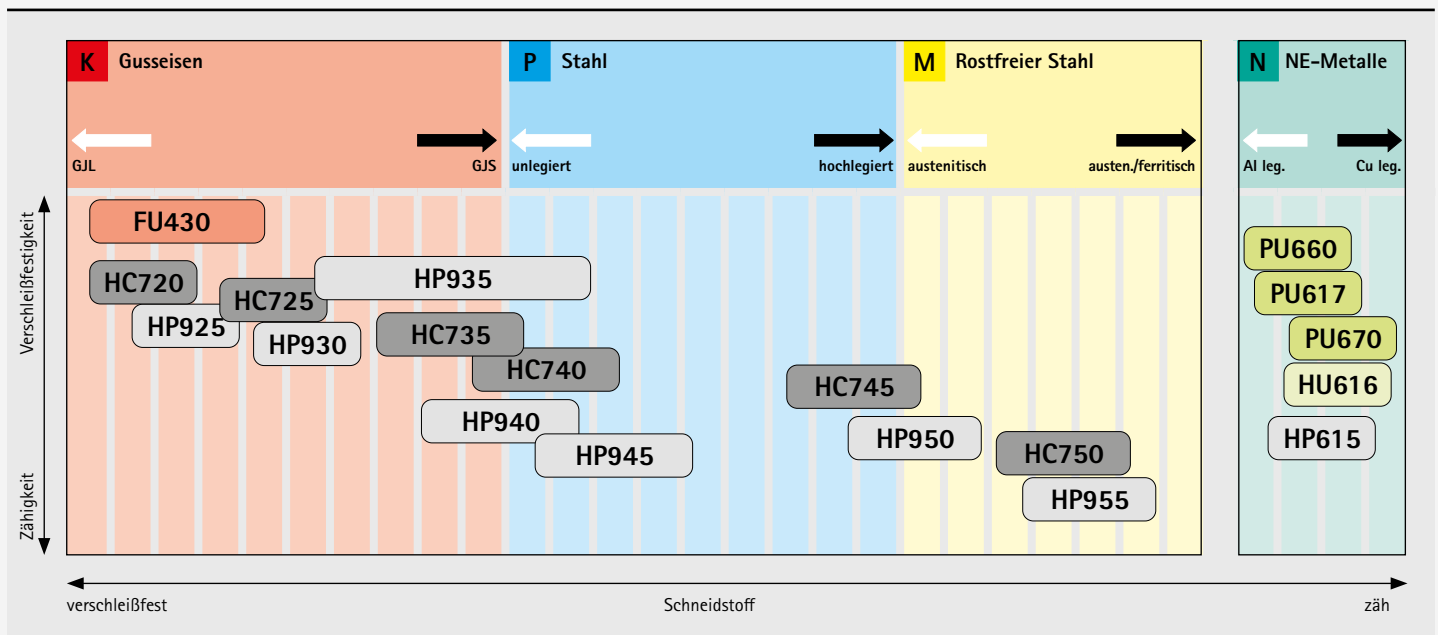

CVD PVD PcBN PKD unbeschichtet

Schneidstoffübersicht: Sorten und Sortenbeschreibung 1/2

Substrat	Beschichtung	Schneidstoff	Schichtzusammensetzung	Schichtfarbe	Einsatzbereich	Empfohlene Anwendung
Cermet	CVD-beschichtet	CC112	TiCN+Al ₂ O ₃	Mehrfarbig	●	Feinkorn-Cermetart mit Al ₂ O ₃ -Beschichtung zum Schlichten und Semibearbeitung von Stahl und Gusseisenwerkstoffen mit erhöhten Schnittgeschwindigkeiten.
PcBN	unbeschichtet	FU430	-	-	●	PcBN-Sorte mit hohem CBN-Gehalt zum Schlichten und Semischlichten von GJL und Sintermetall.
Hartmetall	CVD-beschichtet	HC698*	Diamant	Schwarz-Anthrazit	●	Hartmetall mit einer CVD-Diamantbeschichtung für die Bearbeitung von Aluminium.
		HC725	TiCN+Al ₂ O ₃	Schwarz	●	Feinkorn-Hartmetall mit großer Verschleißfestigkeit und einer mehrlagigen CVD-Beschichtung mit Al ₂ O ₃ -Deckschicht für die Bearbeitung von GJL und GJS bei hohen Schnittgeschwindigkeiten. Für glatten bis leicht unterbrochenen Schnitt für die mittlere bis Schruppbearbeitung.
		HC740	TiCN+Al ₂ O ₃	Schwarz	●	Feinkorn-Hartmetall mit großer Verschleißfestigkeit und einer mehrlagigen CVD-Beschichtung mit Al ₂ O ₃ -Deckschicht. Für glatten bis leicht unterbrochenen Schnitt für die mittlere bis Schruppbearbeitung in GJS, unlegierten Stählen sowie hitzebeständigem Stahlguss.
		HC745	TiCN+Al ₂ O ₃	Schwarz	⚡	Feinkorn-Hartmetall mit einem ausgewogenem Verhältnis von Verschleiß und Zähigkeit und einer mehrlagigen CVD-Beschichtung mit Al ₂ O ₃ -Deckschicht für die Bearbeitung bei höheren Schnittgeschwindigkeiten. Für unterbrochenen Schnitt oder instabile Verhältnisse und Werkstoffe mit erhöhter Zugfestigkeit und hochlegierten, bis zu rostfreien Stählen sowie hitzebeständigem Stahlguss.
		HC750	TiCN+Al ₂ O ₃	Schwarz	⚡	Feinkorn-Hartmetall mit einem ausgewogenem Verhältnis der Zähigkeit und einer mehrlagigen CVD-Beschichtung mit Al ₂ O ₃ -Deckschicht. Für unterbrochenen Schnitt oder instabile Verhältnisse und Werkstoffe mit höchster Zugfestigkeit, rostfreie Stähle bis zu hitzebeständigen Stahlgüssen.
		HC815	TiCN+Al ₂ O ₃	Schwarz	●	Verschleißfeste Feinkorn-Hartmetallsorte mit Al ₂ O ₃ -Beschichtung. Geeignet für die Bearbeitung von Gusseisenwerkstoffen bei stabilen Bedingungen.
		HC820	TiCN+Al ₂ O ₃	Schwarz	●	Al ₂ O ₃ -beschichtetes Hartmetall mit optimierter Nachbehandlung zur Steigerung der Kantenstabilität. Geeignet für die Bearbeitung von GJL bei stabilen Bedingungen und leicht unterbrochenem Schnitt.
		HC825	TiCN+Al ₂ O ₃	Schwarz	●	Erhöhte Verschleißbeständigkeit aufgrund dicker CVD-Beschichtung. Geeignet für die Bearbeitung von Guss bei instabilen Bedingungen.
		HC830	TiCN+Al ₂ O ₃	Schwarz	●	Feinkorn-Hartmetallsorte mit dicker Beschichtung und verbesserter Kantenstabilität. Geeignet für stark unterbrochenen Schnitt in Guss.
		HC850	TiCN+Al ₂ O ₃ +TiN	Gold	●	Gradienten-Hartmetall mit MT-TiCN- und Al ₂ O ₃ -Beschichtung und TiN-Decklage. Geeignet für die Bearbeitung von Stahl aufgrund der reduzierten Oberflächenrauheit.
		HC855	TiCN+Al ₂ O ₃ +TiN	Gold	●	Gradienten-Hartmetall mit ausgewogenem Verhältnis von Zähigkeit und Verschleißfestigkeit. Geeignet zum Semi-Finishing und für die mittlere Bearbeitung von Stahl.
		HC865	TiCN+Al ₂ O ₃ +TiN	Gold	⚡	Zähe Gradienten-Hartmetallsorte mit Al ₂ O ₃ -Beschichtung und glatter TiN-Decklage. Geeignet zum Semi-Finishing und für die mittlere Bearbeitung von Stahl und legiertem Stahl.
		HC875	TiCN+Al ₂ O ₃ +TiN	Gold	●	Feinkorn-Gradienten-Hartmetallsorte mit dünner CVD-Beschichtung. Geeignet für die Bearbeitung von hochlegiertem Stahl und rostfreiem Stahl.
		HC885	TiCN+Al ₂ O ₃ +TiN	Gold	⚡	Hartmetallsorte mit erhöhter Zähigkeit und CVD-Beschichtung. Geeignet für die Bearbeitung von rostfreiem Stahl.

* Schneidstoff zum Vollbohren von Aluminium.

Schneidstoffübersicht: Sorten und Sortenbeschreibung 2/2

Substrat	Beschichtung	Schneidstoff	Schichtzusammensetzung	Schichtfarbe	Einsatzbereich	Empfohlene Anwendung	
Hartmetall	PVD-beschichtet	HP615	TiB2	Anthrazit	●	Feinkorn-Hartmetall mit einer teilreduzierten PVD-Schicht zur Bearbeitung adhäsiver Materialien. Erste Wahl zur Standzeitverlängerung gegenüber unbeschichteten Schneiden in Aluminiumlegierungen mit 7-12 Prozent Silizium.	
		HP880	TiAlN	Anthrazit	●	Ausgezeichnete Verschleißfestigkeit und Hitzebeständigkeit aufgrund neuer PVD-Beschichtung. Geeignet zum Finishing von rostfreiem Stahl.	
		HP885	TiAlN + TiAlSiN	Kupfer	●	Temperaturbeständige Schneidstoffsorte, Feinstkorn-Hartmetall mit Multilayer PVD-Beschichtung zur universellen Bearbeitung von rostfreien Stählen.	
		HP895	TiAlN	Anthrazit	↔	TiAlN-beschichtetes Feinstkorn-Hartmetall mit hohem Bindergehalt. Optimiertes Zusammenspiel von Verschleißfestigkeit und Zähigkeit. Geeignet zum Semi-Finishing von rostfreiem Stahl.	
		HP930	AlTiCrN	Schwarz-Anthrazit	●	Feinkorn-Hartmetall mit PVD-Dickschicht. Sorte für die Semi- und Schrumpferspannung, für die Bearbeitung von GJL und GJS.	
		HP945	AlTiCrN	Schwarz-Anthrazit	↔	Feinkorn-Hartmetall mit PVD-Dickschicht. Zum Aufbohren von Stählen und rostfreien Stählen sowie hitzebeständigem Stahlguss.	
		HP950	TiAlSiN	Kupfer	↔	Zähes Feinkorn-Hartmetall mit PVD-Schicht. Zum Aufbohren von Werkstoffen mit höchster Zugfestigkeit, rostfreien Stählen und hitzebeständigem Stahlguss.	
	PVD-beschichtet, Mischbearbeitung	HP525-P	TiAlXN	Goldbraun	●	PVD-beschichtetes Hartmetall, besonders geeignet für die Mischbearbeitung von Aluminium und GJL/GJS bei glattem Schnitt.	
		HP530-P	TiAlXN	Goldbraun	●	PVD-beschichtetes Hartmetall, besonders geeignet für die Mischbearbeitung von Aluminium und GJL/GJS bei glattem bis leicht unterbrochenem Schnitt.	
		HP540-P	TiAlXN	Goldbraun	●	PVD-beschichtetes Hartmetall, besonders geeignet für die Mischbearbeitung von Aluminium und Sinterstahl bei glattem bis leicht unterbrochenem Schnitt.	
		HP545-P	TiAlXN	Goldbraun	●	PVD-beschichtetes Hartmetall mit einem ausgewogenem Verhältnis der Zähigkeit, besonders geeignet für die Mischbearbeitung von Aluminium und Sinterstahl bei leicht bis stark unterbrochenem Schnitt.	
	PKD	I	PU617	-	-	●	PKD-Sorte mit mittlerer Korngröße zur Schrump- bis Semibearbeitung in Nichteisenmetallen und zur Bearbeitung sehr abrasiver Materialien.
			PU660	-	-	●	Feinkörnige PKD-Sorte zum Schlichten von Nichteisenmetallen sowie nichtmetallischen Werkstoffen wie faserverstärkter Kunststoffe. Das Feinkorn verleiht der Schneide eine gute Schärfe (Schartigkeit) bei guter Verschleißfestigkeit für hohe erreichbare Oberflächengüten.
			PU670	-	-	↔	PKD-Schneidstoff mit mittlerer bis grober Korngröße. Hervorragende mechanische Verschleißfestigkeit bei guter Zähigkeit, besonders geeignet für die Bearbeitung von abrasiven Werkstoffen.

Bezeichnungsschlüssel Radial-Wendescheidplatten

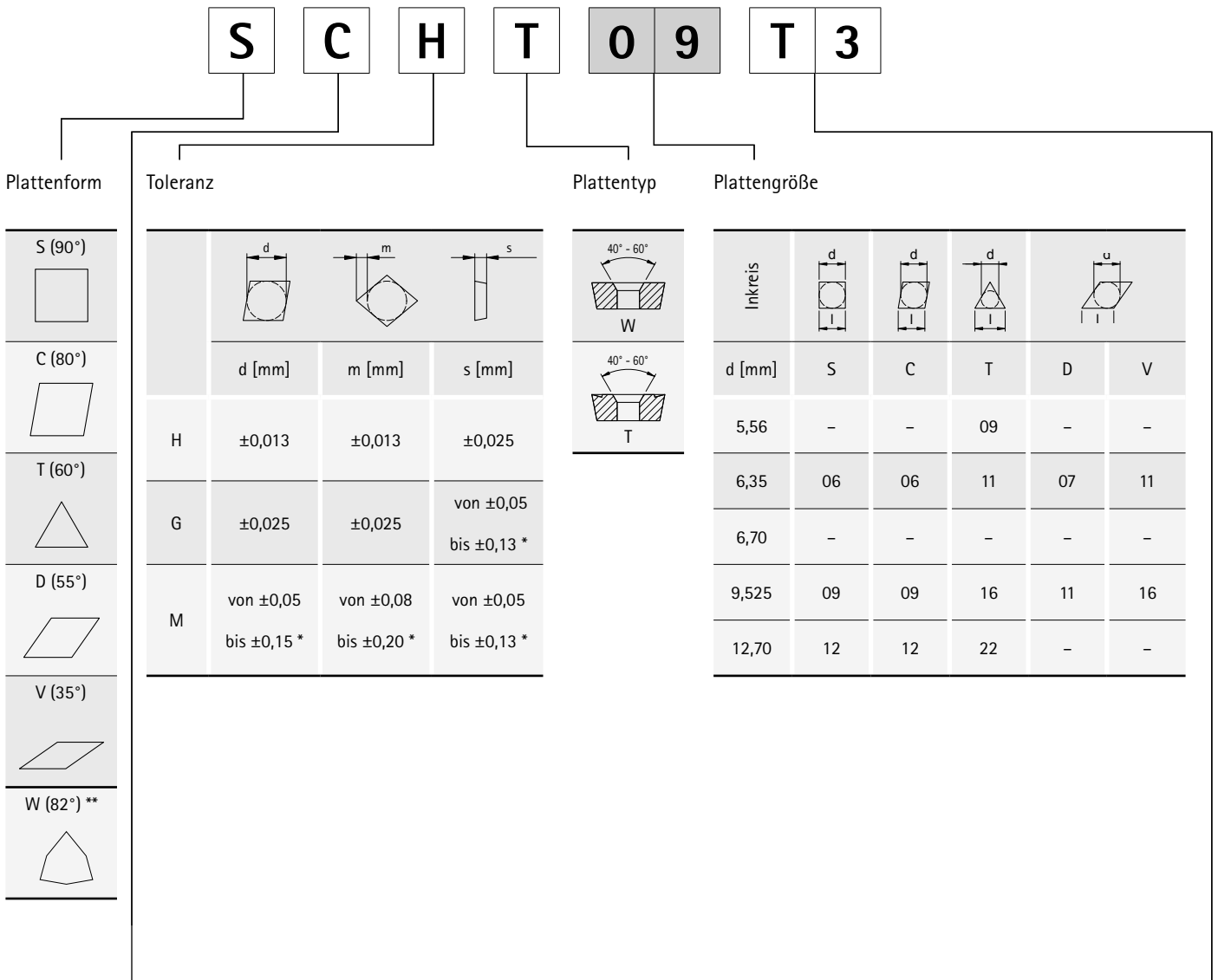

S (90°)	
C (80°)	
T (60°)	
D (55°)	
V (35°)	
W (82°) **	

	d [mm]	m [mm]	s [mm]
H	±0,013	±0,013	±0,025
G	±0,025	±0,025	von ±0,05 bis ±0,13 *
M	von ±0,05 bis ±0,15 *	von ±0,08 bis ±0,20 *	von ±0,05 bis ±0,13 *

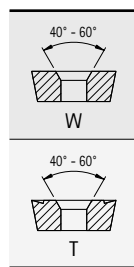

Inkreis					
d [mm]	S	C	T	D	V
5,56	-	-	09	-	-
6,35	06	06	11	07	11
6,70	-	-	-	-	-
9,525	09	09	16	11	16
12,70	12	12	22	-	-

Freiwinkel

B	5°
C	7°
P	11°
O	Sonderform

Plattendicke

Kennzahl	s [mm]
T1	1,98
02	2,38
03	3,18
T3	3,97
04	4,76

* Toleranz abhängig von der Plattengröße

** Vollbohren

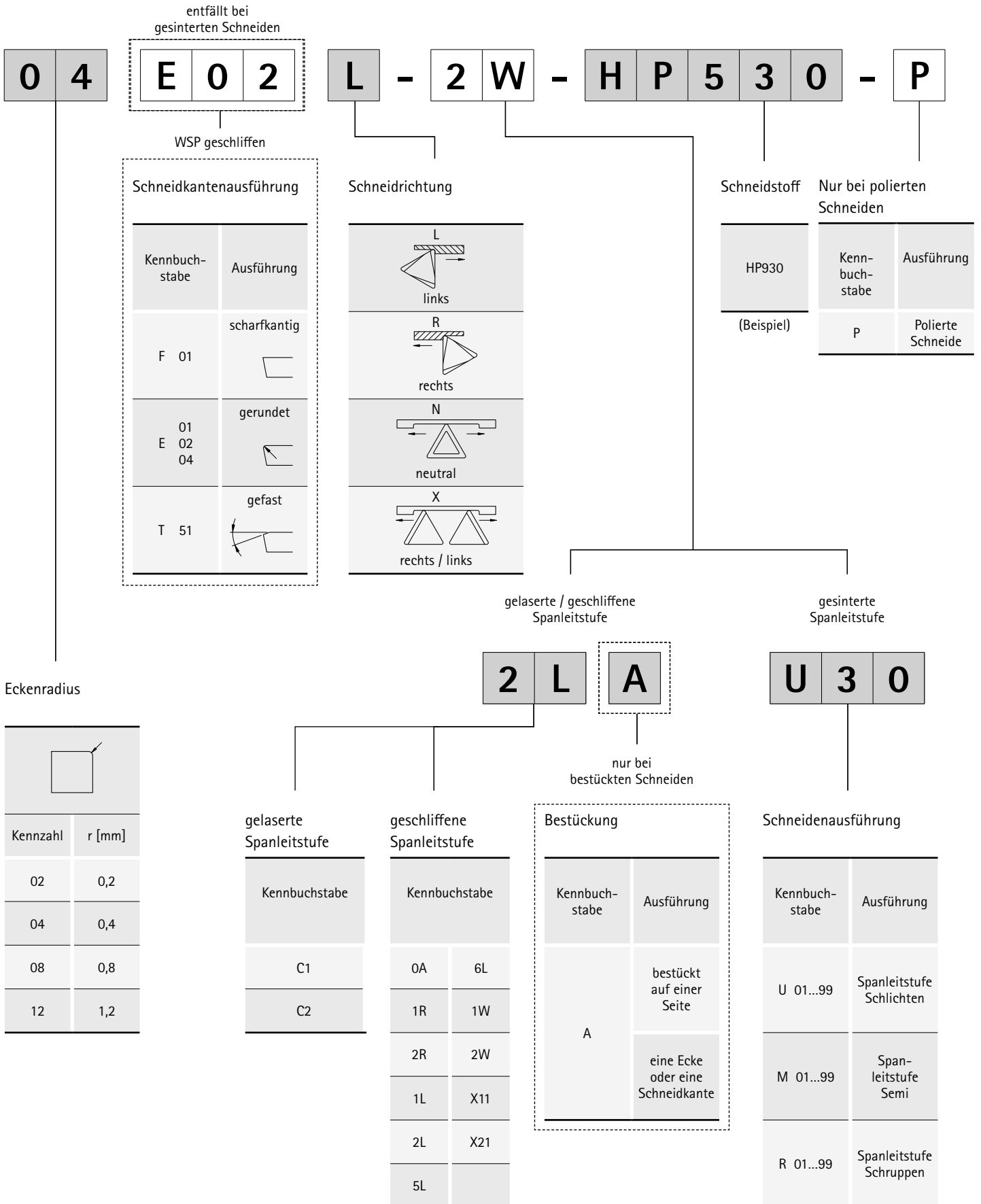

Bezeichnungsschlüssel Tangential-Wendescheidplatten

C T H Q 09 05 08

Plattenform

C (80°)
F (70°)
S (90°)

Toleranz

	d [mm]	s [mm]
H	±0,013	±0,025
G	±0,025	±0,13
N	±0,05 - ±0,15	±0,25

Plattentyp

Plattengröße

Inkreis			
d [mm]	C	F	S
6,35	06/09	06	06
9,525	09/13	09	09
12,7	12/18	12	-

WSP

T
Tangential

Plattendicke

	s [mm]
03	3,18
T3	3,97
04	4,76
05	5,56
06	6,35

Eckenradius

	r [mm]
00	0
04	0,4
08	0,8
12	1,2

H 0 2 **L** **0 0** **B 0 4 1** - **H P 9 4 5**

Schneidrichtung

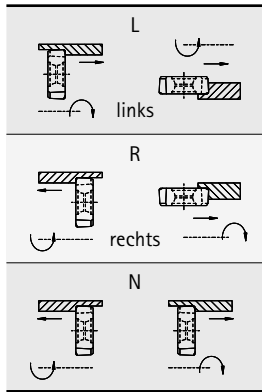

Anstellwinkel

Aufbohren	
Bogenschliff	
Kennzahl	Winkel
00	0°
10	10°

Schneidstoff

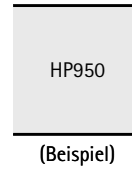

Spanleitstufe

Kennbuchstabe
A 01...99
D 01...99
G 01...99
H 01...99

Bogenschliff

Bogenschliff			
	Kennzahl	Radius	
Einbaulage	B012	12	CTHQ/FTHQ
	B016	16	
	B021	21	
	B041	40	
	B081	80	

Übersicht Spanleitstufen – Aufbohren

Radial-Wendeschneidplatten

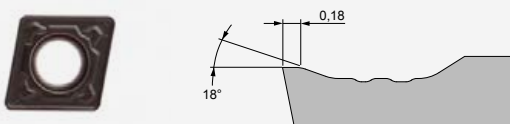
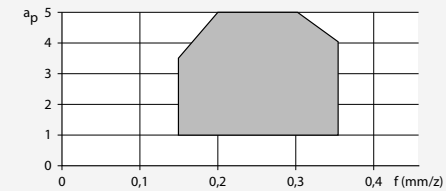
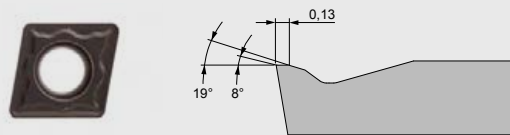
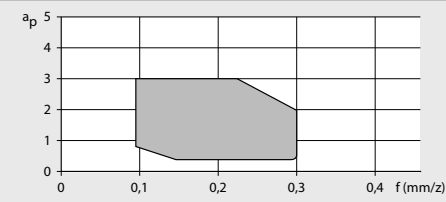
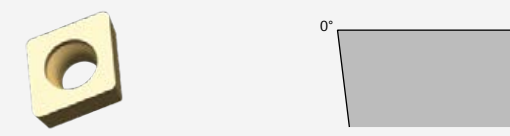
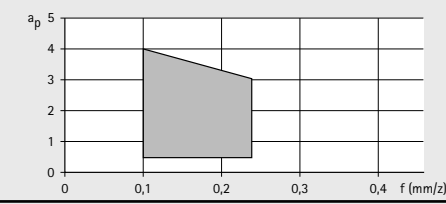
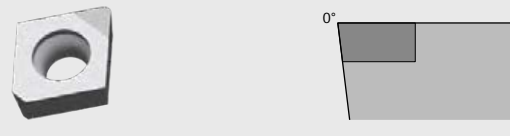
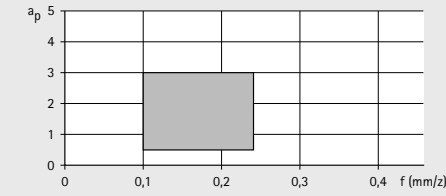



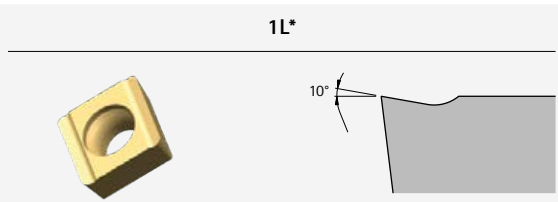
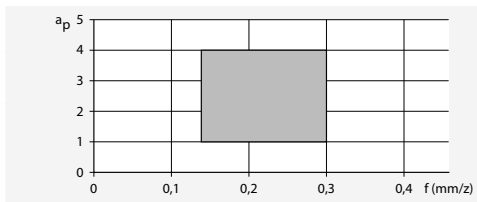
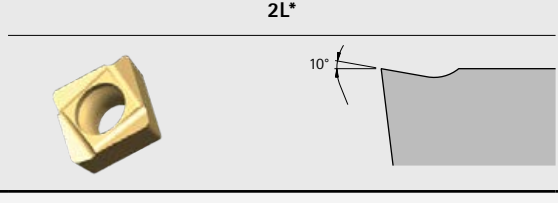
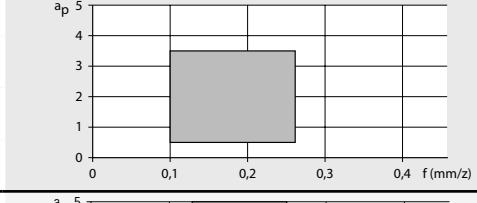
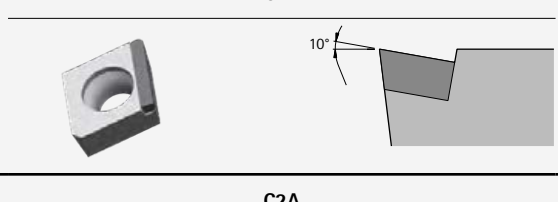
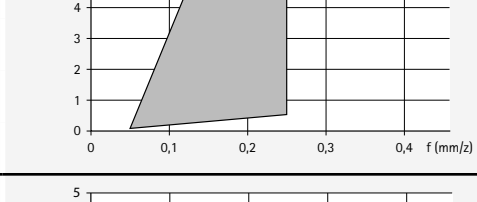
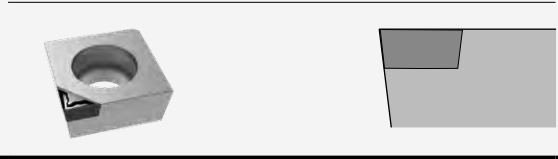
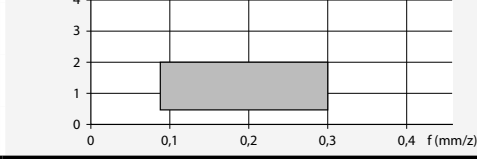
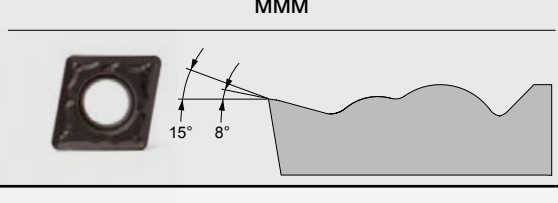
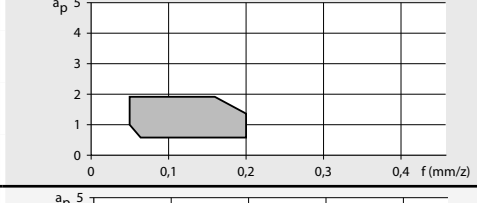
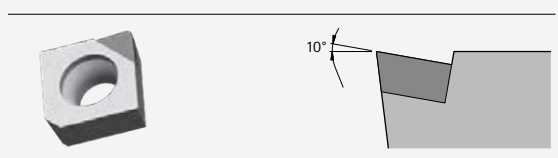
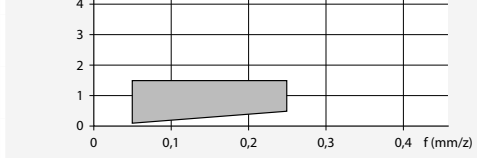
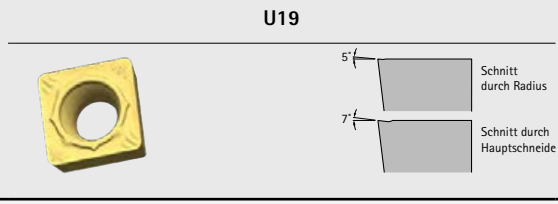
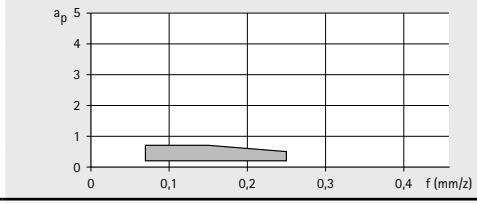
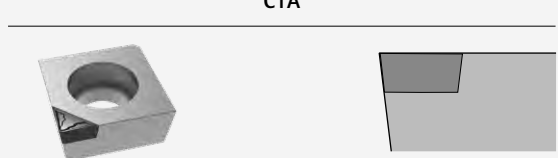
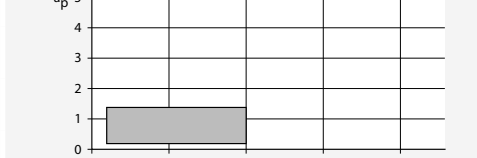



	Typ	Werkstoffgruppe	Kantenverrundung	Diagramm
Schruppen	MKM 	P M K N	+++	
	MGP 	P M K N	++	
Mittlere Bearbeitung	OA* 	P M K N	+ ++	
	OAA* 	P M K N	0 + ++	

* Diese Spanleitstufe ist mit verschiedenen Kantenverrundungen erhältlich.
 0 = scharfkantig | + = leicht verrundet | ++ = mittel verrundet | +++ = stark verrundet

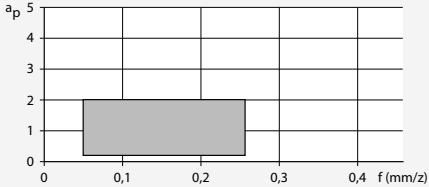
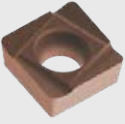
	Typ	Werkstoffgruppe	Kantenverrundung	Diagramm
Mittlere Bearbeitung	1L* 	P M K N	+ ++	
	2L* 	P M K N	+ ++	
	6LA 	P M K N	0	
	C2A 	P M K N	0	
Schlichten	MMM 	P M K N	++	
	5LA 	P M K N	0	
	U19 	P M K N	+	
	C1A 	P M K N	0	

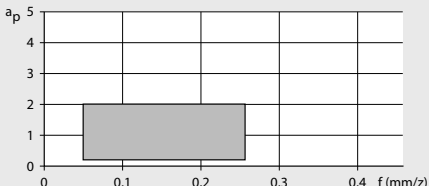
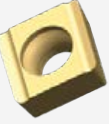
Übersicht Spanleitstufen – Aufbohren

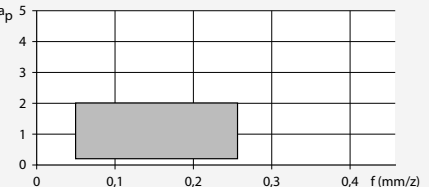
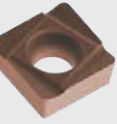
Radial-Wendeschneidplatten

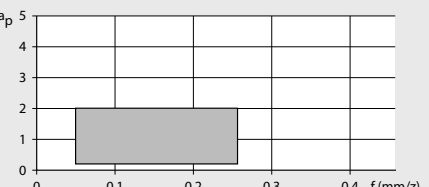
	Typ	Werkstoffgruppe	Kantenverrundung	Diagramm
Mischbearbeitung	1R*  	P M K N	0 +	
	2R*  	P M K N	0 +	
	1W  	P M K N	+	
	2W  	P M K N	+	

Kennzeichnung gepresste Wendeschneidplatten "press-to-size"





* Diese Spanleitstufe ist mit verschiedenen Kantenverrundungen erhältlich.
 0 = scharfkantig | + = leicht verrundet | ++ = mittel verrundet | +++ = stark verrundet

Notizen

Übersicht Spanleitstufen - Aufbohren

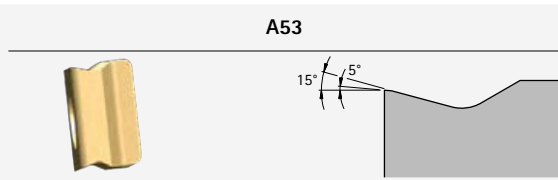
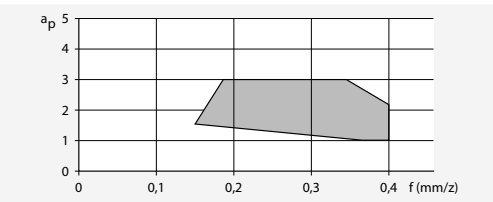
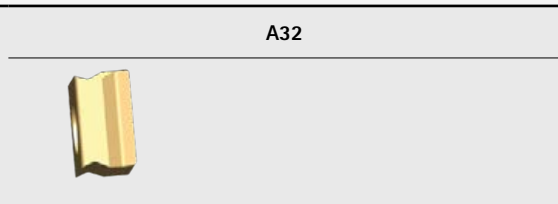
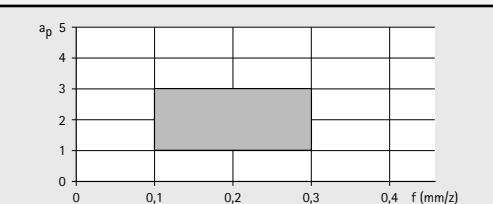
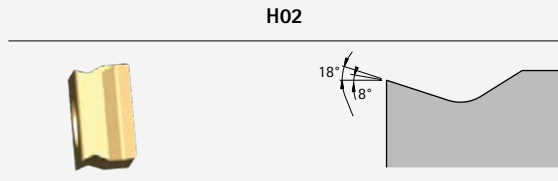
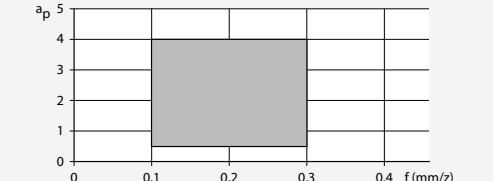
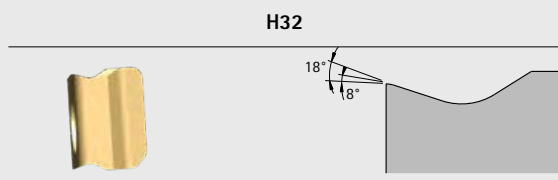
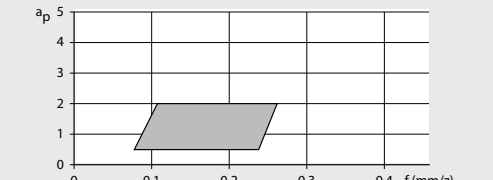
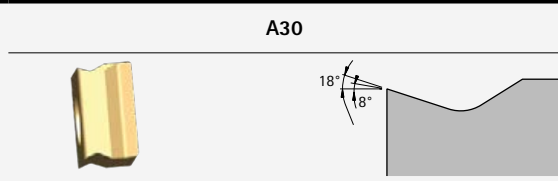
Tangential-Wendeschneidplatten

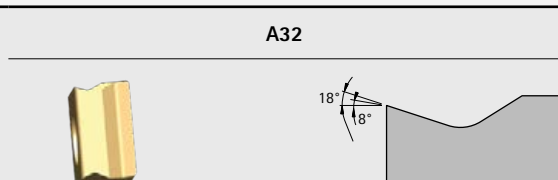
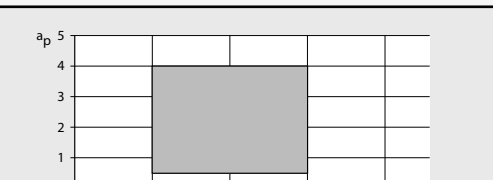
	Typ	Werkstoffgruppe	Kantenverrundung	Diagramm
Schruppen	A53 	P M K N	++	
	A32 	P M K N	++	
	H02 	P M K N	++	
	H32 	P M K K	++	
Mittlere Bearbeitung	A30 	P M K N	0	
	A32 	P M K N	++	

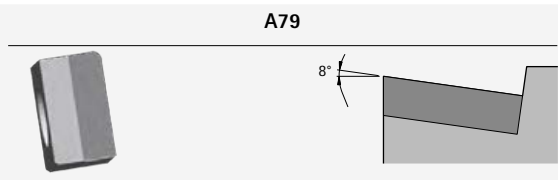
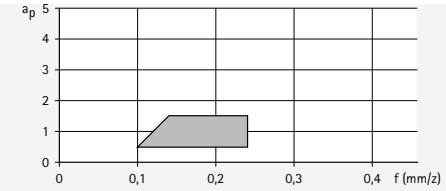
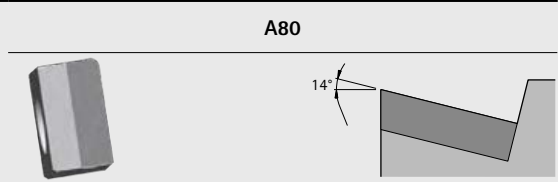
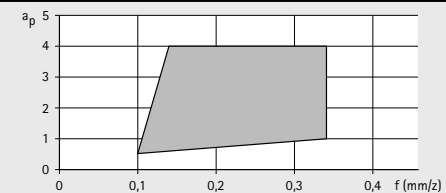
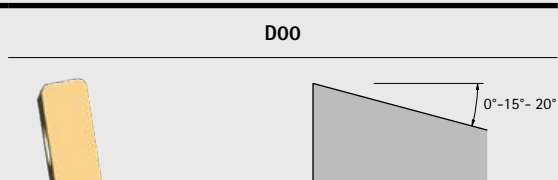
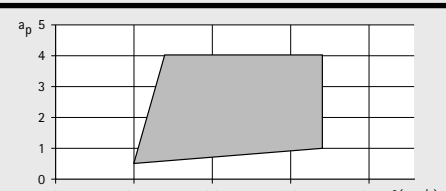
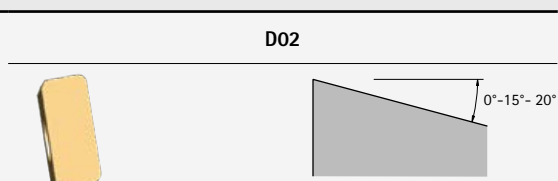
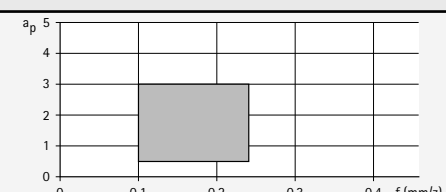
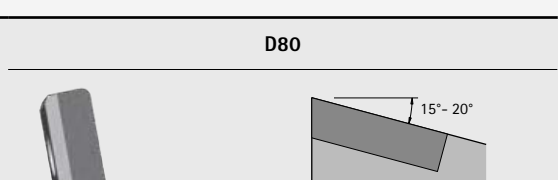
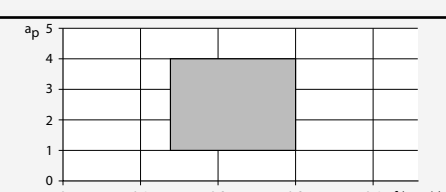
	Typ	Werkstoffgruppe	Kantenverrundung	Diagramm
Mittlere Bearbeitung	A79 	P M K N	0	
	A80 	P M K N	0	
Universell	D00 	P M K N	0	
	D02 	P M K N	++	
	D80 	P M K N	0	

CCMT

Radial-Wendeschneidplatte,
zweischneidig, neutrale Ausführung



Werkstoff	P				
	unlegiert ← verschleißfest		legiert → zäh	unlegiert ← verschleißfest	legiert → zäh
Substrat	Hartmetall				
Beschichtung	CVD			PVD	
Schneidstoffsorte	HC850	HC855	HC865	HP880	HP895

Schneidkantenausführung		MKM		MKM			
CCMT06	a_p max. [mm]						
Schruppen	CCMT060204N-...-	1,5 - 2,5					
	CCMT09						
	CCMT09T304N-...-	1,5 - 3,0			30966062		
		1,5 - 4,0					
	CCMT09T308N-...-	1,5 - 3,0	31265843		30985462		
		1,5 - 4,0					
	CCMT12						
	CCMT120408N-...-	1,5 - 4,0	31265844		30985477		
		1,5 - 5,0					
	CCMT120412N-...-	1,5 - 4,0	31265846		30985485		
1,5 - 5,0							

Schneidkantenausführung		MGP	MGP	MGP	MGP	MGP	
CCMT06	a_p max. [mm]						
Mittlere Bearbeitung	CCMT060202N-...-...	0,25 - 2,0					
	CCMT060204N-...-...	0,5 - 2,0		30985423		30985422	
	CCMT060208N-...-...	0,75 - 2,0	30985443			30985442	
	CCMT09						
	CCMT09T302N-...-...	0,25 - 3,0	30985451				
	CCMT09T304N-...-...	0,5 - 3,0		30985455	31092654	30966057	30966058
	CCMT09T308N-...-...	0,75 - 3,0	31265842	30985892	30985461	30985891	30985460
	CCMT12						
	CCMT120404N-...-...	0,5 - 3,0	30985470				
	CCMT120408N-...-...	0,75 - 3,0	30985473		30985474		
CCMT120412N-...-...	1,0 - 3,0	31265845		31092655			

Schneidkantenausführung		MMM		MMM	MMM	MMM	
CCMT06	a_p max. [mm]						
Schlichten	CCMT060202N-...-...	0,5 - 1,0	30985415			30985414	
	CCMT060204N-...-...	0,5 - 1,0	30985435		30985436	30985432	30985433
	CCMT060208N-...-...	0,5 - 1,0					30985448
	CCMT09						
	CCMT09T302N-...-...	0,5 - 1,0	30985453				30985452
	CCMT09T304N-...-...	0,5 - 1,0	30985887		30966053	30966070	30955706
	CCMT09T308N-...-...	0,5 - 1,0	30985465		30985896	30985894	30985895

Angegebene a_p-Bereiche sind Empfehlungen und können abhängig vom bearbeiteten Werkstoff variieren.

M					K				
austenitisch ← verschleißfest		ferritisch → zäh	austenitisch ← verschleißfest		ferritisch → zäh	GJL ← verschleißfest		GJS → zäh	
CVD					Hartmetall			Hartmetall	
CVD		Hartmetall			PVD			CVD	
HC875	HC885	HP880	HP885	HP895	HC820	HC830			
					MKM	MKM			
					30985425	30985427			
					30966120	30985884			
					30966113	30985893			
					30985475	30985476			
					30985481	30985483			
	MGP	MGP	MGP	MGP	MGP	MGP			
	30985420	30985421		31245556	30985422	30985413	30985417		
				31245557	30985442	30985439		30985419	
						30985450			
	30985883	30966056	30966057	31245558	30966058	30985882	30985454		
	30985459	30985890	30985891	31245559	30985460	30985888	30985889		
						30985467		30985469	
	30985899					30985472		30985898	
						30985479			
			MMM	MMM	MMM	MMM	MMM		
					30985414				
			30985432	31245539	30985433	30985429	30985431		
				31245541	30985448	30985445		30985447	
					30985452				
			30966070	31245543	30955706	30985885	30985886		
			30985894	31245545	30985895	30985463	30985464		

CCGT

Radial-Wendeschneidplatte,
zweischneidig, neutrale Ausführung



Hartmetall/Cermet

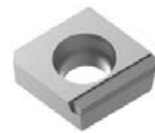

6LA



5LA



C1A



C2A

Bestückte Varianten,
einschneidig:

Werkstoff	P		M	N		
				Al leg. ← verschleißfest		Cu leg. → zäh
Substrat	Cermet	Hartmetall	Hartmetall	PKD		
Beschichtung	CVD	PVD	PVD	-		
Schneidstoffsorte	CC112	HP895	HP895	PU617	PU660	PU670

Schneidkantenausführung			MGP	MGP	6LA	C2A	
CCGT06		a_p max. [mm]					
Mittlere Bearbeitung	CCGT060202N-...-...	0,25 - 2,0	30985376	30985376			
	CCGT060204F01L-...-...	0,1 - 3,0			30708850		
	CCGT060204F01R-...-...	0,1 - 3,0			31277722		
	CCGT060204N-...-...	0,5 - 2,0	30985378	30985378			
	CCGT060208F01L-...-...	0,1 - 3,0			30375239		
	CCGT060208F01R-...-...	0,1 - 3,0			31204099		
	CCGT060208N-...-...	0,75 - 2,0	30985393	30985393			
	CCGT09						
	CCGT09T302N-...-...	0,25 - 3,0	30985398	30985398			
	CCGT09T304F01L-...-...	0,1 - 4,5			30370125		
	CCGT09T304F01R-...-...	0,1 - 4,5			30497774		
	CCGT09T304F01N-...-...	0,4 - 1,6				30234061	
	CCGT09T304N-...-...	0,5 - 3,0	30985400	30985400			
	CCGT09T308F01L-...-...	0,1 - 4,5			30370124		
	CCGT09T308F01R-...-...	0,1 - 4,5			30370397		
	CCGT09T308F01N-...-...	0,5 - 2,0				30234062	
	CCGT09T308N-...-...	0,75 - 3,0	30985406	30985406			
	CCGT12						
CCGT120404N-...-...	0,5 - 3,0	30985410	30985410				
CCGT120404F01L-...-...	0,1 - 7,0			31025433			
CCGT120408N-...-...	0,5 - 3,0	30985411	30985411				
CCGT120408F01L-...-...	0,1 - 7,0			30589862			

Schneidkantenausführung		U19		5LA	C1A	
CCGT06		a_p max. [mm]				
Schlichten	CCGT060204N-...-...	0,1 - 0,5	30874908			
	CCGT060204F01N-...-...	0,1 - 1,0		30708851	10104313	
	CCGT060208N-...-...	0,2 - 0,5	30799422			
	CCGT060208F01N-...-...	0,1 - 1,5		31277724		
	CCGT09					
	CCGT09T304F01N-...-...	0,1 - 2,0		31079089		
	CCGT09T304F01N-...-...	0,1 - 1,0			10099042	
	CCGT09T308F01N-...-...	0,1 - 2,0		31277725		
CCGT09T308F01N-...-...	0,15 - 1,4			30234050		

Angegebene a_p -Bereiche sind Empfehlungen und können abhängig vom bearbeiteten Werkstoff variieren.

CCGW

Radial-Wendeschneidplatten,
zweischneidig, neutrale Ausführung

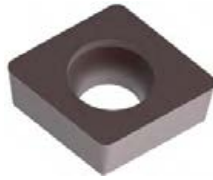

Bestückte Variante,
einschneidig:



OAA

Werkstoff	K			N	
	GJL ← verschleißfest	GJS → zäh	GJL ← verschleißfest	GJS → zäh	GJL ← verschleißfest
Substrat	Hartmetall			PcBN	PKD
Beschichtung	CVD		PVD	-	-
Schneidstoffsorte	HC740		HP930	FU430	PU617

Schneidkantenausführung		OA	OA	OAA		
CCGW06		a_p max. [mm]				
Mittlere Bearbeitung	CCGW060204E04N-...-...	0,5 - 3,2	31317178	30950259		
	CCGW060204T51N-...-...	0,5 - 2,0		10105523		
	CCGW060208E04N-...-...	0,5 - 3,2	31317202	30950280		
	CCGW09					
	CCGW09T304E04N-...-...	0,5 - 4,0	31027805	30950281		
	CCGW09T304T51N-...-...	0,5 - 2,5		10105636		
	CCGW09T308E04N-...-...	0,5 - 4,0	31023434	30950282		
	CCGW09T308T51N-...-...	0,5 - 2,5		10105650		
CCGW09T312E04N-...-...	0,5 - 4,0	31317207	30950283			

Schneidkantenausführung			OA	OAA	OAA	
CCGW06		a_p max. [mm]				
Schlichten	CCGW060202F01N-...-...	0,1 - 1,0			31277730	
	CCGW060204F01N-...-...	0,1 - 1,0			30492177	
	CCGW060204E01N-...-...	0,1 - 1,0		10105520		
	CCGW060204E02N-...-...	0,2 - 1,0		30950284		
	CCGW060208E02N-...-...	0,2 - 1,0		30950285		
	CCGW09					
	CCGW09T304F01N-...-...	0,1 - 1,0			30418983	
	CCGW09T304E01N-...-...	0,1 - 1,0		10105634		
	CCGW09T304E02N-...-...	0,2 - 2,0		30950286		
	CCGW09T308F01N-...-...	0,1 - 1,0			30492178	
	CCGW09T308E01N-...-...	0,1 - 1,0		10105648		
	CCGW09T308E02N-...-...	0,2 - 2,0		30950287		

CCHT

Radial-Wendeschneidplatten, zweischneidig, linke Ausführung

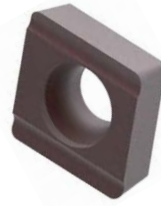

Werkstoff	K		N	
Substrat	Hartmetall		Hartmetall	
Beschichtung	CVD	PVD	-	PVD
Schneidstoffsorte	HC740	HP930	HU616	HP615

Schneidkantenausführung		1L	1L		1R	
CCHT06 a_p max. [mm]						
Mittlere Bearbeitung	CCHT060204E04L-...-...	0,5 - 3,2	31041976	30950288		
	CCHT060208E04L-...-...	0,5 - 3,2	31115820	30950289		
	CCHT09					
	CCHT09T302F01L-...-...	0,5 - 4,0				30492197
	CCHT09T304F01L-...-...	0,5 - 4,0				30478168
	CCHT09T304E04L-...-...	0,5 - 4,0	30963744	30950290		
	CCHT09T308F01L-...-...	0,5 - 4,0				30484471
	CCHT09T308E04L-...-...	0,5 - 4,0	30884324	30950291		
	CCHT09T312E04L-...-...	0,5 - 4,0	30884469	30950292		
	CCHT12					
	CCHT120404E04L-...-...	0,5 - 5,0	30963715	30950293		
	CCHT120408E04L-...-...	0,5 - 5,0	30894700	30950294		
CCHT120412E04L-...-...	0,5 - 5,0	31317213	30950295			

Schneidkantenausführung			1L	1R	1R	
CCHT06 a_p max. [mm]						
Schlichten	CCHT060202F01L-...-...	0,1 - 1,0			30010702	
	CCHT060204F01L-...-...	0,1 - 1,4			30010703	
	CCHT060204E02L-...-...	0,1 - 1,0		30950296		
	CCHT060208F01L-...-...	0,1 - 1,8			30010704	
	CCHT060208E02L-...-...	0,1 - 1,0		30950297		
	CCHT09					
	CCHT09T302F01L-...-...	0,1 - 2,0			30010705	30492197
	CCHT09T304F01L-...-...	0,1 - 2,0			30010706	30478168
	CCHT09T304E02L-...-...	0,1 - 2,0		30950298		
	CCHT09T308F01L-...-...	0,1 - 2,0			30010707	30484471
	CCHT09T308E02L-...-...	0,1 - 2,0		30950299		
	CCHT09T312F01L-...-...	0,1 - 2,0			30084580	
	CCHT12					
	CCHT120402F01L-...-...	0,1 - 3,0			30010708	
	CCHT120404F01L-...-...	0,1 - 3,0			30010709	
	CCHT120408F01L-...-...	0,1 - 3,0			30010710	
	CCHT120412F01L-...-...	0,1 - 3,0			30010711	

CCHT

Radial-Wendeschneidplatten, zweischneidig, rechte Ausführung



Werkstoff	K		N	
Substrat	Hartmetall		Hartmetall	
Beschichtung	CVD	PVD	-	PVD
Schneidstoffsorte	HC740	HP930	HU616	HP615

Schneidkantenausführung		1L	1L		1R
CCHT06	a_p max. [mm]				
CCHT060204E04R-...-...	0,5 - 3,2	31317208	30950300		
CCHT060208E04R-...-...	0,5 - 3,2	31317209	30950301		
CCHT09					
CCHT09T304F01R-...-...	0,5 - 4,0				30478169
CCHT09T304E04R-...-...	0,5 - 4,0	31115392	30950302		
CCHT09T308F01R-...-...	0,5 - 4,0				30492211
CCHT09T308E04R-...-...	0,5 - 4,0	31041977	30950303		
CCHT09T312E04R-...-...	0,5 - 4,0	31317210	30950304		
CCHT12					
CCHT120404E04R-...-...	0,5 - 5,0	31317211	30950305		
CCHT120408E04R-...-...	0,5 - 5,0	31317212	30950306		
CCHT120412E04R-...-...	0,5 - 5,0	31317214	30950307		

Schneidkantenausführung		1L	1R	1R
CCHT06	a_p max. [mm]			
CCHT060202F01R-...-...	0,1 - 1,0		30010732	
CCHT060204F01R-...-...	0,1 - 1,4		30010733	
CCHT060204E02R-...-...	0,1 - 1,0	30950308		
CCHT060208F01R-...-...	0,1 - 1,8		30010734	
CCHT060208E02R-...-...	0,1 - 1,0	30950309		
CCHT09				
CCHT09T302F01R-...-...	0,1 - 2,0		30010735	
CCHT09T304F01R-...-...	0,1 - 2,0		30010736	30478169
CCHT09T304E02R-...-...	0,1 - 2,0	30950310		
CCHT09T308F01R-...-...	0,1 - 2,0		30010737	30492211
CCHT09T308E02R-...-...	0,1 - 2,0	30950311		
CCHT09T312F01R-...-...	0,1 - 2,0		30492212	
CCHT12				
CCHT120402F01R-...-...	0,1 - 3,0		30010738	
CCHT120404F01R-...-...	0,1 - 3,0		30010739	
CCHT120408F01R-...-...	0,1 - 3,0		30010740	
CCHT120412F01R-...-...	0,1 - 3,0		30010741	

DCMT | DCGT | DCGW

Radial-Wendeschneidplatte, zweischneidig, neutrale Ausführung



Werkstoff	P				
	unlegiert verschleißfest		legiert zäh	unlegiert verschleißfest	legiert zäh
Substrat	Hartmetall				
Beschichtung	CVD			PVD	
Schneidstoffsorte	HC850	HC855	HC865	HP880	HP895

Schneidkantenausführung				MKM		
DCMT11		a_p max. [mm]				
Schruppen	DCMT11T304N-...-...	1,5 - 2,5		30966087		
		1,5 - 3,0				
	DCMT11T308N-...-...	1,5 - 3,0		30966078		
		1,5 - 4,0				

Schneidkantenausführung			MGP	MGP	MGP	MGP	MGP
DCMT07		a_p max. [mm]					
Mittlere Bearbeitung	DCMT070202N-...-...	0,25 - 1,8					
	DCMT070204N-...-...	0,5 - 2,0	30985499			30985498	
	DCMT070208N-...-...	0,75 - 2,0			31092658		
	DCMT11						
	DCMT11T304N-...-...	0,25 - 2,0	31092656	30985510	30966101	30966092	30966093
	DCMT11T308N-...-...	0,5 - 2,5	30966103	30985518		30966082	30966083
	DCGT11						
	DCGT11T304F01N-...-...	0,4 - 1,5					
	DCGT11T308F01N-...-...	0,5 - 1,8					
	DCMT15						
DCMT150404N-...-...	0,5 - 2,5						
DCMT150408N-...-...	0,5 - 3,0						
DCMT150412N-...-...	0,5 - 3,0						

Schneidkantenausführung			MMM		MMM	MMM	MMM
DCMT07		a_p max. [mm]					
Schlichten	DCMT070202N-...-...	0,5 - 1,0			30985495		30985494
	DCMT070204N-...-...	0,5 - 1,0	30986033				30985500
	DCMT070208N-...-...	0,5 - 1,0					
	DCMT11						
	DCMT11T302N-...-...	0,5 - 1,5	30966100				30985505
	DCMT11T304N-...-...	0,5 - 1,5	30985902		30966088	30966095	30966096
	DCMT11T308N-...-...	0,5 - 1,5	30966104		30966079	30966085	30966086
	DCGT11						
	DCGT11T304F01N-...-...	0,1 - 1,0					
	DCGT11T308F01N-...-...	0,15 - 1,4					
	DCGW11						
	DCGW11T304F01N-...-...	0,1 - 2,0					
	DCGW11T304E01N-...-...	0,1 - 1,0					
DCGW11T308F01N-...-...	0,1 - 2,0						
DCGW11T308F01N-...-...	0,1 - 1,0						

Angegebene a_p -Bereiche sind Empfehlungen und können abhängig vom bearbeiteten Werkstoff variieren.

Bestückte Variante,
einschneidig:

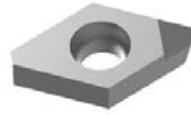

OAA



C1A



C2A

M					K			N			
austenitisch ← verschleißfest		ferritisch → zäh	austenitisch ← verschleißfest		ferritisch → zäh	GJL ← verschleißfest		GJS → zäh	Al leg. ← verschleißfest		Cu leg. → zäh
Hartmetall					Hartmetall		PcBN	PKD			
CVD		PVD			CVD		-	-			
HC875	HC885	HP880	HP885	HP895	HC815	HC825	FU430	PU617	PU660	PU670	
					MKM	MKM					
					30985511	30985512					
					30985519	30985520					
	MGP	MGP	MGP	MGP	MGP	MGP				C2A	
					30985493						
				30985498	30985496	30985497					
					30985501	30985502					
	30985508	30966091	30966092	31245560	30966093	30985506	30985507				
	30985517		30966082	31245562	30966083	30985515	30985516				
										30234066	
										30234067	
					30985522						
					30985523						
					30985524						
	MMM		MMM	MMM	MMM	MMM	OAA	OAA	1CA		
	30966105				30985494						
	30966107			31245546	30985500						
				31245547							
					30985505						
			30966095	31245548	30966096	30985513					
	30985903		30966085	31245549	30966086						
										30234052	
										30234053	
									31212079		
							10105921				
									31277726		
							10105952				

SCMT | SPMT | SCGT | SPGT

Radial-Wendeschneidplatte,
vierschneidig, neutrale Ausführung



Werkstoff	P					
		← unlegiert verschleißfest		legiert zäh →	← unlegiert verschleißfest	legiert zäh →
Substrat	Cermet	Hartmetall				
Beschichtung	CVD		CVD		PVD	
Schneidstoffsorte	CC112	HC850	HC855	HC865	HP880	HP895

Schneidkantenausführung			MKM		MKM		
SCMT09	a_p max. [mm]						
Schruppen	SCMT09T308N-...-...	1,5 - 3,0	31265847		30966072		
		1,5 - 4,0					
Schruppen	SCMT12						
	SCMT120408N-...-...	1,5 - 4,0	31265848		30985564		
		1,5 - 5,0					
	SCMT120412N-...-...	1,5 - 4,0	31265849				
		1,5 - 5,0					

Schneidkantenausführung			MGP	MGP	MGP		MGP
SPMT06	a_p max. [mm]						
Mittlere Bearbeitung	SPMT060304N-...-...	0,5 - 2,0	30985573		30985575		
	SPMT060308N-...-...	0,75 - 2,0			31265851		
Mittlere Bearbeitung	SCMT09						
	SCMT09T304N-...-...	0,5 - 3,0	31085129		31085141		30985536
	SCMT09T308N-...-...	0,75 - 3,0	31085140	30985543	30966127		
	SCMT09T312N-...-...	1 - 3,0	31276723		31273621		
	SCGT09						
	SCGT09T308F01N-...-...	0,5 - 2,0					
	SCMT12						
	SCMT120404N-...-...	0,5 - 3,0					
SCMT120408N-...-...	0,75 - 3,0	31085142	30985560	31085143			

Schneidkantenausführung			U19	MMM		MMM	MMM	MMM
SPMT06	a_p max. [mm]							
Schichten	SPMT060304N-...-...	0,5 - 2,0		30985579		30985580	30985577	30985913
	SPGT06							
	SPGT060304F01N-...-...	0,1 - 0,8						
	SPGT060304F01L-...-...	0,1 - 3,0						
	SPGT060304F01R-...-...	0,1 - 3,0						
	SPGT060308F01N-...-...	0,1 - 0,8						
	SPGT060308F01L-...-...	0,1 - 3,0						
	SPGT060308F01R-...-...	0,1 - 3,0						
	SCMT09							
	SCMT09T304N-...-...	0,5 - 1,5		31085144		31085145		30985540
	SCMT09T308N-...-...	0,5 - 1,5		30983531		30966073	30966076	30955704
	SCGT09							
	SCGT09T304N-...-...	0,1 - 0,5	30647885					
	SCGT09T304F01N-...-...	0,1 - 0,5						
SCGT09T304F01L-...-...	0,1 - 4,5							
SCGT09T304F01R-...-...	0,1 - 4,5							
SCGT09T308N-...-...	0,1 - 0,5	10102893						
SCGT09T308F01N-...-...	0,1 - 0,5							
SCGT09T308F01L-...-...	0,15 - 1,4							
SCGT09T308F01R-...-...	0,1 - 4,5							
SCGT09T308F01R-...-...	0,1 - 4,5							

Angegebene a_p -Bereiche sind Empfehlungen und können abhängig vom bearbeiteten Werkstoff variieren.

Bestückte Varianten,
einschneidig:

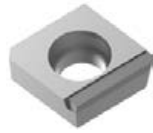

6LA



5LA



C1A



C2A

M				K		N					
austenitisch verschleißfest		ferritisch zäh	austenitisch verschleißfest		ferritisch zäh	GJL verschleißfest		GJS zäh	Al leg. verschleißfest		Cu leg. zäh
Hartmetall					PKD						
CVD		PVD			-						
HC875	HC885	HP880	HP895	HC820	HC830	PU617	PU660	PU670			
					MKM	MKM					
					30985545	31092659					
					30985562	31092660					
					30985566	31092661					
MGP		MGP		MGP	MGP	C2A					
					30985574	30985576					
					30985914	30985915					
30985535				30985536	30985908	30985534					
31092662					30985911	30985912					
											30249457
					30985552	30985554					
30985559					30985556	30985558					
MMM		MMM	MMM	MMM	MMM	5LA	6LA	C1A			
30972033		30985577	30985913	30985578	31084646						
											31277727
											30373268
											31279699
											31279698
											31217111
											31279720
		30966076	30985540	30985538	30985539						
			30955704	30985548	30985550						
											30374908
											30546951
											31279721
											30692832
											30250261
											30568596
											31279723

SCGW | SPGW

Radial-Wendeschneidplatten, vierschneidig



Bestückte Variante, einschneidig:

OAA

Werkstoff	K			N
	GJL ← verschleißfest	GJS → zäh	GJL ← verschleißfest	GJS → zäh
Substrat	Hartmetall		PcBN	PKD
Beschichtung	CVD		PVD	-
Schneidstoffsorte	HC740		HP930	FU430

Schneidkantenausführung		OA	OA	OAA	
SPGW06 a_p max. [mm]					
Mittlere Bearbeitung	SPGW060304E04N-...-...	0,5 - 3,2	31070945	30950312	
	SPGW060308E04N-...-...	0,5 - 3,2	31050739	30950313	
	SCGW09				
	SCGW09T304E04N-...-...	0,5 - 4,0	31022296	30950314	
	SCGW09T304T51N-...-...	0,5 - 2,5			10106285
	SCGW09T308E04N-...-...	0,5 - 4,0	31022297	30950315	
	SCGW09T308T51N-...-...	0,5 - 2,5			10106299
	SCGW12				
	SCGW120404E04N-...-...	0,5 - 5,0	31317220	30950316	
	SCGW120408E04N-...-...	0,5 - 5,0	30939413	30950317	

Schneidkantenausführung			OA	OAA	OAA
SPGW06 a_p max. [mm]					
Schlichten	SPGW060304F01N-...-...	0,1 - 1,2			31277731
	SPGW060304E02N-...-...	0,2 - 1,0		30950318	
	SPGW060308F01N-...-...	0,1 - 1,0			31279738
	SPGW060308E02N-...-...	0,2 - 1,0		30950319	
	SCGW09				
	SCGW09T304F01N-...-...	0,1 - 1,4			31277732
	SCGW09T304E01N-...-...	0,1 - 1,0			10106283
	SCGW09T304E02N-...-...	0,2 - 2,0		30950320	
	SCGW09T308F01N-...-...	0,1 - 1,8			30429723
	SCGW09T308E01N-...-...	0,1 - 1,0			10106297
	SCGW09T308E02N-...-...	0,2 - 2,0		30950321	
	SCGW12				
	SCGW120404F01N-...-...	0,1 - 1,4			31279752
SCGW120408F01N-...-...	0,1 - 1,8			31279753	

Angegebene a_p -Bereiche sind Empfehlungen und können abhängig vom bearbeiteten Werkstoff variieren.

SCHT | SPHT

Radial-Wendeschneidplatten, zweischneidig, neutrale Ausführung



Werkstoff	K		N	
	GJL ← verschleißfest	GJS → zäh	GJL ← verschleißfest	GJS → zäh
Substrat	Hartmetall			Hartmetall
Beschichtung	CVD		PVD	
Schneidstoffsorte	HC740		HP930	

Schneidkantenausführung		1L	1L		
SPHT06 a_p max. [mm]					
Mittlere Bearbeitung	SPHT060304E04X-...-...	0,5 - 3,2	31042317	30953122	
	SPHT060308E04X-...-...	0,5 - 3,2	31317315	30953126	
	SCHT09				
	SCHT09T304E04X-...-...	0,5 - 4,0	31121604	30953127	
	SCHT09T308E04X-...-...	0,5 - 4,0	30963756	30953128	
	SCHT09T312E04X-...-...	0,5 - 4,0	31317219	30953150	
	SCHT12				
	SCHT120404E04X-...-...	0,5 - 5,0	31081857	30953151	
	SCHT120408E04X-...-...	0,5 - 5,0	31317304	30953152	
	SCHT120412E04X-...-...	0,5 - 5,0	31317308	30953154	

Schneidkantenausführung			1L	1R	
SPHT06 a_p max. [mm]					
Schlichten	SPHT060304E02X-...-...	0,1 - 1,0	30953158		
	SPHT060308E02X-...-...	0,1 - 1,0	30953164		
	SCHT09				
	SCHT09T302F01X-...-...	0,1 - 2,0		30141062	
	SCHT09T304F01X-...-...	0,1 - 2,0		30010681	
	SCHT09T304E02X-...-...	0,1 - 2,0	30953159		
	SCHT09T308F01X-...-...	0,1 - 2,0		30010682	
	SCHT09T308E02X-...-...	0,1 - 2,0	30953168		
	SCHT09T312F01X-...-...	0,1 - 2,0		30492274	
	SCHT12				
SCHT120404F01X-...-...	0,1 - 3,0		30010683		
SCHT120408F01X-...-...	0,1 - 3,0		30010684		

SCHT | SPHT

Radial-Wendeschneidplatten, vierschneidig



linke Ausführung

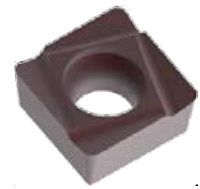

rechte Ausführung

Werkstoff	K		N	
	GJL ← verschleißfest	GJS → zäh	GJL ← verschleißfest	GJS → zäh
Substrat	Hartmetall		Hartmetall	
Beschichtung	CVD		-	PVD
Schneidstoffsorte	HC740		HU616	HP615

Schneidkantenausführung		2L	2L		2R	
SPHT06		<i>a_p max. [mm]</i>				
Mittlere Bearbeitung	SPHT060302F01L-...-...	0,5 - 3,2			30492231	
	SPHT060302F01R-...-...	0,5 - 3,2			30492248	
	SPHT060304F01L-...-...	0,5 - 3,2			30239958	
	SPHT060304F01R-...-...	0,5 - 3,2			30492249	
	SPHT060304E04L-...-...	0,5 - 3,2	31044035	30950322		
	SPHT060304E04R-...-...	0,5 - 3,2	30939004	30950346		
	SPHT060308F01L-...-...	0,5 - 3,2			30492232	
	SPHT060308F01R-...-...	0,5 - 3,2			30492250	
	SPHT060308E04L-...-...	0,5 - 3,2	31317311	30950323		
	SPHT060308E04R-...-...	0,5 - 3,2	31317314	30950347		
	SCHT09					
	SCHT09T304F01L-...-...	0,5 - 4,0			30492235	
	SCHT09T304F01R-...-...	0,5 - 4,0			30492252	
	SCHT09T304E04L-...-...	0,5 - 4,0	31043583	30950324		
	SCHT09T304E04R-...-...	0,5 - 4,0	30812298	30950348		
	SCHT09T308F01L-...-...	0,5 - 4,0			30042582	
	SCHT09T308F01R-...-...	0,5 - 4,0			30492253	
	SCHT09T308E04L-...-...	0,5 - 4,0	31039585	30950325		
	SCHT09T308E04R-...-...	0,5 - 4,0	31317215	30950349		
	SCHT09T312E04L-...-...	0,5 - 4,0	31317216	30950326		
SCHT09T312E04R-...-...	0,5 - 4,0	31317217	30950350			
SCHT12						
SCHT120404E04L-...-...	0,5 - 5,0	31317284	30950327			
SCHT120404E04R-...-...	0,5 - 5,0	31317287	30950351			
SCHT120408E04L-...-...	0,5 - 5,0	31317300	30950328			
SCHT120408E04R-...-...	0,5 - 5,0	31317301	30950352			
SCHT120412E04L-...-...	0,5 - 5,0	31317305	30950329			
SCHT120412E04R-...-...	0,5 - 5,0	31317307	30950353			

Nächste Tabelle:
Schlichten



SCHT | SPHT

Radial-Wendeschneidplatten, vierschneidig



linke Ausführung

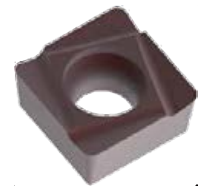

rechte Ausführung

Werkstoff	K	N	Cu leg. → zäh
	Al leg. ← verschleißfest		
Substrat	Hartmetall		
Beschichtung	PVD	-	PVD
Schneidstoffsorte	HP930	HU616	HP615

Schneidkantenausführung		2L	2R	2R	
SPHT06					
	a_p max. [mm]				
Schichten	SPHT060302F01L-...-...	0,1 - 1,0	30092077	30492231	
	SPHT060302F01R-...-...	0,1 - 1,0	30089678	30492248	
	SPHT060304F01L-...-...	0,1 - 1,0	30010644	30239958	
	SPHT060304F01R-...-...	0,1 - 1,0	30010662	30492249	
	SPHT060304E02L-...-...	0,1 - 1,0	30950330		
	SPHT060304E02R-...-...	0,1 - 1,0	30950354		
	SPHT060308F01L-...-...	0,1 - 1,0	30057636	30492232	
	SPHT060308F01R-...-...	0,1 - 1,0	30438143	30492250	
	SPHT060308E02L-...-...	0,1 - 1,0	30950331		
	SPHT060308E02R-...-...	0,1 - 1,0	30950355		
	SCHT09				
	SCHT09T304F01L-...-...	0,1 - 2,0		30010645	30492235
	SCHT09T304F01R-...-...	0,1 - 2,0		30010663	30492252
	SCHT09T304E02L-...-...	0,1 - 2,0	30950332		
SCHT09T304E02R-...-...	0,1 - 2,0	30950356			
SCHT09T308F01L-...-...	0,1 - 2,0		30010646	30042582	
SCHT09T308F01R-...-...	0,1 - 2,0		30010664	30492253	
SCHT09T308E02L-...-...	0,1 - 2,0	30950333			
SCHT09T308E02R-...-...	0,1 - 2,0	30950357			

TCMT | TCGW

Radial-Wendeschneidplatte, dreischneidig, neutrale Ausführung



Werkstoff	P			
	← unlegiert verschleißfest	legiert zäh	← unlegiert verschleißfest	legiert zäh →
Substrat	Hartmetall			
Beschichtung	CVD		PVD	
Schneidstoffsorte	HC850	HC865	HP880	HP895

Schneidkantenausführung		MKM			
TCMT11		ap max. [mm]			
Schruppen	TCMT110204N-...-...	1,5 - 3,0		30985591	
		1,5 - 4,0			
	TCMT16				
	TCMT16T304N-...-...	1,5 - 3,0		30985608	
		1,5 - 5,0			
	TCMT16T308N-...-...	1,5 - 3,0		30985615	
	1,5 - 5,0				

Schneidkantenausführung		MGP		MGP		MGP	
TCMT09		ap max. [mm]					
Mittlere Bearbeitung	TCMT090204N-...-...	0,5 - 2,0	30985582				
	TCMT11						
	TCMT110204N-...-...	0,5 - 2,5	30945048	30985589		30985588	
	TCMT110208N-...-...	0,75 - 2,5	30985599	30985600		30985601	
	TCGW11						
	TCGW110204T51N-...-...	0,5 - 2,5					
	TCGW110208T51N-...-...	0,75 - 2,5					
	TCMT16						
	TCMT16T304N-...-...	0,5 - 2,5	30985605	31092663		30985604	
	TCMT16T308N-...-...	0,75 - 2,5	30985613	31092665		30985612	
TCMT16T312N-...-...	1,0 - 2,5		31092666				
TCMT22							
TCMT220408N-...-...	0,75 - 3,0						

Schneidkantenausführung		MMM		MMM		MMM	
TCMT11		ap max. [mm]					
Schlichten	TCMT110202N-...-...	0,5 - 1,5	30985584	30985585		30985583	
	TCMT110204N-...-...	0,5 - 1,5	30985595	30985596	30985593	30985594	
	TCMT110208N-...-...	0,5 - 1,5					
	TCGW11						
	TCGW110204F01N-...-...	0,1 - 1,0					
	TCGW110204E01N-...-...	0,1 - 1,0					
	TCGW110208F01N-...-...	0,1 - 1,5					
	TCGW110208E01N-...-...	0,1 - 1,0					
	TCMT16						
TCMT16T304N-...-...	0,5 - 1,5				30985609		
TCMT16T308N-...-...	0,5 - 1,5				30985617		

Angegebene ap-Bereiche sind Empfehlungen und können abhängig vom bearbeiteten Werkstoff variieren.

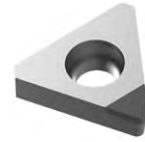

Bestückte Variante,
einschneidig:

0AA

M				K			N
austenitisch ← verschleißfest		ferritisch → zäh		GJL ← verschleißfest		GJS → zäh	
Hartmetall				Hartmetall		PcBN	PKD
CVD		PVD		CVD		-	-
HC875	HP880	HP885	HP895	HC815	HC825	FU430	PU617
				MKM			
				30985590			
				30985607			
				30985614			
	MGP		MGP	MGP	MGP	OAA	
				30985917			
30985587			30985588	30985586			
30985598		31245563	30985601	30985597			
						30227880	
						30227892	
			30985604	30985602	30985603		
			30985612	30985610	30985611		
		31245564		30985618	30985619		
				30985622	30985623		
	MMM	MMM	MMM	MMM		OAA	OAA
			30985583				
	30985593	31245550	30985594	30985592			
		31245551					
							31279724
						30227878	
						30227890	31279725
		31245552	30985609				
30985616		31245553	30985617				

Angegebene a_p -Bereiche sind Empfehlungen und können abhängig vom bearbeiteten Werkstoff variieren.

TCHT

Radial-Wendeschneidplatten, dreischneidig, linke/rechte Ausführung



linke Ausführung



rechte Ausführung

Werkstoff	K		N
	Hartmetall		Hartmetall
Substrat	Hartmetall		Hartmetall
Beschichtung	CVD	PVD	
Schneidstoffsorte	HC740	HP930	HU616

Schneidkantenausführung		2L	2L		
TCHT09 a_p max. [mm]					
Mittlere Bearbeitung	TCHT090204E04L-...-...	0,5 - 2,5	31317317	30950224	
	TCHT090204E04R-...-...	0,5 - 2,5	31317318	30950235	
	TCHT090208E04L-...-...	0,5 - 2,5	31317319	30950225	
	TCHT090208E04R-...-...	0,5 - 2,5	31317320	30950236	
	TCHT11				
	TCHT110204E04L-...-...	0,5 - 3,0	31317321	30950226	
	TCHT110204E04R-...-...	0,5 - 3,0	31317322	30950237	
	TCHT110208E04L-...-...	0,5 - 3,0	31317325	30950227	
	TCHT110208E04R-...-...	0,5 - 3,0	31317326	30950238	
	TCHT16				
	TCHT16T304E04L-...-...	0,5 - 4,0	31317327	30950228	
	TCHT16T304E04R-...-...	0,5 - 4,0	31317328	30950239	
	TCHT16T308E04L-...-...	0,5 - 4,0	31317340	30950229	
	TCHT16T308E04R-...-...	0,5 - 4,0	31317342	30950240	

Schneidkantenausführung			2L	2R	
TCHT06 a_p max. [mm]					
Schlichten	TCHT06T104F01L-...-...	0,1 - 1,0		30492290	
	TCHT06T104F01R-...-...	0,1 - 1,0		30492307	
	TCHT06T104E02L-...-...	0,1 - 1,0		30950230	
	TCHT06T104E02R-...-...	0,1 - 1,0		30950241	
	TCHT09				
	TCHT090204F01L-...-...	0,1 - 1,0		30010759	
	TCHT090204F01R-...-...	0,1 - 1,0		30010777	
	TCHT090204E02L-...-...	0,1 - 1,0		30950231	
	TCHT090204E02R-...-...	0,1 - 1,0		30950242	
	TCHT090208E02L-...-...	0,1 - 1,0		30950232	
	TCHT090208E02R-...-...	0,1 - 1,0		30950243	
	TCHT11				
	TCHT110202F01L-...-...	0,1 - 1,5		30010761	
	TCHT110202F01R-...-...	0,1 - 1,5		30010779	
	TCHT110204F01L-...-...	0,1 - 1,5		30010762	
	TCHT110204F01R-...-...	0,1 - 1,5		30010780	
	TCHT110204E02L-...-...	0,1 - 1,5		30950233	
	TCHT110204E02R-...-...	0,1 - 1,5		30950244	
	TCHT110208F01L-...-...	0,1 - 1,5		30010763	
	TCHT110208F01R-...-...	0,1 - 1,5		30478186	
	TCHT110208E02L-...-...	0,1 - 1,5		30950234	
	TCHT110208E02R-...-...	0,1 - 1,5		30950245	
	TCHT16				
	TCHT16T304F01L-...-...	0,1 - 2,5		30478187	
	TCHT16T304F01R-...-...	0,1 - 2,5		30478188	
	TCHT16T308F01L-...-...	0,1 - 2,5		30019882	
	TCHT16T308F01R-...-...	0,1 - 2,5		30478189	

Angegebene a_p -Bereiche sind Empfehlungen und können abhängig vom bearbeiteten Werkstoff variieren.

TCHT

Radial-Wendeschneidplatten, einschneidig, neutrale Ausführung

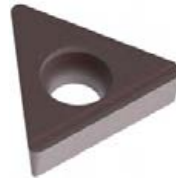

Werkstoff	K		N
	Hartmetall		Hartmetall
Substrat	Hartmetall		Hartmetall
Beschichtung	CVD	PVD	
Schneidstoffsorte	HC740	HP930	HU616

Schneidkantenausführung		1L	1L	
TCHT09		a_p max. [mm]		
Mittlere Bearbeitung	TCHT090204E04X-...-...	0,5 - 2,5	31319106	30950246
	TCHT090208E04X-...-...	0,5 - 2,5	31319107	30950247
	TCHT11			
	TCHT110204E04X-...-...	0,5 - 3,0	31319108	30950248
	TCHT110208E04X-...-...	0,5 - 3,0	31319109	30950249
	TCHT16			
	TCHT16T304E04X-...-...	0,5 - 4,0	31039581	30950250
TCHT16T308E04X-...-...	0,5 - 4,0	31319140	30950251	

Schneidkantenausführung			1L	1R
TCHT06		a_p max. [mm]		
Schlichten	TCHT06T104F01X-...-...	0,1 - 1,0		30492325
	TCHT06T104E02X-...-...	0,1 - 1,0	30950252	
	TCHT09			
	TCHT090204F01X-...-...	0,1 - 1,0		30010795
	TCHT090204E02X-...-...	0,1 - 1,0	30950253	
	TCHT090208E02X-...-...	0,1 - 1,0	30950254	
	TCHT11			
	TCHT110202F01X-...-...	0,1 - 1,5		30010797
	TCHT110204F01X-...-...	0,1 - 1,5		30010798
	TCHT110204E02X-...-...	0,1 - 1,5	30950255	
	TCHT110208F01X-...-...	0,1 - 1,5		30010799
	TCHT110208E02X-...-...	0,1 - 1,5	30950256	
	TCHT16			
	TCHT16T304F01X-...-...	0,1 - 2,5		30019940
TCHT16T308F01X-...-...	0,1 - 2,5		30019941	

VCMT | VCGT | VBGW | VCGW

Radial-Wendeschneidplatten, zweischneidig, neutrale Ausführung



Werkstoff	P		
	unlegiert ← verschleißfest		legiert → zäh
Substrat	Hartmetall		
Beschichtung	CVD		PVD
Schneidstoffsorte	HC850	HC865	HP880
Schneidkantenausführung			
VCMT16		MKM	
a_p max. [mm]			
Schruppen	VCMT160408N-...-...	1,5 - 3,0	30985630
	Schneidkantenausführung		
VCGT11		MGP	MGP
a_p max. [mm]			
Mittlere Bearbeitung	VCGT110304N-...-...	0,25 - 2,0	30966122
	VCMT16		
	VCMT160404N-...-...	0,5 - 2,0	30966097
	VCMT160408N-...-...	0,75 - 2,0	31093307
Schneidkantenausführung			
VBGW16			
a_p max. [mm]			
Schlichten	VBGW160404E01N-...-...	0,1 - 1,0	
	VBGW160408E01N-...-...	0,1 - 1,0	
	VCGW16		
	VCGW160404E01N-...-...	0,1 - 1,0	
VCGW160408E01N-...-...	0,1 - 1,0		



Bestückte Variante,
einschneidig:

OAA

	M	K	
	Hartmetall	Hartmetall	PcBN
	PVD	CVD	-
	HP880	HC815	FU430
	MGP	MGP	
	30966122		
		30985627	
		30985628	
			OAA
			10106686
			10106698
			10106768
			10106780

CCHT | Mischbearbeitung

Radial-Wendeschneidplatten, zweischneidig, Mischbearbeitung



rechte Ausführung



linke Ausführung

Werkstoff	N + K		N + P			
	GJL ← verschleißfest	GJS → zäh	unlegiert ← verschleißfest	legiert → zäh		
Substrat	Hartmetall		Hartmetall			
Beschichtung	PVD		PVD			
Schneidstoffsorte	HP525-P	HP530-P	HP540-P	HP545-P		
Schneidkantenausführung	1W	1W	1R	1R		
CCHT09	a_p max. [mm]					
Radius	CCHT09T304E02L-...-...	0,1 - 2,0 *	30909374	30909375	30907411	30909351
	CCHT09T304E02R-...-...	0,1 - 2,0	30909376	30909377	30909352	30909353
	CCHT09T308E02L-...-...	0,1 - 2,0	30909378	30909379	30909354	30909355
	CCHT09T308E02R-...-...	0,1 - 2,0	30909380	30909381	30909356	30909357

* Abhängig vom Passlager.

Auch für Sonderschneiden möglich.

SCHT | Mischbearbeitung

Radial-Wendeschneidplatten, vierschneidig, Mischbearbeitung



mit Radius,
linke Ausführung



mit Radius,
rechte Ausführung

Werkstoff	N + K		N + P			
	GJL verschleißfest	GJS zäh	unlegiert verschleißfest	legiert zäh		
Substrat	Hartmetall		Hartmetall			
Beschichtung	PVD		PVD			
Schneidstoffsorte	HP525-P	HP530-P	HP540-P	HP545-P		
Schneidkantenausführung	2W	2W	2R	2R		
SCHT09	a_p max. [mm]					
Radius	SCHT09T304E02L-...-...	0,1 - 2,0	30909366	30909367	30909345	30909346
	SCHT09T304E02R-...-...	0,1 - 2,0	30909368	30909369	30909347	30909348
	SCHT09T308E02L-...-...	0,1 - 2,0	30909370	30909371	30909349	30909350
	SCHT09T308E02R-...-...	0,1 - 2,0	30909372	30909373	30903215	30907589

CTNQ

Tangential-Wendeschneidplatten, vierschneidig, ohne Bogenschliff



Werkstoff	P			M ₁	
	unlegiert verschleißfest			legiert zäh	
Substrat	Hartmetall				Hartmetall
Beschichtung	CVD	PVD		CVD	
Schneidstoffsorte	HC740	HP945	HP950	HC750	

Schneidkantenausführung		H02	H02	H02	A32	
CTNQ ab ø 41 mm		a _p max. [mm]				
Schruppen	CTNQ090508...L-...	1,5 - 3,0	30933846	30933848	30933849	30950088
		1,5 - 4,0				
	CTNQ090508...R-...	1,5 - 3,0	30933850	30933851	30950091	30950092
		1,5 - 4,0				
	CTNQ090512...L-...	1,5 - 3,0	30933852	30933854	30933855	30950094
		1,5 - 4,0				
	CTNQ090512...R-...	1,5 - 3,0	30933856	30933857	30950097	30950099
		1,5 - 4,0				
	CTNQ ab ø 54 mm					
	CTNQ120608...L-...	1,5 - 3,0	30933864	30933866	30933867	
		1,5 - 5,0				
	CTNQ120612...L-...	1,5 - 3,0	30933868	30933869	30980913	
1,5 - 5,0						

Schneidkantenausführung		A32	A32	A32	A32	
CTNQ ab ø 41 mm		a _p max. [mm]				
Mittlere Bearbeitung	CTNQ090508...L-...	0,5 - 2,0	30933892	30933894	30933895	30950088
	CTNQ090508...R-...	0,5 - 2,0	30933896	30933897	30950112	30950092
	CTNQ090512...L-...	0,5 - 2,0	30933898	30933900	30933901	30950094
	CTNQ090512...R-...	0,5 - 2,0	30933902	30933903	30950118	30950099

M₁ Rostfreier StahlM₂ Hitzebeständiger Stahlguss (Turboladerwerkstoffe)Angegebene a_p-Bereiche sind Empfehlungen und können abhängig vom bearbeiteten Werkstoff variieren.

M ₂			K			
austenitisch ← verschleißfest	ferritisch → zäh		GJL ← verschleißfest	GJS → zäh	GJL ← verschleißfest	GJS → zäh
Hartmetall			Hartmetall			
CVD		PVD	CVD		PVD	
HC740	HC750	HP945	HC725	HC740	HP930	HP945
H02	H02	H02	H02	H02	H02	H02
30933846	30980873	30933848				
			30933926	30933846	30933929	30933848
30933850	30980900	30933851				
			30933931	30933850	30933934	30933851
30933852	30980902	30933854				
			30933936	30933852	30933939	30933854
30933856	30980905	30933857				
			30933941	30933856	30933944	30933857
30933864	30980907	30933866				
			30933956	30933864	30933959	30933866
30933868	30980911	30933869				
			30933961	30933868	30933964	30933869
A32	A32	A32	A32	A32	A32	A32
30933892	30950088	30933894	30934005	30933892	30934008	30933894
30933896	30950092	30933897	30934010	30933896	30934013	30933897
30933898	30950094	30933900	30934015	30933898	30934018	30933900
30933902	30950099	30933903	30934020	30933902	30934023	30933903

CTGQ

Tangential-Wendeschneidplatten, vierschneidig, Grundbohrung, mit Bogenschliff



Werkstoff	P				K			
	← unlegiert verschleißfest	legiert zäh	← unlegiert verschleißfest	legiert zäh	GJL ← verschleißfest	GJS zäh	GJL ← verschleißfest	GJS zäh
Substrat	Hartmetall				Hartmetall			
Beschichtung	CVD		PVD		CVD		PVD	
Schneidstoffsorte	HC740	HC745	HP945	HP950	HC725	HC740	HP930	HP945

Schneidkantenausführung	H02	H02	H02	H02	H02	H02	H02	H02
-------------------------	-----	-----	-----	-----	-----	-----	-----	-----

CTGQ ø 65 mm		a_p max. [mm]								
Schruppen	CTGQ090504...L00B041-...	1,5 - 3,0	31173955	31173956	31173957	31173958				
		1,5 - 4,0					31173959	31173955	31173980	31173957
	CTGQ090508...L00B041-...	1,5 - 3,0	31173981	31173982	31173983	31173984				
		1,5 - 4,0					31173985	31173981	31173986	31173983
	CTGQ090512...L00B041-...	1,5 - 3,0	31173987	31184714	31173988	31184715				
		1,5 - 4,0					31173989	31173987	31173990	31173988
	CTGQ ø 78 mm		a_p max. [mm]							
	Schruppen	CTGQ120604...L00B081-...	1,5 - 3,0	31184725	31184726	31184728	31184729			
1,5 - 5,0							31184724	31184725	31184727	31184728
CTGQ120608...L00B081-...		1,5 - 3,0	31173995	31173996	31173997	31173998				
		1,5 - 5,0					31173999	31173995	31174000	31173997
CTGQ120612...L00B081-...		1,5 - 3,0	31184731	31184732	31184734	31184735				
		1,5 - 5,0					31184730	31184731	31184733	31184734

Schneidkantenausführung	A32	A32	A32	A32	A32	A32	A32	A32
-------------------------	-----	-----	-----	-----	-----	-----	-----	-----

CTGQ ø 65 mm		a_p max. [mm]								
Mittlere Bearbeitung	CTGQ090504...L00B041-...	0,5 - 2,0	31174001	31184716	31174002	31184717	31174003	31174001	31174004	31174002
	CTGQ090508...L00B041-...	0,5 - 2,0	31174005	31184718	31174006	31184719	31174007	31174005	31174008	31174006
	CTGQ090512...L00B041-...	0,5 - 2,0	31174009	31184720	31174010	31184721	31174011	31174009	31174012	31174010

Angegebene a_p -Bereiche sind Empfehlungen und können abhängig vom bearbeiteten Werkstoff variieren.

CTGQ

Tangential-Wendeschneidplatten, vierschneidig, Durchgangsbohrung, mit Bogenschliff



Werkstoff	P				K					
	← unlegiert verschleißfest	legiert → zäh	← unlegiert verschleißfest	legiert → zäh	← GJL verschleißfest	GJS → zäh	← GJL verschleißfest	GJS → zäh		
Substrat	Hartmetall				Hartmetall					
Beschichtung	CVD		PVD		CVD		PVD			
Schneidstoffsorte	HC740	HC745	HP945	HP950	HC725	HC740	HP930	HP945		
Schneidkantenausführung	H02	H02	H02	H02	H02	H02	H02	H02		
CTGQ ab ϕ 65 mm a_p max. [mm]										
Schruppen	CTGQ090508...L10B041-...	1,5 - 3,0	31174013	31174014	31174015	31174016				
		1,5 - 4,0					31174017	31174013	31174018	31174015
	CTGQ ab ϕ 78 mm									
	CTGQ120608...L10B081-...	1,5 - 3,0	31174019	31174020	31174021	31174022				
1,5 - 5,0						31174023	31174019	31174024	31174021	
Schneidkantenausführung	A32	A32	A32	A32	A32	A32	A32	A32		
CTGQ ab ϕ 65 mm a_p max. [mm]										
Mittlere Bearbeitung	CTGQ090508...L10B041-...	0,5 - 2,0	31174029	31184722	31174031	31184723	31174030	31174029	31174032	31174031

CTHQ

Tangential-Wendeschneidplatten, vierschneidig, ohne Bogenschliff

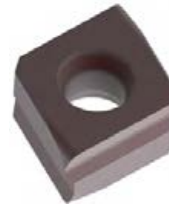

linke Ausführung



rechte Ausführung

Werkstoff	P		M ₁	M ₂		M ₂
				← unlegiert verschleißfest	legiert → zäh	
Substrat	Hartmetall		Hartmetall	Hartmetall		Hartmetall
Beschichtung	CVD	PVD	CVD	CVD		PVD
Schneidstoffsorte	HC740	HP945	HC750	HC740	HC750	HP945

Schneidkantenausführung							
CTHQ ab ø 28 mm		a _p max. [mm]					
Schruppen	CTHQ060408...L-...	1,5 - 2,5					
	CTHQ060408...R-...	1,5 - 2,5					
	Schneidkantenausführung			A32	H02	H02	H02
	CTHQ ab ø 41 mm		a _p max. [mm]				
	CTHQ090508...L-...	1,5 - 3,0		30950084	30980629	30980631	30980632
		1,5 - 4,0					
	CTHQ090508...R-...	1,5 - 3,0		30950086	30980712	30980714	30980751
		1,5 - 4,0					
	CTHQ ab ø 54 mm						
	CTHQ120608...L-...	1,5 - 3,0			30980759	30980765	30980766
1,5 - 5,0							
CTHQ120608...R-...	1,5 - 3,0			30980784	30980786	30980787	
	1,5 - 5,0						

Schneidkantenausführung		A32	A32		A32	A32	A32
CTHQ ab ø 28 mm		a _p max. [mm]					
Mittlere Bearbeitung	CTHQ060404...R-...	0,5 - 2,0					
	CTHQ ab ø 41 mm						
	CTHQ090504...L-...	0,5 - 2,0	30933878	30933880		30933878	30980967
	CTHQ090504...R-...	0,5 - 2,0				30980968	
	CTHQ090508...L-...	0,5 - 2,0	30813598	30933885		30813598	30950084
	CTHQ090508...R-...	0,5 - 2,0				30950086	
	CTHQ ab ø 54 mm						
	CTHQ120604...L-...	0,5 - 2,0	30933904			30933904	
CTHQ120604...R-...	0,5 - 2,0	30980051			30980051		

M₁ Rostfreier Stahl

M₂ Hitzebeständiger Stahlguss (Turboladerwerkstoffe)

Angegebene a_p-Bereiche sind Empfehlungen und können abhängig vom bearbeiteten Werkstoff variieren.



Bestückte Varianten,
einschneidig:

A79, A80

K				N		
GJL ← verschleißfest		GJS zäh	GJL ← verschleißfest	GJS zäh		
Hartmetall				Hartmetall		PKD
CVD		PVD		-	PVD	-
HC725	HC740	HP930	HP945	HU616	HP615	PU617
H32	H32	H32	H32			
30933907	30980615	30933910	30980618			
30933912	30980621		30980625			
H02	H02	H02	H02			A80
30921024	30980629	30933917	30980632			30492720
30921023	30980712	30933923	30980751			30515656
30933946	30980759	30933949	30980766			
30933951	30980784	30933954	30980787			
A32	A32	A32	A32	A30	A30	A80
30679873	30942364		30942366	30477914	31010211	
30679874	30933878	30933979	30933880	30492760	31010211	30492764
30679875		30942374		30492770		30515411
30724676	30813598	30933994	30933885	31186236	30610917	
30789885		30942382		31264530	31203830	
30789886	30933904	30934028		30477929		
30789887	30980051	30980054		30477930		

CTHQ

Tangential-Wendeschneidplatten, vierschneidig, Grundbohrung, mit Bogenschliff

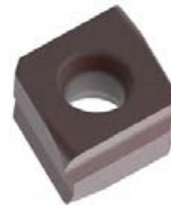

Werkstoff	P				M ₂	
	← unlegiert verschleißfest	legiert zäh	← unlegiert verschleißfest	legiert zäh		
Substrat	Hartmetall				Hartmetall	
Beschichtung	CVD		PVD		CVD	
Schneidstoffsorte	HC740	HC745	HP945	HP950	HC750	

Schneidkantenausführung		A53	A53	A53	A53	A32		
CTHQ ab \varnothing 65 mm		a_p max. [mm]						
Schruppen	CTHQ090508...L00B041-...	1,5 - 3,0	30933714	30933715	30933716	30933717	30933718	
		1,5 - 4,0						
	CTHQ090512...L00B041-...	1,5 - 3,0	30950047					
		1,5 - 4,0						
	CTHQ ab \varnothing 78 mm							
	CTHQ120608...L00B081-...	1,5 - 3,0	30933733	30933734				
1,5 - 5,0								
CTHQ120612...L00B081-...	1,5 - 3,0	30950048						
	1,5 - 5,0							

Schneidkantenausführung		A32		A32			
CTHQ ab \varnothing 40 mm		a_p max. [mm]					
Mittlere Bearbeitung	CTHQ060404...L00B021-...	0,5 - 2,0					
		0,5 - 2,0					
	CTHQ ab \varnothing 65 mm						
	CTHQ090504...L00B041-...	0,5 - 2,0	30950080		30988741		
	CTHQ090508...L00B041-...	0,5 - 2,0	30988732		30988742		
	CTHQ ab \varnothing 78 mm						
CTHQ120604...L00B081-...	0,5 - 2,0						
	CTHQ120608...L00B081-...	0,5 - 2,0	30988734		30988744		

M₂ Hitzebeständiger Stahlguss (Turboladerwerkstoffe)

Angegebene a_p -Bereiche sind Empfehlungen und können abhängig vom bearbeiteten Werkstoff variieren.



Bestückte Variante,
einschneidig:

A79, A80

K				N	
GJL ← verschleißfest		GJS → zäh		GJL ← verschleißfest	
Hartmetall				Hartmetall	
CVD		PVD		-	
HC725	HC740	HP930	HP945	HU616	PKD
H02				A80	
30933721	30988707	30933724	30988736		30492584
30933727	30988708	30933730	30988737		
30933735	30988709	30933738	30988738		
	30988730		30988739		
A32				A30	
A32				A80	
30679863	30988748	30933807	30988753	30477915	30492616
30679858	30950080	30933756	30988741	30328643	
30679859	30988732	30933765	30988742	30307194	30492584
30789881	31322355	31322356	31322357	30477928	
30789882	30988734	30933777	30988744	30477931	31213527

CTHQ

Tangential-Wendeschneidplatten, vierschneidig, Durchgangsbohrung, mit Bogenschliff



Werkstoff	P				M ₂		
	← unlegiert verschleißfest	legiert zäh	← unlegiert verschleißfest	legiert zäh			
Substrat	Hartmetall				Hartmetall		
Beschichtung	CVD		PVD		CVD		
Schneidstoffsorte	HC740	HC745	HP945	HP950	HC750		
Schneidkantenausführung	A53	A53	A53	A53	A32		
CTHQ ab ø 65 mm	a _p max. [mm]						
Schruppen	CTHQ090508...L10B041-...	1,5 - 3,0	30933783	30933784	30933785	30933786	30933787
		1,5 - 4,0					
	CTHQ ab ø 78 mm						
Schruppen	CTHQ120608...L10B081-...	1,5 - 3,0	30950082				
		1,5 - 5,0					
Schneidkantenausführung	A32		A32				
CTHQ ab ø 40 mm	a _p max. [mm]						
Mittlere Bearbeitung	CTHQ060408...L10B021-...	0,5 - 2,0					
	CTHQ ab ø 65 mm						
	CTHQ090508...L10B041-...	0,5 - 2,0	30988749		30988755		
	CTHQ ab ø 78 mm						
	CTHQ120608...L10B081-...	0,5 - 2,0	30988750		30988756		

M₂ Hitzebeständiger Stahlguss (Turboladerwerkstoffe)

Angegebene a_p-Bereiche sind Empfehlungen und können abhängig vom bearbeiteten Werkstoff variieren.



Bestückte Varianten,
einschneidig:

A79, A80

K				N	
GJL ← verschleißfest		GJS → zäh	GJL ← verschleißfest	GJS → zäh	
Hartmetall				Hartmetall	PKD
CVD		PVD		-	-
HC725	HC740	HP930	HP945	HU616	PU617
H02	H02	H02	H02		A80
30933790	30988746	30933793	30988751		30492657
30933796	30988747	30933799	30988752		
A32	A32	A32	A32	A30	A80
30679863	30988748	30933807	30988753	30477916	
30679865	30988749	30933825	30988755	30307197	30492657
	30988750		30988756	30477932	

FTNQ

Tangential-Wendeschneidplatten, vierschneidig, ohne Bogenschliff



Werkstoff	P		M ₁	M ₂	
				austenitisch verschleißfest	ferritisch zäh
Substrat	Hartmetall		Hartmetall	Hartmetall	
Beschichtung	CVD	PVD	CVD	CVD	
Schneidstoffsorte	HC740	HP945	HC750	HC740	HC750

Schneidkantenausführung	H02	H02	A32	H02	H02
-------------------------	-----	-----	-----	-----	-----

FTNQ ab ø 30 mm a_p max. [mm]

Schruppen	FTNQ090508...L-...	1,5 - 3,0	30934169	30934170	30934171	30934169	30980508	
		1,5 - 4,0						
	FTNQ ab ø 40 mm							
	FTNQ120608...L-...	1,5 - 3,0	30934188	30934189		30934188	30980523	
		1,5 - 5,0						
	FTNQ120608...R-...	1,5 - 3,0	30934196	30934197		30934196		
		1,5 - 5,0						

Schneidkantenausführung	A32	A32		A32	A32
-------------------------	-----	-----	--	-----	-----

FTNQ ab ø 30 mm a_p max. [mm]

Mittlere Bearbeitung	FTNQ090508...L-...	0,5 - 2,0	30934222	30934223		30934222	30934171
		0,5 - 2,0					

M₁ Rostfreier StahlM₂ Hitzebeständiger Stahlguss (Turboladerwerkstoffe)Angegebene a_p-Bereiche sind Empfehlungen und können abhängig vom bearbeiteten Werkstoff variieren.

	M₂	K			
		GJL ← verschleißfest		GJS → zäh	
	Hartmetall	Hartmetall			
	PVD	CVD		PVD	
	HP945	HC725	HC740	HP930	HP945
	H02	H02	H02	H02	H02
	30934170				
		30934173	30934169	30934175	30934170
	30934189				
		30934192	30934188	30934194	30934189
	30934197				
		30934198	30934196	30934200	30934197
	A32	A32	A32	A32	A32
	30934223				
		30934173	30934222	30934175	30934223

FTGQ

Tangential-Wendeschneidplatten, vierschneidig, Grundbohrung, mit Bogenschliff



Werkstoff	P				K			
	← unlegiert verschleißfest	legiert zäh	← unlegiert verschleißfest	legiert zäh	GJL verschleißfest	GJS zäh	GJL verschleißfest	GJS zäh
Substrat	Hartmetall				Hartmetall			
Beschichtung	CVD		PVD		CVD		PVD	
Schneidstoffsorte	HC740	HC745	HP945	HP950	HC725	HC740	HP930	HP945

Schneidkantenausführung		H02	H02	H02	H02	H02	H02	H02	H02	
FTGQ ab ø 30 mm		a_p max. [mm]								
Schruppen	FTGQ090504...L00B016-...	1,5 - 3,0	31174033	31174034	31174035	31174036				
		1,5 - 4,0					31174037	31174033	31174038	31174035
	FTGQ090508...L00B016-...	1,5 - 3,0	31174039	31174040	31174041	31174042				
		1,5 - 4,0					31174043	31174039	31174044	31174041
	FTGQ090512...L00B016-...	1,5 - 3,0	31184737	31184738	31184740	31184741				
		1,5 - 4,0					31184736	31184737	31184739	31184740
	FTGQ ab ø 40 mm									
	FTGQ120604...L00B021-...	1,5 - 3,0	31184755	31184756	31184758	31184759				
		1,5 - 5,0					31184754	31184755	31184757	31184758
	FTGQ120608...L00B021-...	1,5 - 3,0	31174045	31174046	31174047	31174048				
		1,5 - 5,0					31174049	31174045	31174050	31174047
	FTGQ120612...L00B021-...	1,5 - 3,0	31184761	31184762	31184764	31184765				
1,5 - 5,0						31184760	31184761	31184763	31184764	

Schneidkantenausführung		A32	A32	A32	A32	A32	A32	A32	A32	
FTGQ ab ø 30 mm		a_p max. [mm]								
Mittlere Bearbeitung	FTGQ090504...L00B016-...	0,5 - 2,0	31174051	31184742	31174053	31184743	31174052	31174051	31174054	31174053
	FTGQ090508...L00B016-...	0,5 - 2,0	31174055	31184744	31174057	31184745	31174056	31174055	31174058	31174057
	FTGQ090512...L00B016-...	0,5 - 2,0	31184747	31184748	31184750	31184751	31184746	31184747	31184749	31184750

Angegebene a_p -Bereiche sind Empfehlungen und können abhängig vom bearbeiteten Werkstoff variieren.

FTGQ

Tangential-Wendeschneidplatten, vierschneidig, Durchgangsbohrung, mit Bogenschliff



Werkstoff	P				K					
	unlegiert verschleißfest	legiert zäh	unlegiert verschleißfest	legiert zäh	GJL verschleißfest	GJS zäh	GJL verschleißfest	GJS zäh		
Substrat	Hartmetall				Hartmetall					
Beschichtung	CVD		PVD		CVD		PVD			
Schneidstoffsorte	HC740	HC745	HP945	HP950	HC725	HC740	HP930	HP945		
Schneidkantenausführung	H02	H02	H02	H02	H02	H02	H02	H02		
FTGQ ab \varnothing 30 mm	a_p max. [mm]									
Schruppen	FTGQ090508...L10B016-...	1,5 - 3,0	31174059	31174060	31174061	31174062				
		1,5 - 4,0					31174063	31174059	31174065	31174061
	FTGQ ab \varnothing 40 mm									
	FTGQ120608...L10B021-...	1,5 - 3,0	31174066	31174067	31174068	31174069				
1,5 - 5,0						31174070	31174066	31174071	31174068	
Schneidkantenausführung	A32	A32	A32	A32	A32	A32	A32	A32		
FTGQ ab \varnothing 30 mm	a_p max. [mm]									
Mittlere Bearbeitung	FTGQ090508...L10B016-...	0,5 - 2,0	31174076	31184752	31174078	31184753	31174077	31174076	31174079	31174078

Angegebene a_p -Bereiche sind Empfehlungen und können abhängig vom bearbeiteten Werkstoff variieren.

FTHQ

Tangential-Wendeschneidplatten, vierschneidig, ohne Bogenschliff



Werkstoff	P		M ₁			austenitisch verschleißfest		ferritisch zäh	
	Hartmetall		Hartmetall						
Substrat	CVD		PVD		CVD		PVD		
Beschichtung	HC740		HP945		HC750		HC740		HC750

Schneidkantenausführung		A53	A53	A32	H02	H02		
FTHQ ab ø 30 mm		a _p max. [mm]						
Schruppen	FTHQ090508...L-...	1,5 - 3,0	30980167	30934159	30934160	30912756	30980484	
		1,5 - 4,0						
	FTHQ090508...R-...	1,5 - 3,0	30934166	30934167	30950130	30980488		
		1,5 - 4,0						
	FTHQ ab ø 40 mm							
	FTHQ120608...L-...	1,5 - 3,0	30934177	30934178	30934179	30980491	30980493	
1,5 - 5,0								
FTHQ120608...R-...	1,5 - 3,0	30934185	30934186	30950135	30980501			
	1,5 - 5,0							

Schneidkantenausführung		A32	A32	A32	A32		
FTHQ ab ø 22 mm		a _p max. [mm]					
Mittlere Bearbeitung	FTHQ060404...L-...	0,5 - 1,5					
	FTHQ060404...R-...	0,5 - 1,5					
	FTHQ060408...L-...	0,5 - 1,5					
	FTHQ060408...R-...	0,5 - 1,5					
	FTHQ ab ø 30 mm						
	FTHQ090504...L-...	0,5 - 2,0					
	FTHQ090504...R-...	0,5 - 2,0					
	FTHQ090508...L-...	0,5 - 2,0	30934214	30934215	30934214	30934160	
	FTHQ090508...R-...	0,5 - 2,0				30950130	
	FTHQ ab ø 40 mm						
	FTHQ120604...L-...	0,5 - 2,0					
	FTHQ120604...R-...	0,5 - 2,0					
	FTHQ120608...L-...	0,5 - 2,0	30934231	30934232	30934231	30934179	
	FTHQ120608...R-...	0,5 - 2,0				30950135	

M₁ Rostfreier StahlM₂ Hitzebeständiger Stahlguss (Turboladerwerkstoffe)Angegebene a_p-Bereiche sind Empfehlungen und können abhängig vom bearbeiteten Werkstoff variieren.

FTHQ

Tangential-Wendeschneidplatten, vierschneidig, Grundbohrung, mit Bogenschliff

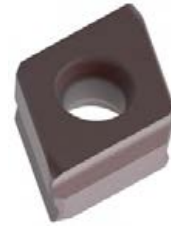

Werkstoff	P		M	
	unlegiert ← verschleißfest	legiert → zäh	unlegiert ← verschleißfest	legiert → zäh
Substrat	Hartmetall		Hartmetall	
Beschichtung	CVD		PVD	
Schneidstoffsorte	HC740		HP945	

Schneidkantenausführung		A53	A53	A32	
FTHQ ab \varnothing 30 mm		a_p max. [mm]			
Schruppen	FTHQ090508...L00B016-...	1,5 - 3,0	30980181	30934058	
		1,5 - 4,0			
	FTHQ090512...L00B016-...	1,5 - 3,0	30934075	30934076	
		1,5 - 4,0			
	FTHQ ab \varnothing 40 mm				
	FTHQ120608...L00B021-...	1,5 - 3,0	30934081	30934082	
	1,5 - 5,0				
FTHQ120612...L00B021-...	1,5 - 3,0	30934087	30934088		
	1,5 - 5,0				

Schneidkantenausführung		A32			
FTHQ ab \varnothing 22 mm		a_p max. [mm]			
Mittlere Bearbeitung	FTHQ060404...L00B012-...	0,5 - 1,5			
	FTHQ060408...L00B012-...	0,5 - 1,5			
	FTHQ ab \varnothing 30 mm				
	FTHQ090504...L00B016-...	0,5 - 2,0	30950123		
	FTHQ090508...L00B016-...	0,5 - 2,0	30901249		
	FTHQ ab \varnothing 40 mm				
	FTHQ120604...L00B021-...	0,5 - 2,0			
	FTHQ120608...L00B021-...	0,5 - 2,0	30934113		
FTHQ120612...L00B021-...	0,5 - 2,0				



Bestückte Variante,
einschneidig:

A79, A80

K		K		N		
GJL ← verschleißfest		GJS → zäh	GJL ← verschleißfest		GJS → zäh	
Hartmetall CVD		Hartmetall PVD		Hartmetall	PKD	
HC725	HC740	HP930	HP945	-	-	
				HU616	PU617	
H02	H02	H02	H02			A80
30934071	30934057	30934073	30988760			30492784
30934077	30988757	30934079	30988761			
30934083	30988758	30934085	30988762			
30934089	30988759	30934091	30988763			
A32	A32	A32	A32	A30	A79	A80
30679879	30950121	30934095	30988764	30477935		
30679880	30950122	30934099	30988765	30477936	30492816	
30679881	30950123	30934103	30988766	30477942		
30679882	30901249	30934111	30934106	30478043		30492784
30934115	30934113	30934118	30934114	30477950		
				30477952		
				30492842		

FTHQ

Tangential-Wendeschneidplatten, vierschneidig, Durchgangsbohrung, mit Bogenschliff

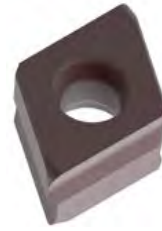

Werkstoff	P		M	K		
	Hartmetall		Hartmetall	Hartmetall		
Substrat	CVD		PVD	CVD		
Beschichtung	HC740		HP945	HC750	HC725	HC740
Schneidstoffsorte	A53		A53	A32	H02	H02
Schneidkantenausführung	FTHQ ab ϕ 30 mm		FTHQ ab ϕ 40 mm		FTHQ ab ϕ 22 mm	
a_p max. [mm]						
Schruppen	FTHQ090508...L10B016-...	1,5 - 3,0	30934120	30934121	30934122	
		1,5 - 4,0				
	FTHQ120608...L10B021-...	1,5 - 3,0	30934128	30934129		
		1,5 - 5,0				
Mittlere Bearbeitung	FTHQ060408...L10B012-...	0,5 - 1,5				
	FTHQ090508...L10B016-...	0,5 - 2,0	30942389	30942390		
FTHQ120608...L10B021-...	0,5 - 2,0	30942391	30942392			

Angegebene a_p -Bereiche sind Empfehlungen und können abhängig vom bearbeiteten Werkstoff variieren.



Bestückte Variante,
einschneidig:

A79, A80

<div style="background-color: #f4a460; padding: 5px;"> K GJL verschleißfest ← </div>			<div style="background-color: #4db6ac; padding: 5px;"> N GJS zäh → </div>			
	Hartmetall			Hartmetall	PKD	
	PVD			-	-	
	HP930	HP945		HU616	PU617	
	H02	H02			A80	
	30934126	30988769			30492850	
	30934132	30988770			30668155	
	A32	A32	A30	A79	A80	
	30942394	30942388	30477937	30492868		
	30942397	30942390	30477944		30492850	
	30942400	30942392	30477953		30668155	

STHD - STHE

Tangential-Wendeschneidplatten, vierschneidig, Fasen, neutrale Ausführung



Bestückte Variante,
einschneidig:

D80

Werkstoff	M ₂	K		N	
Substrat	Hartmetall	Hartmetall		Hartmetall	PKD
Beschichtung	PVD	CVD	PVD	-	-
Schneidstoffsorte	HP930	HC725	HP930	HU616	PU617



Schneidkantenausführung		D02	D02	D02	D00	D80	
STH_06		a _p max. [mm]					
Fasen	STHD060300...N-...	0,1 - 4,2	30950141	30774242	30950141	30213884	30493003
	STHE060300...N-...	0,1 - 4,2	30950142	30789899	30950142	30228119	30370122
	STH_09						
	STHD09T300...N-...	0,1 - 6,3	30950143	30631370	30950143	30215016	30493005
	STHE09T300...N-...	0,1 - 6,3	30950144	30631351	30950144	30257365	30493006

M₂ Hitzebeständiger Stahlguss (Turboladerwerkstoffe)

Angegebene a_p-Bereiche sind Empfehlungen und können abhängig vom bearbeiteten Werkstoff variieren.

Notizen





Zubehör für Tangential-Wendeschneidplatten

WSP	WSP-Größe	Spannschraube					Schraubendreher
		Abmessung [Mxl]	Bezeichnung	Anzugsdrehmoment [Nm]	Torxgröße	Bestell-Nr.	Bestell-Nr.
CT... 	0604	M2.5 x 8.7	MN659 M2.5x8.7-TX8-IP	1	TX8-IP	30533284	30414760
	0905	M3.5 x 11	MN659 M3.5x11-TX10-IP	2,8	TX10-IP	10105079	30414763
	1206	M5 x 14	MN659 M5x14-TX20-IP	7,5	TX20-IP	10006485	30414766
FT... 	0604	M2.5 x 8.7	MN659 M2.5x8.7-TX8-IP	1	TX8-IP	30533284	30414760
	0905	M3.5 x 11	MN659 M3.5x11-TX10-IP	2,8	TX10-IP	10105079	30414763
	1206	M5x14	MN659 M5x14-TX20-IP	7,5	TX20-IP	10006485	30414766
ST... 	0603	M2.5 x 6	MN659 M2.5x6-TX8-IP	1	TX8-IP	10105073	30414760
	09T3	M3.5x9	MN659 M3.5x9-TX15-IP	2,8	TX15-IP	10105078	30414764

Hochtemperatur-Schraubenpaste

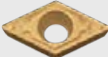
Keramik-Paste/ verschleißbare PE-Tube 30 g	30861389
--	----------

Zubehör für Radial-Wendeschneidplatten

WSP	WSP-Größe	Spannschraube					Schraubendreher
		Abmessung [Mxl]	Bezeichnung	Anzugsdrehmoment [Nm]	Torxgröße	Bestell-Nr.	Bestell-Nr.
CC... 	0602	M2.5 x 6	MN659 M2.5x6-TX8-IP	1	TX8-IP	10105073	30414760
	09T3	M3.5 x 9	MN659 M3.5x9-TX15-IP	2,8	TX15-IP	10105078	30414764
	1204	M5 x 11	MN659 M5x11-TX20-IP	7,5	TX20-IP	10105082	30414766
DC... 	0702	M2.5 x 6	MN659 M2.5x6-TX8-IP	1	TX8-IP	10105073	30414760
	11T3	M3.5 x 9	MN659 M3.5x9-TX15-IP	2,8	TX15-IP	10105078	30414764
	1504	M5x11	MN659 M5x11-TX20-IP	7,5	TX20-IP	10105082	30414766
SP... 	0603	M2.5 x 6	MN659 M2.5x6-TX8-IP	1	TX8-IP	10105073	30414760
TC... 	06T1	M2 x 4.95	MN659 M2x4.95-TX6-IP	0,5	TX6-IP	10002712	30414758
	0902	M2.2 x 5.5	MN659 M2.2x5.5-TX7-IP	0,8	TX7-IP	10105070	30414759
	1102	M2.5 x 6	MN659 MN2.5x6-TX8-IP	1	TX8-IP	10105073	30414760
	16T3	M3.5 x 9	MN659 M3.5x9-TX15-IP	2,8	TX15-IP	10105078	30414764
	2204	M5x11	MN659 M5x11-TX20-IP	7,5	TX20-IP	10105082	30414766
SC... 	09T3	M3.5 x 9	MN659 M3.5x9-TX15-IP	2,8	TX15-IP	10105078	30414764
	1204	M5 x 11	MN659 M5x11-TX20-IP	7,5	TX20-IP	10105082	30414766
VB-/VC... 	1103	M2.5 x 6	MN659 MN2.5x6-TX8-IP	1	TX8-IP	10105073	30414760
	1604	M3.5 x 9	MN659 M3.5x9-TX15-IP	2,8	TX15-IP	10105078	30414764

Schnittwertempfehlung für Aufbohrwerkzeuge mit Wendeschneidplatten (1/2)

Schnittgeschwindigkeit [m/min]

MZG*	Werkstoff		Festigkeit/Härte [N/mm ²] [HRC]	Cermet		PcBN	
				CVD-beschichtet	PVD-beschichtet	unbeschichtet	
				CC112	CP872	FU430	HC725
P	P1	P1.1	Bau-, Automaten-, Einsatz- und Vergütungsstähle, unlegiert	< 700	160-600	200-300	
		P1.2	Bau-, Automaten-, Einsatz- und Vergütungsstähle, unlegiert	< 1.200	160-500		
	P2	P2.1	Nitrier-, Einsatz- und Vergütungsstähle, legiert	< 900	160-600	120-220	
		P2.2	Nitrier-, Einsatz- und Vergütungsstähle, legiert	< 1.400	140-400		
	P3	P3.1	Werkzeug-, Wälzlager-, Feder- und Schnellarbeitsstähle**	< 800	160-600	120-220	
		P3.2	Werkzeug-, Wälzlager-, Feder- und Schnellarbeitsstähle**	< 1.000	140-400		
		P3.3	Werkzeug-, Wälzlager-, Feder- und Schnellarbeitsstähle**	< 1.500			
	P4	P4.1	Werkzeug-, Wälzlager-, Feder- und Schnellarbeitsstähle**		140-400		
P5	P5.1	Rostfreie Stähle, ferritisch und martensitisch		140-400			
P6	P6.1	Stahlguss		140-400			
M	M1	M1.1	Rostfreier Stahlguss, ferritisch und martensitisch	< 700	100-500		
		M1.2	Rostfreie Stähle, ferritisch/austenitisch (Duplex)	< 1.000	100-450		
	M2	M2.1	Rostfreier Stahlguss, austenitisch	< 700	100-500		
	M3	M3.1	Rostfreier Stahlguss, ferritisch/austenitisch (Duplex)	< 1.000	100-450		
K	K1	K1.1	Gusseisen mit Lamellengraphit (Grauguss), GJL	< 300		400-1.000	140-300
		K2.1	Gusseisen mit Kugelgraphit, GJS	< 500		350-800	120-260
	K2	K2.2	Gusseisen mit Kugelgraphit, GJS	≤ 800			120-220
		K2.3	Gusseisen mit Kugelgraphit, GJS	> 800			80-140
	K3	K3.1	Gusseisen mit Vermiculargraphit, GJV; Temperguss, GJM	< 500			80-130
		K3.2	Gusseisen mit Vermiculargraphit, GJV; Temperguss, GJM	> 500			80-120
N	N1	N1.1	Aluminium, unlegiert und legiert <3 % Si				
		N1.2	Aluminium, legiert ≤ 7 % Si				
		N1.3	Aluminium, legiert > 7-12 % Si				
		N1.4	Aluminium, legiert > 12 % Si				
	N2	N2.1	Kupfer, unlegiert und niedriglegiert	< 300			
		N2.2	Kupfer, legiert	> 300			
		N2.3	Messing, Bronze, Rotguss	< 1.200			
	N3	N3.1	Graphit, > 8 µm	< 1.200			
		N3.2	Graphit, ≤ 8 µm				
	N4	N4.1	Kunststoff, Thermoplaste				
		N4.2	Kunststoff, Duroplaste				
		N4.3	Kunststoff, Schaumstoffe				
	K+K	K1.1, K1.2	Mischbearbeitung von Gusseisen (GJL und GJS)				
	K+P	K1.1, Sinter	Mischbearbeitung von Gusseisen und Sinterstahl				
N+K	N1.2, K1.1	Mischbearbeitung von Aluminium und Gusseisen (GJL)					
	N1.2, K1.2	Mischbearbeitung von Aluminium und Gusseisen (GJS)					
N+P	N1.2, Sinter	Mischbearbeitung von Aluminium und Sinterstahl					

* MAPAL Zerspanungsgruppen

** Wenn die Legierungsbestandteile Cr, Mo, Ni, V, W in Summe > 8 %, dann die nächst höhere MAPAL Zerspanungsgruppe wählen.

Schnittwertempfehlung für Aufbohrwerkzeuge mit Wendeschneidplatten (2/2)

Schnittgeschwindigkeit [m/min]

MZG*		Werkstoff	Festigkeit/Härte [N/mm ²] [HRC]	PVD-beschichtet				
				HP615	HP880	HP885	HP895	
P	P1	P1.1	Bau-, Automaten-, Einsatz- und Vergütungsstähle, unlegiert	< 700		100-220		100-220
		P1.2	Bau-, Automaten-, Einsatz- und Vergütungsstähle, unlegiert	< 1.200		100-220		100-220
	P2	P2.1	Nitrier-, Einsatz- und Vergütungsstähle, legiert	< 900		100-220		100-220
		P2.2	Nitrier-, Einsatz- und Vergütungsstähle, legiert	< 1.400		100-200		100-200
	P3	P3.1	Werkzeug-, Wälzlager-, Feder- und Schnellarbeitsstähle**	< 800		80-200		80-200
		P3.2	Werkzeug-, Wälzlager-, Feder- und Schnellarbeitsstähle**	< 1.000		80-200		80-200
		P3.3	Werkzeug-, Wälzlager-, Feder- und Schnellarbeitsstähle**	< 1500				
	P4	P4.1	Werkzeug-, Wälzlager-, Feder- und Schnellarbeitsstähle**			80-200		80-200
P5	P5.1	Rostfreie Stähle, ferritisch und martensitisch			80-200		80-200	
P6	P6.1	Stahlguss						
M	M1	M1.1	Rostfreier Stahlguss, ferritisch und martensitisch	< 700		150-220	100-180	150-220
		M1.2	Rostfreie Stähle, ferritisch/austenitisch (Duplex)	< 1.000		120-200	100-160	120-200
	M2	M2.1	Rostfreier Stahlguss, austenitisch	< 700		100-180	80-150	100-180
	M3	M3.1	Rostfreier Stahlguss, ferritisch/austenitisch (Duplex)	< 1.000		100-180	60-140	100-180
K	K1	K1.1	Gusseisen mit Lamellengraphit (Grauguss), GJL	< 300				
		K2.1	Gusseisen mit Kugelgraphit, GJS	< 500				
	K2	K2.2	Gusseisen mit Kugelgraphit, GJS	≤ 800				
		K2.3	Gusseisen mit Kugelgraphit, GJS	> 800				
	K3	K3.1	Gusseisen mit Vermiculargraphit, GJV; Temperguss, GJM	< 500				
		K3.2	Gusseisen mit Vermiculargraphit, GJV; Temperguss, GJM	> 500				
N	N1	N1.1	Aluminium, unlegiert und legiert <3 % Si		150-600			
		N1.2	Aluminium, legiert ≤ 7 % Si		100-500			
		N1.3	Aluminium, legiert > 7-12 % Si		100-400			
		N1.4	Aluminium, legiert > 12 % Si					
	N2	N2.1	Kupfer, unlegiert und niedriglegiert	< 300	100-350			
		N2.2	Kupfer, legiert	> 300	100-300			
		N2.3	Messing, Bronze, Rotguss	< 1.200	100-250			
	N3	N3.1	Graphit, > 8 µm	< 1.200				
		N3.2	Graphit, ≤ 8 µm					
	N4	N4.1	Kunststoff, Thermoplaste					
N4.2		Kunststoff, Duroplaste						
N4.3		Kunststoff, Schaumstoffe						
K1+K2	K1.1, K1.2	Mischbearbeitung von Gusseisen (GJL und GJS)						
K+P	K1.1, Sinter	Mischbearbeitung von Gusseisen und Sinterstahl						
N+K	N1.2, K1.1	Mischbearbeitung von Aluminium und Gusseisen (GJL)						
	N1.2, K1.2	Mischbearbeitung von Aluminium und Gusseisen (GJS)						
N+P	N1.2, Sinter	Mischbearbeitung von Aluminium und Sinterstahl						

* MAPAL Zerspanungsgruppen

** Wenn die Legierungsbestandteile Cr, Mo, Ni, V, W in Summe > 8 %, dann die nächst höhere MAPAL Zerspanungsgruppe wählen.

Hartmetall							PKD			
			PVD-beschichtet, Mischbearbeitung				unbeschichtet	unbeschichtet		
HP930	HP945	HP950	HP525-P	HP530-P	HP540-P	HP545-P	HU616	PU617	PU660	PU670
	100-180	100-160								
	100-180	100-160								
	100-180	100-160								
	80-150	80-150								
	100-180	100-160								
	80-130	90-130								
	80-130	90-130								
	80-130	90-130								
	80-130	90-130								
	70-120	70-120								
140-220	120-200									
120-200	120-180									
120-180	120-180									
80-140	80-120									
60-130	60-100									
60-120	60-100									
							150-500	450-2200	450-2200	410-1980
							100-450	400-1700	400-1700	360-1530
							100-400	350-1300	350-1300	320-1170
								200-800	200-800	180-720
							100-250	250-600	250-600	230-540
							100-220	200-600	200-600	180-540
							80-220	200-500	200-500	180-450
							120-480	300-600	300-600	270-540
							250-500	400-1000	400-1000	360-900
							250-500	400-1000	400-1000	360-900
			120-220	120-220	120-200					
				120-200	120-200	110-200				
			120-300	120-300	120-230					
			120-280	120-280	120-230					
				120-220	120-230	110-200				

Die angegebenen Arbeitswerte sind Richtwerte.
 Die für den jeweiligen Bearbeitungsfall optimalen Daten sollten im Versuch oder während der Bearbeitung ermittelt werden.

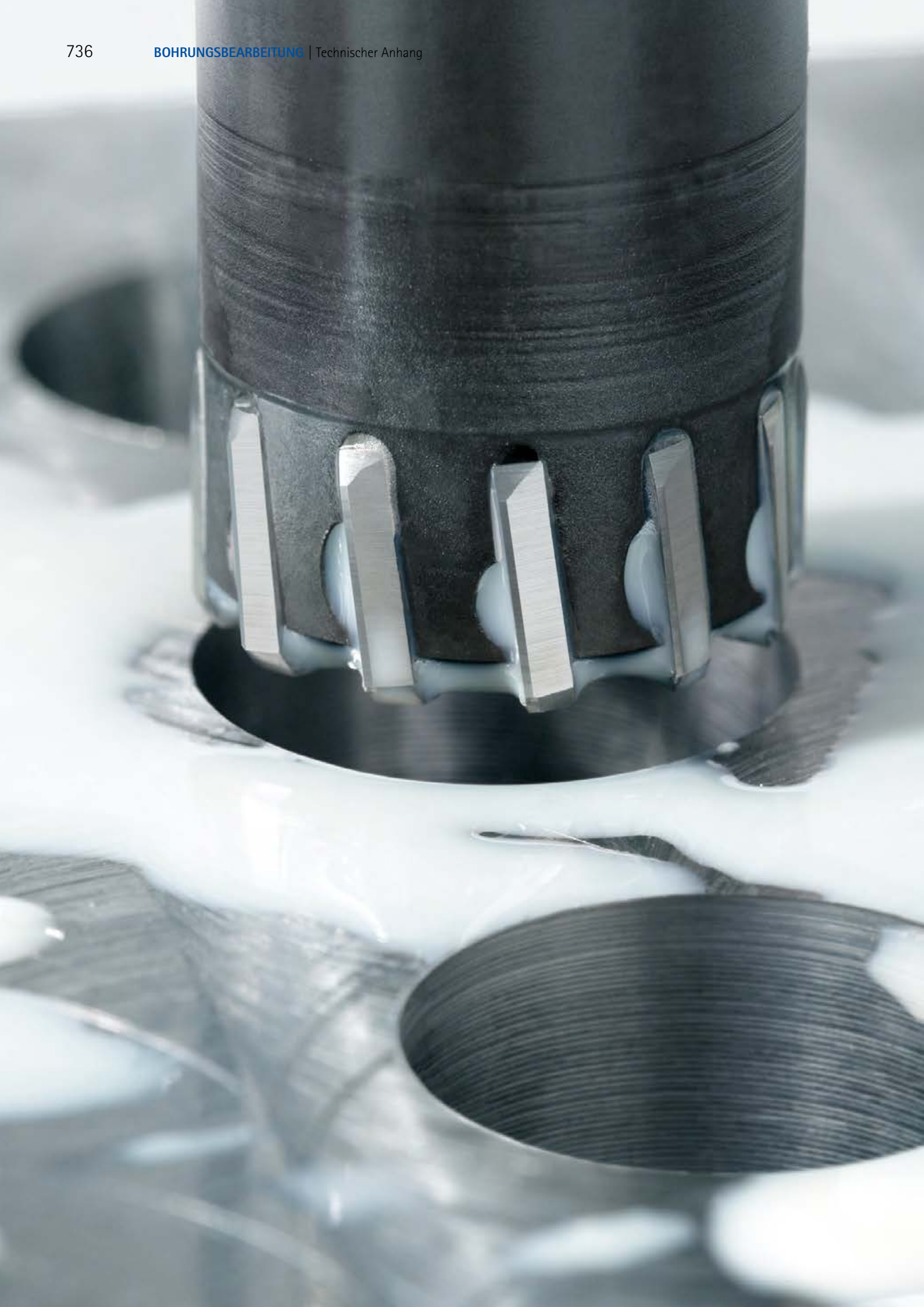

TECHNISCHER ANHANG

Hinweise zu Anwendung, Handhabung sowie Schnittdaten

TECHNISCHER ANHANG

Vollbohren

Anwendungshinweise	
Wechselkopfbohrer TTD-Tritan	740
Tiefbohren	742
Wendeschneidplattenbohrer	744
Handhabungshinweise	
Schneidplattenbohrer QTD	746
Wechselkopfbohrer TTD	748
Wechselkopfbohrer TTD-Tritan	750

Reiben und Feinbohren

Anschnittgeometrien und Spanwinkel	752
Handhabungshinweise	
HFS-System	754
HPR400 und HPR400 plus	756
Einschneidenreibahlen	758
EasyAdjust-System	760
Troubleshooting	764

Aufbohren und Drehen

Begriffserklärung und Formeln	766
Richtwerte der Mindestaufbohrdurchmesser	770
Troubleshooting	
Verschleißformen an Wendeschneidplatten	772
Aus der Praxis – für die Praxis	773

Anwendungshinweise Wechselkopfbohrer TTD-Tritan

Der dreischneidige Wechselkopfbohrer TTD-Tritan garantiert an der Schnittstelle eine optimale Drehmomentübertragung bei gleichzeitig hoher Wechsel- und Rundlaufgenauigkeit. Der Wechselkopf lässt sich schnell und prozesssicher wechseln, dabei ist eine falsche Positionierung unmöglich. Ein passender TORX®-Schlüssel mit Griff liegen dem Werkzeug bei, um den Wechselkopf über die Spezialspannschraube am Wechselkopfhalter exakt zu spannen.

Kühlmittelsituation:

Kühlmitteldruck abhängig von der Bohrtiefe: 3xD: 8 bar | 5xD: 12 bar



Maximaler Ein- und Austrittswinkel:

Beim Anbohren und beim Austritt an schrägen Flächen v_f um 50 % reduzieren.

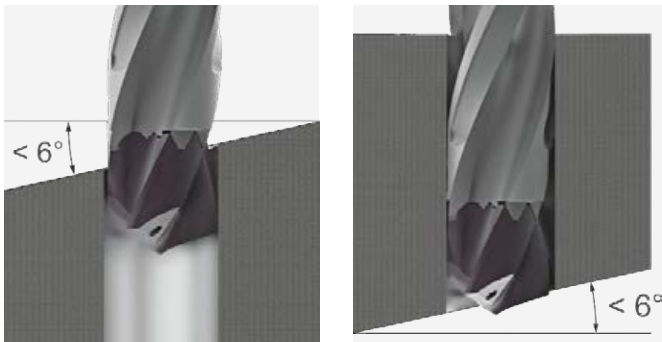

Durchgangsbohrung:

Beim Bohrungsaustritt wird empfohlen, keine Schnittwertreduzierungen vorzunehmen.

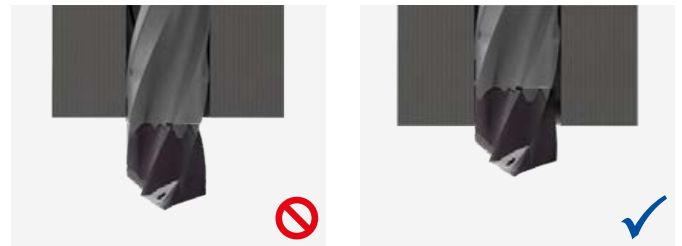

Rundlaufgenauigkeit:

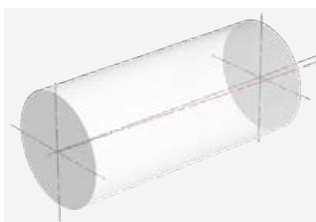

Max. 0,02 mm

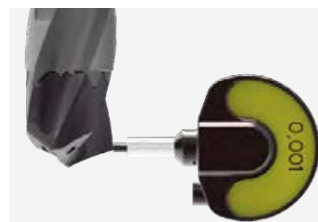

Max. 0,04 mm

Kein Eilgang beim Rückzug:

Für die Rückzugsgeschwindigkeit wird der fünffache Wert der Vorschubgeschwindigkeit empfohlen.

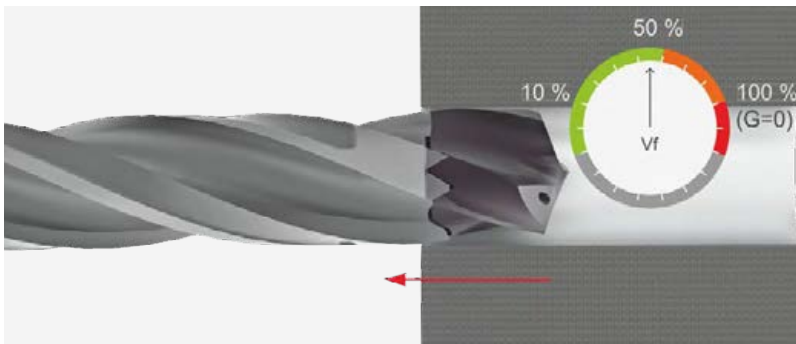
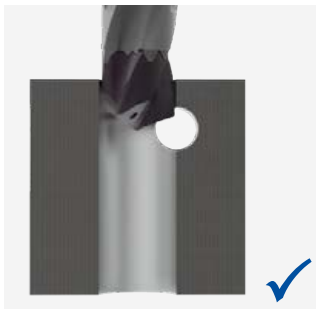
**Bearbeitungssituationen:**

Bohrung außermittig;
Querschnitte im Eingriff



Bohrung außermittig;
Querschnitte nicht im Eingriff

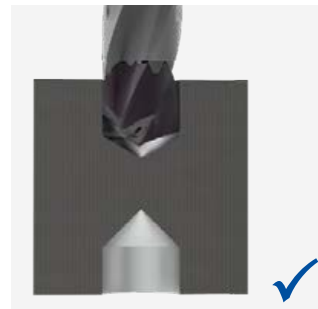

Durchbruch bei Gegenbohrung;
 $v_f = -50\%$

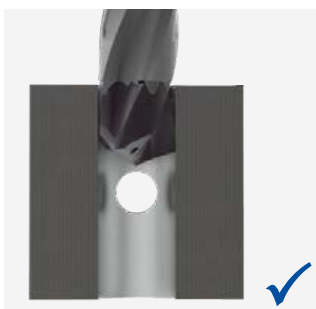

Bohrung mittig und $\ll D$



Bohrung mittig und $\approx D$



Bohrung mittig und $\gg D$

Tiefbohren

Für MEGA-Deep-Drill | MEGA-Deep-Drill-Alu

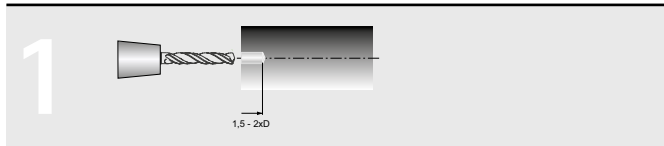

Pilotbohrung setzen

- Empfehlung für Pilotbohrer siehe folgende Seite (oder 0,01-0,02 mm größer als der Tiefbohrerdurchmesser)
- Tiefe der Pilotbohrung zwischen 1,5 und 2xD

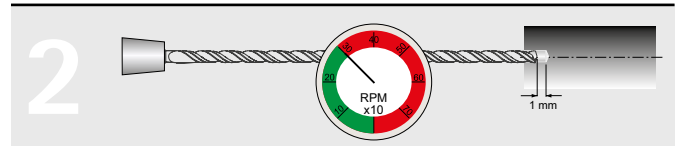

MEGA-Deep-Drill - Einfahren in die Pilotbohrung

- Einfahren mit max. 300 min⁻¹ und v_f = 1000 mm/min
- Ohne Kühlmittel - bis 1 mm vor dem Bohrungsgrund der Pilotbohrung
- Kühlmittel einschalten

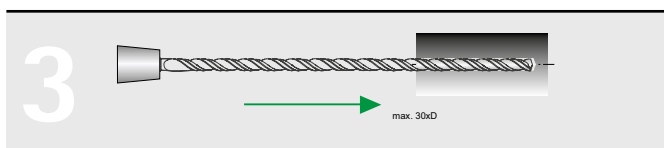

Bohren mit MEGA-Deep-Drill

- Schnittgeschwindigkeit (v_c) und Vorschübe (f) gemäß Tabelle (siehe Seite 286). Bohren ohne Entspanzyklen

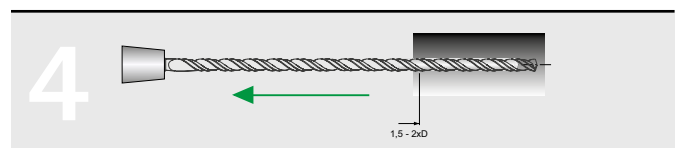

MEGA-Deep-Drill - Zurückfahren

- Zurückfahren mit aktueller Drehzahl und doppeltem Vorschub (= 2 x v_f) bis 1,5 - 2xD zum Ende der Bohrung

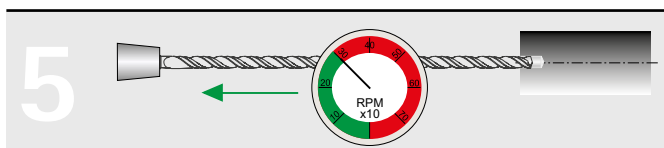

MEGA-Deep-Drill - Ausfahren aus der Bohrung

- Kühlmittel ausschalten
- Ausfahren mit max. 300 min⁻¹ und v_f = 1000 mm/min

Anwendungshinweise für Durchmesser ≤ 3 mm:

- Wahl eines für Kleinstwerkzeuge geeigneten Kühlmitteltyps für optimale Kühlschmierung
- Effektive Filtration des Kühlmediums, um ein Verstopfen der Kühlkanäle zu vermeiden
- Wahl eines geeigneten Bohrzyklus (ggf. Bohren mit Entspanzyklen)

Erforderlicher Kühlmitteldruck

Für MEGA-Deep-Drill | MEGA-Deep-Drill-Alu

	ø 3 - 5 mm	ø 5 - 8 mm	ø 8 - 12 mm	ø 12 - 16 mm
IK	60 bar	40 bar	30 bar	25 bar
MMS	12 bar	10 bar	9 bar	8 bar

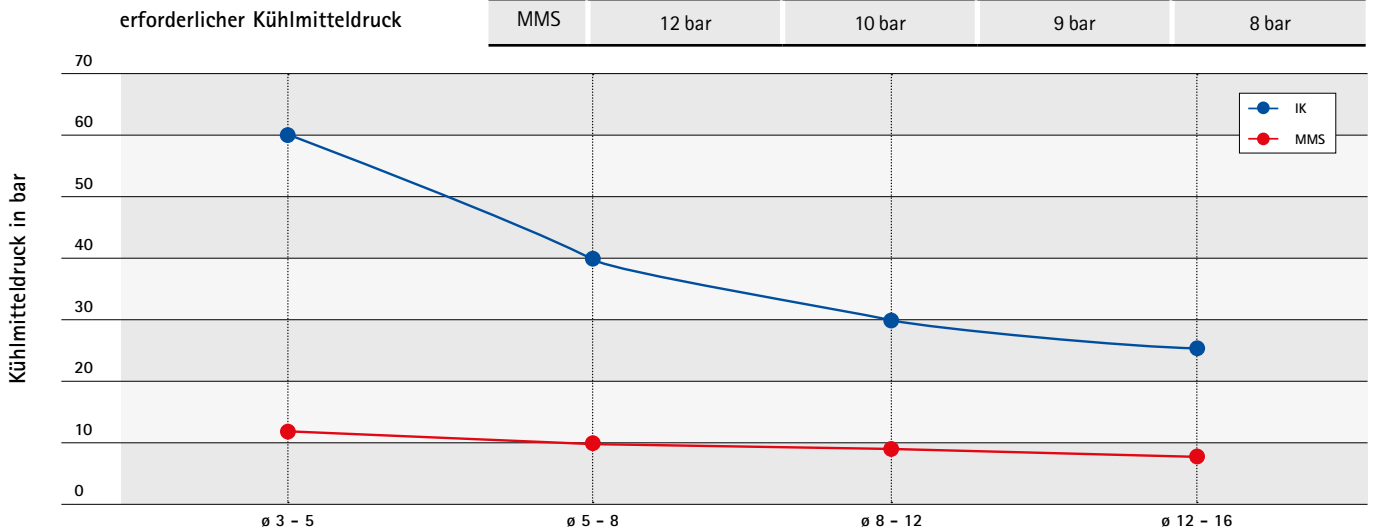

Tiefbohren 15xD - 30xD in zwei Schritten:

Tiefbohren 15xD - 30xD mit MEGA-Deep-Drill (SCD171) bzw. MEGA-Deep-Drill-Alu (SCD181)

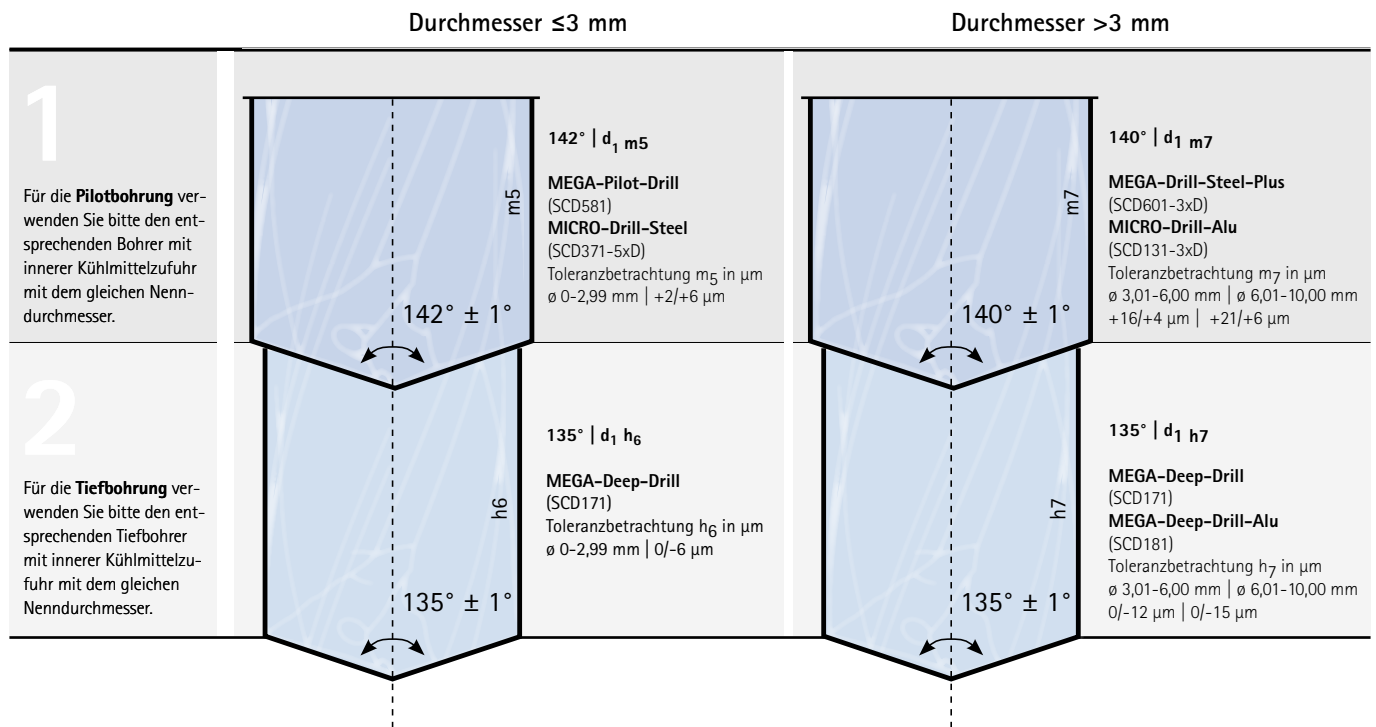

Tiefbohren 40xD in drei Schritten:

Tiefbohren 40xD mit MEGA-Deep-Drill (SCD171) bzw. MEGA-Deep-Drill-Alu (SCD181)

Optimal ausgelegt für eine prozesssichere Bearbeitung.

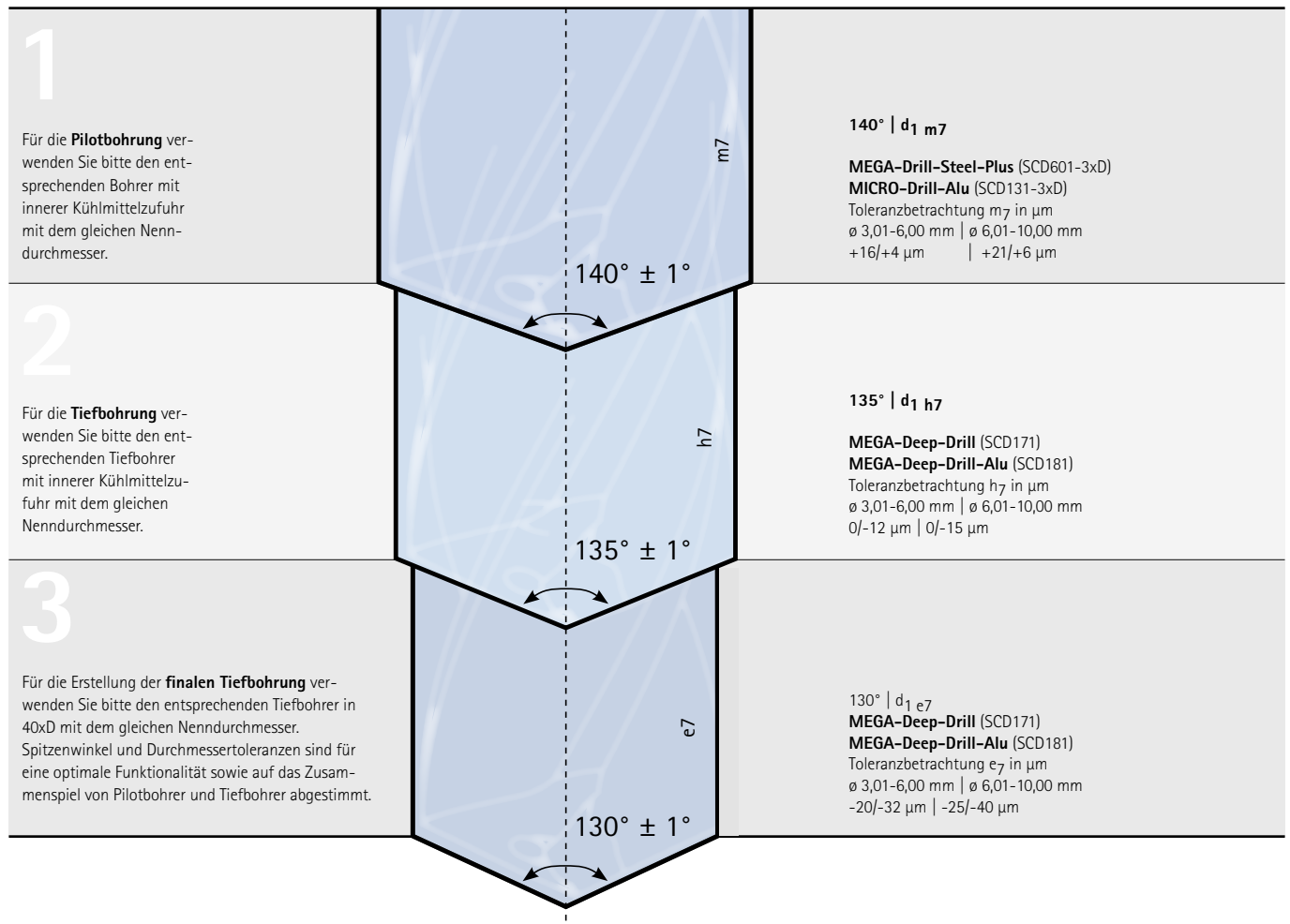

Anwendungshinweise für Wendeschneidplattenbohrer

HINWEISE

- Maximale Werkzeuglänge 5xD
- Beim Einsatz von Bohrern mit einem Längen-/Durchmesser Verhältnis größer drei, werden folgende Reduktionen beim Anbohren sowie beim Austritt des Bohrers bezüglich Schnittgeschwindigkeit v_c und Vorschub f empfohlen:
 - 3xD: v_c -20 % | f -30 %
 - 4xD: v_c -30 % | f -40 %
 - 5xD: v_c -40 % | f -50 %



**Idealerweise ist die Anbohrsituation plan, gesenkt oder vorgefräst.
Ist dies nicht der Fall, ist eine Reduktion des Vorschubes um 30 bis 60 Prozent erforderlich:**

- Anbohren und Austritt des Bohrers an schrägen und konkaven Flächen
- Bohreintritt in Querbohrungen
- Paketbohrungen
- Anbohren auf unebenen Oberflächen
- Anbohren auf einer Kante
- Anbohren auf einer balligen Oberfläche
- Anbohren auf einer spitzen Kontur
- Reihenbohrungen mit Überschneidungen
- Anbohren einer Zentrierung
- Kein Aufbohren möglich



Paketbohren



Anbohren einer balligen Fläche



Durchbohren mit Querbohrung



Anbohren einer spitzen Kontur



Anbohren auf unebener Fläche

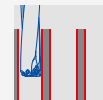

Reihenbohrungen sind materialabhängig bedingt möglich

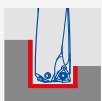

Anbohren auf einer Kante



Anbohren einer Zentrierung oder Sicke



Anbohren schräger Flächen / schräger Bohrungsaustritt



Aufbohren nicht möglich

Topographie am Bohrungsgrund bei Grundbohrungen

	Durchmesser D [mm]	A* [mm]	B* [mm]	C* [mm]
WOGT030206N-X40-HC698	16,00 - 20,90	3,61 (bei \varnothing 16) - 3,52 (bei \varnothing 20,9)	3,89 (bei \varnothing 16) - 6,93 (bei \varnothing 20,9)	0,40 (bei \varnothing 16) - 0,71 (bei \varnothing 20,9)
WOGT040206N-X40-HC698	21,00 - 25,90	4,06 (bei \varnothing 21) - 4,00 (bei \varnothing 25,9)	6,44 (bei \varnothing 21) - 8,95 (bei \varnothing 25,9)	0,76 (bei \varnothing 21) - 0,98 (bei \varnothing 25,9)
WOGT053006N-X40-HC698	26,00 - 30,90	5,18 (bei \varnothing 26) - 5,11 (bei \varnothing 30,9)	7,82 (bei \varnothing 26) - 10,34 (bei \varnothing 30,9)	0,81 (bei \varnothing 26) - 1,04 (bei \varnothing 30,9)
WOGT063008N-X40-HC698	31,00 - 44,90	6,41 (bei \varnothing 31) - 6,28 (bei \varnothing 44,9)	9,09 (bei \varnothing 31) - 16,18 (bei \varnothing 44,9)	1,06 (bei \varnothing 31) - 1,62 (bei \varnothing 44,9)
WOGT073808N-X40-HC698	45,00 - 54,90	7,70 (bei \varnothing 45) - 7,63 (bei \varnothing 54,9)	14,80 (bei \varnothing 45) - 19,82 (bei \varnothing 54,9)	1,57 (bei \varnothing 45) - 7,63 (bei \varnothing 54,9)

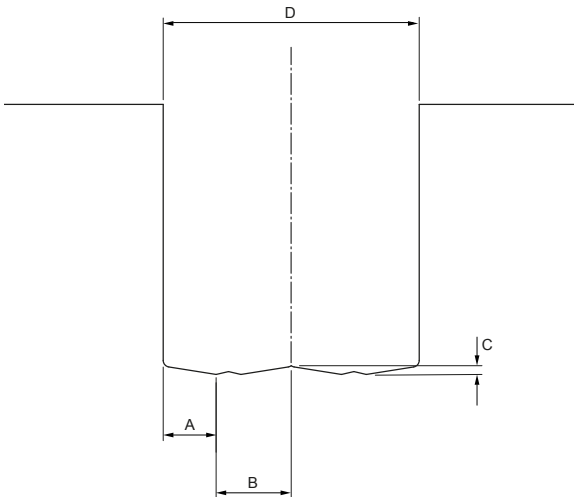
**Sicherheitshinweis:**

Bei Durchgangsbohrungen fällt beim Austritt des Bohrers ein scharfkantiger Bohrungsdeckel bzw. eine Scheibe ab. Es besteht die Gefahr, dass diese weggeschleudert wird und es dadurch zu Schäden oder Verletzungen kommt. Um dies zu vermeiden, sind entsprechende Schutzvorkehrungen zu treffen.

* Bedingt durch die Einbaulage und den Anstellwinkel der Schneidplatten variieren A, B und C.

Handhabungshinweise für Schneidplattenbohrer QTD

Einfaches Wechseln und Einstellen der QTD-Schneiden

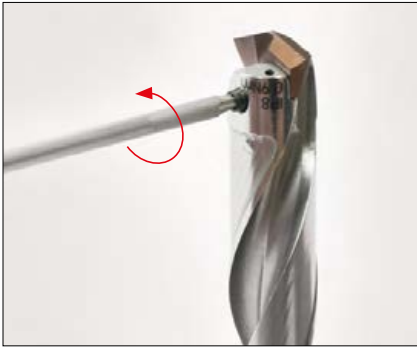

1. Lösen Sie die Spezialschraube mit Hilfe des mitgelieferten TORX® PLUS-Schlüssels, indem Sie gegen den Uhrzeigersinn drehen.



2. Entnehmen Sie die Schneidplatte aus dem Plattensitz.



3. Reinigen Sie den Plattensitz mit Druckluft.

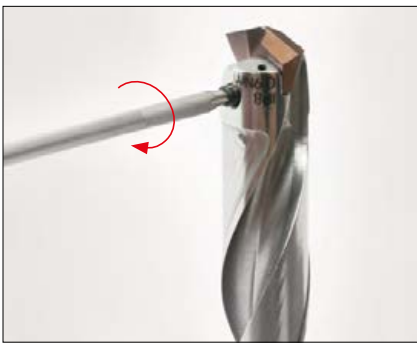

4. Setzen Sie die neue Schneidplatte in den Plattensitz. Ziehen Sie die Spezialschraube mit Hilfe des mitgelieferten TORX® PLUS-Schlüssels im Uhrzeigersinn handfest an.



5. Ziehen Sie die Spezialschraube mit dem vorgegebenen Anzugsdrehmoment an.

HINWEISE

- Verwenden Sie ausschließlich die Originalschrauben!
- Spätestens beim 5. Bohrkopfwechsel muss die Spezialschraube ausgetauscht werden
- Auf dem Werkzeug ist das gültige Anzugsdrehmoment eingraviert

Ergebnis:

Die Schneidplatte ist nun vollständig gewechselt und das Werkzeug kann eingesetzt werden.



Notizen

Handhabungshinweise Wechselkopfbohrer TTD

Hinweise für die Praxis

PILOTIEREN

- Ab Bohrtiefen von 8xD ist eine Pilotbohrung zu empfehlen
- Beim Wechselbohrkopf Typ 02 ist eine Pilotbohrung ab einer Bohrtiefe von 5xD zu empfehlen
- Bei einer Pilotbohrung mit dem Wechselbohrkopf Typ 02 ist eine Reduzierung des angegebenen Vorschubs um 50 % zu empfehlen
- Bei einer Pilotbohrung mit den Wechselbohrköpfen Typ 01 und Typ 03 können die empfohlenen Arbeitswerte verwendet werden
- Das Einfahren in die Pilotbohrung erfolgt mit gleicher Bohrkopf-geometrie und reduzierten Arbeitswerten (Empfehlung: $v_c = 50\%$ und $f = 50\%$) bis 1 mm vor dem Bohrungsgrund
- Das Bohren nach dem Pilotieren erfolgt dann mit den empfohlenen Arbeitswerten (siehe Seiten 224–227)

HINWEISE ZUM BOHREN MIT 12xD-HALTER

- Bei einer Bohrtiefe von 12xD ist eine Pilotbohrung notwendig
- Kühlmitteldruck muss mindestens 40 bar entsprechen
- Bei der Bearbeitung von Stahlwerkstoffen kann Entspannen notwendig sein
- Bei angetriebenem Werkzeug ist ein Einsatz auf der Drehmaschine möglich
- Eine Erhöhung der Schnittgeschwindigkeit um 30 % gegenüber dem Standardwert ist zu empfehlen

Stehendes Werkzeug

Bei stehendem Werkzeug Spanraumauslauf waagrecht positionieren, damit kein Spänestau entsteht.

Durchgangsbohrung

Beim Bohrungsaustritt wird empfohlen, keine Schnittwert-reduzierung vorzunehmen.

Kühlmittelsituation

Kühlmitteldruck abhängig von der Bohrtiefe:

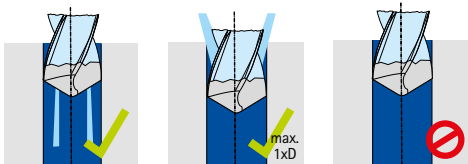

1xD: 8 bar | 3xD: 8 bar | 5xD: 12 bar | 8xD: 25 bar | 12xD: 40 bar

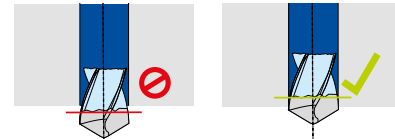

Rundlaufgenauigkeit

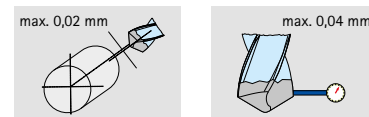

Max. Ein- und Austrittswinkel

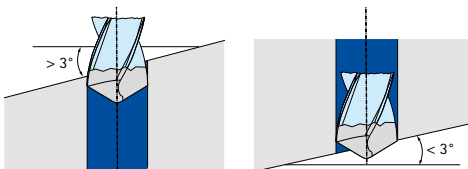

Kein Eilgang beim Rückzug

Für die Rückzugsgeschwindigkeit wird der 5-fache Wert der Vorschubgeschwindigkeit empfohlen.

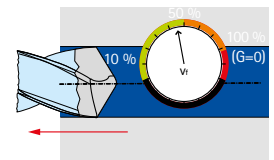

Bearbeitungssituationen



Bohrung außermittig
Querschnitte im Eingriff

Bohrung außermittig
Querschnitte nicht im Eingriff

Durchbruch bei
Gegenbohrung

Bohrung mittig
und $\ll D$

Bohrung mittig
und $= D$

Bohrung mittig
und $\gg D$

Montage

Bohrkopf lösen

1. Prüfen Sie bei jedem Bohrkopfwechsel die Spannschraube auf Schwergängigkeit. Lässt sich die Spannschraube leicht lösen, muss die Spannschraube ausgetauscht werden. Verwenden Sie ausschließlich die Originalspannschrauben!

Hinweis:

Spätestens beim 8. Bohrkopfwechsel muss die Spannschraube ausgetauscht werden.



2. Öffnen Sie die Spannschraube mit Hilfe des mitgelieferten Sechskant-Schraubenschlüssels.

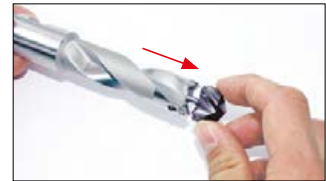

3. Ziehen Sie den Bohrkopf aus der Verzahnung.

Bohrkopf spannen



1. Säubern Sie die TTS-Schnittstelle des Halters mit einer Bürste.

2. Stecken Sie den neuen Bohrkopf auf den Halter.

3. Ziehen Sie die Spannschraube im Uhrzeigersinn handfest an.

Hinweis:

Achten Sie darauf, dass die Positionierhilfe des Bohrkopfes mit der Positionierhilfe des Halters in Eingriff ist und dass Spannnut und Verzahnung von Bohrkopf und Halter übereinstimmen.

Anzugsdrehmomente der Spannschraube

Durchmesserbereich [mm]	Gewinde Wechselkopfhalter	Schlüsselweite sw	Zulässiges übertragbares Anzugsdrehmoment [Nm]
12,00 - 13,49	M2,5	1,3	1,0
13,50 - 16,49	M3	1,5	1,3
16,50 - 24,49	M4x0,5	2	3,5
24,50 - 32,49	M5x0,5	2,5	4,0
32,50 - 41,49	M6x0,5	3	6,0
41,50 - 45,49	M8x1	4	10,0

Handhabungshinweise Wechselkopfbohrer TTD-Tritan

Werkzeugmontage

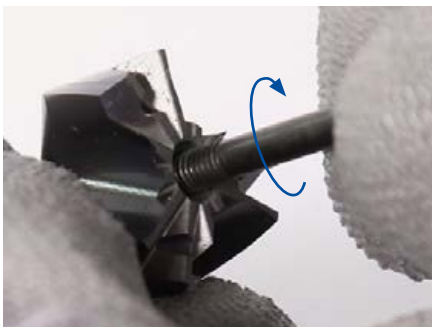

- 1. Spezialspannschraube einsetzen und eindrehen**
Die Spezialspannschraube mit der kleinen Gewindegewinde-Seite voraus in die Bohrung des Wechselbohrkopfs einsetzen. Anschließend die Spezialspannschraube im Uhrzeigersinn bis zum Anschlag eindrehen.



- 2. Reinigen mit Druckluft**
Den Wechselkopfhalter und Wechselbohrkopf mit Druckluft reinigen.



- 3. Wechselbohrkopf aufstecken**
Wechselbohrkopf auf Wechselkopfhalter stecken.

Hinweis:

Die Spezialspannschraube ist bei Lieferzustand bereits am Wechselbohrkopf montiert. Im gelösten Zustand lässt sich die Spezialspannschraube durch Eindrehen wieder am Wechselbohrkopf montieren.

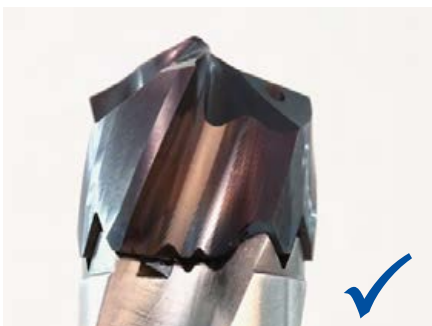

- 4. Positionierung des Bohrkopfs überprüfen**
Überprüfen, ob Spannut und Verzahnung von Wechselbohrkopf und Wechselkopfhalter übereinstimmen.
Bei Nichtübereinstimmung, den Wechselbohrkopf so lange drehen, bis Spannut und Verzahnung übereinstimmen.

Ergebnis:

Spannut und Verzahnung stimmen überein (links) | stimmen nicht überein (rechts)

- 1 Griff für TORX®-Schlüssel
- 2 Wechselkopfhalter TTS
- 3 TORX®-Schlüssel
- 4 Wechselbohrkopf mit Spezialspannschraube



5. **Spezialspannschraube bis zum Anschlag anziehen**
Den Wechselbohrkopf leicht an den Wechselkopfhalter gedrückt halten, damit er seine aufgesteckte Position beibehält. Anschließend den TORX®-Schlüssel in die zentrale Bohrung des Wechselkopfhalters schieben, bis hin zur Gewindebohrung der Spezialspannschraube. Dann die Spezialspannschraube mit dem TORX®-Schlüssel gegen den Uhrzeigersinn bis zum Anschlag handfest anziehen.



6. Spezialspannschraube mit Anzugsdrehmoment anziehen

Mit einem passenden Drehmomentschlüssel mit Innensechskant-Bit in Kombination mit dem TORX®-Schlüssel und dem vorgegebenen Anzugsdrehmoment die Spezialspannschraube anziehen.

Hinweis:

Das vorgegebene Anzugsdrehmoment der Spezialspannschraube steht an der Unterseite des Wechselkopfhalters.

Ergebnis:

Die Spezialspannschraube ist mit dem vorgegebenen Anzugsdrehmoment angezogen und der Wechselbohrkopf ist mit dem Wechselkopfhalter fest verbunden. Der Montagevorgang ist abgeschlossen.

Lieferumfang:

- 1 Griff für TORX®-Schlüssel
- 2 Wechselkopfhalter TTS
- 3 TORX®-Schlüssel

Anzugsdrehmomente der Spezialspannschraube

Durchmesserbereich [mm]	Gewinde Wechselkopfhalter	TORX®-Größe	Zulässiges übertragbares Anzugsdrehmoment [Nm]
12,00 - 13,99	M3 x 0,5	T6	0,40
14,00 - 17,49	M3,5 x 0,6	T7	0,70
17,50 - 19,49	M4 x 0,7	T8	1,30
19,50 - 24,49	M5 x 0,8	T10	2,00
24,50 - 28,49	M6 x 1,0	T15	3,10
28,50 - 32,49	M6 x 1,0	T15	5,60

Anschnittgeometrien und Spanwinkel Mehrschneidenreibahle

Baureihe FXR, MOR, MPR, HPR

Anschnitt

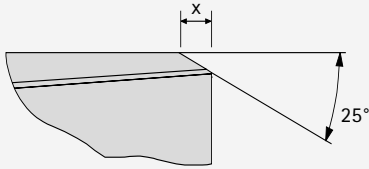
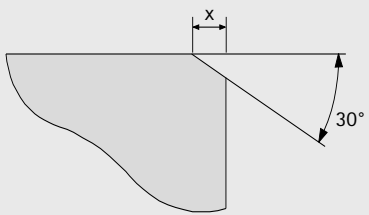
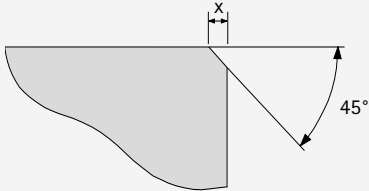
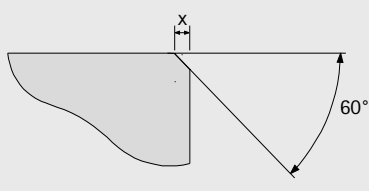
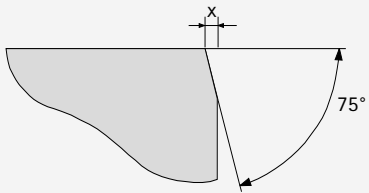
Geometrie	Anschnittgeometrie	
	Bezeichnung	Geometrie
	ML	25°
	ME	30°
	MF	
	MG	
	MY	
	MC	45°
	MO	
	MU	
	MV	60°
	MT	
	MA	75°

Spanform/Spanwinkel

Spanwinkel	
Bezeichnung	Winkel
0A	0°
1F	5°
1G	6°
1M	13°
2A	0° (für Grundbohrung)
2G	6° (für Grundbohrung)
3C	-2°

Erklärung Schneidstoffe	
Bezeichnung	Erklärung
HU	Hartmetall unbeschichtet
HP	Hartmetall PVD-beschichtet
HC	Hartmetall CVD-beschichtet
CU	Cermet unbeschichtet
CP	Cermet PVD-beschichtet
PU	PKD

x = Anschnittlänge

Übersicht Baureihe | Durchmesserbereich | Anschnittbezeichnung | Anschnittlänge

Baureihe	Anschnittbezeichnung	Durchmesserbereich	Anschnittlänge x	Baureihe	Anschnittbezeichnung	Durchmesserbereich	Anschnittlänge x
FXR	MC	2,81 - 3,35	0,30	MOR	MY	7,70 - 40,20	1,00
		3,36 - 4,05	0,40		MU	7,70 - 40,20	0,60
		4,06 - 5,60	0,50	MRP	MG	3,85 - 6,20	0,90
		5,61 - 6,60	0,60			6,21 - 10,70	1,20
		6,61 - 7,60	0,70			10,71 - 20,20	1,50
		7,61 - 11,60	0,80			20,21 - 40,20	1,50
		11,61 - 20,10	1,00		MV	3,85 - 6,20	0,30
	MF	2,81 - 3,70	0,70	6,21 - 10,70		0,40	
		3,71 - 6,20	0,90	10,71 - 20,20		0,50	
		6,21 - 12,20	1,20	20,21 - 26,20		0,60	
		12,21 - 20,20	1,50	26,21 - 40,20		0,80	
	MG	2,81 - 3,70	0,70	HPR	MA	7,00 - 65,00	0,40
		3,71 - 6,20	0,90		MC	7,00 - 65,00	0,55
		6,21 - 12,20	1,20		ME	7,00 - 65,00	1,40
		12,21 - 20,20	1,50		MF	7,00 - 65,00	1,40
	MT	2,81 - 6,20	0,30		ML	7,00 - 65,00	1,00
		6,21 - 10,70	0,40		MO	7,00 - 65,00	0,60
		10,71 - 16,20	0,50				
		16,21 - 20,20	0,60				
	MV	2,81 - 6,20	0,30				
		6,21 - 10,70	0,40				
		10,71 - 16,20	0,50				
		16,21 - 20,20	0,60				

Handhabungshinweise für HFS®-System

MAPAL HFS®-System mit Axialspannung

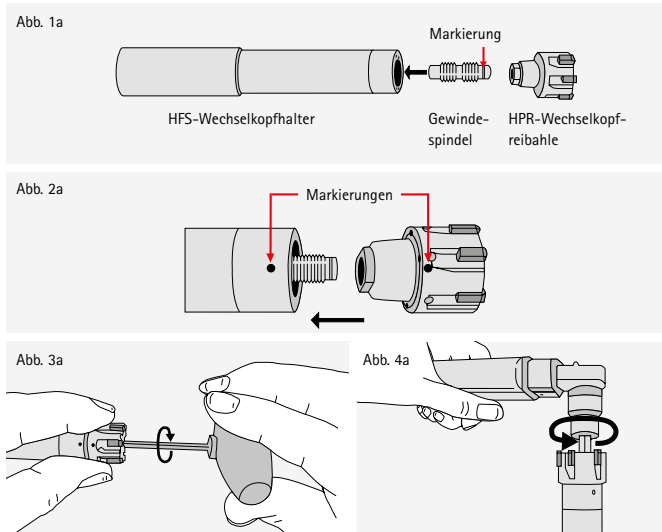

MAPAL HFS®-System mit Radialspannung

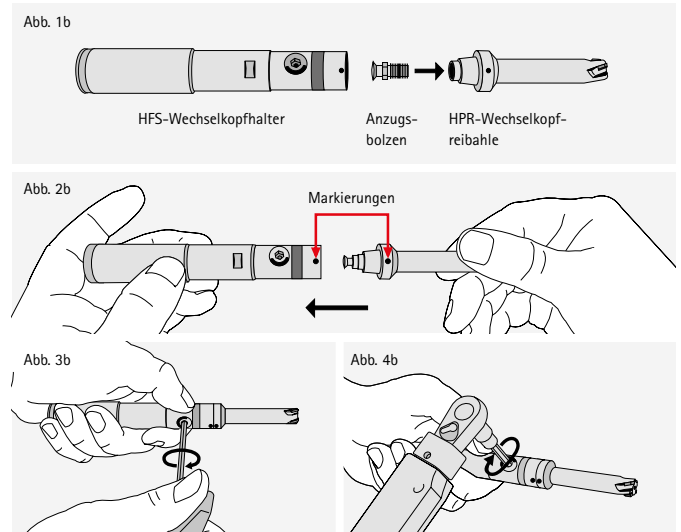

Reinigung

Alle Einzelteile reinigen und darauf achten, dass der Innen- und Außenkegel sowie die Planfläche des HFS-Kegels frei von Fremdkörpern (z. B. Späne) sind. Zur Reinigung des Innenkegels wird ein spezieller Kegelwischer (siehe Seite 474) empfohlen.

Spannen

- Das Ende der Gewindespindel ohne Markierung in den HFS-Wechselkopfhalter einsetzen, ohne dabei die Gewindespindel einzuschrauben (siehe Abb. 1a).
- Die HPR-Wechselkopfreibahle auf die Gewindespindel aufsetzen. Dabei die Markierungen der HPR-Wechselkopfreibahle und des HFS-Wechselkopfhalters in eine Flucht bringen: "Punkt auf Punkt" (siehe Abb. 2a). Anschließend die HPR-Wechselkopfreibahle in den HFS-Wechselkopfhalter ganz einsetzen und beide Teile festhalten.
- Die HPR-Wechselkopfreibahle und den HFS-Wechselkopfhalter mit einem Innensechskantschlüssel zusammenschrauben und fest anziehen. Darauf achten, dass die Markierungen fluchten und die Planfläche anliegt (siehe Abb. 3a). **Hinweis:** HPR 100, 110, 150 werden durch die Reibahle angezogen (Drehrichtung im Uhrzeigersinn). HPR 130, 131, 180 werden durch den Halter angezogen (Drehrichtung gegen den Uhrzeigersinn). Die Drehrichtungen sind auf dem Halter angegeben.
- Hinweis:** Die HFS-Wechselkopfhalter sind mit dem benötigten Anzugsdrehmoment beschriftet. Die HPR-Wechselkopfreibahle mit dem Drehmomentschlüssel im Uhrzeigersinn anziehen (siehe Abb. 4a).

Spannen

- Den Anzugsbolzen mit der Gewindeseite in die HPR-Wechselkopfreibahle mit Linksgewinde einschrauben (siehe Abb. 1b).
- Die HPR-Wechselkopfreibahle komplett in den HFS-Wechselkopfhalter einsetzen. Dabei die Markierungen der HPR-Wechselkopfreibahle und des HFS-Wechselkopfhalters in eine Flucht bringen: „Punkt auf Punkt“ (siehe Abb. 2b). Anschließend beide Teile festhalten.
- Den Spannbolzen mit dem Innensechskantschlüssel im Uhrzeigersinn drehen (siehe Abb. 3b). Die Drehrichtung ist auf dem HFS-Wechselkopfhalter angegeben.
- Hinweis:** Die HFS-Wechselkopfhalter sind mit dem benötigten Anzugsdrehmoment beschriftet. Die HPR-Wechselkopfreibahle mit dem Drehmomentschlüssel im Uhrzeigersinn anziehen (siehe Abb. 4b).

Trennstellengröße HFS	Anzugsdrehmoment [Nm]	
	axial	radial
10	4	-
12	6	7
14	6	7
16	15	12
20	15	12
24	20	-

Lösen

- Hinweis:** Die Drehrichtung beim Lösen der HPR-Wechselkopfreibahle ist entgegen der Drehrichtung des Spannvorgangs. Zum Lösen der HPR-Wechselkopfreibahle die Gewindespindel mit einem Innensechskantschlüssel drehen.
- Die HPR-Wechselkopfreibahle entnehmen.

Lösen

- Zum Lösen der Reibahle den Spannbolzen mit einem Innensechskantschlüssel gegen den Uhrzeigersinn bis zum Anschlag drehen.
→ Die HPR-Wechselkopfreibahle wird ausgeworfen und kann entnommen werden.

Justierung der HPR-Wechselkopfreibahle mit Feinjustierung

- Hinweis:** Das gegenüberliegende Schneidenpaar in Verlängerung zu den runden Markierungspunkten an HFS-Wechselkopfhalter und HPR-Wechselkopfreibahle dient als Referenz für die Messung und Justierung des Werkzeugdurchmessers. Die HPR-Wechselkopfreibahle im HFS-Wechselkopfhalter befestigen.
- Den gewünschten Werkzeugdurchmesser per Feinzeigermessschraube einstellen. Anschließend die Feinzeigermessschraube an die Referenzschneiden anlegen.
- Den TORX®-Schlüssel an der Stellschraube anlegen und langsam im Uhrzeigersinn drehen. Die HPR-Wechselkopfreibahle auf das gewünschte Maß einstellen.



Bitte beachten bei HPR-Varianten mit Justiersystem:

Bei feinjustierbaren HPR-Wechselkopfreibahnen bis \varnothing 30 mm und HFS-Größe 12 bis 20 ist ein Spannen der HPR-Wechselkopfreibahle nur radial möglich. Ab \varnothing 30 mm und HFS-Größe 24 kann die HPR-Wechselkopfreibahle auch über die Gewindespindel gespannt werden.

Kühlmittelführung für HFS®-System

Um die hohe Leistungsfähigkeit der HPR-Reibahlen voll auszuschöpfen, benötigen die verschiedenen Baureihen der Wechselköpfe jeweils die passende Kühlmittelführung. Der Unterschied in den Bauteilen liegt dabei in der Gewindespindel bzw. den Anzugsbolzen. Diese werden je nach Kopfvariante mit Kühlmitteldurchgang bzw. ohne Kühlmitteldurchgang verwendet, damit eine direkte Kühlmittelführung über die Trennstelle bis direkt auf die Schneiden gewährleistet ist.

Hinweis:

Bei allen Haltern mit HFS Größe 12 befinden sich immer beide Ausführungen im Lieferumfang. Bei der Montage muss daher darauf geachtet werden, dass das zum Wechselkopf passende System ausgewählt wird. (siehe Abb. unten)

Kühlmittelführung ohne zentralen Durchgang

Die Reibahlen müssen ohne zentralen Kühlmitteldurchgang montiert werden. Der Kühlmittelübergang erfolgt vom Halter in den Wechselkopf über die Planfläche.

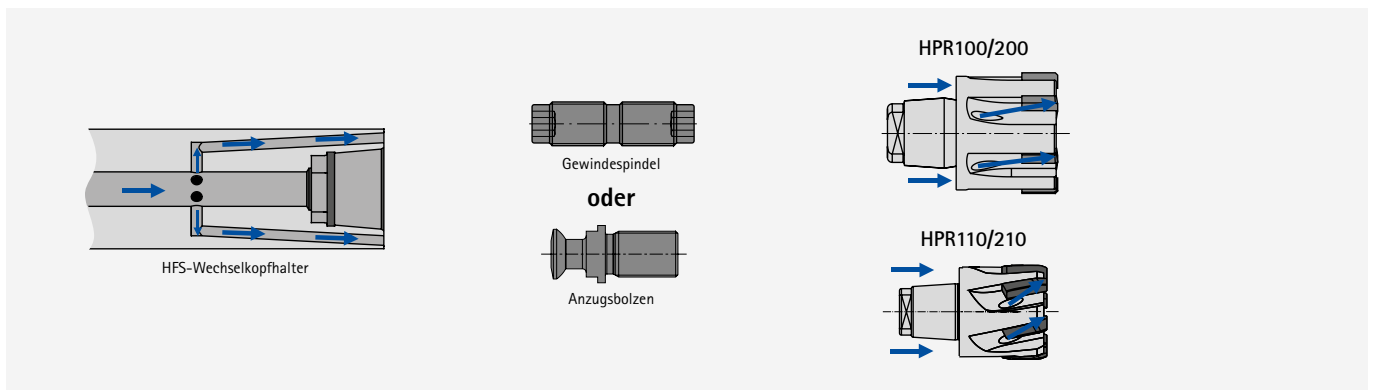

Kühlmittelführung mit zentralem Durchgang

Alle aufgeführten Reibahlen müssen mit zentralem Kühlmitteldurchgang montiert werden. Der Kühlmittelübergang erfolgt zentral und beim HPR150 sowie beim HPR250 zusätzlich über die Planfläche.

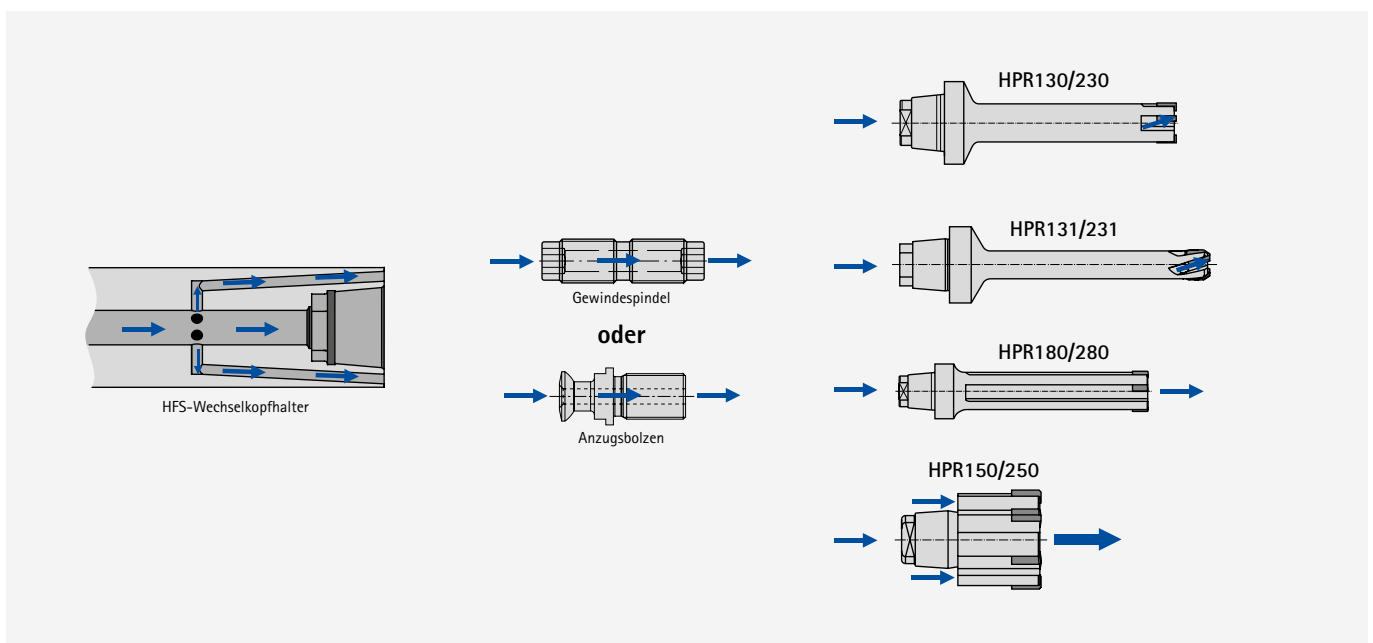

Handhabungshinweise für HPR400

Der HPR400 bietet ein System, bei dem das Werkzeug schnell und wirtschaftlich direkt beim Kunden neu bestückt werden kann. Die austauschbaren Schneidplatten werden axial in den Schneidplattensitz geschoben und mit einer TORX®-Schraube stabil im Grundkörper fixiert. Die gewohnte µm-genaue Bearbeitungsqualität bleibt dabei stets gegeben.

Wechseln der Schneidplatten

Hinweis:

Beim Schneidplattenwechsel müssen alle Schneidplatten komplett ausgetauscht werden!



1. Den HPR400 mit Druckluft und Tuch reinigen.
Die TORX®-Schraube lösen, hierfür mit einem passenden TORX®-Schraubendreher die TORX®-Schraube gegen den Uhrzeigersinn drehen.
Nach dem Lösen die TORX®-Schraube entnehmen.



2. Die Schneidplatte vorsichtig in axialer Richtung aus dem Schneidplattensitz schieben und entnehmen. Die übrigen Schneidplatten entnehmen, hierfür die Handlungsschritte 1 und 2 wiederholen.



Anmerkung:

Nur für geschultes Personal.

3. **Hinweis:** Bei Verschmutzung die Anlageflächen der Schneidplatten reinigen.

Die Schneidplattensitze mit Druckluft reinigen.
Anschließend unter sachgemäßer Verwendung von Reinigungsalkohol die Plattensitze reinigen.



4. Die neue Schneidplatte bis zur Hälfte in den Schneidplattensitz legen. Anschließend die Schneidplatte mit dem Daumen leicht in den Schneidplattensitz drücken und gleichzeitig die Schneidplatte axial nach unten in die Endposition schieben.
Um das Herausfallen der Schneidplatte zu verhindern, die Schneidplatte mit der TORX®-Schraube fixieren.



5. **Hinweis:** Die TORX®-Schrauben nur mit einem passenden Drehmomentschlüssel anziehen.
Die TORX®-Schraube mit einem Anzugsdrehmoment von 3,1 Nm anziehen.

Ergebnis:

Die Schneidplatten sind vollständig gewechselt und der HPR400 ist einsatzbereit.

Handhabungshinweise HPR400 plus

Die vierschneidigen Schneidplatten des HPR400 plus werden so genau hergestellt, dass ein Wenden, beziehungsweise Wechseln der Schneidplatten weiterhin vor Ort durch Kundenmitarbeiter problemlos möglich ist.



Wechseln der Schneidplatten

Voraussetzung:

Das Werkzeug vor Beginn des Schneidplattenwechsels reinigen.

Anmerkung:

Nur für geschultes Personal.



1. Die TORX® PLUS-Schraube mit einem passenden Schraubendreher lösen, hierzu die TORX® PLUS-Schraube gegen den Uhrzeigersinn drehen. Anschließend die TORX® PLUS-Schraube entnehmen.



2. Die Schneidplatte in axialer Richtung vorsichtig nach oben aus dem Schneidplattensitz schieben und entnehmen. Die übrigen Schneidplatten entnehmen.



3. Die Plattensitze mit Druckluft reinigen und unter sachgemäßer Verwendung von Reinigungsalkohol die Plattensitze reinigen. Die Anlageflächen der Schneidplatten mit Reinigungsmasse säubern.

Hinweis:

Beim Schneidplattenwechsel müssen alle Schneidplatten gewendet oder ausgetauscht werden!

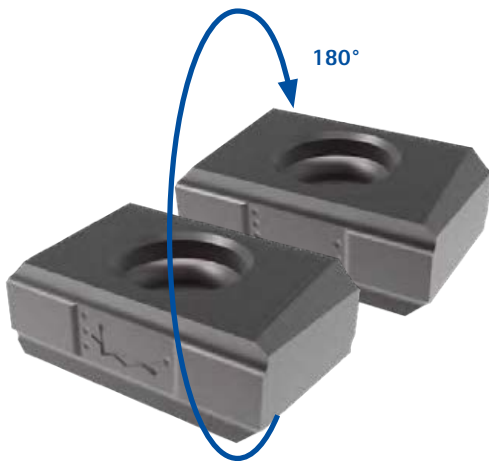

Hinweis:

Beim Wenden der Schneidplatte die Reihenfolge der Schneidkanten mit Hilfe der Markierungspunkte beachten (ein bis vier Punkte).



4. Die neue oder gewendete Schneidplatte bis zur Hälfte in den Plattensitz setzen. Anschließend die Schneidplatte mit dem Daumen leicht in den Plattensitz drücken und gleichzeitig die Schneidplatte axial nach unten in den Plattensitz schieben. Daraufhin die Schneidplatte mit der TORX® PLUS-Schraube fixieren.



5. Die TORX® PLUS-Schraube mit dem vorgegebenen Anzugsdrehmoment im Uhrzeigersinn anziehen.

Hinweis:

Die TORX® PLUS-Schrauben nur mit einem passenden Drehmomentschlüssel anziehen. Das Anzugsdrehmoment für die TORX® PLUS-Schrauben beträgt 3,5 Nm.

Ergebnis:

Die Schneidplatten sind vollständig gewechselt und das Werkzeug ist einsatzbereit.

Einstellhinweise für WP-Einschneidenreibahlen

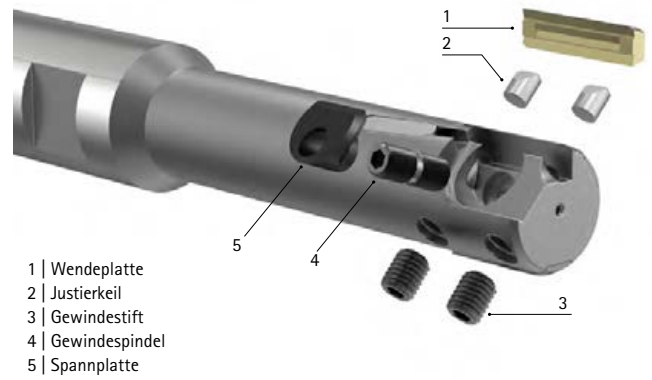

- 1 | Wendeplatte
- 2 | Justierkeil
- 3 | Gewindestift
- 4 | Gewindespindel
- 5 | Spannplatte



1. Beide Gewindestifte $\frac{1}{2}$ Umdrehung gegen den Uhrzeigersinn drehen.



2. Spannplatte lösen:
Gewindespindel von beiden Seiten 2-3 Umdrehungen gegen den Uhrzeigersinn drehen (Wendeplatte zeigt nach unten).

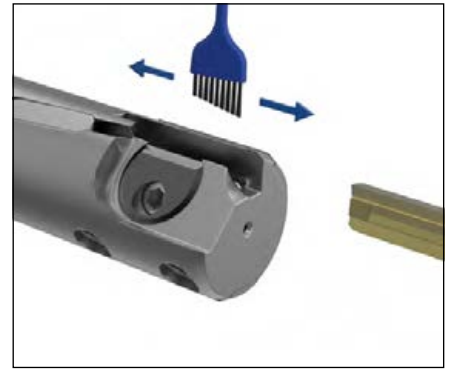

3. Wendeplatte entnehmen.
4. Wendeplatte und Wendeplattensitz reinigen.

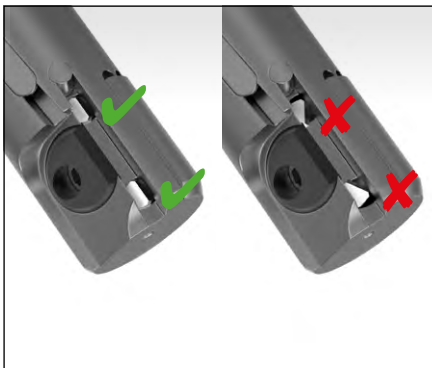

5. Auf eine gerade Positionierung der Justierkeile achten.
6. Neue oder gedrehte Wendeplatte in den Wendeplattensitz einsetzen.

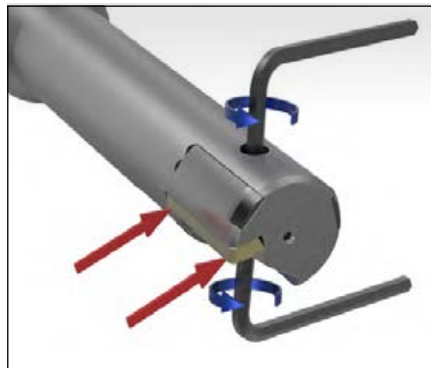

7. Wendeplatte gedrückt halten und Gewindespindel von beiden Seiten im Uhrzeigersinn mit dem benötigten Anzugsdrehmoment anziehen.
8. Beide Gewindestifte $\frac{1}{4}$ Umdrehung im Uhrzeigersinn drehen.

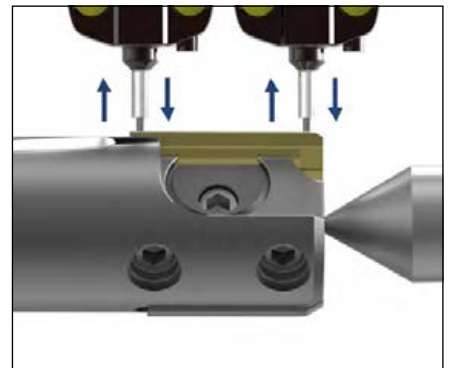

9. Vorderes und hinteres Einstellmaß in wechselnden Intervallen mit den Gewindestiften einstellen. Verjüngung nach hinten ca. $1 \mu\text{m}/\text{mm}$.

HINWEIS:

Eine Übersicht der Anzugsdrehmomente im PDF-Format, befindet sich auf der MAPAL Webseite:

www.mapal.com → Mediathek → Anleitungen und Handhabungshinweise → Allgemeine technische Informationen → Anziehdrehmomente für MAPAL Spannschrauben

Einstellhinweise für HX-Einschneidenreibahlen

Größe 2 und Größe 3

- | | |
|--------------------|------------------|
| 1 Spannplatte | 4 Kasette |
| 2 Gewindespindel | 5 Justierkeil |
| 3 HX-Wendeplatte | 6 Gewindestift |

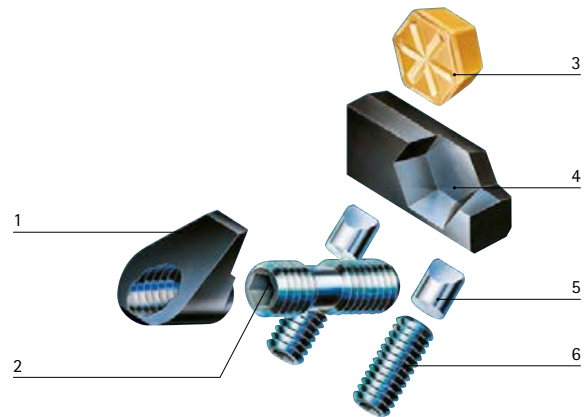

Wendeplattenwechsel und Einstellung

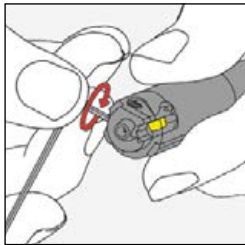

1. Den vorderen und hinteren Gewindestift eine halbe Umdrehung nach links drehen.

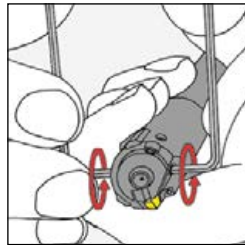

2. **Hinweis:** Zum Öffnen müssen zwei Schlüssel verwendet werden. Zum Lösen der Spannplatte und der Kasette die Gewindespindel im und gegen den Uhrzeigersinn drehen.

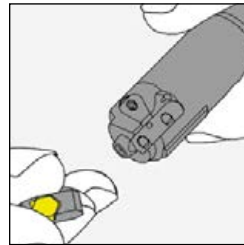

3. Die Wendeplatte und die Kasette herausnehmen. Die Wendeplatte, die Kasette und den Wendeplattensitz reinigen (keine Druckluft verwenden, Justierkeile beachten). Die Wendeplatte um 60° weiterdrehen bzw. eine neue Wendeplatte in die Kasette einsetzen. Die Kasette wieder einbauen.

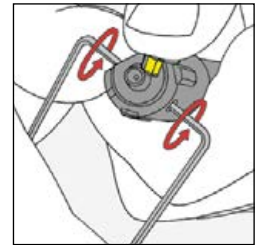

4. **Hinweis:** Zum Anziehen müssen zwei Schlüssel verwendet werden. Die Wendeplatte und die Kasette gegen den hinteren Anschlag und den Justierkeil drücken. Die Gewindespindel von oben nach rechts und von unten nach links drehen und anziehen.

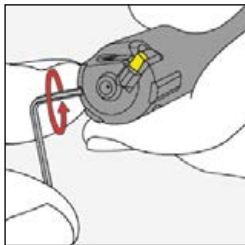

5. Zur Grobeinstellung den vorderen und hinteren Gewindestift eine viertel Umdrehung nach rechts drehen.

Für einfachste Handhabung und garantierte Einstellsicherheit empfehlen wir die Verwendung eines MAPAL Einstellgerätes.

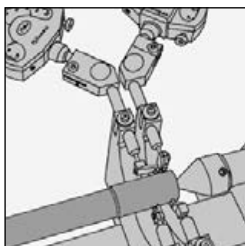

7. Das MAPAL MASTERSET mit Einstellhorn (muss separat bestellt werden) eichen. Der Einstellhorn hat das Kleinmaß der Bohrung.

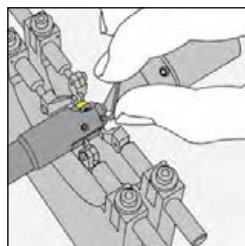

8. Das vordere und hintere Einstellmaß in wechselnden Intervallen mit den Gewindestiften einstellen. Die Verjüngung nach hinten beträgt ca. 0,005 bis 0,010 mm.

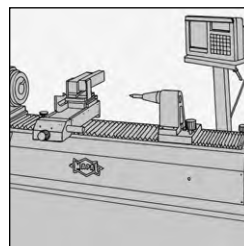

9. MAPAL UNISET: Zur komfortablen Einstellung der Reibahlen bietet MAPAL elektronische Einstellgeräte in vertikaler und horizontaler Ausführung an. Mehr Informationen finden Sie im Katalog "EINSTELLEN | MESSEN | AUSGEBEN".

Detaillierte Einstellhinweise siehe Bedienungsanleitung des Gerätes.

Handhabungshinweise für EasyAdjust-System

Wendeplatte austauschen und einstellen

Das EasyAdjust-System ermöglicht einen gleichermaßen einfachen und schnellen Wendeplattenwechsel. Um eine Wendeplatte austauschen und μm -genau einstellen zu können, sind nur wenige Handlungsschritte nötig.



1. Den Justierkeil mit einem Innensechskantschlüssel lösen und eine halbe Umdrehung gegen den Uhrzeigersinn drehen.

Anmerkung:

Verwendung nur für geschultes Personal.



2. **Hinweis:** Zum Lösen werden zwei Innensechskantschlüssel benötigt.

Um die Spannpratze zu lösen, den Innensechskantschlüssel 1 gegen den Uhrzeigersinn und den Innensechskantschlüssel 2 im Uhrzeigersinn drehen.



3. Die Kassette zusammen mit dem Justierkeil nach vorne in Richtung Werkzeug andrücken.



4. Die Wendeplatte aus der Kassette entnehmen.

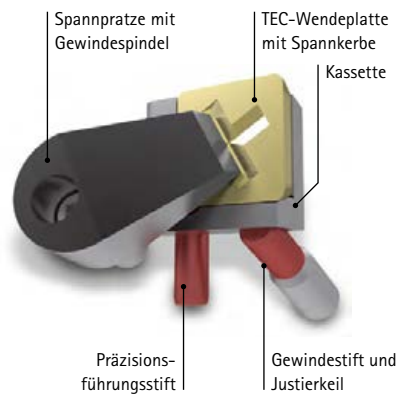
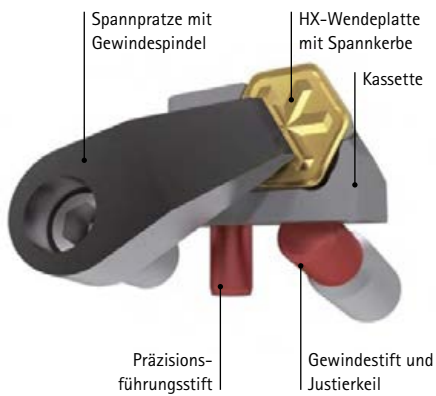

5. Die Wendeplatte austauschen oder drehen. Anschließend die Wendeplatte in die Kassette einsetzen.



6. **Hinweis:** Zum Anziehen werden zwei Innensechskantschlüssel benötigt.

Um die Spannpratze anzuziehen, den Innensechskantschlüssel 1 im Uhrzeigersinn und den Innensechskantschlüssel 2 gegen den Uhrzeigersinn drehen.

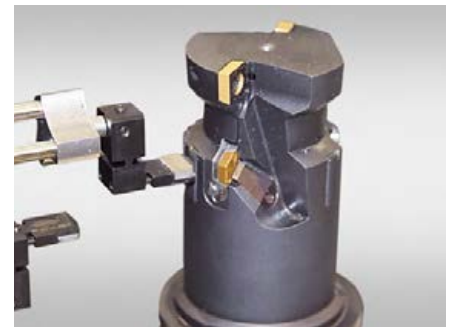

7. **Hinweis:** Entweder mit der Überstandsmessung oder der Absolutmessung fortfahren.

Das Werkzeug in die Aufnahme eines Einstellgerätes einspannen. Mit dem Messtaster den höchsten Punkt der Führungsleiste anfahren und an diesem Punkt den Messwert abnullen.

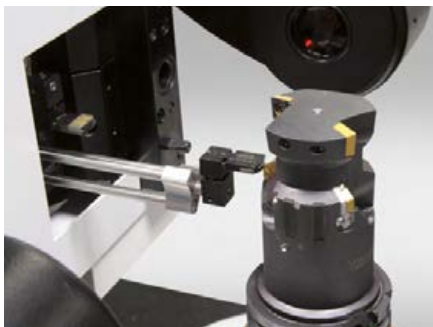

8. Mit dem Messtaster den höchsten Punkt der Wendeplatte anfahren.



9. Das Überstands- oder Absolutmaß der Wendeplatte einstellen, hierzu mit einem Innensechskantschlüssel den Gewindestift im Uhrzeigersinn drehen.

Ergebnis:

Das gewünschte Überstands- oder Absolutmaß der Wendeplatte ist eingestellt.

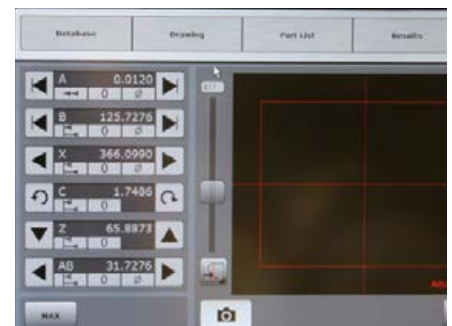

Montage- und Einstellanleitung für Außenreibahle mit EA-System



Wendeplatte wechseln

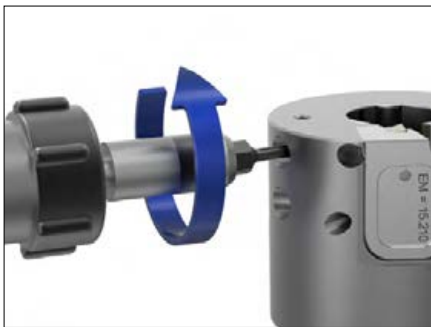

1. Beide TORX-Befestigungsschrauben gegen den Uhrzeigersinn drehen und die Kassette entnehmen.



2. Die Wendeplatte auf Grundeinstellung zurücksetzen: Justierschraube mit einer halben Umdrehung gegen den Uhrzeigersinn zurückdrehen.



3. Gewindespindel 1,5 Umdrehungen gegen den Uhrzeigersinn drehen.



4. TEC-Wendeplatte entnehmen. Wendeplattensitz und TEC-Wendeplatte säubern.

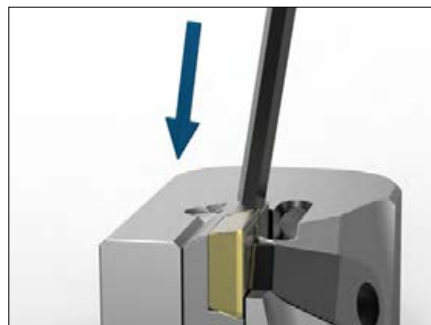

5. Neue oder gedrehte Wendeplatte in Wendeplattensitz einsetzen, dabei auf den axialen und radialen Druck achten. Wendeplattenkassette leicht gegen die Verstellrichtung zurückdrücken.

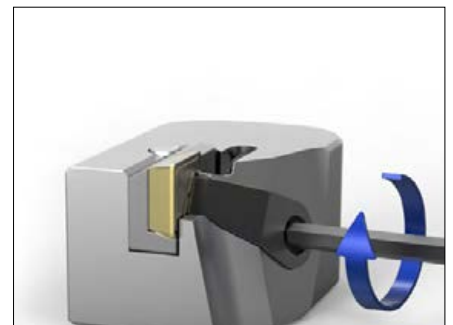

6. Gewindespindel der Spannpratze handfest im Uhrzeigersinn anziehen.

Wendeplatte einstellen



7. Das Endmaß entsprechend der Beschriftung auf der Kassette einstellen und den Taster auf Null setzen.



8. Taster auf dem höchsten Punkt der TEC-Wendeplatte ansetzen.
Justierschraube im Uhrzeigersinn drehen, bis der Zeiger der Messuhr auf Null steht.

Montage



9. Kassette in Kassettensitz einsetzen. Beide TORX-Befestigungsschrauben leicht festziehen. Anschließend Torx-Befestigungsschrauben mit 2,8 Nm anziehen.

Troubleshooting für Feinbohrwerkzeuge und Feste Reibahlen

Bohrung unrund – unregelmäßig

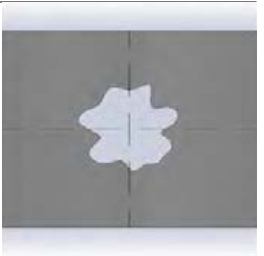
Ursachen		Lösung	
Feinbohrwerkzeug	Mehrschneidige Reibahle		
Überstand zu groß eingestellt	-	Werkzeugeinstellung überprüfen / einstellen	
-	f_z zu klein / v_c zu groß	Schnittwerte anpassen, (Empfehlung siehe Katalog)	
Voreilung zu groß		Voreilung prüfen	

Bohrung unrund – wiederholend

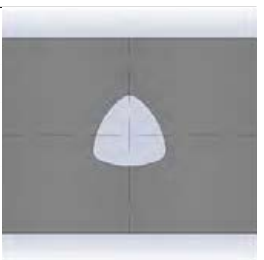
Ursachen		Lösung	
Feinbohrwerkzeug	Mehrschneidige Reibahle		
Bauteil verspannt (Polygon typisch Backenfutter)		Aufspannung / Spanndruck prüfen	
Bauteil mit unsymmetrischen Querschnitten		Schnittdruck reduzieren (Verjüngung größer, Zähnezahl kleiner, Anschnitt steiler, Vorschub kleiner)	

Bohrung zu groß

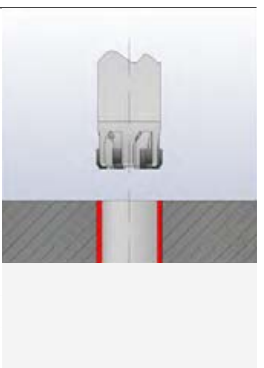
Ursachen		Lösung	
Feinbohrwerkzeug	Mehrschneidige Reibahle		
Rundlauffehler zu groß		Rundlauf prüfen / Ausrichtadapter verwenden	
schlechte Positionierung		Bohrungsposition überprüfen	
Aufbauschneide		v_c erhöhen, Kühlschmierstoff prüfen / Schneidstoffeignung prüfen / Anschnitteignung überprüfen (Empfehlung siehe Katalog)	
Vibrationen / Rattern		Schnittparameter / Aufmaß anpassen (Empfehlung siehe Katalog)	
Überstand zu groß	-	Einstelldurchmesser prüfen / korrigieren	
-	Werkzeugdurchmesser nicht in Ordnung	Durchmesser überprüfen	

Bohrung zu klein

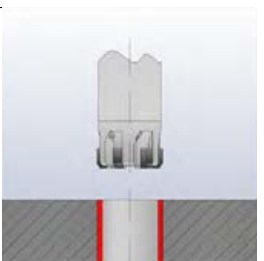
Ursachen		Lösung	
Feinbohrwerkzeug	Mehrschneidige Reibahle		
Schneide / Schneiden verschlissen		Erneuern / Nachschleifen	
Schnitttiefe a_p prüfen (Vorbearbeitung)		Schnitttiefe anpassen, Empfehlung siehe Katalog	
Dünnwandigkeit Bauteil (elastische Verformung des Bauteils)		Schnittkräfte reduzieren (Verjüngung erhöhen, Zähnezahl reduzieren, Anschnitt steiler, Vorschub kleiner)	
Überstand zu klein	-	Einstellung überprüfen / nachstellen	

Bohrungseintritt konisch | Bohrungsausritt konisch

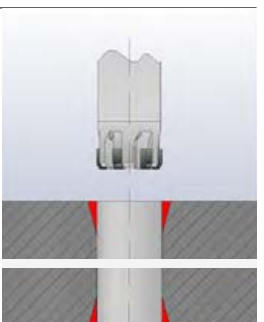
Ursachen		Lösung	
Feinbohrwerkzeug	Mehrschneidige Reibahle		
Rundlauffehler zu groß		Rundlauf prüfen / Ausrichtadapter verwenden	
Positionierungsproblem / Achsversatz		Position Vorbearbeitung bzw. Geradheit der Achse prüfen	
-	Überfahrbetrag zu groß	max. Anschnittlänge +1 mm am Bohrungsausritt überfahren	
Voreilung zu groß	-	Voreilung prüfen	
KSS Druck zu groß		KSS-Druck reduzieren	

Bohrungsoberfläche nicht in Ordnung – unregelmäßig

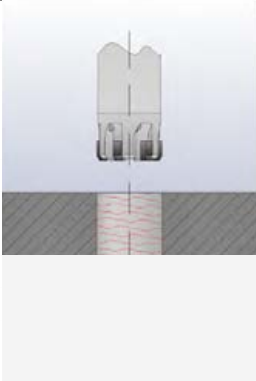
Ursachen		Lösung	
Feinbohrwerkzeug	Mehrschneidige Reibahle		
Aufbau / Ausbrüche		Prüfen, gegebenenfalls Werkzeug/Schneiden erneuern Schnittwerte siehe Katalogempfehlung	
Aufmaß zu gering		Vorbearbeitung und Aufmaß prüfen	
mangelnde Schmierung / Kühlung		KSS- / MMS-Versorgung und Ölgehalt prüfen KSS- / Additive Eignung für diese Bearbeitung prüfen	
Spanabfuhr gestört Verschleiß		KSS-Druck erhöhen / Schneidengeometrie anpassen Schneiden / Werkzeug ersetzen	
Unwucht		Kombination Aufnahme / Adapter und Werkzeug auf ausreichende Auswuchtung prüfen	

Bohrungsoberfläche nicht in Ordnung – regelmäßig

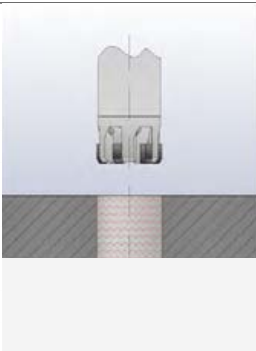
Ursachen		Lösung	
Feinbohrwerkzeug	Mehrschneidige Reibahle		
Achsversatz / falsche Positionierung		Bohrungsversatz und Position prüfen	
f_z zu klein / v_c zu groß		Schnittwerte anpassen (Empfehlung siehe Katalog)	
kritisches Durchmesser-/Längenverhältnis		Kritisches Durchmesser-/Längenverhältnis prüfen	
Einflüsse Spindel und Antriebseinheit		Schnittparameter ändern Anschnitteignung überprüfen (Empfehlung siehe Katalog)	
Unwucht		Ist die Kombination Aufnahme / Adapter und Werkzeug ausreichend gewuchtet ?	
Verjüngung zu klein		prüfen / einstellen	
Überstand zu groß		prüfen / einstellen	

Bohrungsverlauf / Zylinderform nicht in Ordnung

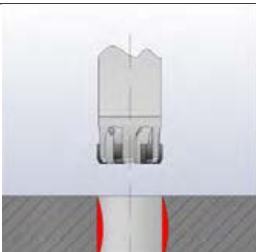
Ursachen		Lösung	
Feinbohrwerkzeug	Mehrschneidige Reibahle		
Vorbearbeitung fehlerhaft		Rücksprache Fachabteilung / Produktspezialist überprüfen / einstellen	
Anschnittgeometrie bzw. Werkzeug nicht geeignet		Rücksprache Fachabteilung / Produktspezialist	
Bearbeitungsstrategie nicht geeignet		Rücksprache Fachabteilung / Produktspezialist	

Anschnitt bricht komplett aus – generell Rücksprache mit einem Produktspezialisten/MAPAL Mitarbeiter

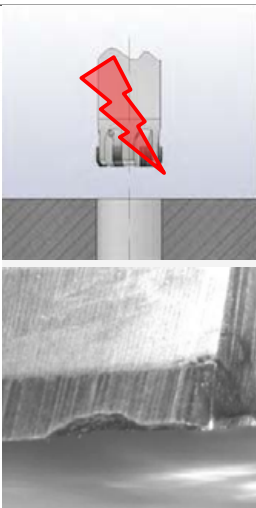
Ursachen		Lösung	
Feinbohrwerkzeug	Mehrschneidige Reibahle		
Spanabfuhr		KSS-Druck erhöhen / Schneidengeometrie	
Verjüngung zu groß / klein		prüfen / einstellen	
Aufmaß a_p zu groß		prüfen / anpassen	
Verschleiß zu hoch		Schneiden / Werkzeug ersetzen	
Vibrationen		Ursache ermitteln und abstellen	
Schnittwerte nicht in Ordnung		Schnittwerte anpassen (Empfehlung siehe Katalog)	
Voreilung zu groß		Voreilung gegebenenfalls reduzieren	

Allgemeine Zerspanungsformeln Aufbohren

Geschwindigkeit und Vorschub

Drehzahl	$n = \left[\frac{1}{\text{min}} \right]$	$n = \frac{v_c \cdot 1000}{\pi \cdot D_c}$
Schnittgeschwindigkeit	$v_c = \left[\frac{\text{m}}{\text{min}} \right]$	$v_c = \frac{\pi \cdot D_c \cdot n}{1000}$
Vorschubgeschwindigkeit	$v_f = \left[\frac{\text{mm}}{\text{min}} \right]$	$v_f = f_z \cdot z \cdot n$
Vorschub/Zahn	$f_z = \left[\text{mm} \right]$	$f_z = \frac{v_f}{z \cdot n}$
Vorschub	$f = \left[\text{mm} \right]$	$f = f_z \cdot z$
Anzahl der Schneiden	z	

Schnittkraft

Schnittkraft F_c	$F_c = A \cdot k_c = b \cdot h \cdot k_c$	F_c in N k_c in N/mm ²
Spezifische Schnittkraft	$k_c = \left[\frac{k_c \cdot 1.1}{h \cdot mc} \right]$	

Spanungsgrößen beim Aufbohren

Neben der spezifischen Schnittkraft des Werkstoffs bestimmt der Spanungsquerschnitt A im Wesentlichen die Zerspankraft. Der Vorschubanteil pro Schneide f_z und die Schnitttiefe a_p sind hier wesentliche Größen.

Es gelten folgende Zusammenhänge:

Vorschub	$f = [\text{mm}]$	$f = f_z \cdot z$
Einstellwinkel	$\kappa = [^\circ]$	$\kappa = \frac{\sigma}{2}$
Spanungsbreite	$b = [\text{mm}]$	$b = \frac{a_p}{\sin \kappa}$
Spanungsdicke	$h = [\text{mm}]$	$h = f_z \cdot \sin \kappa$
Schnitttiefe	$a_p = [\text{mm}]$	$a_p = \frac{(D - d)}{2}$

Die Abbildung zeigt den Spanungsquerschnitt A beim Aufbohren.

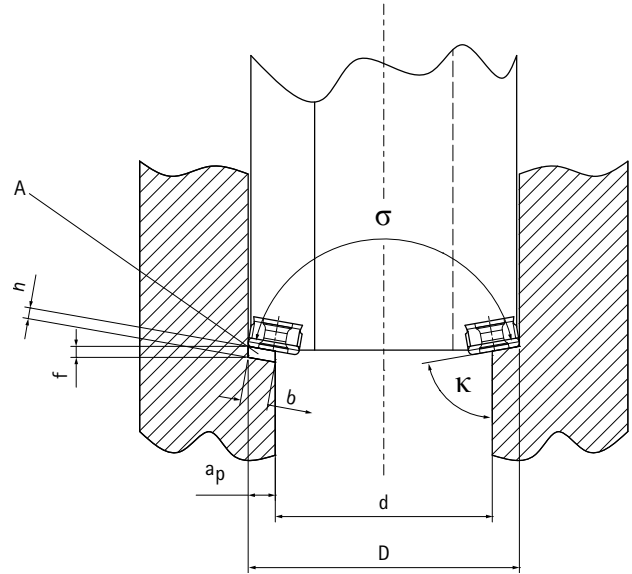

Spanungsquerschnitt für das Aufbohren	$A = [\text{mm}^2]$	$A = \frac{(D - d) \cdot f_z}{2}$	oder	$A = a_p \cdot f_z$
---------------------------------------	---------------------	-----------------------------------	------	---------------------

Schnittkraftberechnung Aufbohren

Vereinfacht

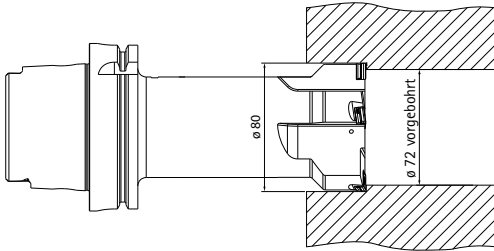

Berechnungsbeispiel:

Aufbohrwerkzeug $\varnothing 80$ mm;
 $Z = 5$; vorgebohrter $\varnothing 72$ mm, $\kappa = 90^\circ$

Werkstoff: EN-GJL-250
 $k_{c1.1}^* = 1160$, $M_c = 0,26$
 $v_c = 200$ m/min, $f_z = 0,2$ mm
 Stumpfung 30 %

	Grundformel	Berechnung	Ergebnis
1. Drehzahl	$n = \frac{v_c \cdot 1000}{\pi \cdot D}$	$n = \frac{200 \cdot 1000}{\pi \cdot 80}$	$n = 800$ 1/min
2. Schnitttiefe	$a_p = \frac{(D - d)}{2}$	$a_p = \frac{(80 - 72)}{2}$	$a_p = 4$ mm
3. Spanquerschnitt	$A = a_p \cdot f \cdot z$	$A = 4 \text{ mm} \cdot 0,2 \text{ mm} \cdot 5$	$A = 4$ mm ²
4. Spannungsdicke	$h = f_z \cdot \sin \kappa$	$h = 0,2 \text{ mm} \cdot \sin 90^\circ$	$h = 0,2$ mm
5. Spezifische Schnittkraft ohne Stumpfungsfaktor	$k_c = \frac{k_{c1.1}}{h^{m_c}}$	$k_c = \frac{1160}{0,2^{0,26}}$	$k_c = 1763$ N/mm ² mit 30% Stumpfung: $1763 \text{ N/mm}^2 \times 1,3 = 2292 \text{ N/mm}^2$
6. Schnittkraft	$F_c = A \cdot k_c = b \cdot h \cdot k_c$	$F_c = 4 \text{ mm}^2 \cdot 2292 \text{ N/mm}^2$	$F_c = 9,17$ kN
7. Schnittmoment <small>d_m = gemittelter Durchmesser in Metern</small>	$M_c = F_c \cdot \frac{d_m}{2}$	$M_c = 9167,3 \text{ N} \cdot \frac{0,076 \text{ m}}{2}$	$M_c = 348,3$ Nm
8. Schnittleistung	$P_c = \frac{2 \cdot \pi \cdot n \cdot M_c}{60s}$	$P_c = \frac{2 \cdot \pi \cdot 800 \text{ min}^{-1} \cdot 348,3 \text{ Nm}}{60s}$	$P_c = 29,2$ kW

Auswahl Werkzeugmaschine

Vergleich mit Drehmoment und Leistung der Werkzeugmaschine

Nachfolgend zwei Drehzahl/Leistungsdiagramme.

In Abhängigkeit von der Maschine sind Zähnezahl und Schnittparameter festzulegen.

Im Berechnungsbeispiel ist die Maschine mit der Motorspindel nicht geeignet, da hier bei einer Drehzahl von 800 min^{-1} nur ein Drehmoment von 187 Nm und eine Leistung von ca. 20 kW erreicht werden (Abbildung 1).

Lösung:

Entweder Zähnezahl reduzieren, Schnittgeschwindigkeit und Vorschub reduzieren, Schnitt in zwei Werkzeuge aufteilen oder stärkere Maschine wählen (z. B. mit Getriebespindel, Abbildung 2).

Motorspindel (Abbildung 1)

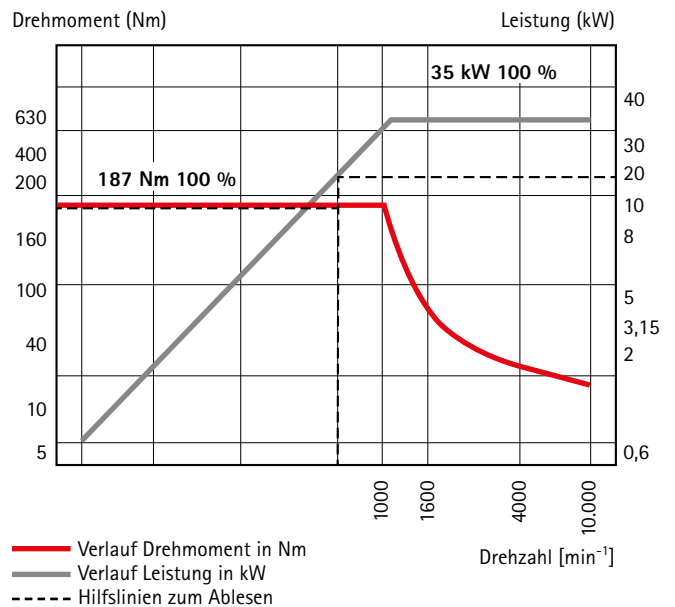

Getriebespindel (Abbildung 2)

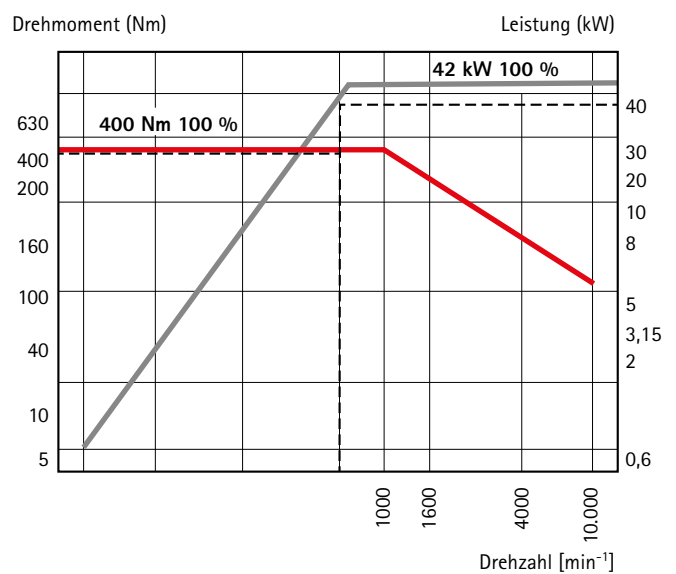

Richtwerte der Mindestaufbohrdurchmesser – Radial

In Abhängigkeit von Zähnezahl und Wendeschneidplatte

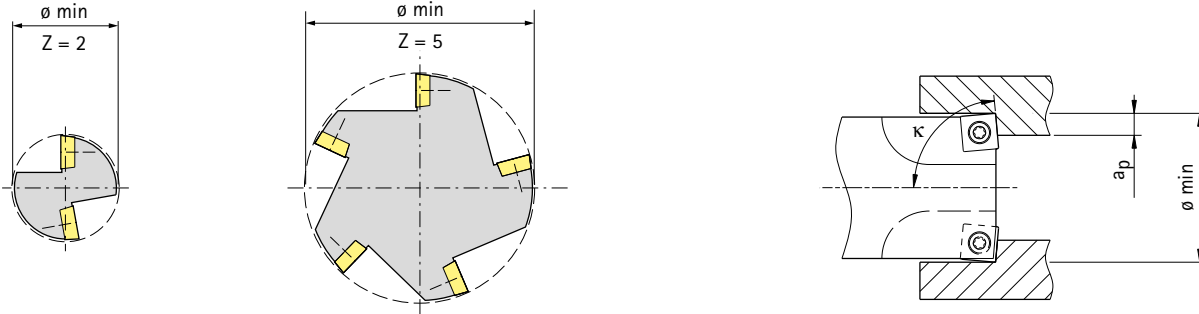

Radiale Aufbohrschneiden ohne Bogenschliff

WSP-Form	WSP-Größe				Zähnezahl	Bemerkung
	0603	09T3	1204			
S (90°)	Mindest-Aufbohrdurchmesser bei κ 85°					Geeignet für Durchgangsbohrung
	17	25	28		1	
	17	25	31		2	
	23	32	39		3	
	31	43	53		4	
	51	63	73		5	
C (80°)	0602	09T3	1204			Geeignet für 90°-Schulterbearbeitung
	Mindest-Aufbohrdurchmesser bei κ 90°					
	17	24	28		1	
	18	26	33		2	
	23	34	41		3	
	31	45	54		4	
49	63	77		5		
T (60°)	06T1	0902	1102	16T3		Bedingt geeignet für Durchgangsbohrungen und 90°-Schulterbearbeitung
	Mindest-Aufbohrdurchmesser bei κ 90°					
	15	17	17	24	1	
	18	21	24	37	2	
	21	25	28	43	3	
	27	34	37	57	4	
37	51	67	76	5		

Richtwerte der Mindestaufbohrdurchmesser – Tangential

In Abhängigkeit von Zähnezahl und Wendeschneidplatte

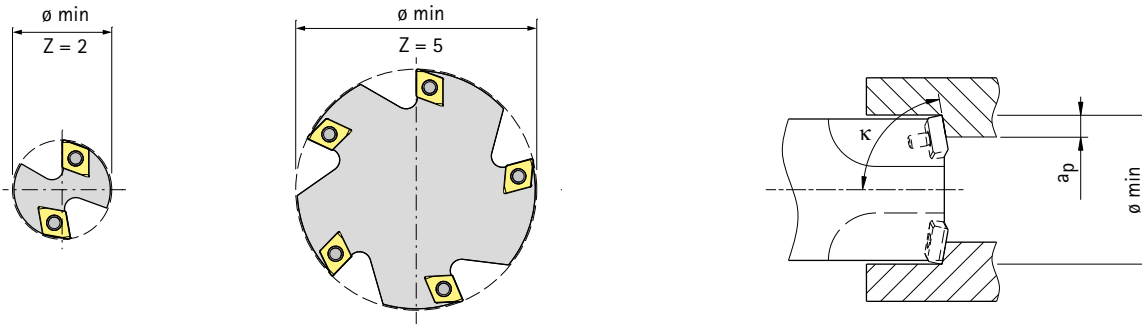

Tangentiale Aufbohrschneiden ohne Bogenschliff

WSP-Form	WSP-Größe			Zähnezahl	Bemerkung
	0603/0604	09T3/0905	1204/1206		
C (80°)	Mindest-Aufbohrdurchmesser bei κ 80° und 90°				Geeignet für Durchgangsbohrung und 90°-Schulterbearbeitung
	28	41	54	1	
	28	41	54	2	
	30	41	54	3	
	40	56	64	4	
	59	84	94	5	

Tangentiale Aufbohrschneiden mit Bogenschliff

WSP-Form	WSP-Größe			Zähnezahl	Bemerkung
	0604	0905	1206		
C (80°)	Mindest-Aufbohrdurchmesser bei κ 80° und 90°				Geeignet für Durchgangsbohrung und 90°-Schulterbearbeitung
	40	65	78	1	
	40	65	78	2	
	40	65	78	3	
	41	65	78	4	
	64	86	102	5	

Tangentiale Aufbohrschneiden mit und ohne Bogenschliff

WSP-Form	WSP-Größe			Zähnezahl	Bemerkung
	0604	0905	1206		
F (70°)	Mindest-Aufbohrdurchmesser bei κ 80° und 90°				Geeignet für Durchgangsbohrung und 90°-Schulterbearbeitung
	22	30	40	1	
	22	30	40	2	
	31	43	53	3	
	42	56	67	4	
	64	83	99	5	

Troubleshooting

Verschleißformen an Wendeschneidplatten

Verschleißform

Freiflächenverschleiß

tangential



radial

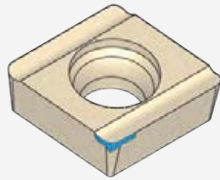

Kolkverschleiß

tangential



radial

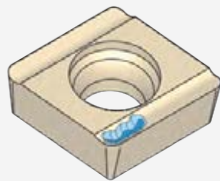

Kerbverschleiß

tangential



radial

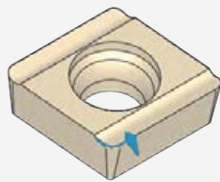

Aufbauschneide

tangential

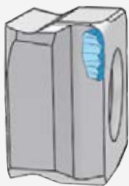

radial

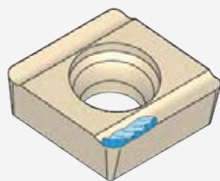

Ausbrüche

tangential

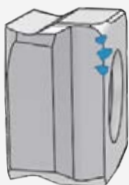

radial

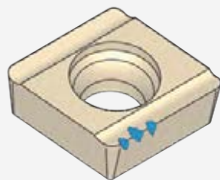

Schneidenbruch

tangential

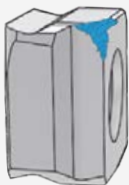

radial

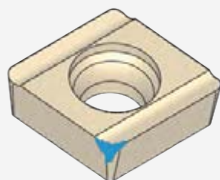

Abhilfemaßnahmen

- Schnittgeschwindigkeit reduzieren
- Verschleißfestere Schneidstoffsorte wählen

- Vorschub reduzieren
- Schnittgeschwindigkeit reduzieren
- Verschleißfestere Schneidstoffsorte wählen
- Kühlmittel einsetzen

- Schnittgeschwindigkeit reduzieren
- Kleineren Einstellwinkel wählen
- Vorschub reduzieren

- Schnittgeschwindigkeit erhöhen
- Vorschub erhöhen
- Leichtschneidende Geometrie (scharfe Schneiden) wählen

- Schnittgeschwindigkeit erhöhen
- Vorschub reduzieren
- Zähere Hartmetallsorte wählen
- Stärkere Geometrie wählen
- Stabilität verbessern (zum Beispiel kurzes Werkzeug)
- Kühlung, kontinuierlich oder trocken (Thermoschock vermeiden)

- Vorschub reduzieren
- Schnitttiefe reduzieren
- Stärkere Geometrie der Wendeschneidplatte wählen
- Zähere Hartmetallsorte wählen
- Dickere Schneidplatte wählen

Aus der Praxis - Fehlerbehebung beim Aufbohren



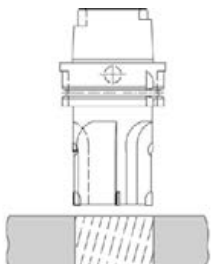
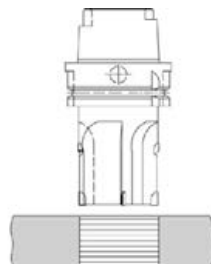
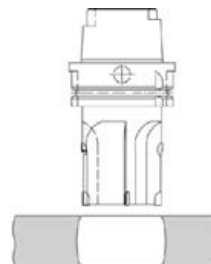























Bohrung wird zu groß	Bohrung wird zu klein	Bohrung wird konisch	Schlechte Oberfläche in der Bohrung
<p>Ursache?</p> <ul style="list-style-type: none"> - Werkzeugdurchmesser eventuell zu groß - Schnittgeschwindigkeit zu hoch - Vorschub zu hoch - Rundlauffehler zu groß - Anschnitt ungleichmäßig - Kühlschmierstoff ungeeignet 	<p>Ursache?</p> <ul style="list-style-type: none"> - Werkzeug verschlissen - Schnittgeschwindigkeit zu gering - Vorschub zu gering - Werkstoff duktil, zieht sich nach Bearbeitung zusammen - Aufmaß zu gering 	<p>Ursache?</p> <ul style="list-style-type: none"> - Rundlauffehler zu groß - Anschnitt nicht in Ordnung - Vorbearbeitung nicht in Ordnung 	<p>Ursache?</p> <ul style="list-style-type: none"> - Kühlschmierstoff ungeeignet - Aufbau an der Schneide - Werkzeug stumpf, eventuell Ausbruch an der Schneide - Spanabfuhr schlecht - Restunwucht zu groß
			

Bohrung hat Rattermarken	Bohrung zeigt Vorschubriefen	Bohrung wird ballig
<p>Ursache?</p> <ul style="list-style-type: none"> - Aufbau an der Schneide - Werkzeug stumpf - Kühlschmierstoff ungeeignet - Rundlauffehler zu groß - Restunwucht zu groß - Aufspannung nicht in Ordnung 	<p>Ursache?</p> <ul style="list-style-type: none"> - Werkzeug stumpf, eventuell Ausbruch an der Schneide - Aufbau an der Schneide - Kühlschmierstoff ungeeignet 	<p>Ursache?</p> <ul style="list-style-type: none"> - Werkstück nicht korrekt gespannt
		















Piktogramme



Vollbohren >

	Vollbohren		Anbohren		Stufenbohren		Tiefbohren
	Bohrreiben H7		Hochvorschubbearbeitung HFC		Hochgeschwindigkeitsbearbeitung HSC		Paketbohren
	Querbohren		Schräger Bohrungseintritt		Schräger Bohrungsausritt		Ebener Bohrungsgrund 180°
	Gewindekernloch		Pilotbohrung		Maximale Erreichbare Bohrungstoleranz $\geq IT7$		Vorzugsbaureihe in H7
	Toleranz Werkzeugschleifdurchmesser Grind		Maximale Bohrtiefe 3xD		Kühlmittelezufuhr		Trennstelle CFS
	Mit Wendschneidplatte		Trennstelle QTS		Trennstelle TTS-100		Trennstelle TTS-300
	Schaftform HA nach DIN HA DIN 6535		Schaftform HB nach DIN HB DIN 6535		Schaftform HE nach DIN HE DIN 6535		

Reiben und Feinbohren >

	Durchgangsbohrung		Grundbohrung		HFS-Axial-Spannsystem		HFS-Radial-Spannsystem
	Vorzugsbaureihe in H7 H7		Maximale Erreichbare Bohrungstoleranz $\geq IT7$		Toleranz Werkzeugschleifdurchmesser Grind		Einschneiden-Reibahle
	WP-Wendeplatte WP		Kühlmittelezufuhr		Trennstelle HFS		Trennstelle Modul
	Trennstelle HSK-A HSK-A		Trennstelle Morsekonusschaft (MK) MK		Zylinderschaft HA nach DIN HA DIN 6535		Schaftform HE nach DIN HE DIN 6535
	Zylinderschaft mit Spannfläche						

Senken >

	Kegelsenker nach DIN DIN 335 C		90°-Senkung
---	-----------------------------------	---	-------------

Konfiguration >

	Produkt mit konfigurierbaren Merkmalen CONFIG
---	--

Piktogramme

Produktklasse >



Basic Line:
Universalwerkzeuge, breites Anwendungsgebiet, niedrige Anschaffungskosten





Performance Line:
Hochleistungswerkzeuge, breites Anwendungsgebiet, hohe Produktivität in der Serienfertigung



Expert Line:
Spezialistenwerkzeuge für ausgewählte Anwendungen, maximale Präzision und Produktivität

Materialeignung >

 Bestens geeignet

 Bedingt geeignet

Bsp. Standard Materialeignungstabelle

P	1	2	3	4	5	6	M	1	2	3	K	1	2	3	N	1	2	3	4	S	1	2	3	4	5	H	1	2	3
	■	■	■	■			■				■	■	■								■								

Bsp. Materialeignungstabelle für Nichteisenmetalle und Leichtbauwerkstoffe

N	1.1	1.2	1.3	1.4	2.1	2.2	2.3	3.1	4.1	4.2	4.3	G	1.1	1.2	1.3	2.1	3.1	4.1	4.2	5.1	5.2	5.3
										■		■			■			■	■			

MAPAL Zerspanungsgruppen

Zerspanungsgruppe	Werkstoff	Festigkeit/Härte [N/mm ²] [HRC]	Häufig bearbeitete Werkstoffe
P	P1.1	Bau-, Automaten-, Einsatz- und Vergütungsstähle, unlegiert	< 700 N/mm ² 1.0122 (S235/St 37), 1.0401 (C15), 1.0503 (C45), 1.0570 (S355/St 52), 1.1213 (Cf53)
	P1.2	Bau-, Automaten-, Einsatz- und Vergütungsstähle, unlegiert	< 1200 N/mm ² 1.1249 (Cf70)
	P2.1	Nitrier-, Einsatz- und Vergütungsstähle, legiert	< 900 N/mm ² 1.7131 (16MnCr5)
	P2.2	Nitrier-, Einsatz- und Vergütungsstähle, legiert	< 1400 N/mm ² 1.7227 (42CrMoS4)
	P3.1	Werkzeug-, Wälzlager-, Feder- und Schnellarbeitsstähle*	< 800 N/mm ² 1.2343 (X37CrMoV5-1), 1.2762 (75CrMoNiW6-7)
	P3.2	Werkzeug-, Wälzlager-, Feder- und Schnellarbeitsstähle*	< 1000 N/mm ² 1.2367 (X38CrMoV5-3), 1.2713 (55NiCrMoV6)
	P3.3	Werkzeug-, Wälzlager-, Feder- und Schnellarbeitsstähle*	< 1500 N/mm ² 1.2379 (X153CrMoV12) 1.2738 (40CrMnNiMo8-6-4)
	P4	P4.1 Rostfreie Stähle, ferritisch und martensitisch	1.4510 (X3CrTi17), 1.4589 (X5CrNiMoTi15-2)
P5	P5.1 Stahlguss	1.7231 (G42CrMo4)	
P6	P6.1 Rostfreier Stahlguss, ferritisch und martensitisch		
M	M1.1	Rostfreie Stähle, austenitisch	< 700 N/mm ² 1.4301 (V2A), 1.4571 (V4A)
	M1.2	Rostfreie Stähle, ferritisch/austenitisch (Duplex)	< 1000 N/mm ² 1.4362 (Alloy 2304), 1.4501, 1.4662 (LDX 2404)
	M2	M2.1 Rostfreier Stahlguss, austenitisch	< 700 N/mm ²
	M3	M3.1 Rostfreier Stahlguss, ferritisch/austenitisch (Duplex)	< 1000 N/mm ²
K	K1.1	Gusseisen mit Lamellengraphit (Grauguss), GJL	< 300 N/mm ² GJL-250 (GG-25), GJL-260 (GG-26 Cr)
	K2.1	Gusseisen mit Kugelgraphit, GJS	< 500 N/mm ² GJS-400 (GGG-40), GJS-450 (GGG-45)
	K2.2	Gusseisen mit Kugelgraphit, GJS	≤ 800 N/mm ² GJS-600 (GGG-60), GJS-800-2 (GGG-80), GJS-800-8 (ADI 800)
	K2.3	Gusseisen mit Kugelgraphit, GJS	> 800 N/mm ² GJS-900-2 (GGG-90), GJS-1000-5 (ADI 1000), GJS-1200-2 (ADI 1200), GJS-1400-1 (ADI 1400)
	K3.1	Gusseisen mit Vermiculargraphit, GJV; Temperguss, GJM	< 500 N/mm ² GJV-300, GJV-400, GJMw-400-5 (GTW-40)
	K3.2	Gusseisen mit Vermiculargraphit, GJV; Temperguss, GJM	> 500 N/mm ² GJV-500, GJV-700
N	N1.1	Aluminium, unlegiert und legiert < 3 % Si	Alloy 2024, Alloy 7075, Al99
	N1.2	Aluminium, legiert ≤ 7 % Si	AlSi7
	N1.3	Aluminium, legiert > 7-12 % Si	AlSi9, AlSi9Cu
	N1.4	Aluminium, legiert > 12 % Si	AlSi12, AlSi17
	N2.1	Kupfer, unlegiert und niedriglegiert	< 300 N/mm ² SE-Cu
	N2.2	Kupfer, legiert	> 300 N/mm ² CuSn6
	N2.3	Messing, Bronze, Rotguss	< 1200 N/mm ² CuZn33, CuAl9Mn3
	N3.1	Graphit, > 8 µm	
	N3.2	Graphit, ≤ 8 µm	
	N4	N4.1 Kunststoff, Thermoplaste	PA, PE, PC, PS, PVC, PP, PTFE, POM, PMMA
N4.2	Kunststoff, Duroplaste	PU, PF, EP, UP, VE, CR	
N4.3	Kunststoff, Schaumstoffe	EPS, PUR, PVC-E, PS-E, PP-E	
C	C1.1	Kunststoffmatrix, Aramidfaserverstärkt (AFK)	Nomex, Kevlar, Twaron, KOREX
	C1.2	Kunststoffmatrix (duroplastisch), CFK/GFK	IMS, HTA
	C1.3	Kunststoffmatrix (thermoplastisch), CFK/GFK	GMT-PP, PEEK
	C2	C2.1 Kohlenstoffmatrix, Kohlenstofffaserverstärkt (CFC)	CF222, CF225, CF226, CF227, CF260
	C3	C3.1 Metallmatrix (MMC)	CeramTec AO-403 (AlSi9MgMn-Al2O3), Al/Cu/Mg-SiO2/Al2O3/AlN/TiC/SiC/BN/TiB2
	C4	C4.1 Sandwichkonstruktion, Wabenkern (Honeycomb)	
	C4.2	Sandwichkonstruktion, Schaumkern	PLASCORE PAMG-XR1 5052, PCGA-XR1 3003, PAMG-XR1 5056, Micro-Cell (core made of Alloy 5052/5056)
	C5	C5.1 Schichtverbund (Stack), Nichtmetall-Nichteisenmetall-Verbund	CFK-Aluminium, IMS/HTA + Alloy 2024/6061/7075
	C5.2	Schichtverbund (Stack), Nichtmetall-Metall-Verbund	CFK-Titan, IMS/HTA + TiAl6V4/AMS4905
	C5.3	Schichtverbund (Stack), Nichtmetall-Nichtmetall-Verbund	CFK-CFK
	C5.4	Schichtverbund (Stack), Nichteisenmetall-Nichteisenmetall-Verbund	Aluminium-Aluminium
	C5.5	Schichtverbund (Stack), Nichteisenmetall-Metall-Verbund	Aluminium-Titan
C5.6	Schichtverbund (Stack), Metall-Metall-Verbund	Titan-Inox	
S	S1	S1.1 Titan, Titanlegierungen	< 400 N/mm ²
	S2	S2.1 Titan, Titanlegierungen	< 1200 N/mm ² TiAl6V4
	S2.2	Titan, Titanlegierungen	> 1200 N/mm ²
	S3	S3.1 Nickel, unlegiert und legiert	< 900 N/mm ² 1.3912 (Invar, Ni36)
	S3.2	Nickel, unlegiert und legiert	> 900 N/mm ²
	S4	S4.1 Hochwarmfeste Superlegierung, Ni-, Co-, und Fe-basiert	Hardox, Hastelloy, Incoloy, Inconel, NIMONIC, Stellite, Waspaloy
S5	S5.1 Wolfram- und Molybdänlegierungen		
H	H1	H1.1 Gehärteter Stahl/Stahlguss	< 44 HRC 1.2738 HH, 1.2085, Toolox 33, Toolox 44
	H1.2	Gehärteter Stahl/Stahlguss	< 55 HRC 1.2343, 1.2311, 1.2312, 1.2714, 1.2083, 1.2738
	H2	H2.1 Gehärteter Stahl/Stahlguss	< 60 HRC 1.1730, 1.2379, 1.2358, 1.2767, 1.4112, ASP 2012
	H2.2	Gehärteter Stahl/Stahlguss	< 65 HRC 1.2379, 1.2363, 1.2436, 1.2842, ASP 2005, Vanadis 23
	H2.3	Gehärteter Stahl/Stahlguss	< 68 HRC ASP 2017, ASP 2023, Vanadis 30, Vanadis 60
H3	H3.1 Verschleißbeständiger Guss/Hartguss, GJN		

* Wenn die Legierungsbestandteile Cr, Mo, Ni, V, W in Summe > 8 % dann die nächst höhere MAPAL Zerspanungsgruppe wählen.

RAGOTZKY+GÄTJE

Holtener Strasse 288, 24106 Kiel | mail@ragotzkygaetje.de | 0431-389080
ragotzkygaetje.de | shop.ragotzkygaetje.de | spannsysteme-shop.de



HANS TREIBER

Gutenbergstrasse 19, 24558 Henstedt-Ulzburg | 04193-77943
mail@hanstreiber.de | shop.hanstreiber.de | fraeser-shop.de

Entdecken Sie jetzt Werkzeug- und Service-Lösungen, die Sie vorwärts bringen:

BOHRUNGSBEARBEITUNG

REIBEN | FEINBOHREN

VOLLBOHREN | AUFBOHREN | SENKEN

FRÄSEN

SPANNEN

DREHEN

AUSSTEUERN

EINSTELLEN | MESSEN | AUSGEBEN

SERVICES